

Table of Contents

- 1. Purpose
- 2. Tier Classification
- 3. Scope of Report
- 4. Methods
- 5. Property Description
- 6. General Location
- 7. Project Description
- 8. Applicable Rules and Regulations
- 9. General Compliance Goals for Control of Cultivators
- 10. Land Use, Development, and Drainage Features
  - a. Current, Historical, and Anticipated
  - b. Drainage Channel Identification and Maintenance
  - c. Wetlands and Other Sensitive Areas
  - d. Stormwater Management
  - e. Sedimentation, Erosion, and Pollution Control
  - f. Construction Erosion Control
  - g. Storage and Disposal
  - h. Annual Maintenance Measures
- 11. Treatment of Cultivators
- 12. Site Maps
- 13. Implementation Schedule
- 14. Management Responsibility
- 15. Appendix A: NPDES
- 16. Monitoring Plan
- 17. Attachments
- 18. Applicant's Technical Data
- 19. Site Management Plan
- 20. Posture

# Site Management Plan

(Tier 1, Low Risk)

**WDID - 1\_12CC419436**

**Humboldt County  
APN: 218-031-008**

*Prepared by:*



165 South Fortuna Boulevard, Fortuna, CA 95540  
 707-725-1897 • fax 707-725-0972  
 trc@timberlandresource.com

9/10/2020

## Purpose

This Site Management Plan (SMP) has been prepared on behalf of the cannabis cultivator for the Humboldt County property identified as Assessor Parcel Number 218-031-008, by agreement and in response to the State Water Resources Control Board Cannabis Cultivation Policy (Cannabis Policy), in congruence with Order WQ 2019-0001-DWQ General Waste Discharge Requirements for Discharges of Waste Associated with Cannabis Cultivation Activities (General Order). The General Order implements the Cannabis Policy requirements, specifically those requirements that address waste discharges associated with cannabis cultivation activities. Cannabis cultivators covered under the General Order are subject to the requirements of the Cannabis Policy in its entirety. The Cannabis Policy provides a statewide tiered approach for permitting discharges and threatened discharges of waste from cannabis cultivation and associated activities, establishes a personal use exemption standard, and provides conditional exemption criteria for activities with a low threat to water quality.

## Tier Designation

Tiers are defined by the amount of disturbed area. Tier 1 outdoor commercial cultivation activities disturb an area equal to or greater than 2,000 square feet and less than 1 acre (43,560 square feet). Tier 2 outdoor commercial cultivation activities disturb an area equal to or greater than 1 acre. Risk designation for Tier 1 and Tier 2 enrollees under the Cannabis Policy is based on the slope of disturbed areas and the proximity to a surface water body. Characterization is based on the risk designation summarized in Table 1 below.

**Table 1: Summary of Risk Designation**

Low Risk	Moderate Risk	High Risk
<ul style="list-style-type: none"> <li>• No portion of the disturbed area is located on a slope greater than 30 percent, and</li> <li>• All of the disturbed area complies with the setback requirements.</li> </ul>	<ul style="list-style-type: none"> <li>• Any portion of the disturbed area is located on a slope greater than 30 percent, and</li> <li>• All of the disturbed area complies with the setback requirements.</li> </ul>	<ul style="list-style-type: none"> <li>• Any portion of the disturbed area is located within the setback requirements.</li> </ul>

Thorough assessment of the project area including roads, disturbed areas, legacy features, and cultivation areas classify this enrollment into the **Tier 1, Low Risk** designation.



**Scope of Report**

Tier 1 and Tier 2 cannabis cultivators are required to submit and implement a Site Management Plan that describes how they are complying with the Requirements listed in Attachment A. The description shall describe how all applicable Best Practicable Treatment or Control (BPTC) measures are implemented. Cannabis cultivators within the North Coast Regional Water Quality Control Board jurisdiction are required to submit and implement Site Management Plans that describe how the Requirements are implemented property-wide, to include legacy activities. The SMP includes an Implementation Schedule to achieve compliance, but all work must be completed by the onset of the Winter Period each year. Projects designated as Moderate Risk are also required to have a Site Erosion and Sediment Control Plan to achieve the goal of minimizing the discharge of sediment off-site. Projects designated as High Risk are also required to have a Disturbed Area Stabilization Plan to achieve the goal of stabilizing the disturbed area to minimize the discharge of sediment off-site and comply with the setback requirements. The cannabis cultivator shall ensure that all site operating personnel are familiar with the contents of the General Order and all technical reports prepared for the property. Projects which have over one acre of cannabis cultivation (total canopy area) are also required to have a Nitrogen Management Plan to describe how nitrogen is stored, used, and applied to crops in a way that is protective of water quality. A copy of the General Order, and technical reports required by the General Order, shall be kept at the cultivation site. Electronic copies of these documents are acceptable. Either format of maintained documents kept on site must be immediately presentable upon request.

**Methods**

The methods used to develop this SMP include both field and office components. The office component consisted of aerial photography review and interpretation, existing USGS quad map review, GIS mapping of field data, review of on-site photography points, streamflow calculations, general planning, and information gathered from the cannabis cultivator and/or landowner. The field component included mapping of all access roads, vehicle parking areas, Waters of the State, stream crossings, drainage features, cultivation sites, buildings, disturbed areas, and all other relevant site features within the project area and surrounding areas (as feasible). Cultivation areas, associated facilities, roads, and other developed and/or disturbed areas were assessed for discharges and related controllable water quality factors from the activities listed in the General Order. The field assessment also included an evaluation and determination of compliance with all applicable BPTC's per Section 2 of the General Order.

**Property Description**

The property assessed consists of one parcel totaling 43 acres located approximately 9 miles south east of Harris, California, at an elevation of approximately 2,200 feet above mean sea level. The property is located in Section 11, T5S, R5E, HB&M, Humboldt County, from the Jewett Rock USGS 7.5' Quad. Unnamed Class II and III watercourses flow north-south through the property that drains to Chamise Creek, which is tributary to South Fork Eel River. The Cultivator is not currently growing cannabis on the property during the time of assessment.



# Site Management Plan

## Project General Location Map



Timberland  
Resource  
Consultants

Order WQ 2019-0001-DWQ [WDID - 1\_12CC419436]  
Section 11, T5S, R5E, Humboldt County,  
Jewett Rock 7.5' USGS Quadrangle  
TRC-461

### Map Legend

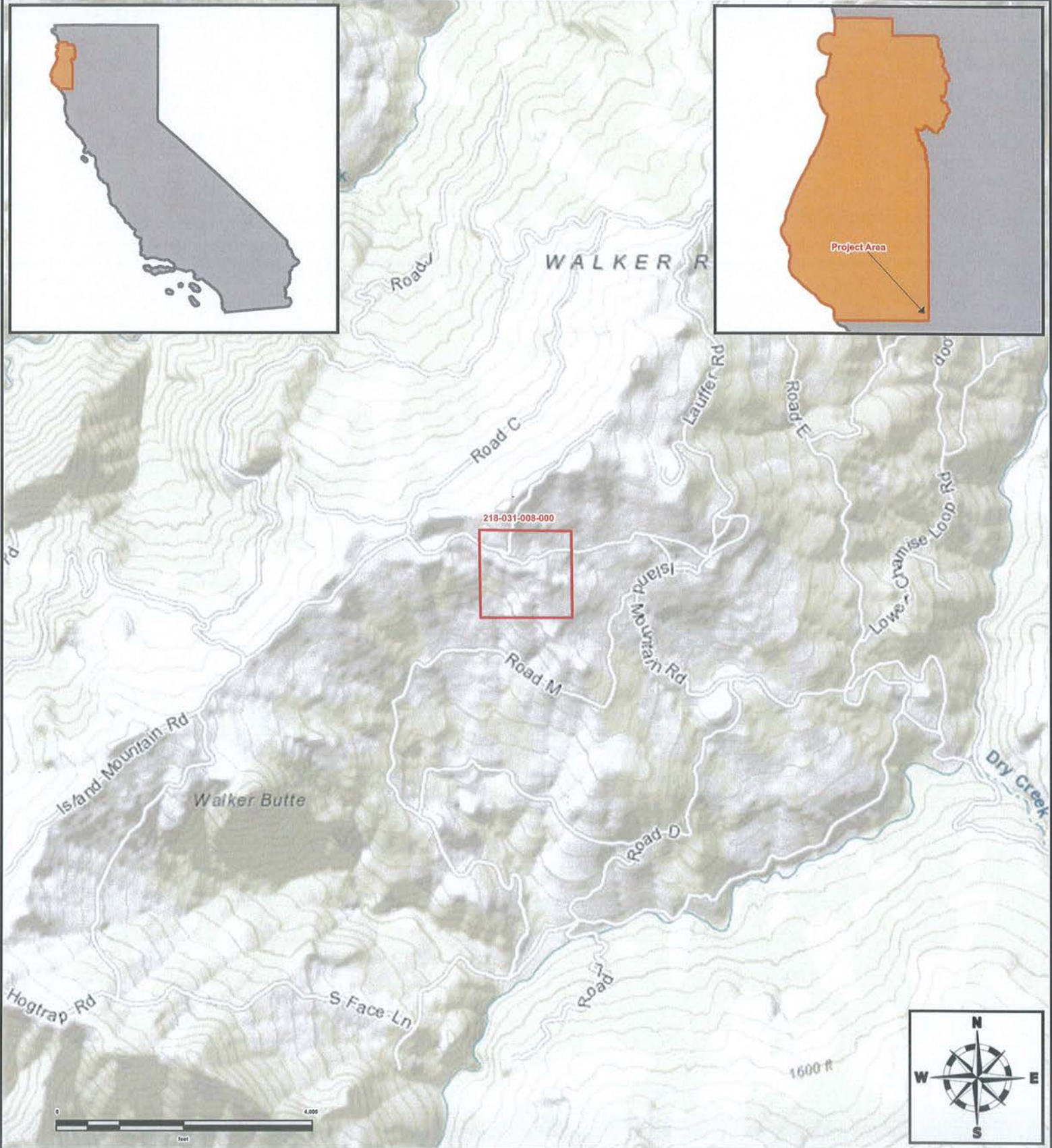



### Project Description

Cannabis cultivation on the property consists of approximately 8,200 ft<sup>2</sup> of general cultivation area<sup>1</sup>. The cultivation areas are located within 8,200 ft<sup>2</sup> of disturbed area located in two separate areas on the property. The cultivation areas are located greater than 200' from surface waters. This project is being permitted by Humboldt County to cultivate cannabis. This project was previously enrolled in the North Coast Regional Water Quality Control Board Order No. R1-2015-0023 under WDID-1B16872CHUM and has since enrolled with State Water Resources Control Board as WDID-1\_12CC419436. This project is being classified as Tier 1, Low Risk.

Table 1: Cultivation Site Parameters.

Cultivation Area	Land Disturbance Area (ft <sup>2</sup> )	General Cultivation Area <sup>1</sup> (ft <sup>2</sup> )	Adjoining Hillslopes (% Grade)
A	4,600	4,600	28
B	3,600	3,600	26
Totals:	8,200	8,200	-

<sup>1</sup> General Cultivation Area consists of the approximate cultivation area and is **not** an accurate representation of the cannabis canopy or the Cultivator's permitted cultivation area. The total cannabis canopy area may vary considerably than the land disturbance area.

Table 2: Project Permitting

Additional Required Permits Related to Project, Type, and Status	
SIUR	Small Irrigation and Use Registration Filed with Division of Water Rights – #H501881
LSAA/1600	Amendment in progress for Notification No. 1600-2018-0198-R1
401 Cert	May be required for any work in a waterbody or the riparian setback.

## Baseline Assessment of Requirements Related to Water Diversions and Waste Discharge for Cannabis Cultivation

This project was previously enrolled in the North Coast Regional Water Quality Control Board Order No. 2015-0023. A Water Resource Protection Plan (WRPP) was prepared by Pacific Watershed Associates. Some mitigations prescribed in the WRPP have since been completed. A re-assessment of the project was conducted and will be used as the baseline assessment for the preparation of this document.

This project is newly enrolled in the State Water Quality Control Board Order No. WQ 2019-0001-DWQ.

### Land Development and Maintenance, Erosion Control, and Drainage Features

Project Compliance Y /N

Roads are being classified as “permanent” (roads appurtenant to the project being used year-round), “seasonal” (roads appurtenant to the project being used primarily during summer months), “legacy” (roads not appurtenant to the project receiving little to no use), and “trail” (being used for occasional access to features on the property).

Roads within the project area appear to have a moderate native rock, and based on observations of surface erosion relative to current surface drainage break frequency, are being classified as having low erodibility. This classification will be utilized to determine surface/ditch-line drainage break frequency based on Table 19 of the Handbook for Forest Ranch and Rural Roads, 2014.

**TABLE 19. Recommended maximum rolling dip and ditch relief culvert spacing, in feet, based on road gradient and soil erodibility <sup>1,2</sup>**

Soil erodibility	Road gradient (%) and drainage structure spacing (feet)				
	0-3	4-6	7-9	10-12	>12
High to moderate	250	160	130	115	100
Low	400	300	250	200	160

Currently, all permanent roads on the property have imported rock surfacing and do not require any more rock surfacing. All seasonal roads have native surfaces and the majority of access roads, permanent and seasonal, are out-sloped with gentle gradients and adequately drained to allow surface/ditch-line water drainage. Sections of seasonal roads require the installation of new surface drainage structures. No erosion or wheel ruts were observed on the majority of access roads on the date of the site visit. See the attached photographs, Mitigation Report, Treatment Implementation Schedule, and Site Map to follow for site specific details and treatments.

No erosion was identified at the cultivation areas. If erosion begins to occur beneath the elevated planter bed of Cultivation Area A; the Cultivator shall lay an erosion preventive measure (i.e. erosion control matting or jute netting) below the elevated bed. No past cultivation areas were identified at



the time of assessment. See the attached photographs, Mitigation Report, Treatment Implementation Schedule, and Site Map to follow for site specific details and treatments.

No unstable areas or Controllable Sediment Delivery Sites (CSDS) were identified at the time of assessment.

Cleanup, Restoration, and Mitigation:

Project Compliance Y/N

Not applicable.

Stream Crossing Installation and Maintenance:

Project Compliance Y/N

Three watercourse crossings were identified during the assessment of the property. All three crossings are located on a county road Island Mountain Rd. and the maintenance of these culverts is not the Cultivator's responsibility. See attached photographs, Mitigation Report, Treatment Implementation Schedule, and Site Map to follow for site specific details and treatments.

Per the State General Cannabis Order WQ-2019-0001-DWR, a 401 Water Quality Certification from the North Coast Regional Water Quality Control Board may be required for any work in or around water bodies or within riparian setbacks. It is the responsibility of the Cultivator/Landowner to obtain all applicable permits and approvals prior to initiating any such activities.

A Lake and Streambed Alteration Agreement (LSAA/1600) with California Department of Fish & Wildlife (CDFW) needs to be amended into the new landowner's name. Any additional guidelines, treatments, or restrictions set forth under the finalized Lake and Stream Alteration Agreement shall be followed.

Soil Disposal and Spoils Management:

Project Compliance Y/N

Currently, no spoils are present on the property. Any/all spoils generated through development or maintenance of roads, driveways, earthen fill pads, or other cleared or filled areas have not been sidecast in any location where they can enter or be transported to surface waters. Any/all future spoils generated as a result of any future construction projects that are to be stored on the property shall be done so in accordance with the BTPC.

Riparian and Wetland Protection and Management:

Project Compliance Y/N

No disturbed areas were identified as being within riparian areas

Table 4: Riparian and Wetland Protection and Management

Disturbed Area	Disturbance Area Distances and Riparian Setbacks <sup>2</sup>				
	Class I [Setback: 100'] <sup>2</sup>	Class II [Setback: 100']	Class III [Setback: 50']	Perennial Spring or Wetland [Setback: 50'] <sup>2</sup>	Disturbed Area Within Setbacks [ft <sup>2</sup> ]
Cultivation Area A	>200'	>200'	>200'	>200'	0
Cultivation Area B	>200'	>200'	>200'	>200'	0
Total =					0

<sup>2</sup>This enrollment was previously enrolled in RWQCB Order No 2015-0023 and as such may retain reduced setbacks that were applicable under the previous Order.

Water Storage and Use:

Project Compliance Y/N

All water is derived from a groundwater well, one on-stream pond, and two surface water diversions located on the property. The well, on-stream pond, and surface water diversions meet and exceed the required water demands for both domestic and agricultural use. The surface water diversions (PODs) and well are used for domestic and agricultural use. At present, there are no metering devices or procedures in place to record water usage associated with the irrigation of cannabis. A metering device and/or a procedure to monitor water usage shall be used to record all water used for the irrigation of cannabis and domestic use. No matter the source or means of measurement, per the State General Order, all water used for the irrigation of cannabis shall be recorded daily and recorded water use data shall be kept and maintained for 5 years. Water use may be recorded by meter(s), calculated irrigation times, pump and fill, tank measurements, or any other reasonably accurate means. These records are to be current, maintained, kept on site, and presentable should they be requested. Monthly water usage shall be recorded for annual reporting purposes. For surface water diversions that are used at any point to provide water for the irrigation of cannabis, metering device(s) shall be installed immediately to record water diversion as it is diverted. Records of diverted surface water shall be kept and maintained for 5 years. These records are to be current, maintained, kept on site, and presentable should they be requested. If surface water is also used for domestic uses, domestic water is to be metered separately from water used for the irrigation of cannabis and is required the same recording and record keeping as water used for cannabis.

Water is stored in two 2,500-gallon tanks, four 4,000-gallon tanks, eight 3,000-gallon tanks, and twenty-one 5,000-gallon tanks. Fertilizer mixing occurs in one 500-gallon tank. Water storage tanks



were found to have lids in place to prevent access and entrapment of wildlife. Tank lids shall be kept closed at all times when access is not needed. Tanks that do not utilize lids shall be retrofitted to be enclosed from wildlife. During the assessment, water storage tanks were not seen overflowing with diverted surface waters. If overflowing occurs, overflow prevention measures shall be installed on water storage and transfer infrastructure or water storage tanks to prevent the overflowing of tanks and unnecessary waste of water resources when water storage infrastructure has filled. Water conservation measures such as drip line irrigation, morning or evening watering, and mulch or cover cropping of cultivated topsoils shall also be implemented.

At this time, the cannabis cultivator has 105,000 gallons of water storage installed. Based on estimates, this volume of storage combined with the output from the well is sufficient to allow for full forbearance during the required period from April 1st to October 31st. Any additional water storage that is needed shall be installed and filled prior to the Forbearance Period for 2021. Recorded water use data shall be used to determine remaining, or exact, storage needs to meet full forbearance. Monthly water usage estimates and the season total are as follows below. If the Cultivator is unable to store or acquire a sufficient volume of water, water will have to be purchased or acquired from an alternative legal source such as water delivery. There is no exception to the surface water diversion forbearance period from April 15<sup>th</sup> to October 31<sup>st</sup> for the irrigation of cannabis.

*Table 5: Estimated Annual Water Use*

2019	Jan	Feb	Mar	Apr	May	Jun	Jul	Aug	Sep	Oct	Nov	Dec
<b>Cannabis Irrigation</b>	0	0	0	5,000	10,000	15,000	20,000	25,000	20,000	5,000	0	0
<b>Total AG Water Use =</b>											<b>100,000</b>	

One water storage bladder without proper containment was observed during the assessment of the property. Cannabis cultivators are required to construct additional infrastructure to use bladders for water storage or it shall be decommissioned. Per Cannabis Cultivation Policy: Attachment A, Section 2, No. 88 & 89 for cannabis cultivators, bladders shall be safely contained within a secondary containment system with sufficient capacity to capture 110 percent of a bladders maximum volume in the event of bladder failure and if open to rainfall, and/or (whichever is larger) capable to accommodate precipitation and storm water inputs from 24 hours of a 25-year storm event. Secondary containment is recommended in the form of a dirt berm, containment pit, combination of both, or impermeable material with skeletal support.

There is domestic water use at this time on this property. Water meter(s), or water usage procedures, and water supply infrastructure shall be designed/installed in a manner such that water usage for the irrigation of cannabis can be recorded separately from water used for domestic use. Additionally, if there are multiple diversions of surface water, infrastructure/metering device(s) shall be designed/installed in a manner that each source of surface water is recorded separately.

A Lake and Streambed Alteration Agreement with the California Department of Fish and Wildlife, as well as an Initial Statement of Water Diversion and Use and a Small Irrigation and Use Registration with the California State Water Resource Control Board Division of Water Rights, may



require amendment to continue the use of any diversions. Any additional guidelines, treatments, or restrictions set forth under the finalized Lake and Stream Agreement shall be followed.

During visits to the property, no irrigation runoff, or evidence of such runoff, was observed at any of the cultivation areas.

Fertilizers, Soils, Pesticides, and Petroleum Products:

Project Compliance Y/N

Site 07 has a large untarped pile of potting soil located within the riparian setback that shall be relocated immediately. Fertilizers, pesticides, potting soils, compost, and other soils and soil amendments shall be stored on the property in a manner in which they will not enter or be transported into surface waters and so that nutrients or other pollutants will not be leached into groundwater. Cultivation areas are currently maintained so as to prevent nutrients from leaving the site during the growing season and post-harvest. See the Mitigation Report, Treatment Implementation Schedule, and Site Map to follow for site specific details and treatments.

Fertilizers and soil amendments shall be applied and used per the manufacturer's guidelines. The use of pesticide products shall be consistent with product labeling and all products on the property are to be stored in closed structures to ensure that they do not enter or are released into surface or ground waters.

Currently, no bulk fuel storage or petroleum products are present on the property. Fuel is stored and transferred from in-bed auxiliary fuel tanks installed onto trucks. Small quantities of fuel are also stored within fuel canisters and motor oil is stored in the original motor oil container, alongside small generators that power fertilizer mixing tanks. Neither the fuel and motor oil or the small generators have secondary containment. No large generators were present on the property on the date of inspection. Larger trailered generators shall have adequate secondary containment and if they are used during the winter period, have adequate cover from precipitation.

Any/all fuel canisters, motor oil containers, and generators (large or small) shall be stored in secondary containment (e.g. drip pans, plastic totes, or sealed metal boxes) while being stored long term or not in immediate use, wherever these materials are used anywhere on the property. See the Mitigation Report, Treatment Implementation Schedule, and Site Map to follow for site specific details and treatments.

Should the cannabis cultivator at any point in the future obtain fuel storage or petroleum products, any/all future petroleum products and other liquid chemicals, including but not limited to diesel, biodiesel, gasoline, and oils shall be stored so as to prevent their spillage, discharge, or seepage into receiving waters. Storage tanks and containers shall be of suitable material and construction to be compatible with the substance(s) stored and conditions of storage such as pressure and temperature. Above ground storage tanks and containers shall be provided with a secondary means of containment for the entire capacity of the largest single container and sufficient cover shall be



provided to prevent any/all precipitation from entering said secondary containment vessel. Cannabis cultivators shall ensure that diked areas are sufficiently impervious to contain discharged chemicals. Cannabis cultivators shall implement spill prevention, control, and countermeasures (SPCC) and have appropriate cleanup materials available onsite if the volume of a fuel container is greater than 1,320 gallons. Underground storage tanks 110 gallons and larger shall be registered with the appropriate County department and comply with state and local requirements for leak detection, spill overflow, corrosion protection, and insurance coverage. On site storage of petroleum products, or other fuels used for commercial activities may require registration as hazardous materials through the California Environmental Reporting System (CERS). Additionally, any waste oil generated from commercial activities (generators) is considered by the state hazardous waste and requires additional reporting. This cannabis cultivator is advised to contact local agencies to find out if such reporting is applicable to current operations.

Cultivation-Related Wastes:

Project Compliance Y /N

Cultivation-related wastes are improperly stored at Site 08. Cultivation-related wastes, including, but not limited to, empty soil/soil amendment/ fertilizer/pesticide bags and containers, empty plant pots or containers, dead or harvested plant waste, and spent growth medium, shall be stored in locations where they cannot enter or be blown into surface waters, or in a manner that will not result in residues and pollutants within such materials to migrate or leach into surface water or groundwaters.

Organic cultivation-related wastes are collected from the cultivation areas and either disposed of properly with general waste or composted. The cannabis cultivator shall ensure that the locations where organic wastes are stored or composted are minimized in number and are sited outside of watercourse riparian areas and away from any form of surface runoff.

Non-organic cultivation-related wastes are stored in lidded trashcans and garbage bags adjacent to or in the residence, sheds, and cultivation areas and are disposed of regularly at a solid waste transfer station. The cannabis cultivator shall continue to gather and properly dispose of cultivation-related wastes and ensure that wastes are adequately contained from scavenging wildlife, and cannot be transported away from storage areas by wind or surface runoff.



Refuse and Domestic Waste:Project Compliance Y /N 

Garbage and refuse are stored on the property within lidded trash cans and garbage bags and are disposed of regularly at the nearest solid waste transfer station. The cannabis cultivator shall continue to gather and properly dispose of refuse and ensure that refuse is adequately contained from scavenging wildlife, and cannot be transported away from storage areas by wind or surface runoff.

Human waste is managed by a septic system on site. It is the cannabis cultivator's responsibility to ensure compliance of such action with the Humboldt County Department of Environmental Health and Human Services.

Annual Winterization Measures

Winterization measures consist of general cleanup and winter-preparation activities that both prepare for and utilize, anticipated, local winter weather. In project areas that may become inaccessible during periods, or the entirety, of the winter, additional winterization procedures and precautions may be required due to the potential absence of winter monitoring.

- Any exposed soils resulting from winterization activities shall be seeded and straw mulched.
- Any/all areas of exposed soils in and around cultivation areas are seeded and either straw mulched with weed free straw or woodchips.
- All existing culvert inlets, interiors, and outlets shall be cleared of any existing or potential obstructions to include; debris upstream of the culvert such as sediment, loose, moveable rocks, and raftable, small, woody debris.
- Damage or wear resulting from vehicular use to road surfaces (such as rutting or wheel tracks) and/or road surfacing (such as rock) that would impair road surface drainage or drainage features (such as outsloping, waterbars, rolling dips, etc.) shall be repaired prior to the Winter Period.
- All existing surface drainage features and sediment capture features shall be maintained if needed to ensure continued function through the Winter Period.
- All fertilizers and petroleum products will be stored in an area located outside of riparian setbacks, completely sealed, placed in a secondary containment (liquids), and stored in a manner that prevents contact with precipitation and surface runoff.
- Water storage tank lids shall be appropriately closed to prevent the access of wildlife.
- All refuse/trash shall be removed and disposed of appropriately.
- All inorganic material capable of being transported by wind or rain shall be secured and stored appropriately.



**STATEMENT OF CONTINGENT AND LIMITING CONDITIONS CONCERNING  
THE PREPARATION AND USE OF REPORTS ADDRESSING GENERAL  
WASTE DISCHARGE REQUIREMENTS UNDER ORDER WQ 2019-0001-DWQ**

**Prepared by Timberland Resource Consultants**

1. This document has been prepared for the property within APN 218-031-008, in Humboldt County, for enrollment in the General Waste Discharge Order WQ 2019-0001-DWQ.
2. Timberland Resource Consultants does not assume any liability for the use or misuse of the information in this document.
3. The information is based upon conditions apparent to Timberland Resource Consultants at the time inspection(s) were conducted. Changes due to land use activities or environmental factors occurring after inspection have not been considered in this document.
4. Maps, photos, and any other graphical information presented in this report are for illustrative purposes. Their scales are approximate, and they are not to be used for locating and establishing boundary lines.
5. The conditions presented in this document may differ from those made by others or from changes on the property occurring after inspections were conducted. Timberland Resource Consultants does not guarantee this work against such differences.
6. Timberland Resource Consultants did not conduct an investigation on a legal survey of the property.
7. Persons using this document are advised to contact Timberland Resource Consultants prior to such use.
8. Timberland Resource Consultants will not discuss this document or reproduce it for anyone other than the Client for which this document was prepared without authorization from the Client.



Anna Urias

**Timberland Resource Consultants**



# Site Management Plan

## Project Site Map



Order WQ 2019-0001-DWQ [WDID - 1\_12CC419436]  
Section 11, T5S, R5E, Humboldt County,  
Jewett Rock 7.5' USGS Quadrangle  
TRC-461

- Property Boundary
- Disturbed Area
- Cultivation Area
- Structure

### Map Legend

- Pond
- Roads**
  - County
  - Permanent
  - Seasonal
  - Legacy

- Watercourses**
  - Class II
  - Class III
  - Class IV
- Site
- Well
- Tank
- POD
- Bladder
- Spring

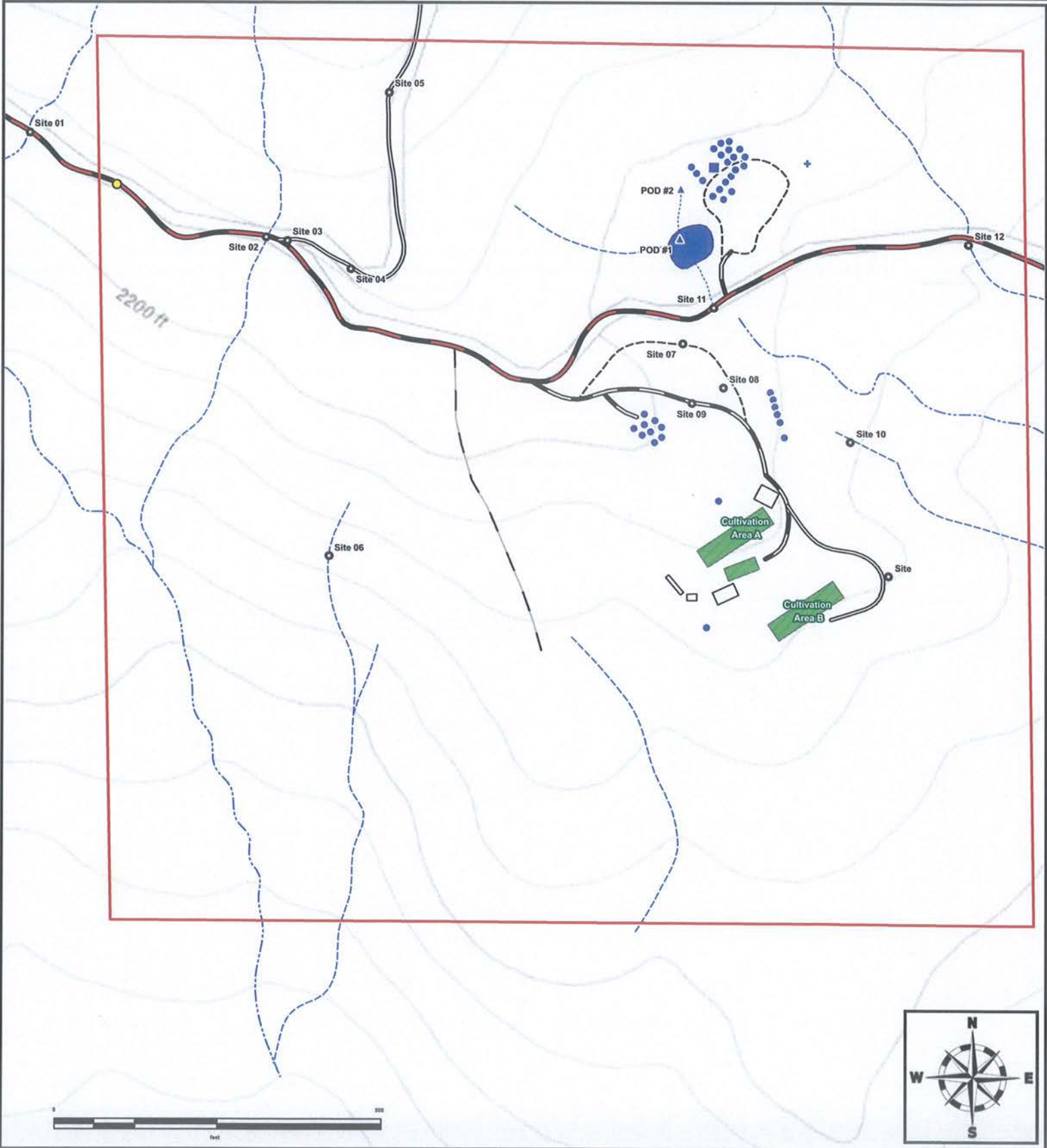



# Site Management Plan

## Project Site Map



Order WQ 2019-0001-DWQ [WDID - 1\_12CC419436]  
Section 11, T5S, R5E, Humboldt County,  
Jewett Rock 7.5' USGS Quadrangle  
TRC-461

- Property Boundary
- Disturbed Area
- Cultivation Area
- Structure

### Map Legend

- Pond

- County
- Permanent
- Seasonal
- Legacy

### Watercourses

- Class II
- Class III
- Class IV

- Site
- Well
- Tank
- POD
- Bladder
- Spring







# Treatment Implementation Schedule

Unique Point	Proposed Work Completion Date
<b>Immediately</b>	
Site 07	Immediately
Site 08	Immediately
Site 13	Immediately
POD #1	Immediately
POD #2	Immediately
Past Cultivation Areas	Immediately
Water Storage and Use	Immediately
Liquid Petroleum Products	Immediately
Generators and Gas Powered Pumps	Immediately
<b>Prior to 10/15/21</b>	
Site 04	Prior to 10/15/21
Site 06	Prior to 10/15/21
Site 10	Prior to 10/15/21
<b>As required by the amended LSAA/1600</b>	
Site 11	As required by the amended LSAA/1600
Site 12	As required by the amended LSAA/1600





# SMP - Mitigation Report

WDID# - 1\_12CC419436

Unique Point	Lat-Long NAD 83	Road Type	Mitigation Planned	Monitor	1600	Treatment Priority	Date Completed
Site 01	-123.58129 40.046332	County Road	-	-	-	-	
Current Condition: Existing 18" diameter culvert on a Class II watercourse. The culvert is shown on the Site Map to display that it is off the property.						Prescribed Action: None.	
Unique Point	Lat-Long NAD 83	Road Type	Mitigation Planned	Monitor	1600	Treatment Priority	Date Completed
Site 02	-123.580003 40.045896	County Road	-	X	-	-	
Current Condition: Existing culvert crossing on a Class III watercourse. The dimensions are unknown due to vegetation obstructing the outlet and inlet. Island Mountain Road is a County owned road and therefore the maintenance of the crossing is not the Cultivator's responsibility.						Prescribed Action: None.	
Unique Point	Lat-Long NAD 83	Road Type	Mitigation Planned	Monitor	1600	Treatment Priority	Date Completed
Site 03	-123.579884 40.045881	Seasonal	X	X	-	-	
Current Condition: Existing 16" ditch relief culvert functioning adequately that drains under the seasonal road and into the inboard ditch line of Island Mountain Road.						Prescribed Action: None.	
Unique Point	Lat-Long NAD 83	Road Type	Mitigation Planned	Monitor	1600	Treatment Priority	Date Completed
Site 04	-123.579539 40.045763	Seasonal	X	X	-	Prior to 10/15/21	
Current Condition: The seasonal road lacks adequate spacing of surface drainage structures.						Prescribed Action: A Type 1 rolling dip shall be installed to the specifications in the attached BMP: Rolling Dip Design and Placement.	
Unique Point	Lat-Long NAD 83	Road Type	Mitigation Planned	Monitor	1600	Treatment Priority	Date Completed
Site 05	-123.579331 40.046501	Seasonal	-	X	-	-	
Current Condition: Existing 16" ditch relief culvert that is functioning adequately.						Prescribed Action: None.	
Unique Point	Lat-Long NAD 83	Road Type	Mitigation Planned	Monitor	1600	Treatment Priority	Date Completed
Site 06	-123.579654 40.04456	-	X	X	-	Prior to 10/15/21	
Current Condition: Historical POD infrastructure located in a Class III watercourse. The historical diversion infrastructure can be removed without any alteration to the bed, bank, or channel.						Prescribed Action: The Cultivator shall remove the historical POD infrastructure from the watercourse immediately.	



# SMP - Mitigation Report

WDID# - 1\_12CC419436

Unique Point	Lat-Long NAD 83	Road Type	Mitigation Planned	Monitor	1600	Treatment Priority	Date Completed
Site 07	-123.577722 40.045452	Trail	X	X	-	Immediately	
Current Condition: Exposed pile of used potting soil and cultivation-related materials located in a riparian zone.						Prescribed Action: The exposed potting soil and cultivation-related wastes shall be removed and stored away from the riparian zone in a manner where they cannot be transferred into a watercourse.	
Unique Point	Lat-Long NAD 83	Road Type	Mitigation Planned	Monitor	1600	Treatment Priority	Date Completed
Site 08	-123.5775 40.045268	-	X	X	-	Immediately	
Current Condition: Improper storage of cultivation-related wastes.						Prescribed Action: Cultivation-related wastes shall be removed and stored in an manner where they cannot be transferred into a watercourse.	
Unique Point	Lat-Long NAD 83	Road Type	Mitigation Planned	Monitor	1600	Treatment Priority	Date Completed
Site 09	-123.577671 40.045202	Trail	-	X	-	-	
Current Condition: Existing 18" ditch relief culvert that is functioning adequately.						Prescribed Action: None.	
Unique Point	Lat-Long NAD 83	Road Type	Mitigation Planned	Monitor	1600	Treatment Priority	Date Completed
Site 10	-123.576806 40.045042	Trail	-	X	-	Prior to 10/15/21	
Current Condition: Minor scarping occurring above the head of a Class III watercourse that drains into an off property, on stream-pond. The erosion is not being exacerbated by any activities above and the surrounding areas are well vegetated and stable.						Prescribed Action: No mitigation is required at this time however, the site shall be monitored for any increased erosion or surface cracking. If additional erosion is identified, erosion control and sediment detention devices shall be installed. See attached BMP for specifications: General Erosion Control.	
Unique Point	Lat-Long NAD 83	Road Type	Mitigation Planned	Monitor	1600	Treatment Priority	Date Completed
Site 11	-123.577553 40.045602	County Road	X	X	X	As required by the amended LSAA/1600	
Current Condition: Existing 12" diameter culvert on a Class III watercourse on Island Mountain Road, a County road.						Prescribed Action: The existing Lake or Streambed Alteration Agreement (LSAA/1600) signed by the previous landowner requires that the crossing be upgraded to a 30" diameter culvert. However, Island Mountain Road is a County road and therefore Cultivator is not responsible for the culvert upgrade or maintenance. The LSAA/1600 requires a minor amendment to be transferred into the current Cultivator's name.	





# SMP - Mitigation Report

WDID# - 1\_12CC419436

Unique Point	Lat-Long NAD 83	Road Type	Mitigation Planned	Monitor	1600	Treatment Priority	Date Completed
Site 12	-123.576159 40.045872	County Road	X	X	X	As required by the amended LSAA/1600	
Current Condition: Existing 15" diameter culvert on a Class III watercourse on Island Mountain Road, a County road.						Prescribed Action: The existing Lake or Streambed Alteration Agreement (LSAA/1600) signed by the previous landowner requires that the crossing be upgraded to a 36" diameter culvert. However, Island Mountain Road is a County road and therefore the Cultivator is not responsible for the culvert upgrade or maintenance. The LSAA/1600 requires a minor amendment to be transferred into the current Cultivator's name.	
Unique Point	Lat-Long NAD 83	Road Type	Mitigation Planned	Monitor	1600	Treatment Priority	Date Completed
Site 13	-123.576597 40.044479	-	X	X	-	Immediately	
Current Condition: Improper storage of cultivation-related wastes.						Prescribed Action: Cultivation-related wastes shall be removed and stored in a manner where they cannot be transferred into a watercourse.	
Unique Point	Lat-Long NAD 83	Road Type	Mitigation Planned	Monitor	1600	Treatment Priority	Date Completed
POD #2	-123.577738 40.045889	-	X	X	-	Immediately	
Current Condition: Spatial reference to POD #2 located in a unnamed spring that feeds into to the pond. The POD is used for domestic use and cannabis irrigation and lacks a meter.						Prescribed Action: The Cultivator shall install a metering device and/or a procedure to monitor water usage to record all water used for the irrigation of cannabis and domestic use.	
Unique Point	Lat-Long NAD 83	Road Type	Mitigation Planned	Monitor	1600	Treatment Priority	Date Completed
Bladder	-123.577552 40.04619	Trail	X	X	-	Prior to 10/15/21	
Current Condition: Spatial reference to an empty water bladder.						Prescribed Action: The Cultivator shall decommission the water bladder or Per Cannabis Cultivation Policy: Attachment A, Section 2, No. 88 & 89 for cannabis cultivators, bladders shall be safely contained within a secondary containment system with sufficient capacity to capture 110 percent of a bladders maximum volume in the event of bladder failure and if open to rainfall, and/or (whichever is larger) capable to accommodate precipitation and storm water inputs from 24 hours of a 25-year storm event. Secondary containment is recommended in the form of a dirt berm, containment pit, combination of both, or impermeable material with skeletal support.	
Unique Point	Lat-Long NAD 83	Road Type	Mitigation Planned	Monitor	1600	Treatment Priority	Date Completed
Well	-123.577042 40.046207	Trail	-	X	-	-	
Current Condition: Spatial reference to a groundwater well.						Prescribed Action: None.	



# SMP - Mitigation Report

WDID# - 1\_12CC419436

Unique Point	Lat-Long NAD 83	Road Type	Mitigation Planned	Monitor	1600	Treatment Priority	Date Completed
POD #1	-123.577731 40.046096	Trail	X	X	-	Immediately	
Current Condition: Spatial reference to POD #1 located in the pond. The POD is used for domestic use and cannabis irrigation and lacks a meter.						Prescribed Action: The Cultivator shall install a metering device and/or a procedure to monitor water usage to record all water used for the irrigation of cannabis and domestic use.	
Unique Point	Lat-Long NAD 83	Road Type	Mitigation Planned	Monitor	1600	Treatment Priority	Date Completed
Spring	-123.580818 40.046114	County Road	-	X	-	-	
Current Condition: Spatial reference to a cutbank spring on the inboard side of Island Mountain Road. The Cultivator does not use this water source.						Prescribed Action: None.	
Unique Point	Lat-Long NAD 83	Road Type	Mitigation Planned	Monitor	1600	Treatment Priority	Date Completed
Tank bank #1	-123.577932 40.045113	-	-	X	-	-	
Current Condition: Spatial reference to Tank Bank # 1 containing two 2,500-gallon tanks, two 3,000-gallon tanks, four 4,000-gallon tanks, and nine 5,000-gallon tanks.						Prescribed Action: None.	
Unique Point	Lat-Long NAD 83	Road Type	Mitigation Planned	Monitor	1600	Treatment Priority	Date Completed
Tank bank #2	-123.577167 40.045058	Seasonal	X	X	-	-	
Current Condition: Spatial reference to Tank Bank #2 containing six 3,000-gallon tanks.						Prescribed Action: None.	
Unique Point	Lat-Long NAD 83	Road Type	Mitigation Planned	Monitor	1600	Treatment Priority	Date Completed
Tank bank #3	-123.577457 40.046154	-	-	X	-	-	
Current Condition: Spatial reference to Tank Bank #3 containing one 3,000-gallon tank, four 4,000-gallon tanks, and twelve 5,000-gallon tanks.						Prescribed Action: None.	
Unique Point	Lat-Long NAD 83	Road Type	Mitigation Planned	Monitor	1600	Treatment Priority	Date Completed
Past Cultivation Areas	-	-	X	X	-	Immediately	
Current Condition: Past cultivation areas that are no longer used with remaining cultivation-related materials, fencing, wastes, and soils.						Prescribed Action: Remove any remaining fencing, pots, or other cultivation-related wastes and materials from these areas. Seed and mulch the Past Cultivation Area, and any Disturbed Area associated with its removal, with native grass seed and weed free straw(or woodchips). If cultivation soil is not re-used, contour the cultivation-related soils into the ground outside of any riparian buffer areas, and seed and mulch the contoured soils with native grass seed and weed free straw.	





# SMP - Mitigation Report

WDID# - 1\_12CC419436

Unique Point	Lat-Long NAD 83	Road Type	Mitigation Planned	Monitor	1600	Treatment Priority	Date Completed
Water Storage and Use	-	-	X	X	-	Immediately	
<p><b>Current Condition:</b> Currently there is enough water storage on the property to meet forbearance requirements during the required period from April 1st to October 31st. At present there are no devices or procedures in place to record water usage associated with the irrigation of cannabis and domestic use.</p>						<p><b>Prescribed Action:</b> Recorded water use data shall be used to determine remaining, or exact, storage needs to meet full forbearance. Any additional storage needed to meet water needs during the Forbearance Period shall be installed and filled prior to the Forbearance Period for 2021. Less water storage may be sufficient if recorded water usage numbers determine that actual water use is less than estimates. Water metering devices, or procedures for the wells, shall be installed to record all water diverted, pumped, and used water for the irrigation of cannabis and domestic use. Water meter(s) and water supply infrastructure shall be designed/installed in a manner such that water usage for the irrigation of cannabis can be recorded separately from water used for domestic use. Additionally, if there are multiple sources of water, infrastructure/metering device(s) shall be design/installed in a manner that each source of water is recorded separately. Monthly water usage shall be recorded for annual reporting purposes. Also, water storage tank lids shall be appropriately closed to prevent the access of wildlife and, if not currently implemented, water conservation measures such as drip line irrigation, morning or evening watering, and mulch or cover cropping of cultivated top soils shall also be implemented.</p>	
Unique Point	Lat-Long NAD 83	Road Type	Mitigation Planned	Monitor	1600	Treatment Priority	Date Completed
Liquid Petroleum Products	-	-	X	X	-	Immediately	
<p><b>Current Condition:</b> All liquid petroleum products (e.g. any size container of any petroleum product) requires secondary containment while not in immediate use and cover from precipitation during the wet season. Adequate quantities of absorbent materials shall also be stored at all locations where these types of materials are used and stored.</p>						<p><b>Prescribed Action:</b> Any/all liquid petroleum products and their containers shall be stored in secondary containment (e.g. plastic totes or sealed metal boxes) while being stored long term or not in immediate use, wherever these materials are used anywhere on the property. Adequate quantities of absorbent materials (e.g. purpose made materials for oil and fuel spills, cat litter) shall be stored at all locations where these types of materials are used and stored. Should a spill of these materials occur, absorbent materials will be applied immediately and allowed enough time to absorb as much material as possible. Following treatment, absorbent materials applied as well as any contaminated soil will be removed and disposed of appropriately for the spilled material. See attached BMPs: Generator, Fuel, and Oil Management for further details.</p>	



# SMP - Mitigation Report

WDID# - 1\_12CC419436

Unique Point	Lat-Long NAD 83	Road Type	Mitigation Planned	Monitor	1600	Treatment Priority	Date Completed
Generators and Gas Powered Pumps	-	-	X	X	-	Immediately	
<p><b>Current Condition:</b> All liquid petroleum powered generators and pumps require secondary containment, and cover from precipitation during the wet season. Adequate quantities of absorbent materials shall also be stored at all locations where the generators and gas powered pumps are used and stored.</p>						<p><b>Prescribed Action:</b> Any/all liquid petroleum powered generators or pumps (large or small) shall be stored in secondary containment (e.g. plastic totes, sealed metal boxes, drip pans, pre-fabricated portable containment berms or fabricated and lined containment basins) while being stored long term or not in immediate use, wherever these materials are used anywhere on the property. Adequate quantities of absorbent materials shall be stored at all locations where these types of materials are used and stored. Should a spill of these materials occur, absorbent materials will be applied immediately and allowed enough time to absorb as much material as possible. Following treatment, absorbent materials applied as well as any contaminated soil will be removed and disposed of appropriately for the spilled material. See attached BMPs: Generator, Fuel, and Oil Management for further details.</p>	



## **BMP: Generator, Fuel, and Oil Management**

All bulk fuel storage or petroleum products, any/all future petroleum products and other liquid chemicals, including but not limited to diesel, biodiesel, gasoline, and oils shall be stored so as to prevent their spillage, discharge, or seepage into receiving waters. Storage tanks and containers shall be of suitable material and construction to be compatible with the substance(s) stored and conditions of storage such as pressure and temperature. Above ground storage tanks and containers shall be provided with a secondary means of containment for the entire capacity of the largest single container and sufficient cover shall be provided to prevent any/all precipitation from entering said secondary containment vessel.

If the volume of a fuel container is greater than 1,320 gallons, a Spill Prevention, Control, and Countermeasures (SPCC) plan will be required for the use the fuel tank.

On-site storage of petroleum products, or other fuels used for commercial activities may require registration as hazardous materials through the California Environmental Reporting System (CERS). Additionally, the waste oil generated from commercial activities (generators) and their used oil filters are considered hazardous waste and requires additional reporting. The discharger is advised to contact local agencies to find out if such reporting is applicable to currently operations

Used motor oil is recommended to be stored in sealed containers that the oil was originally packaged in, e.g. sealed buckets/quart or gallon jugs, or other sealed containers designed to store motor oil. Stored used oil is recommended to be regularly disposed of at hazardous waste disposal sites. Used oil filters are also recommended to be stored in sealed containers, e.g. sealed plastic totes/buckets, for later disposal at a hazardous waste disposal site. These storage containers are recommended to be stored in structures where they are protected from precipitation.

Further information regarding the State of California's requirements for the managing of Used Oil and Oil Filters can be found by entering the links below or searching the corresponding titles to the links.

### **California Department of Toxic Substances Control - Used Oil Generator Requirements**

- <https://www.dtsc.ca.gov/InformationResources/upload/RAG-UsedOilforGenerators.pdf>

### **Department of Toxic Substances Control - Managing Used Oil Filters for Generator**

- [https://www.dtsc.ca.gov/InformationResources/upload/RAG\\_Used-Oil-Filters\\_Generators1.pdf](https://www.dtsc.ca.gov/InformationResources/upload/RAG_Used-Oil-Filters_Generators1.pdf)

## **BMP: Generator, Fuel, and Oil Management (Generators and Pumps)**

All generators and petroleum powered pumps shall have spill trays or secondary containment placed underneath them when using, fueling, or changing oil on them to prevent the potential for leeching, seepage or spillage of petroleum products. All spill trays and containment structures require cover from precipitation if used or left out over the winter period. All generators and petroleum powered pump locations shall have spill cleanup kits on hand.

Pre-fabricated secondary containment structures and spill trays can be purchased online or from local wholesalers of petroleum products. As an alternative to pre-fabricated secondary containment structures, structures can be constructed from wooden, cinderblock, concrete, or metal frames lined with PVC liners, e.g. pond liner/water bladder material, as long as the containment is fully sealed and constructed in a similar manner to examples of pre-fabricated containment structures found below. Ensure that diked areas are sufficiently impervious to contain discharged chemicals. All containment structures require cover from precipitation to prevent the containment from filling with water. Secondary containment for fuel tanks shall not be constructed.

As an alternative to pre-fabricated spill kits, kits can consist of sealed trashcans or buckets with industrial absorbent material (e.g. cat litter) and shovels, placed nearby any location where generators, pumps, or other petroleum products or chemicals are used.

Examples of industry standard pre-fabricated spill containment and clean-up kits can be found following or entering the links below. Pre-fabricated spill containment and clean-up kits can be purchased online, from Renner Petroleum, or other similar industry providers.

### **Ultratech Spill Containment**

- <http://www.spillcontainment.com/categories/spill-containment/>

### **New Pig Portable and Collapsible Spill Containment**

- <https://www.newpig.com/collapsible-berms/c/5142?show=All>



## BMP: Generator, Fuel, and Oil Management



Example of a small, portable, and compact containment berm.



Example of a portable utility spill tray.

**BMP: Generator, Fuel, and Oil Management**



**Example of secondary containment for a fuel tank. This container requires cover from precipitation.**



**Example of spill pallets for unused or used oil drums and other petroleum products.**



## **BMP: Winterization and Interim Treatments for Erosion Control**

- **Roads**
  - Existing or newly installed road surface drainage structures such as water bars, rolling dips, ditch relief culverts, and intentionally in/out-sloped segments of road shall be maintained to ensure continued function of capturing and draining surface runoff.
  - Hand tool kick-outs (lead out ditch) for existing wheel rut, surface run-off confinement.
  - Temporary waterbar/cross-wattles installed on road/trail sections of concentrating surface runoff.
  - Clean existing ditch relief culvert inlets, outlets, and contributing ditch lines of current and potential blockage debris by hand.
  - Hand place energy dissipating rock/small woody debris at ditch relief culvert outlets where erosion is occurring.
  - Wattles/straw bales placed at road runoff delivery sites.
  - Touch-up with hand tools of existing surface drainage structures (kick-outs, rolling dips, and waterbars).
  - Seed and straw un-used, or to be abandoned, road surfaces where erosion is occurring.
  - Frequent use of un-surfaced roads should be avoided, particularly when road surfaces are soft/saturated.
  
- **Crossings**
  - Clean inlets, outlets, and channels above of current and potential blockage debris by hand.
  - Hand place energy dissipating rock/small woody debris at ditch relief culvert outlets.
  - Hand placement of rock armor around culvert inlets.
  - Install staked wattles along the outboard road edge of out-sloped watercourse crossings where direct delivery of road surface runoff is occurring.
  - Hand placement of rock on crossing fill faces where erosion is/may occur as a result of poor crossing construction.
  
- **Cultivation Areas**
  - Use hand tools to capture cultivation related soils that are not contained (soil from post-harvest plant removal, soil/planter removal, general spillage).
  - Treat beds, pots, new soil storage piles, spent soil piles, and soil disposal piles with cover crops for soil stability and potentially nitrogen fixing/soil amendment.
  - Bagged potting soil should be covered.
  - Install staked wattles or an earthen berm around cultivation soils piles prior to the winter period, annually.
  - Any soil amendment, fertilizer, herbicide, or pesticide that is not 100% sealed should be stored under cover.
  - Cultivation sites with poor or concentrating drainage can have wattles or bales installed prior to winter to help prevent sediment and nutrients from leaving the site.
  - Plastic netting shall be disposed of or stored where it is inaccessible to wildlife.
  - Tarps/dep covers shall be stored so they cannot be blown away.
  - General waste from growing season gathered up and disposed of.
  - Exposed soil surfaces in the cultivation area, as well as graded fill slopes should be seeded, strawed, mulched, jute netted as needed.
  
- **General Areas**
  - Remove all refuse prior to leaving property for the season.
  - Back fill pit toilets to be abandoned.

## **BMP: General Recommendations**

- **Fertilizers, soil amendments, and pesticides**
  - Fertilizer, soil amendments, and pesticide use it to be recorded in such a manner that cumulative annual totals are recorded for annual reporting.
  - Store in-use fertilizers in a securable storage container, such as a tote or deck box, adjacent to the mixing tanks.
  
- **Petroleum products and hazardous materials**
  - Utilize spill trays/containment structures and cover over the containment when using, fueling, changing oil on portable generators or petroleum powered water pumps to prevent the potential for leeching, seepage or spillage of petroleum products.
  - It is recommended that all petroleum products and other chemicals are registered with the California Environmental Reporting System (CERS) to satisfy future licensing requirements.
  
- **Water storage and Use**
  - Water use shall be designed and metered such that water used for the irrigation of cannabis will be recorded separately from domestic use. Water use for the irrigation of cannabis is to be recorded monthly for annual reporting.
  - Ensure lids are secured on all water storage tanks to prevent wildlife from becoming entrapped within the tank.
  - Install float valves, or implement another equivalent system, on all applicable water storage and transfer tanks to prevent unnecessary water diversion and the overflowing of water tanks.



## **BMP: General Operations BMPs**

- If operations require moving of equipment across a flowing stream, such operations shall be conducted without causing a prolonged visible increase in stream turbidity. For repeated crossings, the operator shall install a bridge, culvert, or rock-lined crossing.
- During construction in flowing water, which can transport sediment downstream, the flow shall be diverted around the work area by pipe, pumping, temporary diversion channel or other suitable means. When any dam or artificial obstruction is being constructed, maintained, or placed in operation, sufficient water shall at all times be allowed to pass downstream to maintain fish life below the dam. Equipment may be operated in the channel of flowing live streams only as necessary to construct the described construction.
- Disturbance or removal of vegetation shall not exceed the minimum necessary to complete operations. The disturbed portion of any stream channel shall be restored to as near their original condition as possible. Restoration shall include the mulching of stripped or exposed dirt areas at crossing sites prior to the end of the work period.
- Structures and associated materials not designed to withstand high seasonal flow shall be removed to areas above the high-water mark before such flows occur.
- No debris, soil, silt, sand, bark, slash, sawdust, rubbish, cement or concrete washing, oil or petroleum products, or other organic or earthen material from any logging, construction, or associated activity of whatever nature shall be allowed to enter into or be placed where it may be washed by rainfall or runoff into waters of the State. When operations are completed, any excess materials or debris shall be removed from the work area. No rubbish shall be deposited within 150 feet of the high-water mark of any stream.

## **BMP: General Erosion Control**

- Timing for soil stabilization measures within the 100 feet of a watercourse or lake: For areas disturbed from May 1 through October 15, treatment shall be completed prior to the start of any rain that causes overland flow across or along the disturbed surface. For areas disturbed from October 16 through April 30, treatment shall be completed prior to any day for which a chance of rain of 30 percent or greater is forecast by the National Weather Service or within 10 days, whichever is earlier.
- Within 100 feet of a watercourse or lake, the traveled surface of logging roads shall be treated to prevent waterborne transport of sediment and concentration of runoff that results from operations. Treatment may consist of, but not limited to, rocking, out sloping, rolling dips, cross drains, water bars, slope stabilization measures, or other practices appropriate to site-specific conditions.
- The treatment for other disturbed areas within 100 feet of a watercourse or lake, including: (A) areas exceeding 100 contiguous square feet where operations have exposed bare soil, (B) approaches to road watercourse crossings out to 100 feet or the nearest drainage facility, whichever is farthest, (C) road cut banks and fills, and (D) any other area of disturbed soil that threatens to discharge sediment into waters in amounts deleterious to the quality and beneficial uses of water, shall be grass seeded and mulched with straw or fine slash. Grass seed shall be applied at a rate exceeding 100 pounds per acre. Straw mulch shall be applied in amounts sufficient to provide at least 2- 4-inch depth of straw with minimum 90% coverage. Slash may be substituted for straw mulch provided the depth, texture, and ground contact are equivalent to at least 2 – 4 inches of straw mulch. Any treated area that has been subject to reuse or has less than 90% surface cover shall be treated again prior to the end of operations.
- Within 100 feet of a watercourse or lake, where the undisturbed natural ground cover cannot effectively protect beneficial uses of water from operations, the ground shall be treated with slope stabilization measures described in #3 above per timing described in #1 above.
- Side cast or fill material extending more than 20 feet in slope distance from the outside edge of a landing which has access to a watercourse or lake shall be treated with slope stabilization measures described in #3 above. Timing shall occur per #1 above unless outside 100 feet of a watercourse or lake, in which completion date is October 15.
- All roads shall have drainage and/or drainage collection and storage facilities installed as soon as practical following operations and prior to either (1) the start of any rain which causes overland flow across or along the disturbed surface within 100 feet of a watercourse or lake protection, or (2) any day with a National Weather Service forecast of a chance of rain of 30 percent or more, a flash flood warning, or a flash flood watch.



**BMP: General Erosion Control (Cont.)**

- Erosion control and sediment detention devices and materials shall be incorporated into the cleanup/restoration work design and installed prior to the end of project work and before the beginning of the rainy season. Any continuing, approved project work conducted after October 15 shall have erosion control works completed up-to-date and daily.
- Erosion control materials shall be, at minimum, stored on-site at all times during approved project work between May 1 and October 15.
- Approved project work within the 5-year flood plain shall not begin until all temporary erosion controls (straw bales or silt fences that are effectively keyed-in) are installed downslope of cleanup/restoration activities.
- Non-invasive, non-persistent grass species (e.g., barley grass) may be used for their temporary erosion control benefits to stabilize disturbed slopes and prevent exposure of disturbed soils to rainfall.
- Upon work completion, all exposed soil present in and around the cleanup/restoration sites shall be stabilized within 7 days.
- Soils exposed by cleanup/restoration operations shall be seeded and mulched to prevent sediment runoff and transport.
- Straw Wattles (if used) shall be installed with 18 or 24-inch wood stakes at four feet on center. The ends of adjacent straw wattles shall be abutted to each other snugly or overlapped by six inches. Wattles shall be installed so that the wattle is in firm contact with the ground surface.

**BMP: General Erosion Control (Cont.)**

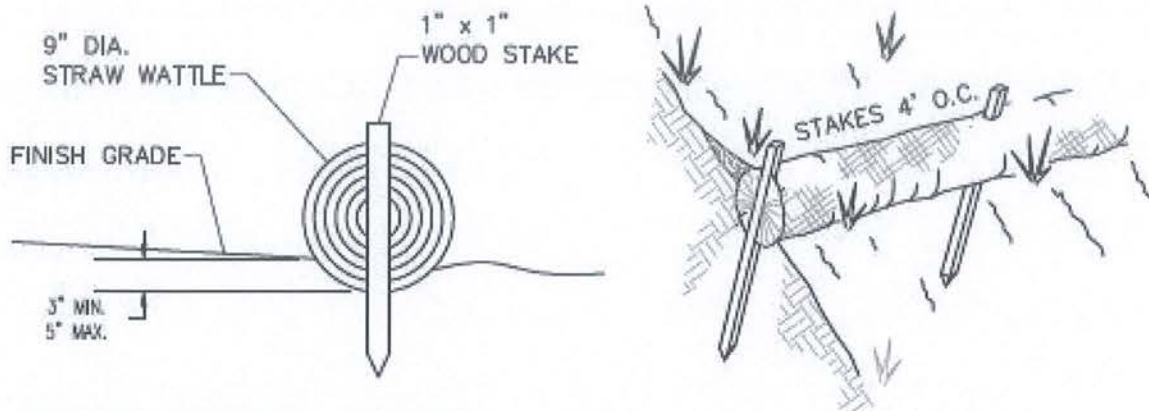

**STRAW WATTLE NOTES:**

1. STRAW WATTLES SHALL BE INSTALLED WITH 18 OR 24 INCH WOOD STAKES AT FOUR FEET ON CENTER. THE ENDS OF ADJACENT STRAW WATTLES SHALL BE ABUTTED TO EACH OTHER SNUGLY OR OVERLAPPED BY SIX INCHES.
2. STRAW ROLL INSTALLATION REQUIRES THE PLACEMENT AND SECURE STAKING OF THE ROLL IN A TRENCH, 3"-5" DEEP. RUNOFF MUST NOT BE ALLOWED TO RUN UNDER OR AROUND THE ROLL.

**STRAW WATTLE INSTALLATION DETAIL**

NTS

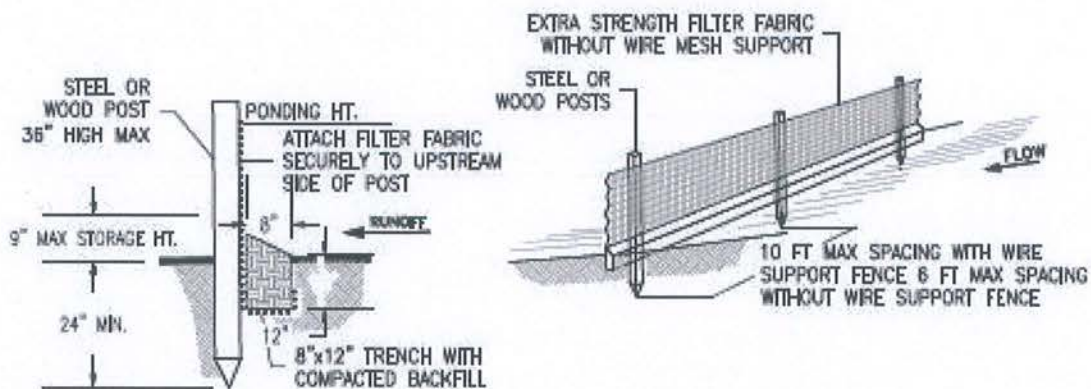

**SILT FENCE NOTES:**

1. THE CONTRACTOR SHALL INSPECT AND REPAIR FENCE AFTER EACH STORM EVENT.
2. CONTRACTOR SHALL REMOVE SEDIMENT AS NECESSARY. REMOVED SEDIMENT SHALL BE DEPOSITED TO AN AREA THAT WILL NOT CONTRIBUTE SEDIMENT OFF-SITE AND IN AN AREA THAT CAN BE PERMANENTLY STABILIZED.
3. SILT FENCE SHALL BE PLACED ON SLOPE CONTOURS TO MAXIMIZE PONDING EFFICIENCY.

**SILT FENCE DETAILS**

NTS



**BMP: General Erosion Control (Cont.)**



## BMP: General Erosion Control (Cont.)

### SPREAD THE STRAW

MARK OFF 800 SQ FT. PLOTS

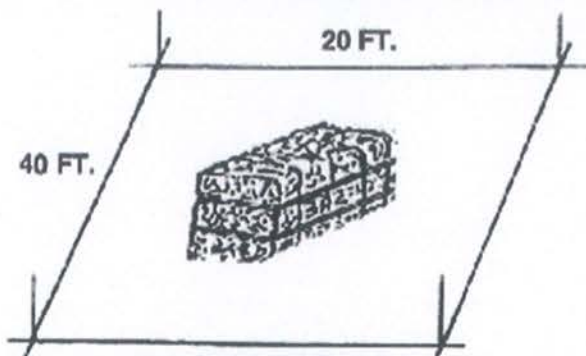

PLACE ONE STRAW BALE PER PLOT (~74 POUNDS). THIS IS EQUIVALENT TO 2 TONS PER ACRE.

SPREAD EVENLY

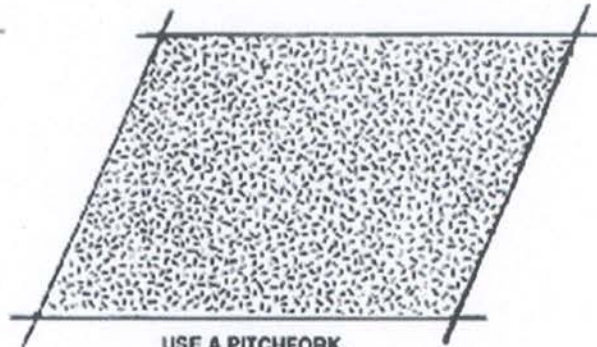

USE A PITCHFORK, SPADING FORK, OR BY HAND

### ANCHOR THE STRAW

CRIMP BY HAND

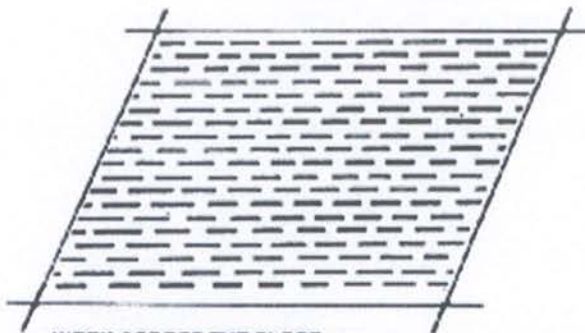

WORK ACROSS THE SLOPE. PUNCH STRAW 4 INCHES DEEP. A SQUARE END SPADE WORKS WELL. MAKE PUNCH EVERY 12 INCHES.

OR

USE PLASTIC NETTING

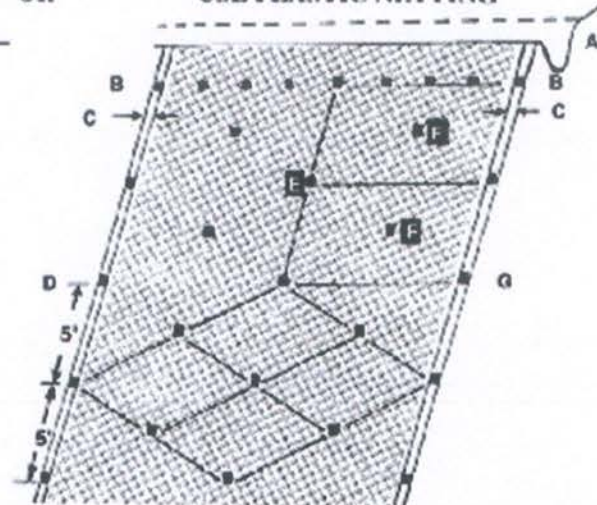

**A.** LAY BIRD CONTROL NETTING OR SIMILAR MATTING IN STRIPS DOWN THE SLOPE OVER THE STRAW. BURY UPPER END IN 6-8 INCH DEEP AND WIDE TRENCH.. MOST NETTING COMES IN 14 TO 17 FT. WIDE ROLLS.

**B.** SECURE THE UPPER END WITH STAKES EVERY 2 FEET.

**C.** OVERLAP SEAMS ON EACH SIDE 4-5 INCHES.

**D.** SECURE SEAMS WITH STAKES EVERY 5 FEET.

**E.** STAKE DOWN THE CENTER EVERY 5 FEET.

**F.** STAKE MIDDLES TO CREATE DIAMOND PATTERN THAT PROVIDES STAKES SPACED 4-5 FEET APART.

**G.** USE POINTED 1X2 INCH STAKES 8 TO 9 INCHES LONG. LEAVE 1 TO 2 INCH TOP ABOVE NETTING, OR USE "U" SHAPED METAL PINS AT LEAST 9 INCHES LONG.

**NOTE:** WHEN JOINING TWO STRIPS, OVERLAP UPPER STRIP 3 FEET OVER LOWER STRIP AND SECURE WITH STAKES EVERY 2 FEET LIKE IN "B" ABOVE



**BMP: General Erosion Control (Cont.)**

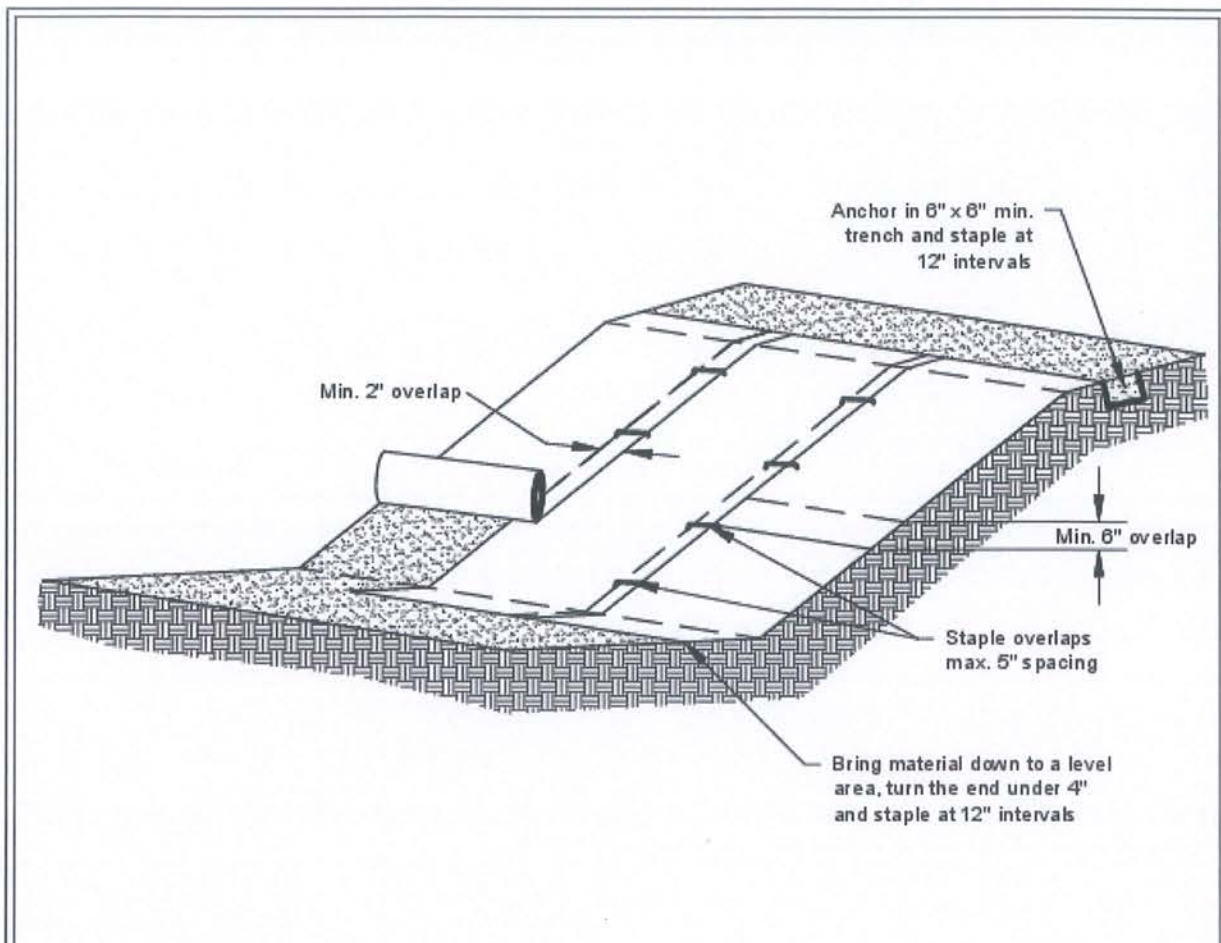

**Notes:**

1. Slope surface shall be smooth before placement for proper soil contact.
2. Stapling pattern as per manufacturer's recommendations.
3. Do not stretch blankets/matting tight - allow the rolls to mold to any irregularities.
4. For slopes less than 3H:1V, rolls may be placed in horizontal strips.
5. If there is a berm at the top of the slope, anchor upslope of the berm.
6. Lime, fertilize, and seed before installation. Planting of shrubs, trees, etc. should occur after installation.

NOT TO SCALE

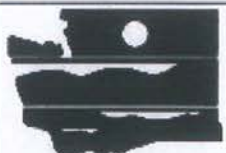

DEPARTMENT OF  
**ECOLOGY**  
State of Washington

**Slope Installation**

Revised June 2016

Please see <http://www.ecy.wa.gov/copyright.html> for copyright notice including permissions, limitation of liability, and disclaimer.

**BMP: General Erosion Control (Cont.)**

**Installation of a geosynthetics mat - Enkamat**

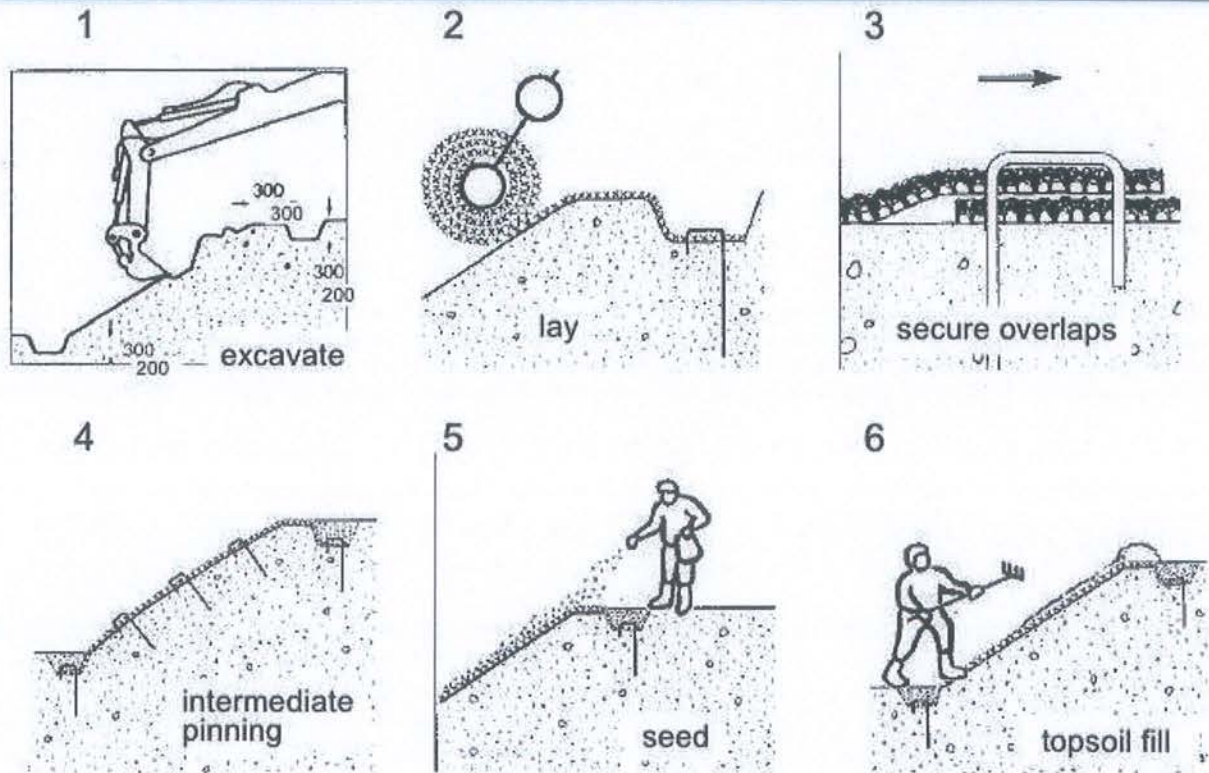



## Erosion Control Measures (Cont.)

**Erosion Control Matting & Silt Fencing**



**Jute netting & Straw-wattles**





## BMP: General Erosion Control (Cont.)

**TABLE 34. Guidelines for erosion and sediment control application**

Timing of application	Technique	Portion of road and construction area treated
Erosion control during construction	Hydromulching, hydroseeding	Road fill slopes, cut slopes, bare soil areas
	Dry seeding	Road fill slopes, cut slopes, bare soil areas
	Wood chip, straw, Excelsior or tackified mulch	Road fill slopes, cut slopes, bare soil areas
	Straw wattles	Road fill slopes and cut slopes
	Gravel surfacing	Road, landing and turnout surfaces
	Dust palliative	Road surfaces
Sediment control during construction	Minimize disturbance (soil and vegetation)	All areas peripheral to construction
	Sediment basin	Roadside ditches, turnouts and small stream crossings
	Sediment traps (e.g., silt fences, straw bales barriers, woody debris barriers)	Road fill slopes, cutbanks, bare soil areas and ditches
	Straw bale dams	Ditches and small streams
	Sumps and water pumps	Stream channels and stream crossings
	Streamflow diversions (e.g., temporary culverts, flex pipe, etc.)	Stream channels and stream crossings
Permanent erosion control	Surface diversion and dispersion devices (pipes, ditches, etc.)	All disturbed bare soil areas
	Road shaping	Road and landing surfaces
	Gravel surfacing	Road, landing and turnout surfaces
	Bituminous or asphalt surfacing	Road surface
	Rolling dips	Road surface
	Ditch relief culverts	Roadbed and road fill
	Downspouts and berm drains	Road fill slopes
	Waterbars	Road and landing surfaces
	Berms	Road surface and roadside areas
	Ditches	Road and landing surfaces
	Riprap	Road fill slopes, stream crossing fills, cutbanks, stream and lake banks
	Soil bioengineering	Road fill slopes, cut slopes, stream crossings, streambanks
Tree planting	Road fill slopes, cutbanks, bare soil areas, stream crossings, streambanks	

HANDBOOK FOR FOREST, RANCH AND RURAL ROADS



## BMP: Permanent Culvert Crossing

- New culvert installations shall be sized to accommodate flows associated with a 100-year storm event.
- If the new culvert is replacing a poorly installed old culvert, the crossing may need to be abandoned to the following standard:
  - When fills are removed they shall be excavated to form a channel that is as close as feasible to natural watercourse grade and orientation, and that is wider than the natural channel.
  - Excavated banks shall be laid back to a 2:1 (50%) or natural slope.
- New culverts shall be placed at stream gradient, or have downspouts, or have energy dissipaters at outfall.
  - Align culverts with the natural stream channel orientation to ensure proper function, prevent bank erosion, and minimize debris plugging. See Figure 97 below.
  - Place culverts at the base of the fill and at the grade of the original streambed or install a downspout past the base of the fill. Downspouts should only be installed if there are no other options.
  - Culverts should be set slightly below the original stream grade so that the water drops several inches as it enters the pipe.
  - Culvert beds should be composed of rock-free soil or gravel, evenly distributed under the length of the pipe.
  - Compact the base and sidewall material before placing the pipe in its bed.
  - Lay the pipe on a well-compacted base. Poor basal compaction will cause settling or deflection in the pipe and can result in separation at a coupling or rupture in the pipe wall.
  - Backfill material should be free of rocks, limbs, or other debris that could dent or puncture the pipe or allow water to seep around the pipe.
  - Cover one end of the culvert pipe, then the other end. Once the ends are secure, cover the center.
  - Tamp and compact backfill material throughout the entire process, using water as necessary for compaction.
  - Backfill compacting will be done in 0.5 – 1.0 foot lifts until 1/3 of the diameter of the culvert has been covered.
  - Push layers of fill over the crossing to achieve the final design road grade, road fill above the culvert should be no less than one-third to one-half the culvert diameter at any point on the drivable surface.
- Critical dips shall be installed on culvert crossings to eliminate diversion potential. Refer to Figure 84 below.
- Road approaches to crossings shall be treated out to the first drainage structure (i.e. waterbar, rolling dip, or hydrologic divide) to prevent transport of sediment.
- Road surfaces and ditches shall be disconnected from streams and stream crossings to the greatest extent feasible. Ditches and road surfaces that cannot be feasibly disconnected from streams or stream crossings shall be treated to reduce sediment transport to streams.
- If downspouts are used, they shall be secured to the culvert outlet and shall be secure on fill slopes.
- Culverts shall be long enough so that road fill does not extend or slough past the culvert ends.
- Inlet of culverts, and associate fill, shall be protected with appropriate measures that extend at least as high as the top of the culvert.
- Outlet of culverts shall be armored with rock if road fill sloughing into channel can occur.
- Armor inlets and outlets with rock, or mulch and seed with grass as needed (not all stream crossings need to be armored).
- Where debris loads could endanger the crossing, a debris catchment structure shall be constructed upstream of the culvert inlet.
- Bank and channel armoring may occur, when appropriate, to provide channel and bank stabilization.

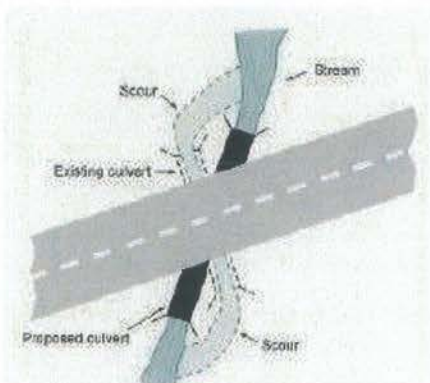

HANDBOOK FOR FOREST, RANCH AND RURAL ROADS

**FIGURE 97.** *Culvert alignment should be in relation to the stream and not the road. It is important that the stream enters and leaves the culvert in a relatively straight horizontal alignment so streamflow does not have to turn to enter the inlet or discharge into a bank as it exits. This figure shows a redesigned culvert installation that replaces the bending alignment that previously existed. Channel turns at the inlet increase plugging potential because wood going through the turn will not align with the inlet. Similarly, channel turns at the outlet are often accompanied by scour against the channel banks (Wisconsin Transportation Information Center, 2004).*



## BMP: Permanent Culvert Crossing Design (Critical Dip and Hydrologic Disconnect Placement)

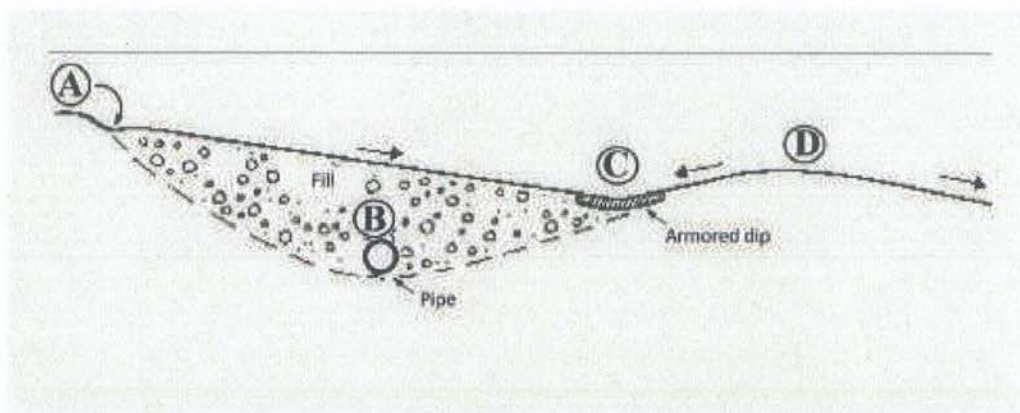
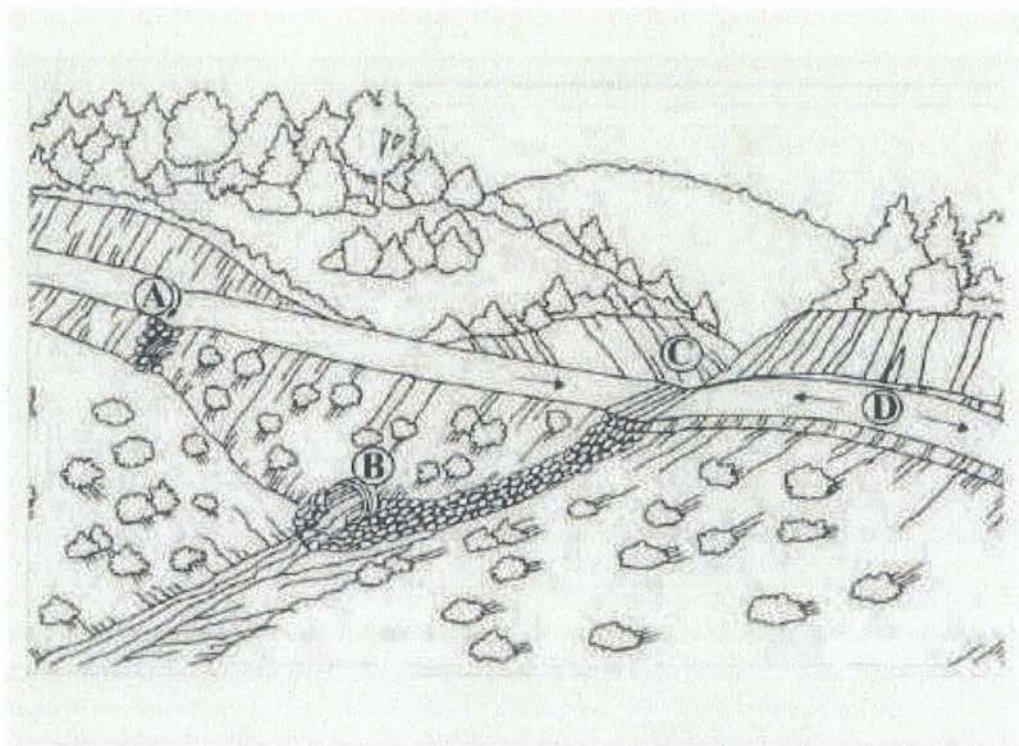
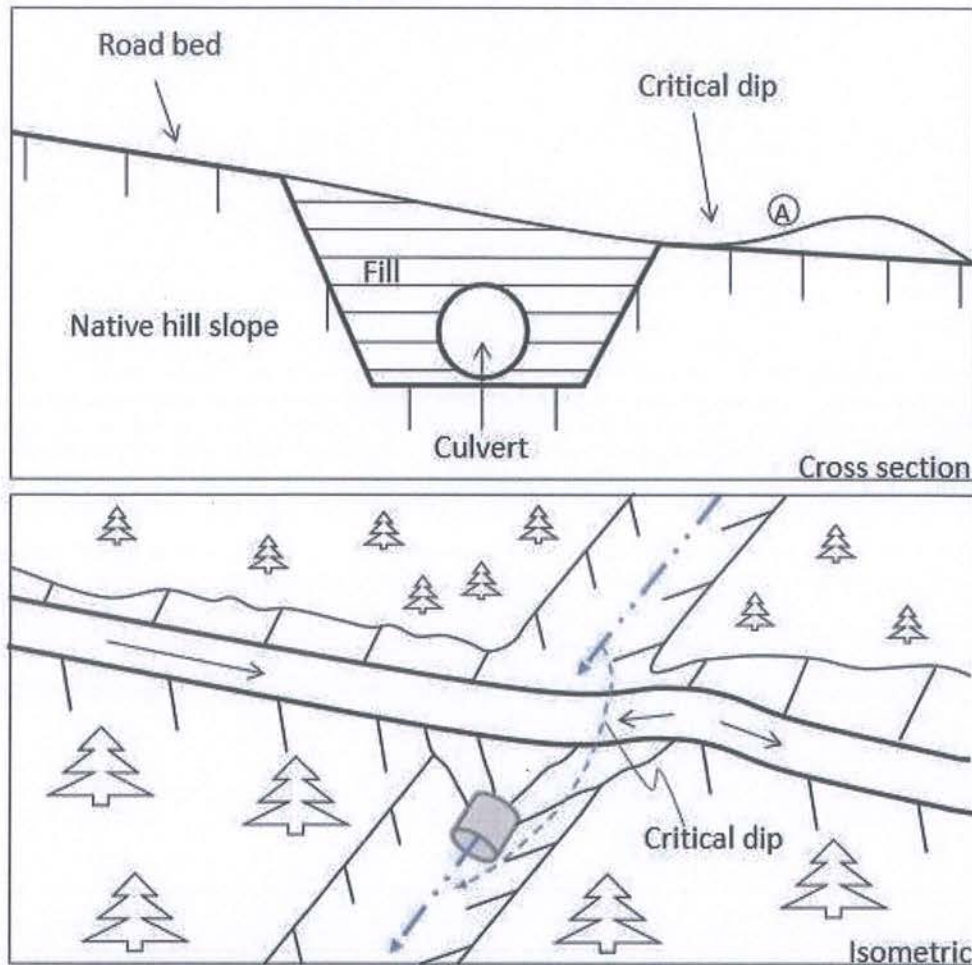

**FIGURE 84.** Critical dips or dipped crossing fills should be centered near a stream crossing's down-road hinge line, not over the centerline of the crossing where overtopping could cause washout or severe erosion of the fill. If the stream crossing culvert (B) plugs, water will pond behind the fill until reaching the critical dip or low point in the crossing (C) and flowing back down into the natural stream channel. The down-road ditch must be plugged to prevent streamflow from diverting down the ditch line. For extra protection in this sketch, riprap armor has been placed at the critical dip outfall and extending downslope to the stream channel. This is only required or suggested on stream crossings where the culvert is highly likely to plug and the crossing fill overtopped. The dip at the hinge line is usually sufficient to limit erosional damage during an overtopping event. Road surface and ditch runoff is disconnected from the stream crossing by installing a rolling dip and ditch relief culvert just up-road from the crossing (A) (Keller and Sherar, 2003).



## BMP: Permanent Culvert Crossing Design (Critical Dip)

### Typical Critical Dip Design for Stream Crossings with Diversion Potential



#### Critical Dip Construction:

1. Critical dip will be constructed on the lower side of crossing.
2. Critical dip will extend from the cutbank to the outside edge of the road surface. Be sure to fill inboard ditch, if present.
3. Critical dip will have a reverse grade (A) from cutbank to outside edge of road to ensure flow will not divert outside of crossing.
4. The rise in the reverse grade will be carried for about 10 to 20 feet and then return to original slope.
5. The transition from axis of bottom, through rising grade, to falling grade, will be in the road distance of at least 15 to 30 feet.
6. Critical dips are usually built perpendicular to the road surface to ensure that flow is directed back into the stream channel.

## BMP: Permanent Culvert Crossing Design (Cofferdam Construction and Use Specifications)

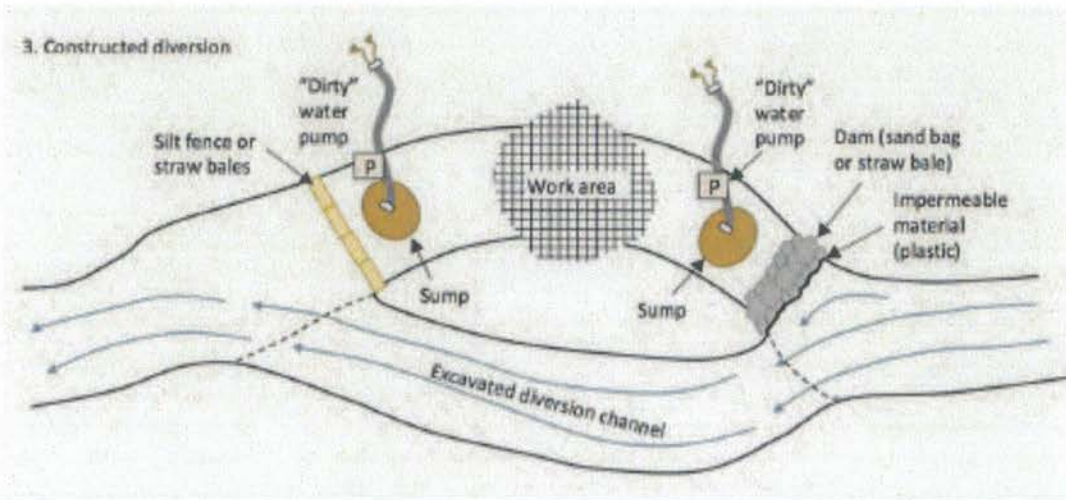
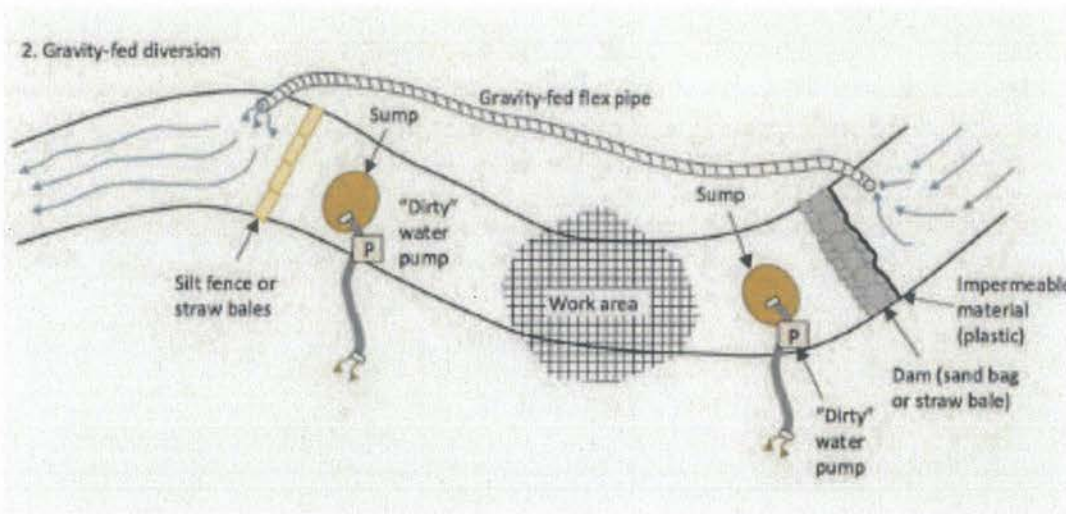
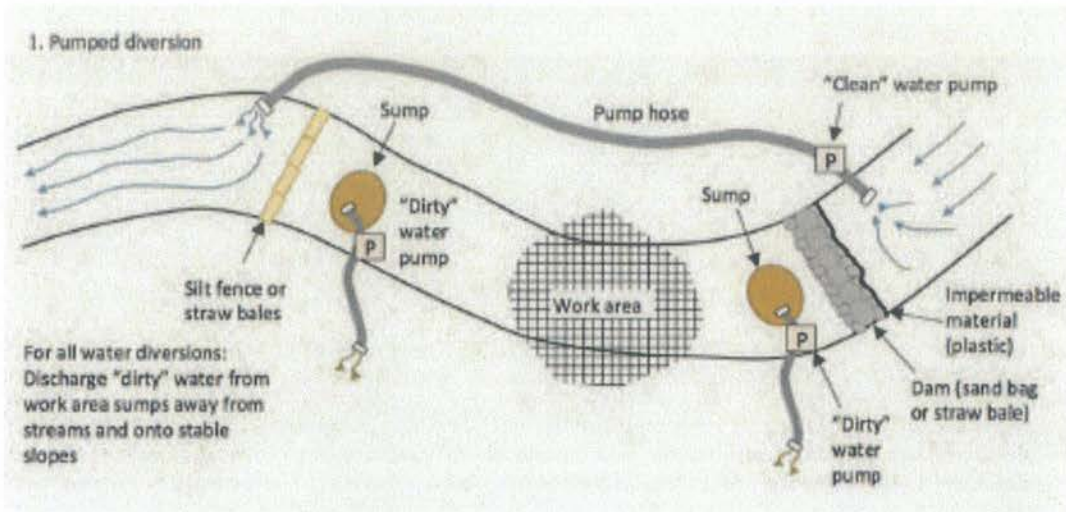



**BMP: Permanent Culvert Crossing Design**  
**(Cofferdam Construction and Use Specifications)**



**FIGURE 197.** Flex pipe stream diversion around a road construction site. The inlet to this 8 inch diameter flex pipe inlet collects clear streamflow from a retention dam above the project site and gravity feeds it around the project area and back into the natural channel downstream from construction work (see photo).



**FIGURE 198.** Sand bag retention dam on this small stream was used to pond streamflow so it could be pumped around a culvert installation site. The green intake hose is screened to keep out rocks and debris while the red pump hose extends several hundred feet around the project work area.



**FIGURE 199.** For larger streams, pump trucks, large pumps or multiple small pumps can be used to pump streamflow around project work sites. Here, a pump truck is used to temporarily divert flow in a fish bearing stream where dual culverts are being replaced with a railcar bridge. Young fish were removed from this fish bearing stream before project work started.



## BMP: Permanent Culvert Crossing Design (Culvert Orientation)

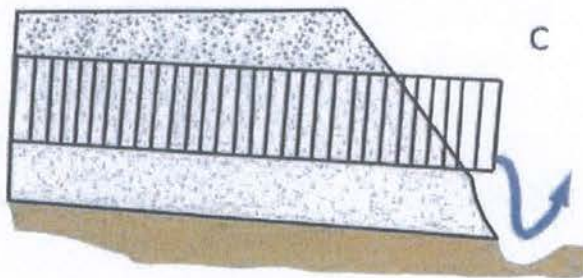
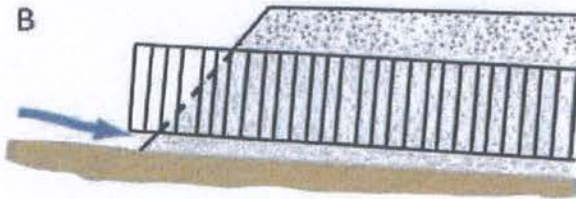

**FIGURE 155.** Proper culvert installation involves correct culvert orientation, setting the pipe slightly below the bed of the original stream, and backfilling and compacting the fill as it is placed over the culvert. Installing the inlet too low in the stream (A) can lead to culvert plugging, yet if set too high (B) flow can undercut the inlet. If the culvert is placed too high in the fill (C), flow at the outfall will erode the fill. Placed correctly (D), the culvert is set slightly below the original stream grade and protected with armor at the inlet and outlet. Culverts installed in fish-bearing stream channels must be inset into the streambed sufficiently (>25% embedded) to have a natural gravel bottom throughout the culvert (Modified from: MDSL, 1991).



**BMP: Permanent Culvert Crossing Design (Inlet and Outlet Armoring)**

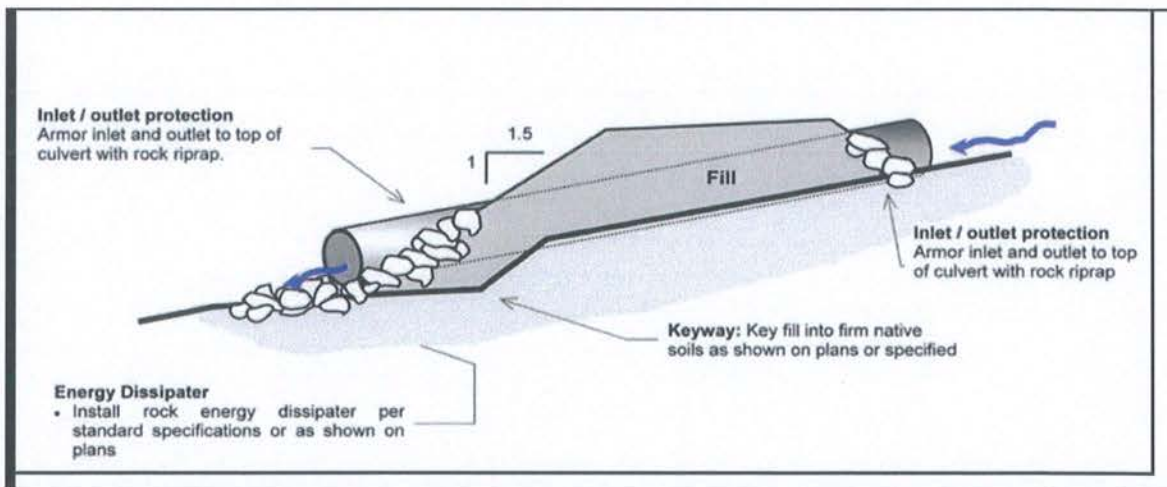
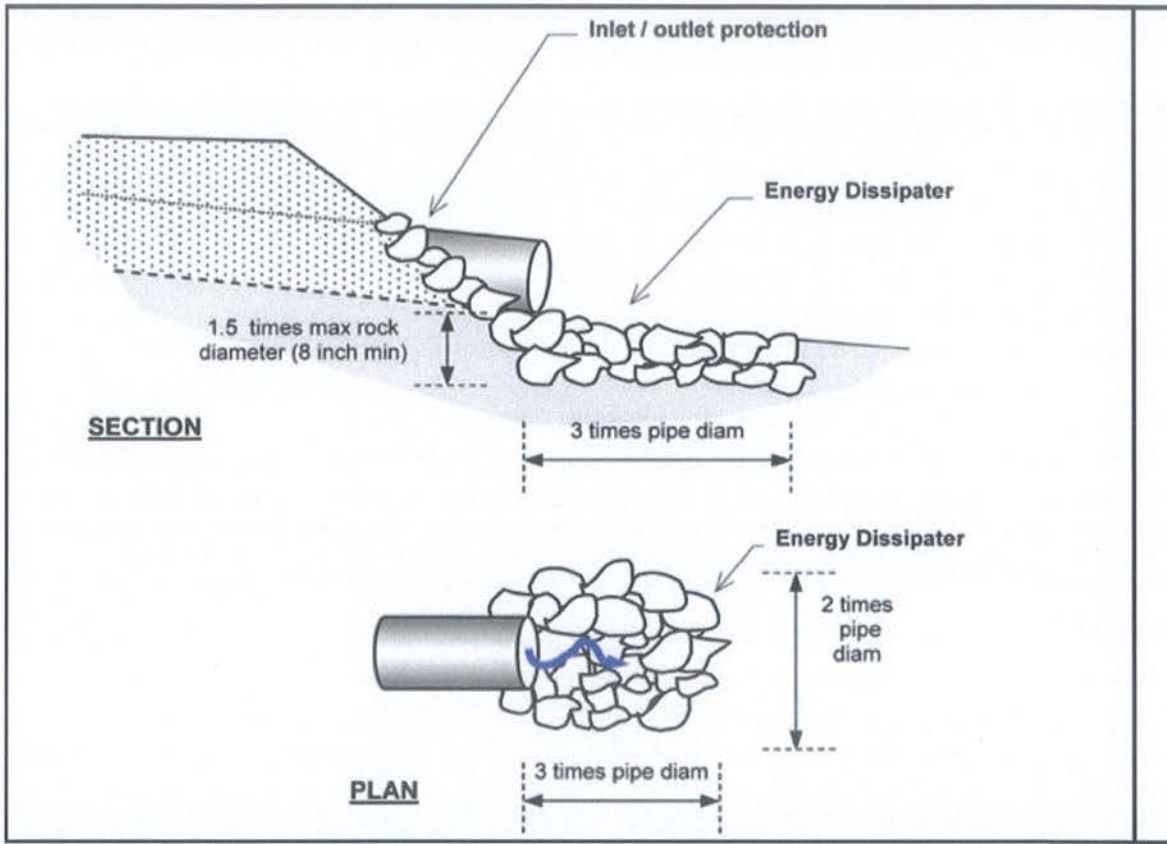

Riprap installed to protect the inlet and outlet of a stream crossing culvert from erosion or for energy dissipation should be keyed into the natural channel bed and banks to an approximate depth of about 1.5x the maximum rock thickness. Riprap should be placed at least up to the top of the culvert at both the inlet and outlet to protect them from splash erosion and to trap any sediment eroded from the newly constructed fill slope above.

## **BMP: Permanent Culvert Crossing Design (Inlet and Outlet Armoring) Cont.**

- Inlets of culverts and associate fills shall be protected with rock armoring that extends at least as high as the top of the culvert.
- Outlets of culverts shall be provided a rocked energy dissipater at the outfall of the culvert.
- Outlets of culverts and associate fills shall be protected with rock armoring that extends at least as high as the top of the culvert if road fill sloughing into channel can occur.
- Prior to inlet and outlet rocking, the inlet and outlets shall be prepared. Preparation will include removal of vegetation and stored materials from the inlet and outlet.
- Inlets may require construction of an inlet basin.
- Slopes at the outlet should be shaped to a 2:1 or natural slope prior to placing rock armor.
- Rock used at culvert inlets and outlets should be a matrix of various sized rocks and rip-rap that range from a 3" dia. to a 2' dia.
- The largest rocks should be places at the base of the culvert or fill. Incrementally smaller rocks shall be placed over the larger rocks at the armoring extend up the slope. Voids and spaces shall be back filled with smaller gravels and rocks.

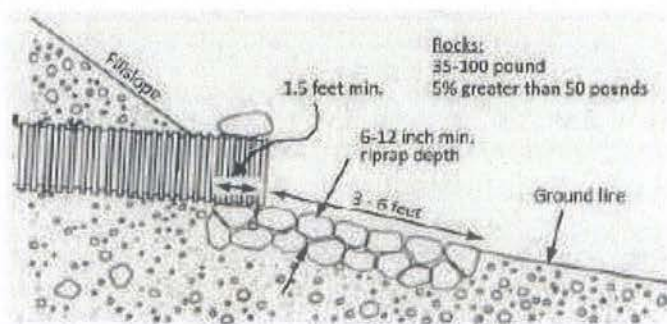

FIGURE 107A. Riprap armor at culvert outlet (Modified from: Keller et al., 2011).

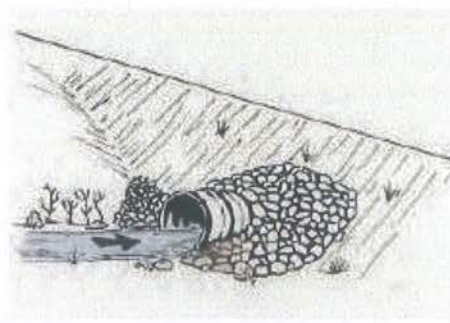

FIGURE 107B. Riprap armor at culvert inlet (Keller and Sherar, 2003).

HANDBOOK FOR FOREST, RANCH AND RURAL ROADS

## **BMP: Stream Bank Armoring (Riprap)**

- Riprap should be installed on top of geotextile fabric or a clean mixture of coarse gravel and sand.
- The riprap should be keyed into the streambed and extend below the maximum expected scour depth with an adequately sized key base width at a thickness of a minimum of 2x the median (D50) rock diameter with the largest stone sizes placed at the base of the riprap structure.
- The armor should be set into the streambank so it does not significantly protrude into, or constrict, the natural channel, or otherwise reduce channel capacity.
- The riprap should extend along the length of unstable or over steepened bank and up the bank sufficiently to encompass the existing bank instability and/or design flood elevations.



## BMP: Rolling Dip Design and Placement

- Rolling dips are drainage structures designed to force surface water to be drained from the road surface.
- The road shall dip into, and rise out of, the rolling dip to eliminate the potential of road surface runoff to run further down road way.
- The rolling dip shall be constructed with clean native materials or rock surfaced where specified.
- The rolling dips outlet may be armored to resist down-cutting and erosion of the outboard road fill.
- Do not discharge rolling dips into any areas that show signs of instability or active landsliding.
- If the rolling dip is designed to divert both road surface and ditch runoff, block the down-road ditch with compacted fill in order to force all ditch flows through the trough (low point) of the rolling dip.

## BMP: Rocked Rolling Dip Design and Placement

- Rocked rolling dips are drainage structures designed to carry known sources of surface water across road ways or from known persistently wet segments of road such as swales without defined watercourses or road segments with heavy bank/road seepage.
- The road shall dip into, and rise out of, the rocked rolling dip to minimize diversion potential.
- The rocked rolling dip shall be constructed with clean rock that is large enough to remain in place during peak flows. Rock size shall vary relative to the anticipated flow through the dip with larger rock used in location where greater flow is anticipated.
- The rocked rolling dips inlet and outlet shall be armored to resist down-cutting and erosion.
- The entire width of the rocked rolling dip shall be rock armored to a minimum of 5-feet from the centerline of the dipped portion of the rolling dip.
- If a keyway is necessary, the rocked rolling dip keyway at the base of the dip shall be of sufficient size, depth and length to support materials used in the rocked rolling dip construction back up to the road crossing interface.
- Do not discharge rolling dips into any areas that show signs of instability or active landsliding.
- If the rolling dip is designed to divert both road surface and ditch runoff, block the down-road ditch with compacted fill.
- The rolling dip should be designed as a broad feature ranging from 10-100 feet long so that it is drivable by most types of vehicular traffic and not significantly inhibit traffic and road use.

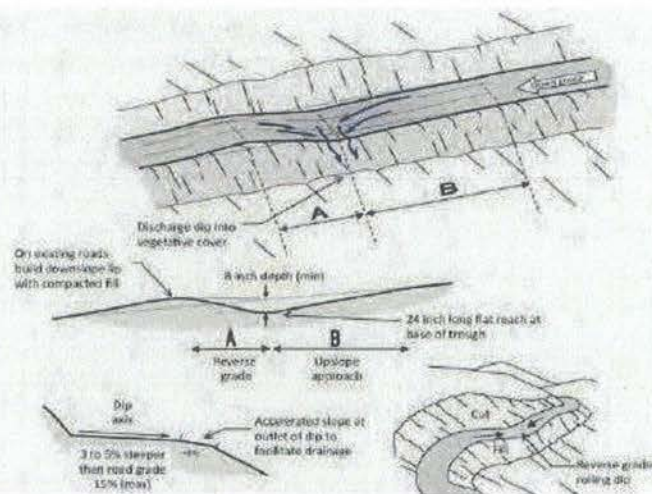
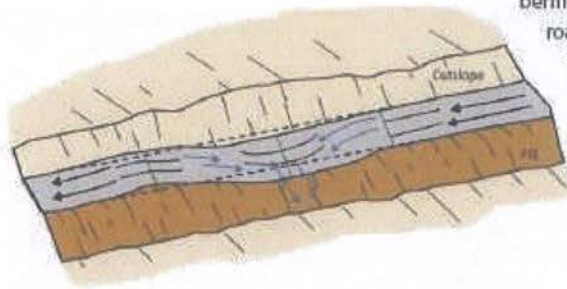

**FIGURE 34.** A classic Type I rolling dip, where the excavated up-road approach (B) to the rolling dip is several percent steeper than the approaching road and extends for 60 to 80 feet to the dip axis. The lower side of the structure reverses grade (A) over approximately 15 feet or more, and then falls down to rejoin the original road grade. The dip must be deep enough that it is not obliterated by normal grading, but not so deep that it is difficult to negotiate or a hazard to normal traffic. The outward cross-slope of the dip axis should be 3% to 5% greater than the up-road grade (B) so it will drain properly. The dip axis should be out-sloped sufficiently to be self-cleaning, without triggering excessive downcutting or sediment deposition in the dip axis (Modified from: Best, 2013).

HANDBOOK FOR FOREST, RANCH AND RURAL ROADS

## BMP: Rolling Dip Design and Placement (Types)

### Type 1 Rolling Dip (Standard)



Type 1 rolling dips are used where road grades are less than about 12-14% and road runoff is not confined by a large through cut or berm. The axis of the dip should be perpendicular to the road alignment and sloped at 3-4% across the road tread. Steep roads will have longer and more abrupt dip dimensions to develop reverse grade through the dip axis. The road tread and/or the dip outlet can be rocked to protect against erosion, if needed.

### Type 2 Rolling Dip (Through-cut or thick berm road reaches)

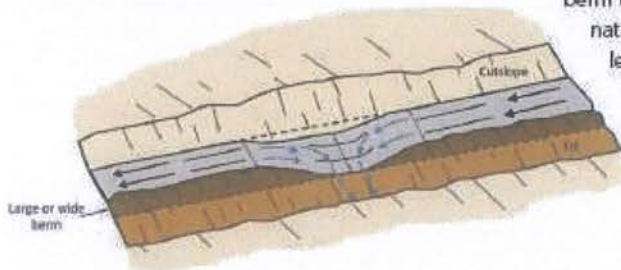

Type 2 rolling dips are constructed on roads up to 12-14% grade where there is a through cut up to 3 feet tall, or a wide or tall berm that otherwise blocks road drainage. The berm or native through cut material should be removed for the length of the dip, or at least through the axis of the dip, to the extent needed to provide for uninterrupted drainage onto the adjacent slope. The berm and slope material can be excavated and endhauling, or the material can be sidecast onto native slopes up to 45%, provided it will not enter a stream.

### Type 3 Rolling Dip (Steep road grade)

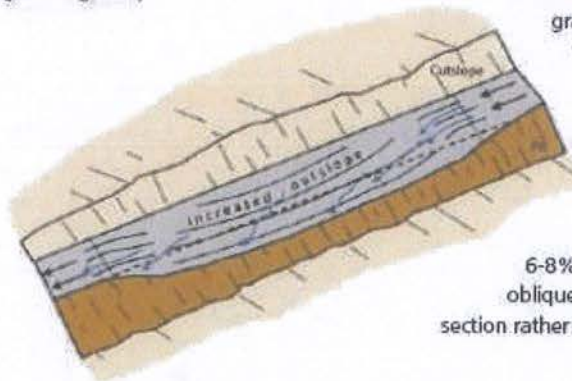

Type 3 rolling dips are utilized where road grades are steeper than about 12% and it is not feasible to develop a reverse grade that will also allow passage of the design vehicle (steep road grades require more abrupt grade reversals that some vehicles may not be able to traverse without bottoming out).

Instead of relying on the dip's grade reversal to turn runoff off the roadbed, the road is built with an exaggerated outslope of 6-8% across the dip axis. Road runoff is deflected obliquely across the dip axis and is shed off the outsloped section rather than continuing down the steep road grade.

FIGURE 36. Rolling dip types



## BMP: Rolling Dip Design and Placement

**FIGURE 33A.**

*Rolling dip constructed on a rock surfaced rural road. The rolling dip represents a change-in-grade along the road alignment and acts to discharge water that has collected on, or is flowing down, the road surface. This road was recently converted from a high maintenance, insloped, ditched road to a low maintenance, outsloped road with rolling dips.*



**FIGURE 33B.**

*This side view of an outsloped road shows that the rolling dip does not have to be deep or abrupt to reverse road grade and effectively drain the road surface. This outsloped forest road has rolling dips that allow all traffic types to travel the route without changing speed.*





## **BMP: Storage Bladders**

- Storage bladders shall be located and designed to minimize the potential for impacts due to rolling and/or failure. Storage bladders should be stored on flat slopes where stability will not be affected.
- Storage bladders shall be located to minimize the potential for water to flow into a watercourse in the event of a catastrophic failure.
- Bladders shall not be used unless the bladder is safely contained within a secondary containment system with sufficient capacity to capture 110 percent of a bladders maximum volume in the vent of bladder failure.
- Secondary containment is recommended in the form of a dirt berm, containment pit, combination of both, or impermeable material with skeletal support. The containment should be capable of holding 110 percent of the bladders volume.
- Secondary containment systems shall be of sufficient strength and stability to withstand the forces of released contents in the event of catastrophic bladder failure.
- Secondary containment systems that are exposed to precipitation shall be designed and maintained with sufficient capacity to accommodate precipitation and storm water inputs from a 25-year, 24-hour storm event.
- Bladders and containment systems shall be periodically inspected to ensure integrity.



*This is an example of a containment pit which will assist in mitigating the impacts if this storage bladder failed.*



### Monitoring Plan

Cannabis cultivators shall regularly inspect and maintain the condition of access roads, access road drainage features, and watercourse crossings. At a minimum, cannabis cultivators shall perform inspections prior to the onset of fall and winter precipitation and following storm events that produce at least 0.5 in/day or 1.0 inch/7 days of precipitation. See Required Monitoring tables below for site specific monitoring and reporting requirements. Cannabis cultivators are required to perform all of the following maintenance:

- Remove any wood debris that may restrict flow in a culvert.
- Remove sediment that impacts access road or drainage feature performance.
- Place any removed sediment in a location outside the riparian setbacks and stabilize the sediment.
- Maintain records of access road and drainage feature maintenance for annual reporting.

Cannabis cultivators that are operating in areas that are, or may become, inaccessible during winter months due to extreme weather such as snow, road closures, seasonal access roads to the property, or any other such conditions shall make additional efforts to enhance winterization measures in the absence of monitoring during storm events.

### Monitoring Requirements

(Tier 1, Low Risk, < 1 acre of cultivation)

Monitoring Requirement	Description
Winterization Measures Implemented	Report winterization procedures implemented, any outstanding measures, and the schedule for completion.
Tier Status Confirmation	Report any changes in the tier status.
Third Party Identification	Report any change in third party status as appropriate.

### Annual Reporting

Annual Reports shall be submitted to the North Coast Regional Water Quality Control Board by March 1<sup>st</sup> following the year being monitored. Annual Reporting for this enrollment shall be submitted by March 1<sup>st</sup>, 2021, and report on monitoring done during the 2020 calendar year. Annual reporting is required each subsequent year of enrollment.

# Attachments



## Implementation of Applicable BPTC Measures

Assessment of applicable BPTC measures consisted of a field examination on September 1, 2020. Anywhere applicable BPTC measures are not met on the property, descriptions of the assessments, and the prescribed treatments are outlined following each associated section below.

### Summary of BPTC Measures Compliance

1. Sediment Discharge BPTC Measures Y/N
2. Fertilizer, Pesticide, Herbicide, and Rodenticide BPTC Measures Y/N
3. Petroleum Product BPTC Measures Y/N
4. Trash/Refuse, and Domestic Wastewater BPTC Measures Y/N
5. Winterization BPTC Measures Y/N

### 1. Sediment Discharge BPTC Measures

#### 1.1. Site Characteristics

- 1.1.1. Provide a map showing access roads, vehicle parking areas, streams, stream crossings, cultivation site(s), disturbed areas, buildings, and other relevant site features.

**See attached Site Map.**

- 1.1.2. Describe the access road conditions including estimating vehicle traffic, road surface (e.g., paved, rocked, or bare ground), and maintenance activities. Describe how storm water is drained from the access road (e.g., crowned, out slope, armored ditch, culverts, rolling dips, etc.).

**See section "Land Development and Maintenance, Erosion Control, and Drainage Features" above, the attached Mitigation Report, Site Maps, and Treatment Implementation Schedule for site specific descriptions, treatments, and the implementation schedule.**

- 1.1.3. Describe any vehicle stream crossing including the type of crossing (e.g., bridge, culvert, low water, etc.).

**See the section titled "Stream Crossing Installation and Maintenance" or the attached Mitigation Report and Site Maps for site specific details and treatment schedules.**

- 1.1.3.1. For Region 1 Dischargers, identify, discuss, and locate on the site map any legacy waste discharge issues that exist on the property.

**Not applicable. No legacy waste discharge issues were identified during the assessment of the property.**

- 1.2. Sediment Erosion Prevention and Sediment Capture (Moderate risk Tier 1 or Tier 2 Dischargers are required to submit a Site Erosion and Sediment Control Plan. Those Dischargers may refer to that plan rather than repeat it here)

1.2.1. Erosion Prevention BPTC Measures

- 1.2.1.1. Describe the BPTC measures that have been, or will be implemented to prevent or limit erosion. Provide an implementation schedule for BPTC measures that have not yet been implemented. Identify the erosion prevention BPTC measures on a site map.

**See section "Land Development and Maintenance, Erosion Control, and Drainage Features" and attached Mitigation Report, Site Maps, and Treatment Implementation Schedule for site specific descriptions of physical BPTC measures being prescribed.**

- 1.2.1.1.1. The description shall address physical BPTC measures, (e.g., placement of straw mulch, plastic covers, slope stabilization, soil binders, culvert outfall armoring, etc.) and biological BPTC measures (vegetation preservation/replacement, hydro seeding, etc.).

**See the attached Mitigation Report and Best Management Practices (BMPs) for descriptions of physical BPTC measures being prescribed.**

1.2.2. Sediment Control BPTC Measures

- 1.2.2.1. Describe the BPTC measures that have been, or will be implemented to capture sediment that has been eroded. Provide an implementation schedule for BPTC measures that have not yet been implemented. Identify the sediment control BPTC measures on a site map.

**Not applicable. No BPTC measures have been or will need to be, implemented to capture sediment that has been eroded.**

- 1.2.2.1.1. The description shall address physical BPTC measures, (e.g., placement of silt fences, fiber rolls, or settling ponds/areas, etc.) and biological BPTC measures (vegetated outfalls, hydro seeding, etc.).

**There are no biological BPTC measures being prescribed.**

1.2.3. Maintenance Activities - Erosion Prevention and Sediment Control

- 1.2.3.1. Describe how the erosion prevention and sediment control BPTC measures will be monitored and maintained to protect water quality.

**Erosion prevention BPTC measures and all corresponding work shall be inspected prior to and in conjunction with winter monitoring, as**



described above under the “Monitoring Plan” to ensure proper placement, installation, and function remain intact prior to and throughout the Winter Period.

- 1.2.3.2. Describe how any captured sediment will be either stabilized in place, excavated and stabilized on-site, or removed from the site.

**Not applicable.**

- 1.2.4. Erosion control BPTC measures: Describe the interim soil stabilization, if applicable, and long-term BPTC measures implemented to prevent sediment transport at each identified disturbed area(s) and improperly constructed features.

**Not applicable. There was no erosion observed at any of the disturbed areas and there are no improperly constructed features. Disturbed areas are located on gentle slopes surrounded by vegetation and grass buffers.**

**2. Fertilizer, Pesticide, Herbicide, and Rodenticide BPTC Measures**

- 2.1. Provide a summary table that identifies the products used at the site, when they are delivered to the site, how they are stored, and used at the site. If products are not consumed during the growing season, describe how they are removed from the site or stored to prevent discharge over the winter season.

**See comprehensive table under 2.3**

- 2.2. Provide a site map that locates storage locations.

**See attached Site Map. Fertilizers and soil amendments are currently stored properly in sheds west of the cultivation area.**

- 2.3. Describe how bulk fertilizers and chemical concentrates are stored, mixed, applied, and how empty containers are disposed.

**Fertilizer, Pesticides, and Herbicide Products used on Site**

Product	Delivery and Storage	On-site usage	How removed or stored
Botanicare Cal/ Mag	Brought to property as needed. Stored within the sheds with all other fertilizers and amendments over winter or alongside mixing tanks while in use. Stored alongside mixing tanks while in use.	Mixed into tank with water. It is then dripline watered to plants as needed.	Stored within the storage structures over winter. Empty containers are disposed of at an appropriate waste disposal facility.

2.4. Describe procedures for spill prevention and cleanup.

**Fertilizer, pesticides, and herbicide products shall either be stored in a purpose-built structure or within other secured structures over winter.**

### **3. Petroleum Product BPTC Measures**

3.1. Provide a summary table that identifies the products used at the site, when they are delivered to the site, how they are stored, and used at the site. If products are not consumed during the growing season, describe how they are removed from the site or stored to prevent discharge over the winter season.

**See comprehensive table under 3.3.**

3.2. Provide a site map that locates storage locations.

**See attached Site Map.**

3.3. Describe how fuels, lubricants, and other petroleum products are stored, mixed, applied, and empty containers are disposed.

#### **Petroleum Products**

<b>Products used on site</b>	<b>When they are delivered to site</b>	<b>How they are stored and used</b>	<b>How removed or stored</b>
<b>Gasoline</b>	Brought to site when needed throughout the year.	Stored in standard 5-gallon gasoline canisters on the porch of the residence. Used to fuel equipment.	Stored in standard 5-gallon gasoline canisters on the porch of the residences or where it is used.
<b>Motor oil</b>	Brought to site when needed throughout the year.	Stored in the shed alongside the 500-gallon steel fuel tank and the generator. Used to lubricate internal combustion engines.	After oil changes, the used motor oil is stored in either the container it came in or in sealed 5-gallon buckets for later disposal at an appropriate waste disposal facility.

3.4. Describe procedures for spill prevention and cleanup.

**Any/all fuel canisters, motor oil containers, and generators, large or small, shall be stored in secondary containment (e.g. drip pans, plastic totes, or sealed metal boxes) while being stored long term or not in immediate use, wherever these materials are used anywhere on the property. Adequate quantities of absorbent materials are stored at all locations where these types of materials are used, stored, or mixed. Should a spill of these materials occur, absorbent materials will be applied immediately and allowed enough time to absorb as much material as possible. Following treatment, absorbent materials applied as well as any**



contaminated soil will be removed and disposed of appropriately for the spilled material.

#### **4. Trash/Refuse, and Domestic Wastewater BPTC Measures**

- 4.1. Describe the types of trash/refuse that will be generated at the site. Describe how the material is contained and properly disposed of.

**Domestic and commercial cannabis refuse will be generated at the site. The refuse is securely stored in trash bags, trash bins, and a utility trailer at the cultivation areas, residences, and within a contained refuse storage shed adjacent to the residences prior to disposal at an appropriate waste disposal facility.**

- 4.1.1. Provide a site map that locates the trash/refuse storage locations.

**Refuse is stored in trash bags, trash bins, and a utility trailer at mapped cultivation areas and the houses. See attached Site Map.**

- 4.2. Describe the number of employees, visitors, or residents at the site.

**There are two regular employees who are at the site during the cultivation season. Additional employees are brought onto the property for short periods of time to complete projects requiring additional employees. Visitors are occasionally on site, including consultants and regulatory agencies. There is also a full-time residence on the property as well.**

- 4.2.1. Describe the types of domestic wastewater generated at the site (e.g., household generated wastewater or chemical toilet).

**Domestic sewage is generated on site.**

- 4.2.2. Describe how the domestic wastewater is disposed of.

- 4.2.2.1. Permitted onsite wastewater treatment system (e.g., septic tank and leach lines).

**Domestic sewage is disposed of via a septic system.**

- 4.2.2.2. Chemical toilets or holding tank. If so, provide the name of the servicing company and the frequency of service.

**Not applicable.**

- 4.2.2.3. Outhouse, pit privy, or similar. The use of this alternative requires approval from the Regional Water Board Executive Officer; include the approval from the Executive Officer and any conditions imposed for use of this alternative.

**Not applicable.**

- 4.2.2.3.1. Provide a site map that locates any domestic wastewater treatment, storage, or disposal area.

**See attached Site Map for locations of residences with attached septic.**

## **5. Winterization BPTC Measures**

- 5.1. Describe activities that will be performed to winterize the site and prevent discharges of waste. The description should address all the issues listed above.

**See Mitigation Report and Annual Winterization Measures for prescribed general winterization measures that will be performed prior to each Winter Period, and site-specific interim measures that will be performed prior to the Winter Period until permanent, prescribed treatments can be executed.**

- 5.2. Describe maintenance of all drainage or sediment capture features (e.g., drainage culverts, drainage trenches, settling ponds, etc.) to remove debris, soil blockages, and ensure adequate capacity exists.

**Existing drainage structures will be maintained or repaired as feasible and necessary with hand tools during annual winterization and winter monitoring. Prescribed repair and maintenance will be executed in accordance with the Mitigation Report and Treatment Implementation Schedules.**

- 5.3. Describe any revegetation activities that will occur either at the beginning or end of the precipitation season.

**Not applicable.**

- 5.4. If any BPTC measure cannot be completed before the onset of the Winter Period, contact the Regional Water Board to establish a compliance schedule.

**See the attached Mitigation Report and Treatment Implementation Schedule for site descriptions, treatments, and the implementation schedule.**

- 5.5. For Region 1 Dischargers, describe any activities that will be performed to address legacy waste discharge issues. Region 6 Dischargers should consult with Regional Water Board staff to confirm if any other activities in addition to BPTCs are necessary to address legacy waste discharge issues.

**Not applicable. No legacy waste discharge issues were identified during the assessment of the property.**



**Photographs**



*Well rocked permanent road.*



*Main residence.*

**Photographs**

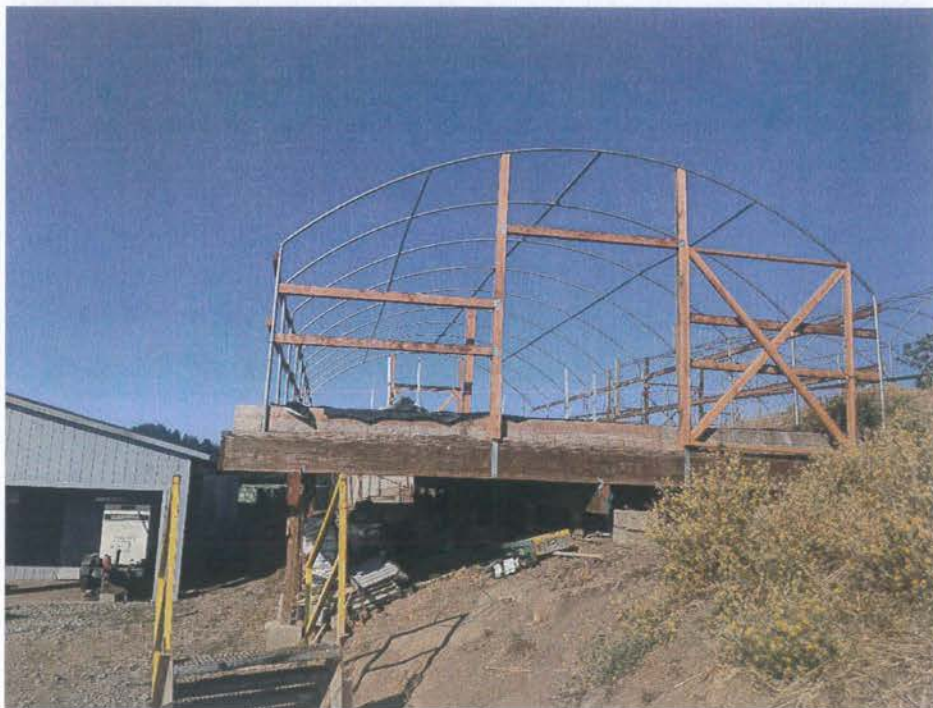

*Cultivation Area A.*

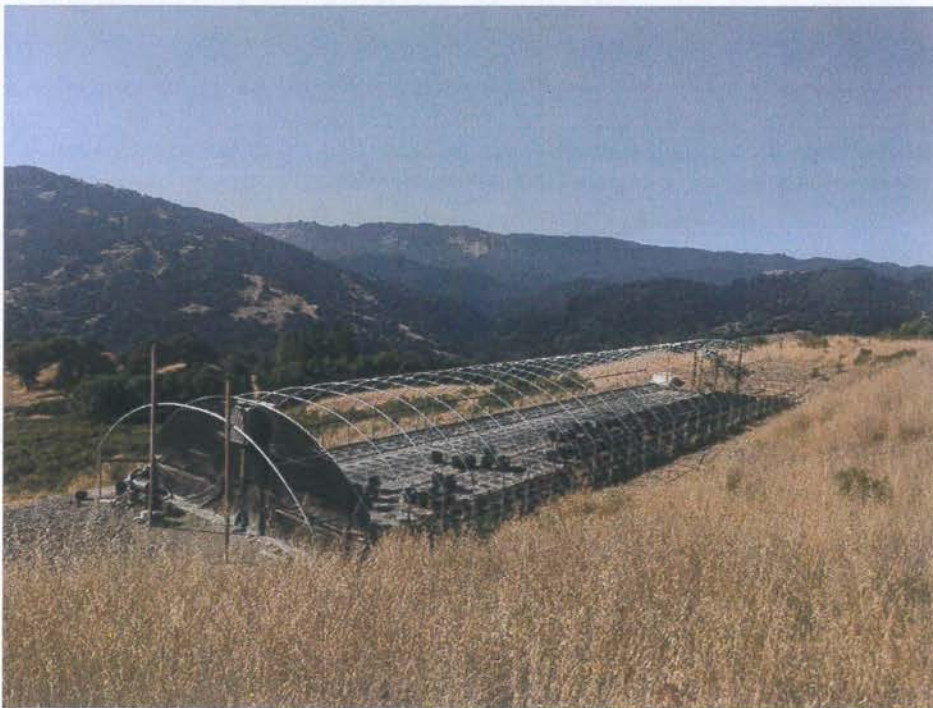

*Cultivation Area B.*



**Photographs**



*Site 08 with untarped potting soil in a riparian setback.*



*On-stream pond.*



**Photographs**



POD #1.



POD #2.



**Photographs**



*Groundwater well.*



*Tank bank #3.*