

# SITE MANAGEMENT PLAN

In fulfillment of

State Water Resources Control Board Order WQ 2017-0023-DWQ  
*General Waste Discharge Requirements and Waiver of Waste Discharge Requirements for  
Discharges of Waste Associated with Cannabis Cultivation Activities*

Prepared for:

## Journey Aquarian

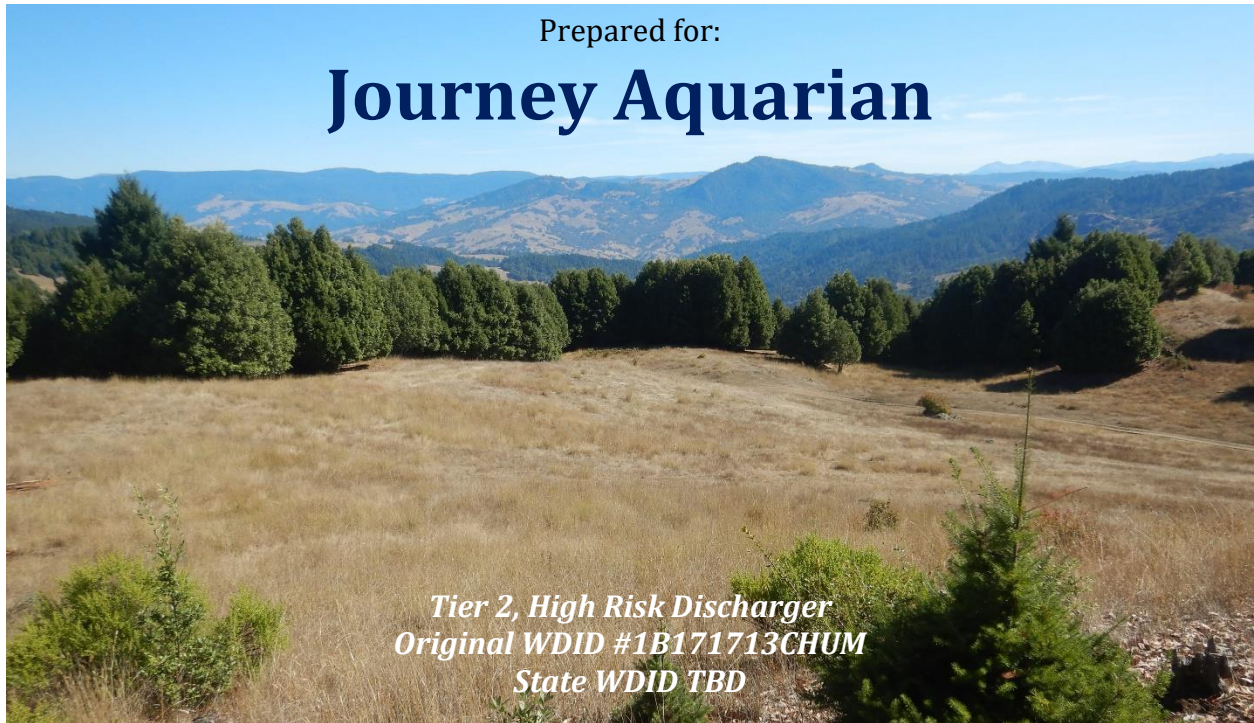

Prepared by:



Lia Nelson

[lia@northpointeureka.com](mailto:lia@northpointeureka.com)

(707) 798-6438 ext. 705

**August 2018**

**Updated September 2019**

## **TABLE OF CONTENTS**

GENERAL INFORMATION

INTRODUCTION

SITE LOCATION AND DIRECTIONS

PROJECT DESCRIPTION

SITE DESCRIPTION

INVENTORY AND ASSESSMENT

TIER AND RISK DESIGNATION

DESCRIPTION OF CANNABIS CULTIVATION ACTIVITIES ON PARCELS

BEST PRACTICABLE TREATMENT OR CONTROL (BPTC) MEASURES

1. Site Maintenance, Erosion Control, and Drainage Features
2. Stream Crossing Maintenance
3. Riparian and Wetland Protection and Management
4. Spoils Management
5. Irrigation Runoff
6. Fertilizer and Soil Amendments
7. Petroleum Product and other Chemicals
8. Cultivation and Waste
9. Refuse and Human Waste
10. Monitoring
11. Reporting

UPDATED BPTC CORRECTIVE ACTIONS TABLE

---

## **APPENDICES**

Appendix A: Site Maps – Disturbed Area Map and BPTC Map

Appendix B: BPTC Measure Specifications

Appendix C: Water Use Records



**GENERAL INFORMATION**

DIVERTER: Journey Aquarian  
610 Dry Creek Road  
Healdsburg, CA 95448

CULTIVATORS: Myers and Aquarian, LLC (operates on 216-135-015)  
610 Dry Creek Road  
Healdsburg, CA 95448

Humboldt Kingz, LLC (operates on 216-136-004 / 216-135-008)  
24534 Townsend Avenue  
Hayward, CA 94544

Journey Aquarian (operates on 216-081-013)  
610 Dry Creek Road  
Healdsburg, CA 95448

PROPERTY OWNER: Journey Aquarian (216-081-013, 216-135-015, 216-135-008, 216-136-004)  
610 Dry Creek Road  
Healdsburg, CA 95448

Myers and Aquarian, LLC (216-135-010)  
610 Dry Creek Road  
Healdsburg, CA 95448

SITE ADDRESS: 444 Harris Road (216-081-013)  
Garberville, CA 95542

1200 Harris Road (216-135-015)  
Garberville, CA 95542

2121 Harris Road (216-135-008, 216-136-004)  
Garberville, CA 95542

ACRES: 216-081-013-000 – 122 acres (per *Humboldt County Web GIS*)  
216-135-015-000 – 240 acres (per *Humboldt County Web GIS*)  
216-135-010-000 – 161 acres (per *Humboldt County Web GIS*)  
216-135-008-000 / 216-136-004 – 164 acres (per *Humboldt County Web GIS*)

---

**INTRODUCTION**

Effective September 12, 2017, Journey Aquarian enrolled with the North Coast Regional Water Quality Control Board (NCRWQCB) for coverage under Tier 2 of Order No. 2015-0023 *Waiver of Waste Discharge Requirements and General Water Quality Certification for Discharges of Waste Resulting from Cannabis Cultivation and Associated Activities or Operations with Similar Environmental Effects in the North Coast Region*<sup>1</sup> (WDID Number 1B171713CHUM). The original

---

<sup>1</sup> [https://www.waterboards.ca.gov/northcoast/water\\_issues/programs/cannabis/#\\_Waiver\\_of\\_Waste](https://www.waterboards.ca.gov/northcoast/water_issues/programs/cannabis/#_Waiver_of_Waste)



document, a Water Resources Protection Plan (WRPP), was developed to satisfy conditions of the Tier 2 enrollment requirements of Order No. 2015-0023 (Order). This WRPP has been updated to include recent project developments and include Site Management Plan information.

On June 30<sup>th</sup>, 2019, Journey Aquarian enrolled for Tier 2, High Risk coverage under the State Water Resources Control Board (SWRCB) General Order WQ 2017-0023-DWQ *General Waste Discharge Requirements and Waiver of Waste Discharge Requirements for Dischargers of Waste Associated with Cannabis Cultivation Activities*<sup>2</sup> (“SWRCB Order”) (Application Number 419653). A statewide WDID number has yet to be assigned. The purpose of the SWRCB Order is to implement the requirements for waste discharges associated with cannabis cultivation as described in SWRCB’s *Cannabis Cultivation Policy – Principles and Guidelines for Cannabis Cultivation* (“SWRCB Policy”). The SWRCB Policy provides a structure for managing water quality and instream flow impacts associated with cannabis cultivation. It also establishes criteria for personal use and site conditional exemptions and includes a tiered approach for permitting discharges of waste. All eligible dischargers developing land for cannabis cultivation activities are required to enroll in the program under the Order. Dischargers must implement Best Practicable Treatment or Control (BPTC) measures and submit technical and monitoring reports to assure compliance with the Order. This Site Management Plan (SMP) describes how the discharger is complying with the applicable BPTC measures listed in the SWRCB Order/Policy and how they are being implemented property wide.

### **SITE LOCATION AND DIRECTIONS**

The project site is located off of Harris Rd., just north of the locality of Harris. To reach the site from Eureka, take US-101 South for 66 miles to exit 639b for Garberville. Turn right on to Redwood Dr. and take another right on to Alderpoint Rd. Travel on Alderpoint Rd. for 8 miles and take a right on to Bell Springs Rd. Travel for 2.5 miles and take a left onto Harris Rd. Travel for .7 miles to reach APN 216-135-015, where the driveway is on the left. To reach APN 216-135-015, travel for .2 more miles on Harris Rd. and the driveway will be on your left. To reach APN 216-135-010, travel .8 more miles on Harris Rd., which drives straight through the parcel and does not have a driveway. To reach APNs 216-135-008 & 216-136-004, travel .9 more miles on Harris Rd. and the driveway will be on the right.

### **PROJECT DESCRIPTION**

This SMP is being prepared for five contiguous Assessor’s Parcel Numbers (APNs): 216-136-004 and 216-135-008 (“Pond”), 216-135-015 (“Thunder”), 216-081-013 (“Ranch”), and 216-135-010 (“Quarry”). Journey Aquarian has three (3) active applications under various LLCs (including Myers and Aquarian, LLC, Rose Kingz, LLC, and Humboldt Kingz, LLC) under Humboldt County’s *Commercial Medical Marijuana Land Use Ordinance (CMMLUO)*<sup>3</sup>: A Conditional Use Permit for 43,560 square feet (sf) of outdoor cultivation on the “Pond” parcels (Apps #1212), a Zoning Clearance Certificate for 10,000 sf of outdoor cultivation the “Ranch” parcel (Apps # 12121), and a Conditional Use Permit for 24,000 sf of outdoor cultivation on the “Thunder” parcel (Apps # 12124). Journey Aquarian of Myers and Aquarian was issued an interim permit from Humboldt County to cultivate 24,000 sf on the “Thunder” parcel. A second interim permit for the “Pond” parcel was issued for 37,250 sf of outdoor cultivation, and a third interim permit was issued to cultivate 10,000 sf on the “Ranch” parcel.

### **SITE DESCRIPTION**

The project site is in the Jewett Creek HUC 12 Watershed (#180101050404) and the Middle Main Stem of the Eel River Planning Watershed. Perington Creek and its tributaries enter the parcels from

---

<sup>2</sup> [https://www.waterboards.ca.gov/water\\_issues/programs/cannabis/cannabis\\_water\\_quality.html](https://www.waterboards.ca.gov/water_issues/programs/cannabis/cannabis_water_quality.html)

<sup>3</sup> <https://humboldt.gov/2124/Medical-Marijuana-Land-Use-Ordinance>



the west and flow easterly, with scattered springs and steep. The parcels have undulating topography, with slopes varying from less than 5% to greater than 30%. Existing built infrastructure includes a mobile home, cultivation areas, and cultivation-related storage areas, located primarily in the flatter areas of the parcel on less than 30% slopes. Vegetation consists of open grasslands mixed with oak woodlands, manzanitas, madrones, and mixed conifer species. The soils within the parcel consist predominantly of Yorknorth-Witherell complexes (15-50% slopes), which are moderately well-drained silty clay loam soils<sup>4</sup>.

The Site has a General Plan Designation of Agricultural Grazing (AG), and various zonings across the parcels including Agricultural Exclusive (AE), Agricultural Exclusive with Special Building Site Combining Zone (AE-B-5(160)), and Timber Production Zone (TPZ). Surrounding parcels are zoned AE, TPZ, and Unclassified (U) and have General Plan Land Use classifications of Timberland (T), Residential Agriculture (RA40-160), and Agriculture Grazing (AG).

The project parcels have numerous Class II and III watercourses that primarily drain east toward Perington Creek, a Class I stream. Perington Creek is a tributary of Jewett Creek, which drains into the mainstem Eel River, located approximately 3.5 miles Northeast of the property. While Jewett Creek has historic and current populations of Rainbow and Steelhead Trout (*O. Mykiss*), historic data shows that Perington Creek has not historically been a salmonid-bearing stream. A natural sheet of bedrock on Jewett Creek has been identified as a potential barrier to fish passage, which likely prevents finfish from spawning in Perington Creek or within the subject parcel<sup>5</sup>. Perington Creek has steep and incised channels with limited salmonid habitat potential. The mainstem Eel River have been listed as impaired waterbodies under Section 303(d) of the Clean Water Act<sup>6</sup>.

## **INVENTORY AND ASSESSMENT**

Office analysis and a field inventory were used to assess the property for compliance with the Standard Conditions as listed in Order Provision I.A. Pre-field inspection, an air photo analysis (google earth and air photos) was used to identify existing infrastructure, watercourses, and general layout of the property. The field inventory was conducted in July of 2017 by the engineering staff of Manhard Consulting, which has since closed, and analyzed by the engineering staff of NorthPoint Consulting. Numerous site investigations have been conducted since then to obtain updated site information. Site inventory included GPS mapping of structures, water tanks, ponds, roads, agricultural sites and other infrastructure features. GPS was also used to map watercourse features including: extent of streams, riparian zones, and ditches. Aerial imagery was also analyzed to update the SMP.

Water systems were evaluated for their source, storage, and use. Points of diversions were mapped and photographed, with data collected for analysis regarding stream type and the diversion method. Elements of the water storage system were mapped, and data was collected on the number and size of tanks and bladders, pumping system, efficiency, stability, and potential for catastrophic failure. All aspects of the water system were evaluated for existing erosion and the potential for sediment delivery to the stream network. Assessment of seasonal diversion rates, storage, and water use were calculated in the office. Upgrade and treatment recommendation for the water system were developed using field observation and office analysis. Information on the current and planned use of buildings was collected. Structures that contained fertilizers, petroleum products, or pesticides associated with cannabis cultivation were inventoried to assess proper storage.

---

<sup>4</sup> <https://websoilsurvey.sc.egov.usda.gov/App/WebSoilSurvey.aspx>

<sup>5</sup> Ross Taylor and Associates. 2000. Humboldt County Culvert Inventory and Fish Passage Evaluation – Final Report.

<sup>6</sup> [https://ofmpub.epa.gov/waters10/attains\\_waterbody.control?p\\_au\\_id=CAR1114106119990601095147&p\\_cycle=2010](https://ofmpub.epa.gov/waters10/attains_waterbody.control?p_au_id=CAR1114106119990601095147&p_cycle=2010)



Roads were evaluated to identify and prescribe treatment for discharges and controllable sediment delivery sites. The road network was examined for opportunities to discontinued use and restoration of high sediment risk roads. Road surfaces, cutbanks, and fillslopes were examined for rills, gullies and surface erosion delivering sediment to the stream network. Road drainage was evaluated for effectiveness in routing water away from watercourse and maintaining road stability. Stream crossings were evaluated for ability to pass the 100-year storm event (in office), potential for plugging, and erosion of the fill slopes. Location of treatment recommendations were mapped and incorporated into the design plan set in the office.

Cannabis cultivation sites were evaluated for controllable sediment delivery sites, irrigation runoff, waste disposal, and storage of petroleum, fertilizers, and other chemicals used in the cultivation process. Proximity of cultivation areas to riparian zones, wetlands, and streams was recorded (see Tables 1a-c in Section 3, below). Operators were consulted for information on the rate and application method of fertilizers, and other compounds, used in cultivation.

---

### **TIER AND RISK DESIGNATION**

The Policy provides criteria for evaluating threats to water quality for cannabis cultivation sites based on three site characteristics: proximity to water body, total disturbed area, and slope of the disturbed area. Based on the criteria and site characteristics the subject property is classified as a Tier 2, High Risk Discharger. The total disturbed area across all the parcels is 3.58 acres, all of which is located on slopes of less than 30%. See Tables 1a-c in Section 3, below.

---

### **DESCRIPTION OF CANNABIS CULTIVATION ACTIVITIES ON PARCELS**

The four parcels are used for cannabis cultivation, in addition to ranching and livestock purposes, and are discussed in detail below.

#### **“Pond” Parcel (APNs: 216-136-004, 216-135-008)**

Existing built infrastructure on this parcel includes a 24' x 60' metal building, two shipping containers, a tiny home, a portable toilet, and storage shed on a ~1,440 sf concrete slab. There are two Points of Diversion (PODs) used on this site: a spring diversion (POD-2) located on the “Quarry” parcel and diversion out of Pond 1 (POD-1). Pond 1 is an unlined onstream pond with a capacity of approximately 10 million gallons that was constructed prior to the discharger obtaining the property. The applicant is proposing to obtain an onstream Small Irrigation Use Registration in order to be able to use this pond as storage, and rainwater catchment and associated storage is proposed to be used in the interim. The pond may be modified, mitigated for, or removed, pending ongoing discussion with applicable agencies. Water usage is tracked throughout the diversion season (see Appendix C).

Prior to January 1, 2016, there was approximately an acre of sf of cultivation on this parcel in seven cultivation areas (A-G). Four of these seven areas need to be either adjusted or removed completely to comply with standard riparian buffers, as described below:

- *Area A* historically had approximately 7,000 sq. ft. of outdoor cultivation and light-deprivation cultivation in a 30' x 50' greenhouse. This greenhouse may be relocated to Area H or I due to proximity to the property boundary (boundary survey pending).
- *Area B* historically had approximately 4,000 sq. ft. of outdoor cultivation and can remain as-is.
- *Area C* historically had approximately 6,000 sq. ft. of outdoor cultivation and needs to be reduced to 2,700 sq. ft. to comply with a 50' riparian buffer off a Class III watercourse near the north side of the cultivation area.



- *Area D* historically had approximately 4,100 sq. ft. of outdoor cultivation and can remain as-is.
- *Area E* historically had approximately 2,800 sq. ft. of outdoor cultivation but is located entirely within a riparian setback from a Class III watercourse. All cultivation-related equipment will be completely removed from this area and the area will be restored with natural vegetation.
- *Area F* historically had approximately 7,500 sq. ft. of cultivation. This area is located entirely within 100' from a Class II watercourse and 50' from a Class III drainage. All cultivation-related equipment will be completely removed from this area and the area will be restored with natural vegetation.
- *Area G* historically had approximately 11,660 sq. ft. of cultivation and will be reduced to approximately 8,650 sq. ft. of cultivation (~6,400 sq. ft. in light-deprivation greenhouses) due to proximity to a Class III drainage.

Approximately 12,300 sf of cultivation from parts of Areas C, E, F, G, and potentially A will be relocated to proposed Cultivation Areas H and I (likely 6,300 sf at each site). Cultivation Area H is located on an existing road and grassy flat area with slopes less than 10% grassy flat and Cultivation Area I is located on a historic logging terrace with slopes less than 8%. Cultivation area H is located 200' from the nearest watercourse (Class III drainage) and Cultivation Area I is located over 100' from the nearest watercourse (Class II drainage). Relocating cultivation out of riparian areas will help protect and restore the quality of the area, which is beneficial for fish and wildlife habitat and well-being, human health, municipal, domestic, and agricultural water supply, and recreational purposes.

#### "Thunder" Parcel (APN: 216-135-015)

Existing built infrastructure on the "Thunder" parcel includes a 30' x 50' metal building on a ~1,500 sf concrete slab. There are no other structures located on this parcel. There is currently 27,260 gallons of water storage in plastic water tanks, and a spring point of diversion (POD-5) is located on this site. An off-stream, 800,000-gallon capacity rainwater catchment pond is proposed on this site to catch and store water for use during the forbearance period (POND-7). Water usage is tracked throughout the diversion season (see Appendix C).

Prior to January 1, 2016, there was 24,000 sf of outdoor cultivation in two separate cultivation areas: The Northern Cultivation Area and the Western Cultivation Area. Both locations were located partially within stream setbacks and will be relocated to the Central Cultivation Area.

- *Northern Cultivation Area* historically had 6,300 sf of outdoor cultivation. This site is located almost entirely within 100' of a Class II stream. As such, all cultivation and cultivation-related materials will be completely removed and relocated to the Central Cultivation Area (**CA-Northern**)
- *Western Cultivation Area* historically had 17,700 sf of outdoor cultivation. Approximately 1/3 of this cultivation area is located within 50' of a Class III drainage and will need to be removed and relocated. For consolidation and reduced impact, all 17,700 sf of cultivation is proposed to be relocated to the Central Cultivation Area (**CA-Western**). This area is located at the end of a 0.5-mile dirt/gravel road with slopes in excess of 20% and moderate erosion issues (discussed in detail in Section 1, below).
- *Central Area (Relocation Site)* is a series of benched areas with slopes less than 17%. All of the cultivation on the "Thunder" parcel is proposed to be relocated to this area. The Central Area is located on well-maintained roads and provides suitable buffers from sensitive riparian areas.



“Ranch” Parcel (APN: 216-135-013)

Existing built infrastructure on the “Ranch” parcel includes a mobile home residence, a barn, horse stables and an arena, shipping containers, a generator shed, water storage, and storage sheds. This site has three existing ponds: a 40,000-gallon capacity off-stream rainwater catchment pond (Pond 2), a 35,000-gallon capacity off-stream rainwater catchment pond (Pond 3), and an 80,000-gallon capacity onstream pond (Pond 4). This site currently has 160,000 gallons of water storage in the form of Ponds 2 and 3, interim water bladders, and plastic tanks, and an 800,000-gallon capacity off-stream rainwater catchment pond is proposed to collect and store water for use during the forbearance period (POND-5). Two surface water points of diversion, a spring diversion near Pond 3 (POD-3) and a spring near Pond 4 (POD-4), are located on this site. Water usage is tracked throughout the diversion season (see Appendix C).

10,000 square feet of outdoor cultivation exists on this site, within riparian setbacks. The 10,000 square feet of cultivation is proposed to be moved up to an existing flat. The proposed relocation area is a flat, easily accessible area located suitably away from sensitive riparian areas.

“Quarry” Parcel (APN: 216-135-010)

A spring Point of Diversion (**POD-2**) is located on this parcel. Road access to the “Pond” parcel transects this parcel and a rock quarry, unrelated to this project, is also located on this parcel. Water usage is tracked throughout the diversion season (see Appendix C).

---

**BEST PRACTICABLE TREATMENT OR CONTROL (BPTC) MEASURES**

Corrective actions that are required to meet the BPTC measures outlined in Attachment A of the Order are bolded throughout this section. Corrective actions correspond with the actions listed in Tables 3a-c on page 17.

**1. Site Maintenance, Erosion Control, and Drainage Features**

The proposed erosion BPTC prevention measures described below will be implemented in accordance with road construction standards described in the “Road Handbook”. Appropriate erosion prevention and sediment control measures will be installed, maintained, and monitored for effectiveness prior to the winter season. Road work requiring heavy machinery, such as construction or reshaping of rolling dips, shall be conducted only during the dry season. ditch relief culvert will be inspected for erosion or clogging prior to the rainy season and after a significant storm event. Any debris and sediment found to be clogging culverts, inlets/outlets, or drainageways will be removed and appropriately stored, reused, or disposed of. Appropriate BPTC measures are utilized for all stockpiled materials (including soil piles, sawdust, soil amendments, rock, compost, treated wood, polytube or other irrigation equipment, plastic sheeting, etc.) that may have the potential to migrate to surface waters or that may be hazardous to wildlife. Any stockpiled materials will be stockpiled in an upland area away from watercourses, covered, and/or stored within a structure. Refer to the BPTC specifications in Appendix B for more details on how to properly construct or install recommended BPTC Measures.

“Pond” Parcel

A 1.179-mile road network in good to fair condition spans from the Pond parcel access gate to the seven existing Cultivation Areas. A 0.3-mile segment of County-maintained Harris Road is also located in the Northwestern portion of this parcel. The graveled road network is comprised of slopes less than 15% and exceeds 14’ in width. Nine (9) rolling dips were prescribed to be installed and one (1) existing rolling dip was prescribed to be maintained (**RDs 1-10**), as shown on the maps in





Appendix A. One (1) existing ditch-relief culvert (DRC) was prescribed to be maintained (DRC-2) and two DRCs were prescribed to be installed (**DRC-1, DRC-3**). Two segments of road were prescribed to be out sloped (**OS-1, OS-2**) and a 50' segment of inboard ditch exhibiting incision was prescribed to be rocked (**IB-1**). All historically disturbed areas created for cannabis cultivation have revegetated and are stable with no areas of active erosion. As described in the accompanying Disturbed Area Stabilization Plan, any future earthwork regarding relocation of cannabis sites will use proper BPTC Measures to ensure stabilization of bare or exposed soils.

#### “Thunder” Parcel

A 1.14-mile road network in good condition exists on this parcel. The parcel has two access points: a private gate off of the County-maintained Harris Road and a continuation of the private road from the “Ranch” parcel to the South. The 240+-acre parcel has other skid roads and ranch roads that were not surveyed by NorthPoint Consulting’s engineering team as they were unrelated to the cannabis cultivation project. The County-maintained Harris Road is partially located on this parcel. The gravel road network is comprised of slopes less than 18% and exceeds 12’ in width. Ten (10) rolling dips were prescribed to be installed, one (1) existing rolling dip was prescribed to be enlarged, and two (2) existing rolling dips were prescribed to be maintained (**RDs 11-23**). One (1) existing 24”-diameter plastic DRC was prescribed maintenance to adequately function (**DRC-4**), and three (3) DRCs were proposed (**DRC-5, DRC- 6, DRC-7**) and a 200’ segment of road was prescribed to be out sloped (**OS-3**). Approximately 200’ of inboard ditch near DRC-6 and STX-14 was proposed to be rocked to reduce water velocity and prevent further ditch incision (**IB-2**). Once the square footage has been moved to the Central Area from the Northern Area, the segment of road leading to the Northern area is proposed to be decommissioned. Road decommissioning will occur in compliance with recommendations from the *Handbook for Forest, Ranch and Rural Roads* created by Pacific Watershed Associates (“Road Handbook”). All historically disturbed areas created for cannabis cultivation have revegetated and are stable with no areas of active erosion.

#### “Ranch” Parcel

A 0.68-mile road network in good condition exists on this parcel. The parcel is accessed from either a gate off of the county-maintained Harris Road, or a continuation of the private road from the “Thunder” parcel to the North. The 0.68-mile road network has slopes of less than 15% and exceeds 12’ in width. The road is graveled and in excellent condition with few signs of erosion. One (1) rolling dip was prescribed to be installed (**RD-24**). All historically disturbed areas created for cannabis cultivation have revegetated or have been seeded and strawed.

## **2. Stream Crossing Maintenance**

There are sixteen (16) stream crossings on the parcels located on privately maintained road networks, ten (10) of which were considered “Projects” and submitted to the California Department of Fish and Wildlife (CDFW) in a Streambed Alteration Notification. The Streambed Alteration Agreement has been finalized and assigned number #1600-2018-0422-R1. Of the ten projects, four (4) lack engineered crossings, four (4) require replacement of existing culverts, one (1) culvert is proposed to be removed, and one (1) is an appropriate stream crossing that only requires maintenance. Stream Crossings 1-5 and 13 are on the “Pond” parcel, Stream Crossings 9, 14, and 15 are on the “Thunder” parcel, and Stream Crossing 6 is on the “Ranch” parcel. The ten crossings that require corrective action are bolded and included in Tables 2a-c.

#### “Pond” Parcel (STXs 1-5, 10-13)

Stream Crossing 1 (**STX-1**) is an existing 18” corrugated metal pipe (CMP) located where a Class II seasonal drainage crosses a dormant, dead-end road. The crossing drains ~23 acres of hillslope. The inlet of the culvert is plugged, causing water to run across the road and erode the road around the



culvert outlet. In addition, the culvert has significant rust and structural issues. The property owner does not plan to use this road anymore and therefore proposes to remove the culvert and re-establish the drainage channel. The stream channel will be re-contoured to its natural slope and width (approximately 3' wide) and riparian vegetation consistent with the surrounding vegetation will be planted to help stabilize exposed soil.

Stream Crossing 2 (**STX-2**) is located where a Class III drainage (watershed area 1.5 acres) intersects the access road to Cultivation Areas F and G. There is currently no engineered crossing. The applicant proposes to install a 24"-diameter CMP to adequately drain peak flows during the 100-year storm event. A rolling dip is proposed 50' up-road of the crossing to help disperse surface flow (as shown on the map in Appendix A).

Stream Crossing 3 (**STX-3**) is an existing 24"-diameter CMP located where a Class II drainage intersects the access road to a Cultivation Area G. The culvert drains a watershed area of ~26 acres and has a shotgun outlet that is causing erosion of the access road in addition to being undersized. The culvert is also placed too high in the road prism and is not on stream-grade, with only 5" of road cover on the outlet. The applicant proposes to remove the existing culvert and replace it with a 33"-diameter CMP on-grade with the stream channel. A critical dip is proposed 5' from the crossing.

Stream Crossing 4 (**STX-4**) is an existing 12"-diameter corrugated plastic culvert located where a Class II drainage (watershed area 17 acres) crosses the road to all cultivation areas. Approximately 100' of incising inboard ditch delivers water and sediment to the culvert. The culvert is undersized with a small shotgun outlet and erosion on the downstream end. The applicant proposes to remove the undersized culvert and replace it with a 33" diameter CMP installed on-grade with the stream channel. A ditch relief culvert is proposed approximately 50' up road (west) of the culvert inlet to help reduce sedimentation and disperse flows (**DRC-1**).

Stream Crossing 5 (**STX-5**) is an existing rusted-out 24"-diameter CMP located where the access road to the Pond parcels crosses over a Class III drainage. The culvert drains ~13 acres of hillslope. Erosion of the road prism and a shotgun outlet is visible. The applicant proposes to replace the non-functional culvert with a 33"-diameter CMP. A ditch relief culvert is proposed 50' up road of the culvert inlet to help reduce inboard ditch incision (**DRC-3**). A critical dip is also proposed.

Stream Crossings 10, 11, and 12 (STXs 10-12) are three crossings located where ephemeral drainages run under the Pond 1 berm/perimeter road and into the pond on the "Pond" parcel. Each culvert is an 18"-diameter CMP with rust lines below 16%. They were installed prior to 2004 when Pond 1 was constructed and were therefore installed prior to the formation of the lake or Streambed Alteration Program. STX-10 has a contributing drainage area of 21.7 acres. Although this watershed area is large, the area is comprised of mostly flat meadowlands, allowing water to infiltrate into the soils prior to channelizing in a .5'-wide channel and reaching the drainage. STX-11 has a contributing watershed area of 7.1 with a drainage channel of 0.25', and STX-12 has a watershed area of 7.46 acres with a drainage channel of .5'. All three culverts are functioning adequately and have no structural issues. No corrective actions were recommended.

Stream Crossing 13 (**STX-13**) is located where a small seep crosses the access road to all cultivation sites. The seep comes from a 5'-wide legacy cattle pond that has formed a small 0.5'-diameter channel, which runs across the road and down the slope on the other side. The culvert has a small contributing watershed area of 1.75 acres. Due to the small size and ephemeral nature of the drainage, the applicant proposes to install a rocked dip.

#### "Thunder" Parcel (STXs 7-9, 14-16)

Stream Crossing 7 (STX-7) is an existing 48"-diameter culvert located on a dormant road on the "Thunder" Parcel. The culvert, which was installed in 2002, is in good condition and has a 14% rust



line. No work is proposed for this crossing. Since the culvert is adequately draining the hillslope and is in good condition, no corrective actions were proposed.

Stream Crossing 8 (STX-8) is an existing 48"-diameter culvert located on a dormant road on the "Thunder" Parcel near the Northern Cultivation Area (to be relocated). The culvert has a 45% rust line, is clearly undersized, and needs replacement, but is covered under the neighbor's Streambed Alteration Agreement. No corrective actions related to this discharger were proposed.

Stream Crossing 9 (**STX-9**) is located where a small Class III ephemeral drainage (watershed area 5 acres) would naturally cross the road to connect with the downstream channel. The drainage is currently ditched down the road via an inboard ditch and then runs onto the road, contributing to road erosion. To mitigate sediment transport and erosion, the applicant proposes to install a rocked crossing to connect the upstream and downstream channels. A rocked crossing will be sufficient because the applicant is not intending to use this road during winter months. Additionally, the cultivation area at the end of the road is proposed to be relocated.

Stream Crossing 14 (**STX-14**) is located where a Class III ephemeral drainage (watershed area of 4.35 acres) would naturally cross a property access road. Currently, the drainage is ditched along the road and, along with the inboard ditch above, is contributing to approximately 4.5' of ditch incision. To address the incision and road erosion, the applicant proposes to re-connect the upstream drainage channel with the lower drainage channel via a 24"-diameter CMP, set to grade as feasible. The inboard ditch is proposed to be blocked just down road from the proposed culvert after installation so that flow is directed through the culvert and not down the ditch. This project should alleviate the majority of the incision problems occurring on this stretch of road and will help to reduce sedimentation and road prism erosion.

Stream Crossing 15 (**STX-15**) is an existing rocked crossing located where an ephemeral drainage crosses the road to a proposed cultivation site. The existing rocked crossing (watershed area 3.64) is well armored, properly constructed, appears to be adequately draining the small drainage. The applicant proposes to maintain this crossing, as the road will not be used during the wet season.

Stream Crossing 16 (STX-16) is an approximately 5'-wide channel bed of a seasonal drainage that crosses a dormant gravel road. The crossing has a contributing watershed area of 98.8 acres and the streambed runs dry every summer. There is currently no engineered crossing, but no signs of erosion or sedimentation were observed on-site. As the applicant does not use this road at all during the winter (and rarely in the summer), the applicant proposes to leave this crossing as-is. No corrective actions were proposed.

#### "Ranch" Parcel (STX-6)

Stream Crossing 6 (**STX-6**) is an existing 48"-diameter CMP located where a cultivation access road crosses over a Class II stream. The existing culvert drains ~40 acres of hillslope and is partially rusted out the bottom. The applicant proposes to remove this culvert and replace it with a 48"-diameter CMP on-grade with the stream channel.

All stream crossings will be constructed in conformance with the conditions of the Streambed Alteration Agreement, as well as best practices from the *Handbook for Forest, Ranch and Rural Roads*<sup>7</sup>. All stream crossing improvements will be conducted during the driest part of the year when no water is present in the watercourses.

### **3. Riparian and Wetland Protection and Management**

---

<sup>7</sup> <http://www.pacificwatershed.com/sites/default/files/RoadsEnglishBOOKapril2015b.pdf>



All of the parcels have at least one historic cultivation area located within watercourse setbacks. All cultivation areas and associated facilities are proposed to be adjusted or removed (as described above and in Tables 2a-c) in order to meet standard riparian buffers (minimum 50' from Class III watercourse, 100' from Class II watercourse, and 150' from Class I watercourse). Areas out of compliance with buffers are italicized in Tables 1a-1c, below.

<b>Table 1a: Disturbed Area Distance to Water Body and Slope APN 216-136-004 / 216-135-008 (Pond)</b>				
Disturbed Area Type	Area (sq. ft.)	Disturbed Area Slope	Distance to Water Body (ft.)	Water Body Type
Outdoor Cultivation A, Water Tank (1,100-gal.)	5,500	10.2%	250	Class III Drainage
Light-dep Greenhouse	1,500	12.5%	248	Class III Drainage
Storage Shed	112	4.4%	282	Class III Drainage
Drying Shed	683	6.1%	230	Class III Drainage
Drying Building	1,588	5.1%	58	Class III Drainage
Shipping Container 1	200	6.3%	128	Class III Drainage
Shipping Container 2	200	6.3%	124	Class III Drainage
Outdoor Cultivation B, 550-gal. Water Tank	4,000	10.9%	80	Class III Drainage
<i>Outdoor Cultivation C, Water Tanks ([1] x 1,000-gal., [1] x 2,500-gal.) – to be relocated</i>	<i>6,000 → 2,700</i>	<i>10.4%</i>	<i>25</i>	<i>Class III Drainage</i>
Outdoor Cultivation D, 1,100-gal. Water Tank	4,100	12.1%	82	Class III Drainage
<i>Outdoor Cultivation E, 550-gal. Water Tank – to be relocated</i>	<i>2,800 → 0</i>	<i>6.8%</i>	<i>40</i>	<i>Class III Drainage</i>
<i>Outdoor Cultivation F, Water Tanks ([1] x 1,100-gal., [1] x 2,500-gal.) – to be relocated</i>	<i>7,500 → 0</i>	<i>15.6%</i>	<i>0/40</i>	<i>Seep / Class III Drainage</i>
<i>Outdoor Cultivation G, Water Tanks ([1] x 550-gal., [1] x 1,100-gal.) – to be adjusted</i>	<i>11,660 → 8,650</i>	<i>11.4%</i>	<i>22</i>	<i>Class III Drainage</i>
Cultivation Area H (Proposed – not included in D.A.)	~6,300	5%	200'	Class III Drainage
Cultivation Area I (Proposed – not included in D.A.)	~6,300	8%	100'	Class II Drainage
Off-stream Rainwater Catchment Pond (Proposed – not included in D.A.)	25,000	5-8%	100'	Wetland / Seepy Area
<b>Total Existing Disturbed Area</b>	<b>45,843 sq. ft.</b>			

<b>Table 1b: Disturbed Area Distance to Water Body and Slope APN 216-135-015 (Thunder)</b>				
Disturbed Area Type	Area (sq. ft.)	Disturbed Area Slope	Distance to Water Body (ft.)	Water Body Type
<i>Western Cultivation Area, Water Tanks ([3] x 5,000-gal., [2] x 1,300-gal., [1] x 660-gal.) on graded flat – to be relocated</i>	<i>17,700</i>	<i>8.7%</i>	<i>25</i>	<i>Class III Drainage</i>



<i>Northern Cultivation Area Water Tanks ([1] x 2,800-gal., [2] x 500-gal.) – to be relocated</i>	6,300	7.9%	15	Class II Stream
5,000-gal. Water Tank	25	6%	101	Class II Drainage
3,000-gal. Water Tank	25	4%	72	Class III Drainage
Drying Building	1,500	12.6%	630	Class II Drainage
Cultivation Greenhouses (Proposed – not included in D.A.)	24,000	11.5%	199	Class III Drainage
Proposed Off-stream Rainwater Catchment Pond 7 (Proposed- not included in D.A.)	15,000	14.6%	621	Class II Drainage
<b>Total Existing Disturbed Area</b>	<b>25,550 sq. ft.</b>			

<b>Table 1c: Disturbed Area Distance to Water Body and Slope Disturbed Areas on APN 216-081-013 (Ranch)</b>				
Disturbed Area Type	Area (sq. ft.)	Disturbed Area Slope	Distance to Water Body (ft.)	Water Body Type
Graded Flat for Proposed Cultivation and Immature Plant Greenhouses	60,719	8.1%	135	Class II Drainage
Pre-Existing Outdoor Cultivation	2,250	13.7%	108	Class III Drainage
<i>Existing Cultivation – to be relocated</i>	<i>10,000</i>	<i>5%</i>	<i>20</i>	<i>Class II Drainage</i>
Storage Shed	125	2.7%	458	Class III Drainage
2 x Storage Shipping Containers	747	2.7%	450	Class III Drainage
20' x 20' Generator Shed	400	8.1%	120	Class II Drainage
10K-gal. Lower Bladder	2,500	4.1%	20 / 100	Pond overflow / Class II Drainage
Upper Bladder ([3] x 20K-gal., [1] x 10K-gal.)	8,400	16.5%	188	Class III Drainage
(2) x 2,500-gal. water tanks	25	4%	100	Class II Drainage
Rainwater Catchment Pond 5 (Proposed – not included in D.A.)	18,000	6%	50'	Class III drainage and legacy cattle Pond 4
<b>Total Existing Disturbed Area</b>	<b>85,176 sq. ft.</b>			

The existing disturbed area across all of the sites described above totals 156,159 sq. ft. For all other sites and facilities, riparian buffers from cultivation areas and associated facilities shall be maintained with a natural slope and native vegetation and have sufficient width to filter any runoff from the cultivation site into the stream. All riparian areas shall be protected to maintain their essential functions, such as temperature and groundwater recharge, and to safeguard water quality.

#### 4. Spoils Management

There are numerous soil piles existing across the three parcels. On the Pond Parcel, a soils pile is located near Cultivation Area A, well away from surface waters. On the “Thunder” Parcel, a soil pile near the Western Cultivation Area is located within 50’ of a Class III stream and needs to be relocated outside of riparian buffers (**SP-1**). Soils pile on the ranch are stored within shipping containers. Prior to the rainy season, all spoils piles must be securely tarped, and straw waddles will be installed around the pile to prevent sediment mobilization and potential delivery to surface waters (**WZ**).



## **5. Irrigation Runoff**

No evidence of water movement and erosion in the cultivation areas was observed during the inventory. Erosion and sediment control BPTCs will be installed to inhibit runoff from the landings reaching the riparian zone. To further prevent connectivity, the owner will:

- implement water conservation measures;
- irrigate at agronomic rates;
- apply fertilizers/chemicals according to label specifications;
- maintain stable vegetated buffer between cultivation area and riparian zone; and
- install water, erosion, and sediment BPTCs as required.

As per the Standard Conditions and Attachment A of the Order, after adjustment and restoration of Cultivation Areas C, E, F, and on the Pond parcel, Cultivation Areas Western and Northern on the Thunder parcel, and all new cultivation on the Ranch parcel, cultivation areas and associated facilities will be not be located or occur within 150 ft of any Class I watercourse, 100 ft of any Class II watercourse or wetlands, or within 50 ft of any class III watercourse.

## **6. Fertilizer and Soil Amendments**

Journey Aquarian utilizes the following fertilizers/ soil amendments for cultivation: Dr. Earth All-Purpose Fertilizer, Chicken Manure, Azomite, Diatomaceous earth, Calcium Phosphate Tribasic, Earth Juice Rainbow Mix Grow, Green Gro Nature's Pride Veg, Age Old Bloom, Age Old Gro, Soluble Humic Acid, Max Sea Seaweed Plant Food, and Max Sea Plant Food. Fertilizers are stored within wooden storage sheds and shipping containers when not in use, specifically in the barn or in shipping containers on the "Ranch" parcel, within a shed near the building flat on the "Pond" parcel, and within the metal building on the "Thunder" parcel. These storage locations are located away from riparian areas where soils will not contaminate waterways. The accompanying Nitrogen Management Plan contains more detailed data regarding amounts of fertilizers applied and data sheets to record fertilizer usage.

All liquid products are stored within secondary containment to prevent leachate or spills from entering surface waters. Fertilizer mixing on the "Ranch" occurs in the back end of the nursery greenhouse using an automatic mixer. On "Thunder" and "Pond" parcels, fertilizer mixing happens manually adjacent to each cultivation area in dedicated mixing tanks. Appropriate BPTC measures will be utilized when storing, handling, mixing, applying, and disposing of all fertilizers or pesticides. Fertilizer mix is applied to plants on all parcels using an automated drip emitter. Drip emitters are set up to automatically and efficiently irrigate and fertigate plants such that no or minimal runoff occurs. Inventory of products occurs periodically throughout the growing season, and necessary products are delivered to the site as needed.

Journey Aquarian utilizes Neem Oil as a fungicide, pesticide, and insecticide. Occasionally, Green Cleaner is also used. Pesticides are currently being stored within the storage sheds denoted on the map (though in containers separate from the fertilizers), where they cannot contaminate waterways. The cultivator applies and uses fertilizers/soil amendments/pesticides at proper agronomic rates per packaging instructions. Application rates are tracked and reported as required by the Order.

Trash and recycling from cannabis operations onsite is quickly removed from the property. Trash and recycling, including empty soil and fertilizer bags, liquid fertilizer bottles, pesticide containers, and other cultivation-related waste, are taken to the recycling center in Garberville as-needed (generally once a month during the off-peak season and weekly during peak season). The discharger takes great care with liquid products and ensures secondary containment is in place to hold any spills or drips on bottles.



## **7. Petroleum Product and other Chemicals**

Journey Aquarian utilizes generators for onsite power, though proposes to connect cultivation activities to the PG&E grid. On the Ranch parcel, a “Whisperwatt” generator is used to power cultivation activities. The Whisperwatt generator is located within a permanent generator shed, complete with a roof and a spill pan. A spill kit is kept in the shed for use in the event of a petroleum spill. Petroleum to fuel the generator on the Ranch is located in the shed near the generator shed. On the Thunder parcel, a generator is also kept within a generator shed. Other portable generators are mobile and are moved throughout the duration of the season depending on cultivation needs. Journey Aquarian will ensure that generators are located in secondary containment when used in the field on the “Pond” and “Thunder” parcels (**SC-1, SC-3**). When not being used, generators are stored in shipping containers or wooden sheds. Gasoline is also stored in sheds and shipping containers. Prior to the winter, any machines or equipment with petroleum products will be stored out of the elements (e.g. under a carport) where potential leaks will not enter surface waters. Any waste from cultivation or spent petroleum products are regularly removed from the site.

## **8. Cultivation and Waste**

Vegetation matter such as branches and leaves are composted and are stored near Cultivation Area A on the Pond parcel, Proposed Pond 7 on the Thunder parcel, and near the proposed cultivation relocation area on the Ranch parcel. All packaging from soil amendments and fertilizers will be collected and disposed at an appropriate facility.

## **9. Refuse and Human Waste**

The Pond and Thunder parcels have no permanent residences onsite. Workers use portable toilets. The septic system located in the break area on the “Pond” parcel and within the residence on the “Ranch” parcel are proposed to be permitted. When in use, the toilets are serviced based on recommended frequencies. All the parcels are clean and generally free of garbage. Garbage on the Pond and Thunder parcels is temporarily stored in shipping containers, where it is prevented from polluting surface waters and is not accessible to wildlife. Journey Aquarian makes bi-weekly trips (or as needed, depending on the time of season) to the Recology Waste Management Center in Garberville to properly dispose of waste.

## **10. Monitoring**

As outlined in Attachment B of the Order, all high risk sites are required to perform additional monitoring, including Surface Water Runoff monitoring, Soil Erosion Control monitoring, Sediment Capture monitoring, Erosion/Sediment Capture Maintenance, Stabilization of Disturbed Areas, Material (s) Storage Erosion and Spills Prevention Monitoring and Holding Tank/Septic Tank/Servicing as described in Table 2. Specifically, the existing and proposed ditch culverts will be monitored regularly for plugging. Inboard ditches will be examined for incision and/or sediment buildup. Any removed sediment will be reintegrated appropriately onsite in accordance with the order. There are no existing bare soils areas or bare cutbank slopes that require monitoring or revegetation, though once cultivation relocation occurs, the restored areas will be monitored for regrowth and erosion. In addition, winterization measures that are implemented will be monitored for effectiveness (inspected during the first major winter storm event) before the site is closed for the winter. If winterization measures are not able to be completed before the wet season begins, Storm Water Runoff Monitoring (see Table 2) will be implemented to record pH and turbidity levels at designated points of disturbed areas within riparian setbacks (see the accompanying Disturbed Area Stabilization Plan).



<b>Table 2. BPTC Effectiveness Monitoring and Reporting Requirements</b>			
Monitoring Requirements	Description	Specific BPTC Measure	Monitoring Frequency
<b>Winterization Measures Implemented</b>	Report winterization procedures implemented, any outstanding measures, and the schedule for completion.	Soil Winter Pile Winterization	October - May
<b>Tier Status Confirmation/ Third Party Identification</b>	Report any change in the tier status. (Stabilization of disturbed areas may change the tier status of a facility. Contact the Regional Water Board if a change in status is appropriate).		Annually
<b>Active Erosion or Sediment Control Areas</b>	Observe areas of active erosion or sedimentation for signs of improvement.	None Specified	Monthly
<b>Nitrogen Application</b>	Report monthly and annual total nitrogen use for bulk, solid, and liquid forms of Nitrogen	n/a	Monthly
<b>Surface Water Runoff</b>	Monitor storm water runoff locations for pH and Turbidity once per calendar month when the precipitation exceeds 0.25 inches/day or when storm water runoff from the site is generated.	All winterization measures	As specified prior to completed winterization measures
<b>Soil Erosion Control</b>	Report and monitor any indications of soil erosion (gulying, turbid water discharge, landslide, etc.	n/a	Monthly
<b>Sediment Capture</b>	Report and monitor all sediment capture measure (fiber rolls)	n/a	Monthly
<b>Erosion/Sediment Capture Maintenance</b>	Report maintenance activities to maintain the effectiveness of erosion control and sediment capture measures (e.g. reapplication of straw, tarp placement, removal or stabilization of sediment captured, etc.)	n/a	Monthly
<b>Stabilization of Disturbed Areas</b>	Report describing activities performed to stabilize the disturbed area within the setback	n/a	Monthly – not expected to occur until post-permit approval
<b>Material Storage / Spill Prevention</b>	Report fertilizers, potting soil, manure, chemicals, gasoline, etc.	n/a	Monthly
<b>Chemical Toilet Servicing</b>	Record servicing of onsite portable toilets, as needed	Portable Toilets	Monthly

## 11. Reporting

Journey Aquarian will report the above required information in the Annual Report due annually by March 1<sup>st</sup> of the following year being monitoring.





**Table 3a: Corrective Actions identified for Journey Aquarian’s “Pond” Parcel (APNs: 216-136-004 / 216-135-008)**

Note: This table was created along with the WRP

P. Current Conditions have not been updated and were accurate from fall 2018. The BPTC Time Schedule (in red) has been updated to reflect current site conditions and completed corrective actions have been noted.

Map ID	Description	Current Condition	Corrective Action	Priority for Action (1 = High)	BPTC Time Schedule (Updated Sep 2019)
CA-1	Cultivation Adjustment: Area C	Cultivation Area C has ~6,000 sf of outdoor cultivation, 3,300 sf of which is located within 50’ of a Class III drainage	Remove the 3,300 sf of cultivation to establish a 50’ riparian buffer from the Class III drainage, leaving ~2,700 sf of cultivation at Cultivation Area C; Relocate cultivation to Area H or I	2	After County Approval
CA-2	Cultivation Area Adjustment: Area E	Cultivation Area E has ~2,800 sf of outdoor cultivation located entirely within a riparian setback from a Class III watercourse	Remove all cultivation and cultivation-related equipment from this site; restore with natural vegetation; relocate cultivation to Area H or I	2	After County Approval
CA-3	Cultivation Area Adjustment: Area F	Cultivation Area F has ~7,500 sf of cultivation located entirely within the riparian buffers of a Class III watercourse and a Class II stream.	Remove all cultivation and cultivation-related equipment from this site; restore with natural vegetation; relocate cultivation to Area H or I	2	After County Approval
CA-4	Cultivation Area Adjustment: Area G	Cultivation Area G has ~11,660 sf of cultivation, ~1,000 sf of which is located within 50’ of a Class III drainage.	Remove all cultivation within 50’ buffer of watercourse (~1,000 sf) and relocate to Area H or Area I	2	After County Approval
DRC-1	Ditch Relief Culvert 50’ up road of STX-4	Inboard ditch that feeds STX-4 is incising and has the potential to deliver sediment to the crossing	Install 18” ditch relief culvert 50’ up road of STX-4 to alleviate volume on STX-4 and break up the inboard ditch to minimize erosion	1	Prior to October 2020

**Table 3a: Corrective Actions identified for Journey Aquarian’s “Pond” Parcel (APNs: 216-136-004 / 216-135-008)**

Note: This table was created along with the WRP

P. Current Conditions have not been updated and were accurate from fall 2018. The BPTC Time Schedule (in red) has been updated to reflect current site conditions and completed corrective actions have been noted.

Map ID	Description	Current Condition	Corrective Action	Priority for Action (1 = High)	BPTC Time Schedule (Updated Sep 2019)
DRC-3	Ditch Relief Culvert 50’ up road of STX-5	Inboard ditch that feeds STX-5 is incising and has the potential to deliver sediment to the crossing	Install 18” ditch relief culvert 50’ up road of STX-5 to alleviate volume on STX-5 and break up the inboard ditch to minimize erosion	1	Prior to October 2020
IB-1	Inboard Ditch near proposed Cultivation Area H	Existing inboard ditch is incising and has the potential to deliver sediment to a Class III drainage located approximately ~25’ west	Rock incised ditch for 50’ down road from proposed rolling dip	2	Completed; ongoing
OS-1	Out slope segment of road	Existing road surface is exhibiting rilling	Out slope 110’ of road as indicated on the map	2	Prior to October 2020
OS-2	Out slope segment of road	Existing road surface is exhibiting rilling and minor erosion	Out slope 100’ of road as indicated on the map	2	Prior to October 2020
RDs 1-10	Rolling Dips throughout parcel	Road points along the 1.18-mile road network currently lack water drainage features and have the potential to erode without corrective action	Install rolling dips where noted on the map	1	Completed; ongoing maintenance

**Table 3a: Corrective Actions identified for Journey Aquarian’s “Pond” Parcel (APNs: 216-136-004 / 216-135-008)**

Note: This table was created along with the WRP

P. Current Conditions have not been updated and were accurate from fall 2018. The BPTC Time Schedule (in red) has been updated to reflect current site conditions and completed corrective actions have been noted.

Map ID	Description	Current Condition	Corrective Action	Priority for Action (1 = High)	BPTC Time Schedule (Updated Sep 2019)
SC-1	Secondary Containment: Generators while in field	Generators are currently used in the field (near cultivation and water storage areas), some without secondary containment	Purchase plastic tubs with tops or other impermeable containers for generators and ensure use in field	1	Completed; ongoing assurance of secondary containment
SC-2	Secondary containment: Fuel in storage sheds	Gasoline and other petroleum products are stored in a wooden shed without secondary containment	Purchase plastic tubs or other impermeable containers for fuels stored in shed	1	Completed; ongoing assurance of secondary containment
STX-1	Stream Crossing 1 (40.105414°, -123.647611°)	Malfunctioning 18” CMP on Class II drainage is plugged and is exhibiting structural issues, causing to erosion of the dormant road	Remove existing culvert and dormant road; Re-establish the drainage channel by re-contouring to natural slope and width; Seed and plant riparian vegetation to help stabilize soil and restore watercourse.	2	After DFW & RWB 401 approval; Prior to October 2020
STX-2	Stream Crossing 2 (40.103138°, -123.647549°)	No existing engineered crossing for Class III drainage intersecting cultivation access road; road is exhibiting signs of erosion near outlet	Install a 24” CMP to adequately drain peak flows and road erosion	1	After DFW & RWB 401 approval; Prior to October 2020
STX-3	Stream Crossing 3 (40.102572°, -123.648332°)	Existing 24” CMP has a shotgun outlet and is undersized; road is exhibiting signs of erosion near culvert outlet	Remove existing culvert and replace with 33” CMP on grade with stream channel; Install critical dip 5’ from crossing	1	After DFW & RWB 401 approval; Prior to October 2020

**Table 3a: Corrective Actions identified for Journey Aquarian’s “Pond” Parcel (APNs: 216-136-004 / 216-135-008)**

Note: This table was created along with the WRP

P. Current Conditions have not been updated and were accurate from fall 2018. The BPTC Time Schedule (in red) has been updated to reflect current site conditions and completed corrective actions have been noted.

Map ID	Description	Current Condition	Corrective Action	Priority for Action (1 = High)	BPTC Time Schedule (Updated Sep 2019)
STX-4	Stream Crossing 4 (40.103440°, -123.649937°)	Existing 12” CPP is undersized and has a shotgun outlet; road is exhibiting erosion.	Remove existing culvert and replace with 33” CMP on grade with stream channel	1	After DFW & RWB 401 approval; Prior to October 2020
STX-5	Stream Crossing 5 (40.105015°, -123.656112°)	Existing 24” CMP is rusted out and is structurally inadequate	Remove existing culvert and replace with 33” CMP; Install critical dip 5’ from crossing	1	After DFW & RWB 401 approval; Prior to October 2020
STX-13	Stream Crossing 13 (40.103035°, -123.651628°)	No existing engineered crossing	Install rocked dip to adequately drain the small, ephemeral seep	2	After DFW & RWB 401 approval; Prior to October 2020
WM	Water Meters at Points of Diversion	Diversion amounts are not properly metered	Purchase and install water meters on all sources of water (POD-1, POD-2) in a manner that records water use and type (i.e. separate out domestic water from irrigation water)	1	Completed
WZ	Winterization Measure: Soil Pile Stabilization	Soil piles are not fully tarped	Tarp under and around all soils piles, install erosion and sediment control BMPs (such as straw waddles around piles) prior to winterization	1	Completed

**Table 3b: Corrective Actions identified for Journey Aquarian’s “Thunder” Parcel (APNs: 216-135-015)**

Map ID	Description	Current Condition	Corrective Action	Priority for Action (1 = High)	BPTC Time Schedule (Updated Sep 2019)
CA-Northern	Cultivation Adjustment: Northern Area	Northern Cultivation Area has ~6,300 sf of outdoor cultivation located almost entirely within 100’ of Class II creek	Remove all cultivation and cultivation-related equipment from this area; restore with natural vegetation; relocate cultivation to Southern Cultivation Area	2	After County Approval
CA-Western	Cultivation Area Adjustment: Western Area	Western Cultivation Area has ~16,000 sf of outdoor cultivation (historically 17,700), approximately 1/3 of which is located within 50’ of Class III drainage	Remove all cultivation and cultivation-related equipment from this area; restore with natural vegetation; relocate cultivation to Southern Cultivation Area	2	After County Approval
DRC-4	Existing Ditch Relief Culvert	Existing 24” CPP is plugged and not adequately draining severely incised inboard ditch	Clean debris from inlet and remove built-up sediment from outlet of CPP; maintain and inspect regularly	1	Completed; Ongoing monitoring
DRC-5	Proposed Ditch Relief Culvert 120’ up road of DRC-4	Inboard ditch is severely incised (nearly 4’ deep) and has the potential to deliver sediment to nearby watercourses	Install 18” CMP to help break up inboard ditch and reduce erosion	1	Prior to October 2020
DRC-6	Proposed Ditch Relief Culvert 50’ up road of STX-14	Inboard ditch that feeds STX-14 is severely incising and has the potential to deliver sediment to the crossing	Install 18” CMP 50’ up road of STX-14 to alleviate volume on STX-14 and reduce erosion	1	Prior to October 2020
DRC-7	Proposed Ditch Relief Culvert 120’ up road of DRC-6	Inboard ditch that feeds proposed DRC-6 is severely incised	Install 18” CMP to help break up inboard ditch and reduce erosion	1	Prior to October 2020

**Table 3b: Corrective Actions identified for Journey Aquarian’s “Thunder” Parcel (APNs: 216-135-015)**

Map ID	Description	Current Condition	Corrective Action	Priority for Action (1 = High)	BPTC Time Schedule (Updated Sep 2019)
IB-2	Inboard Ditch near STX-14	250’ of an existing inboard ditch is severely incising	Rock incised ditch for 250’ between DRC-4 and DRC-6 to help prevent further ditch incision	2	Completed in 2018; ongoing maintenance
POD-5	Diversion from Spring	Existing intake pipe of spring diversion is not screened	Install less than 3/32” screen on intake pipe to prevent aquatic life from entering the diversion works	1	Completed; ongoing maintenance
POND-7	Construction of proposed new pond	This parcel currently lacks enough water storage to be able to irrigate through the forbearance period	Construct ~800,000-gallon capacity off-stream rainwater catchment pond to collect and store water for use during the forbearance period	1	After County/DFW approval
RDs 11-23	Rolling Dips throughout parcel	Road points along the 1.14-mile road network currently lack water drainage features and have the potential to erode without corrective action	Install or maintain rolling dips where noted on the map	1	Completed in 2019; ongoing maintenance
SC-3	Secondary Containment: Generators while in field	Multiple generators are currently used in the field (near cultivation and water storage areas) without secondary containment	Purchase plastic tubs with tops or other impermeable containers for generators and ensure use in field	1	Completed; ongoing assurance of secondary containment
SP-1	Soil Pile Relocation	Existing soil pile is uncovered and is located within 50’ of a Class III watercourse	Remove all soil and soil remains from this area and relocate to an area outside of riparian buffer zones; tarp soils prior to winter season	1	Completed

**Table 3b: Corrective Actions identified for Journey Aquarian’s “Thunder” Parcel (APNs: 216-135-015)**

Map ID	Description	Current Condition	Corrective Action	Priority for Action (1 = High)	BPTC Time Schedule (Updated Sep 2019)
STX-9	Stream Crossing 9 (40.097342°, -123.670456°)	No existing engineered crossing for Class III drainage intersecting gravel road; watercourse is currently diverted down inboard ditch and is causing erosion	Install a rocked crossing to realign the upstream and downstream channels	2	After DFW & RWB 401 approval; Prior to October 2020
STX-14	Stream Crossing 14 (40.096911°, -123.663965°)	No existing engineered crossing for class III drainage intersecting steep cultivation access road; watercourse is currently diverted down inboard ditch and is causing extreme incision	Install 24” CMP on grade as feasible to reconnect upstream and downstream channels; plug inboard ditch just down road of culvert inlet	1	After DFW & RWB 401 approval; Prior to October 2020
WM	Water Meters at Points of Diversion	Diversion amounts are not properly metered	Purchase and install water meters on all sources of water (POD-5) in a manner that records water use and type (i.e. separate out domestic water from irrigation water)	1	Completed
WZ	Winterization Measure: Soil Pile Stabilization	Soil piles are not fully tarped	Tarp under and around all soils piles, install erosion and sediment control BMPs (such as straw waddles around piles) prior to winterization	1	Completed

**Table 3c: Corrective Actions identified for Journey Aquarian’s “Ranch” Parcel (APNs: 216-181-013)**

Map ID	Description	Current Condition	Corrective Action	Priority for Action (1 = High)	BPTC Time Schedule (Updated Sep 2019)
CA-Ranch	Cultivation Adjustment: Ranch Cultivation	10,000 sf of cultivation is located within 100’ of a Class II stream	Remove all cultivation and cultivation-related equipment from this area; restore with natural vegetation; relocate cultivation to graded flat above residence	1	After County Approval
CB-1	Cutbank Slope on recently graded flat	Existing ~20’ high cutbank slope is not well compacted and is exhibiting gullying and erosion with the potential to deliver sediment to a Class II watercourse	Install erosion control fabric to reduce potential of sediment delivery to surface water prior to rainy season; straw and seed as described in BMPs	1	Completed; ongoing maintenance and monitoring
CB-2	Cutbank slope on recently graded flat	Existing cutbank slope is not well compacted and could deliver sediment to Pond 2	Install erosion control fabric to reduce potential of sediment delivery to surface water prior to rainy season	1	Completed; ongoing maintenance and monitoring
POD-3	Point of Diversion 3: Diversion from Spring	Existing intake pipe of spring diversion is not screened	Install less than 3/32” screen on intake pipe to prevent aquatic life from entering the diversion works	1	Completed; ongoing maintenance
POD-4	Point of Diversion 4: Diversion from Spring	Existing intake pipe of spring diversion is not screened	Install less than 3/32” screen on intake pipe to prevent aquatic life from entering the diversion works	1	Completed; ongoing maintenance
POND-5	Construction of Proposed Pond 5	This parcel currently lacks enough water storage to be able to irrigate through the forbearance period	Construct ~800,000-gallon capacity off-stream rainwater catchment pond to collect and store water for use during the forbearance period	1	After County/DFW approval; Prior to October 2021



**Table 3c: Corrective Actions identified for Journey Aquarian’s “Ranch” Parcel (APNs: 216-181-013)**

<b>Map ID</b>	<b>Description</b>	<b>Current Condition</b>	<b>Corrective Action</b>	<b>Priority for Action (1 = High)</b>	<b>BPTC Time Schedule (Updated Sep 2019)</b>
RD-24	Rolling Dip on Access Road	One road point along the 0.68-mile road network currently lacks water drainage features and has the potential to erode without corrective action	Install rolling dip where noted on the map	1	Completed; ongoing maintenance
STX-6	Stream Crossing 6 (40.091847°, -123.666295°)	Existing rusted-out 48” culvert	Remove existing culvert and replace with 48” CMP on-grade with stream channel	1	After DFW & RWB 401 approval; Prior to October 2020
RR-1	Refuse Removal from Site	Existing on-site refuse	Remove refuse from site; ensure that future refuse is fenced off from wildlife or stored in wildlife-proof container	1	Completed
WB	Water Bladders throughout property	The four water bladders located near Cultivation Areas 1 and 2 currently lack secondary containment	Install containment around water bladder or cease use of water bladders	2	Will eventually phase out bladders
WM	Water Meters at Points of Diversion	Diversion amounts are not properly metered	Purchase and install water meters on all sources of water (POD-3, POD-4, rainwater catchment) in a manner that records water use and type (i.e. separate out domestic water from irrigation water)	1	Completed
WZ	Winterization Measure: Soil Pile Stabilization	Soil piles are not fully tarped	Tarp under and around all soils piles, install erosion and sediment control BMPs (such as straw waddles around piles) prior to winterization	1	Completed

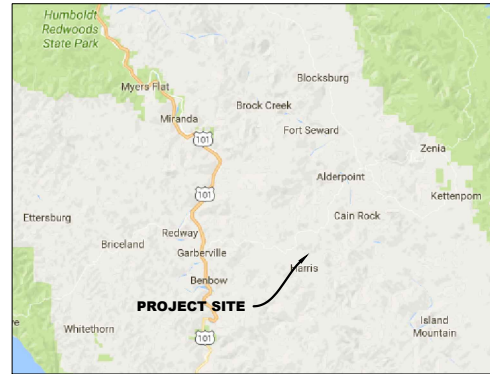

**VICINITY MAP**  
NOT TO SCALE

**DIRECTIONS TO SITE:**  
**FROM EUREKA, CA**  
**-SOUTHBOUND ON US-101**  
**(APPROX. 65.9 MILES)**  
**-TAKE EXIT 639B TOWARD REDWAY**  
**-TURN RIGHT ONTO REDWOOD DR**  
**(APPROX. .2 MILES)**  
**-TURN RIGHT ONTO ALDERPOINT RD**  
**(APPROX. 11.8 MILES)**  
**-TURN RIGHT ONTO HARRIS RD**  
**(APPROX. 1.9 MILES)**  
**SITE DRIVEWAY ON LEFT**

# JOURNEY AQUARIAN "POND" PARCEL

## SITE MANAGEMENT PLAN

APN: 216-136-004, 216-135-008

**LEGEND**

	ROLLING DIP
	CULVERT
	CRITICAL DIP
	OUTSLOPE

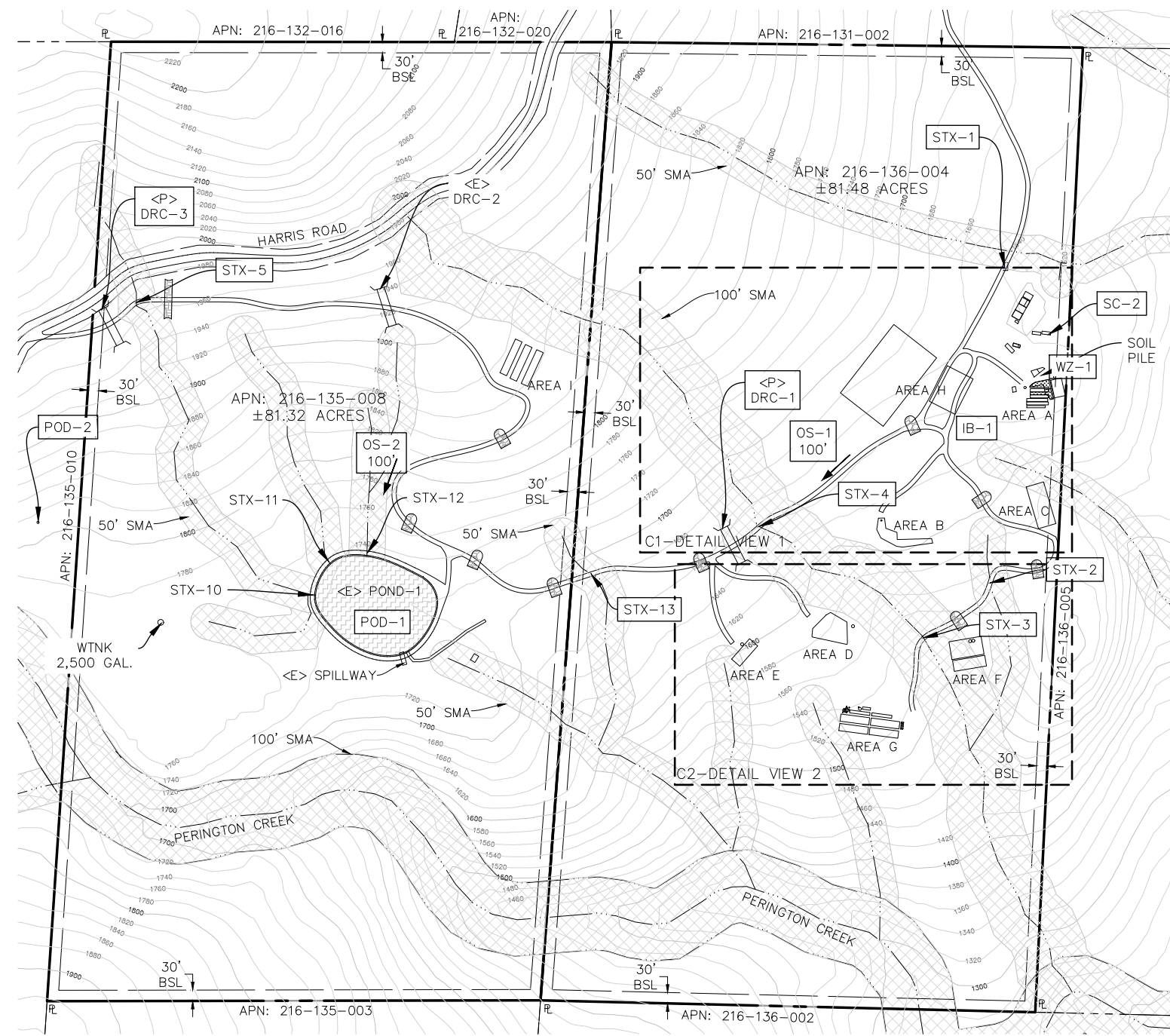

**PROJECT INFORMATION:**

**APPLICANT:**  
HUMBOLDT KINGZ, LLC.  
24534 TOWNSEND AVE  
HAYWARD, CA 94544

**PROPERTY OWNER:**  
JOURNEY AQUARIAN  
610 DRY CREEK RD.  
HEALDSBURG, CA 95448

**SITE ADDRESS:**  
APN: 216-136-004  
HARRIS, CA 95542

TREES TO BE REMOVED = NONE

EARTHWORK QUANTITIES = TBD

WATER = PRIVATE  
SEWER = PRIVATE

PARCEL SIZE-004 = ±81.48 ACRES

ZONING: = AE-B-5(160); TPZ  
GENERAL PLAN DESIGNATION = AG (FRWK)

**BUILDING SETBACKS:**

	AE	TPZ	SRA
FRONT	30'	20'	30'
SIDE	20'	30'	30'
REAR	10'	30'	30'

MAX. BLDG. HT. = 35'

SRA AREA: = YES  
IN COASTAL ZONE: = NO  
IN 100 YR FLOOD ZONE: = NO

**EXISTING AND PROPOSED CULTIVATION AREAS**

LOCATION	AREA (SQ FT)	CULTIVATION TYPE
AREA A	FROM ±7,000 TO ±5,500	OUTDOOR
AREA B	±4,000	OUTDOOR
AREA C	FROM ±6,000 TO ±2,700	OUTDOOR
AREA D	±4,100	OUTDOOR
AREA E	FROM ±2,800 TO ±0	OUTDOOR
AREA F	FROM ±7,500 TO ±0	OUTDOOR
AREA G	FROM ±11,660 TO ±8,650	OUTDOOR
<P> AREA H	±6,150	OUTDOOR
<P> AREA I	±6,150	OUTDOOR
TOTAL:	±37,250	

**PLOT PLAN**

22x34 SHEET: 1"=200'  
11x17 SHEET: 1"=400'

**SHEET INDEX:**

- C0 - SMP CORRECTIVE MAP
- C1 - DETAIL VIEW 1
- C2 - DETAIL VIEW 2
- C3 - DISTURBED AREA MAP

NO.	DATE	REVISIONS

**NORTHPOINT CONSULTING GROUP, INC.**  
1117 Samoa Blvd., Arcata, CA 95521

JOURNEY AQUARIAN - "POND" PARCEL  
HARRIS, CA 95542 / APN: 216-136-004, 216-135-008  
SITE MANAGEMENT PLAN

PROJ. MGR.: RJ  
DRAWN BY: CC  
DATE: 09/26/19  
SCALE: AS SHOWN

SHEET  
**C0**  
18-138

September 26, 2019 - 15:49 Dwg Name: P:\18-056 - Journey Aquarian - Property Three (Pond)\CAD\AQUARIAN-04-SMP.dwg Updated By: Chong Chang

LEGEND	
	ROLLING DIP
	CULVERT
	CRITICAL DIP
	OUTSLOPE

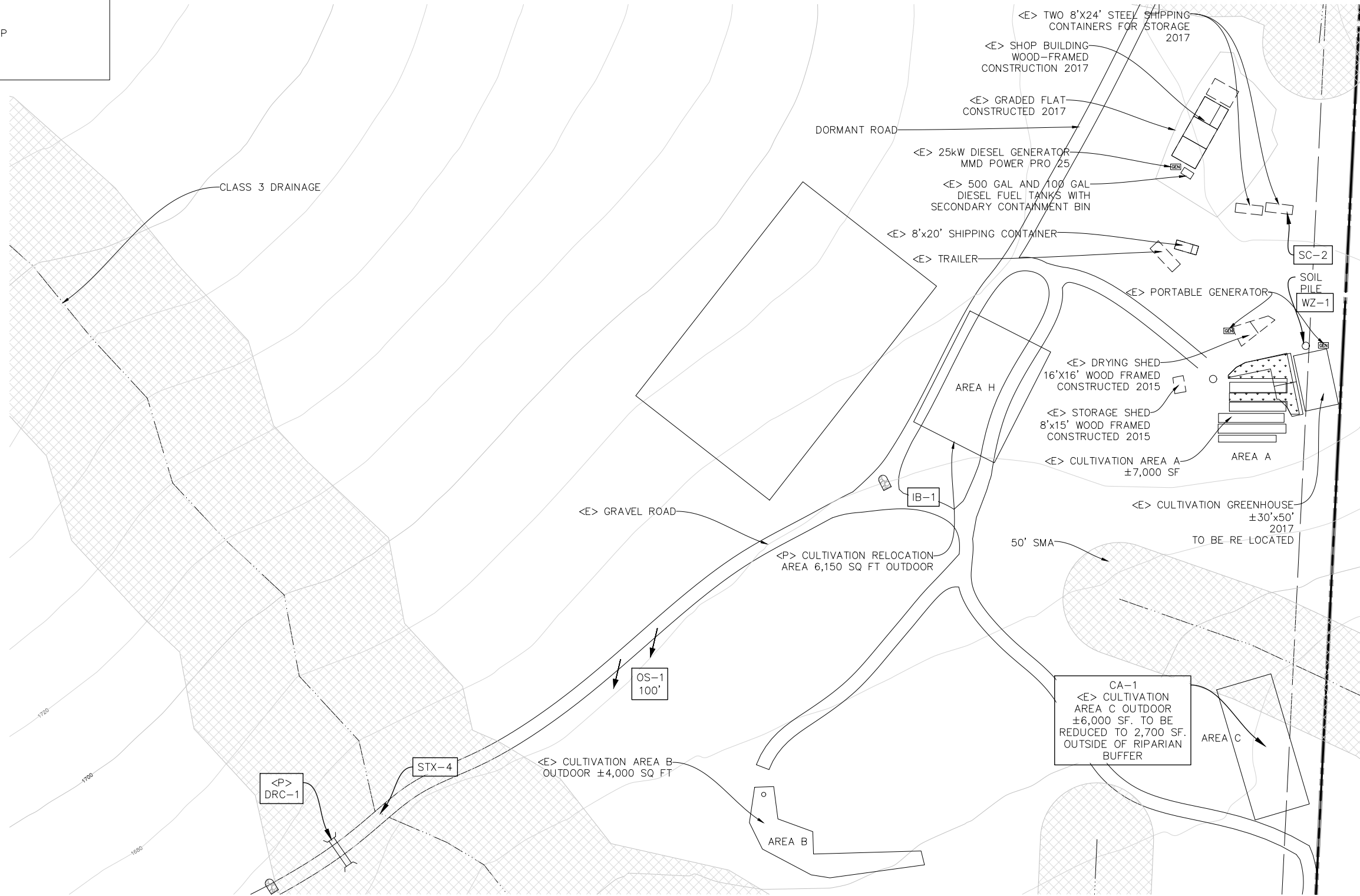

**PLOT PLAN**  
 22x34 SHEET: 1"=50'  
 11x17 SHEET: 1"=100'

- SHEET INDEX:**
- C0 - SMP CORRECTIVE MAP
  - C1 - DETAIL VIEW 1
  - C2 - DETAIL VIEW 2
  - C3 - DISTURBED AREA MAP

DATE	REVISIONS

**NORTHPOINT**  
 CONSULTING GROUP, INC.  
 1117 Samoa Blvd., Arcata, CA 95521

**JOURNEY AQUARIAN - "POND" PARCEL**  
 HARRIS, CA 95542 / APN: 216-136-004, 216-135-008  
 DETAIL VIEW 1

PROJ. MGR.: RJ  
 DRAWN BY: CC  
 DATE: 09/26/19  
 SCALE: AS SHOWN

SHEET  
**C1**  
 18-138

September 26, 2019 - 15:49 Dwg Name: P:\18-056 - Journey Aquarian - Property Three (Pond)\CAD\AQUARIAN-04-SMP.dwg Updated By: Chong Chang

LEGEND	
	ROLLING DIP
	CULVERT
	CRITICAL DIP
	OUTSLOPE

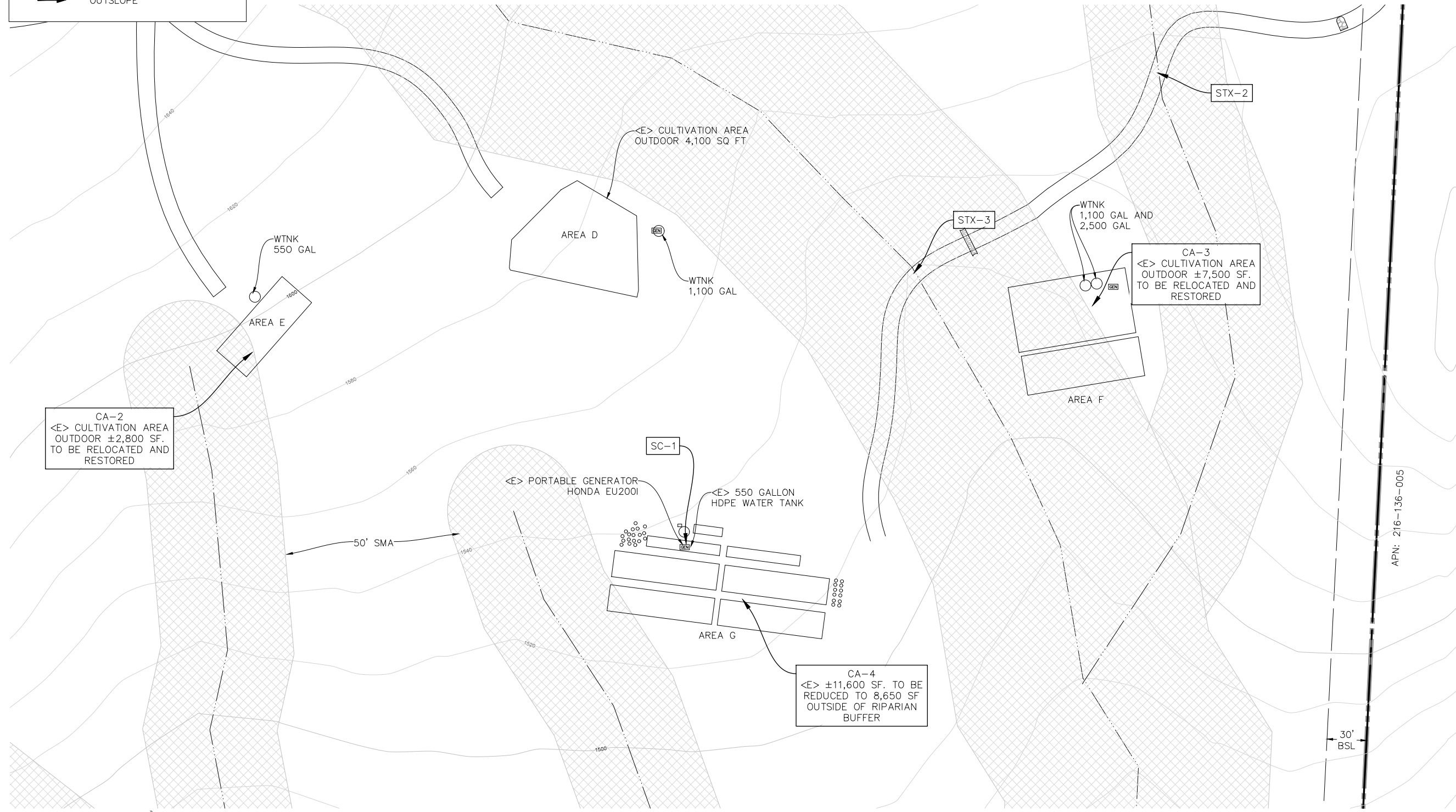

**PLOT PLAN**  
 22x34 SHEET: 1"=40'  
 11x17 SHEET: 1"=80'

**SHEET INDEX:**

- C0 - SMP CORRECTIVE MAP
- C1 - DETAIL VIEW 1
- C2 - DETAIL VIEW 2
- C3 - DISTURBED AREA MAP

NO.	DATE	REVISIONS

**NORTHPOINT**  
 CONSULTING GROUP, INC.  
 1117 Samoa Blvd., Arcata, CA 95521

**JOURNEY AQUARIAN - "POND" PARCEL**  
 HARRIS, CA 95542 / APN: 216-136-004, 216-135-008  
 DETAIL VIEW 2

PROJ. MGR.:	RJ
DRAWN BY:	CC
DATE:	09/26/19
SCALE:	AS SHOWN

SHEET  
**C2**

September 26, 2019 - 15:49 Dwg Name: P:\18-056 - Journey Aquarian - Property Three [Prop]\CAD\AQUARIAN-04-SMP.dwg Updated By: Chong Chang



**VICINITY MAP**  
NOT TO SCALE

**DIRECTIONS TO SITE:**  
**FROM EUREKA, CA**  
**-SOUTHBOUND ON US-101 (APPROX. 65.9 MILES)**  
**-TAKE EXIT 639B TOWARD REDWAY (APPROX. .2 MILES)**  
**-TURN RIGHT ONTO REDWOOD DR (APPROX. 11.8 MILES)**  
**-TURN RIGHT ONTO ALDERPOINT RD (APPROX. 1.9 MILES)**  
**-TURN RIGHT ONTO HARRIS RD (APPROX. 1.9 MILES)**  
**SITE DRIVEWAY ON LEFT**

# JOURNEY AQUARIAN "POND" PARCEL SITE MANAGEMENT PLAN

APN: 216-136-004, 216-135-008

LEGEND	
	ROLLING DIP
	CULVERT
	CRITICAL DIP
	OUTSLOPE
	DISTURBED AREA

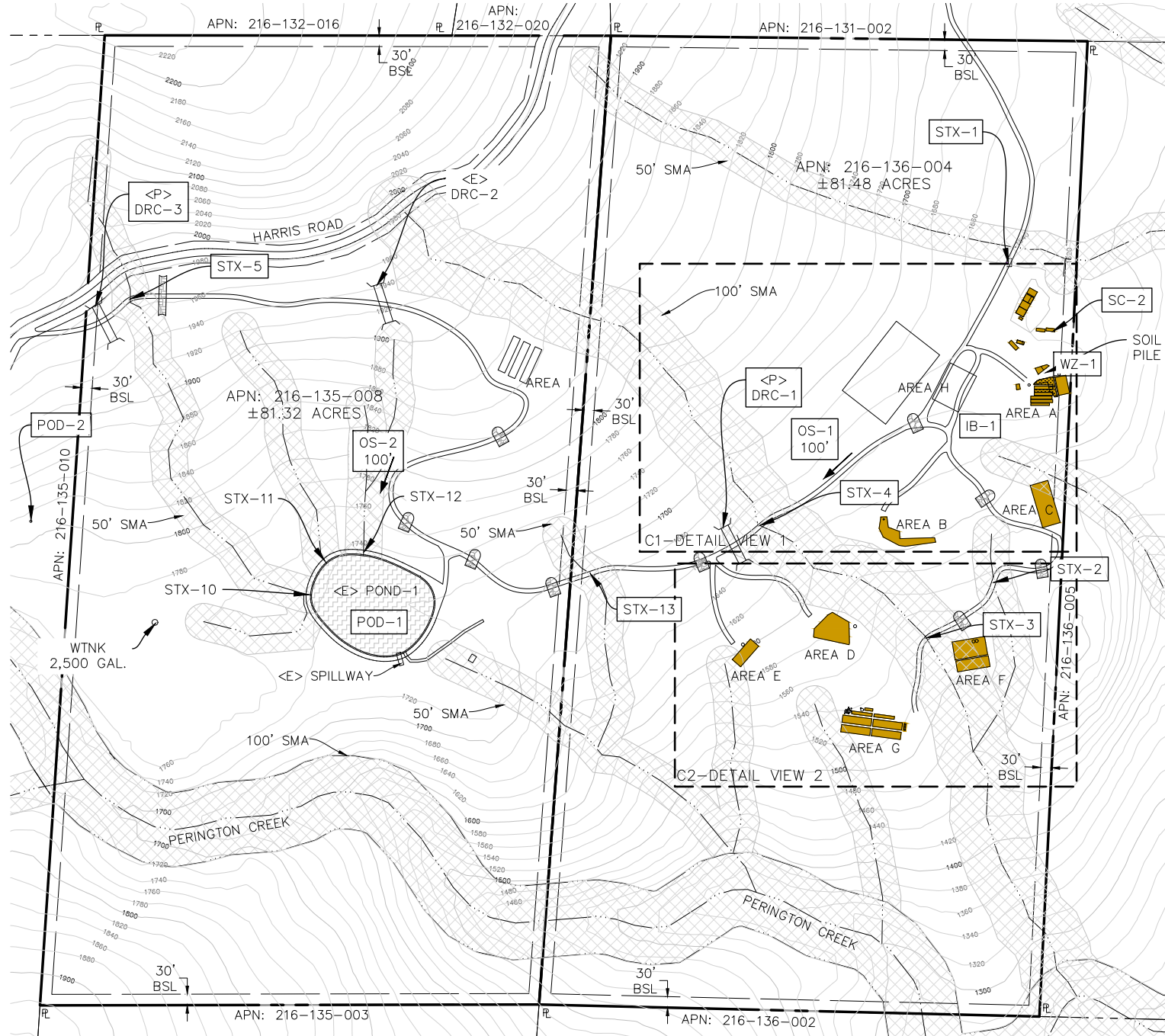

**PLOT PLAN**

22x34 SHEET: 1"=200'  
 11x17 SHEET: 1"=400'  
 0 100 200 400



**PROJECT INFORMATION:**

**APPLICANT:**  
 HUMBOLDT KINGZ, LLC.  
 24534 TOWNSEND AVE  
 HAYWARD, CA 94544

**PROPERTY OWNER:**  
 JOURNEY AQUARIAN  
 610 DRY CREEK RD.  
 HEALDSBURG, CA 95448

**SITE ADDRESS:**  
 APN: 216-136-004  
 HARRIS, CA 95542

TREES TO BE REMOVED = NONE

EARTHWORK QUANTITIES = TBD

WATER = PRIVATE  
 SEWER = PRIVATE

PARCEL SIZE-004 = ±81.48 ACRES

ZONING: = AE-B-5(160); TPZ  
 GENERAL PLAN DESIGNATION = AG (FRWK)

**BUILDING SETBACKS:**

	AE	TPZ	SRA
FRONT	30'	20'	30'
SIDE	20'	30'	30'
REAR	10'	30'	30'

MAX. BLDG. HT. = 35'

SRA AREA: = YES  
 IN COASTAL ZONE: = NO  
 IN 100 YR FLOOD ZONE: = NO

**EXISTING AND PROPOSED CULTIVATION AREAS**

LOCATION	AREA (SQ FT)	CULTIVATION TYPE
AREA A	FROM ±7,000 TO ±5,500	OUTDOOR
AREA B	±4,000	OUTDOOR
AREA C	FROM ±6,000 TO ±2,700	OUTDOOR
AREA D	±4,100	OUTDOOR
AREA E	FROM ±2,800 TO ±0	OUTDOOR
AREA F	FROM ±7,500 TO ±0	OUTDOOR
AREA G	FROM ±11,660 TO ±8,650	OUTDOOR
<P> AREA H	±6,150	OUTDOOR
<P> AREA I	±6,150	OUTDOOR
TOTAL:	±37,250	

**SHEET INDEX:**

C0 - SMP CORRECTIVE MAP  
 C1 - DETAIL VIEW 1  
 C2 - DETAIL VIEW 2  
 C3 - DISTURBED AREA MAP

NO.	DATE	REVISIONS

**NORTHPOINT CONSULTING GROUP, INC.**  
 1117 Samoa Blvd., Arcata, CA 95521

**JOURNEY AQUARIAN - "POND" PARCEL**  
 HARRIS, CA 95542 / APN: 216-136-004, 216-135-008  
 DISTURBED AREA MAP

PROJ. MGR.: RJ  
 DRAWN BY: CC  
 DATE: 09/26/19  
 SCALE: AS SHOWN

SHEET  
**C3**  
 18-138

# JOURNEY AQUARIAN - "RANCH" PARCEL

## SITE MANAGMENT PLAN

### DISTURBED AREA MAP

APN: 216-081-013

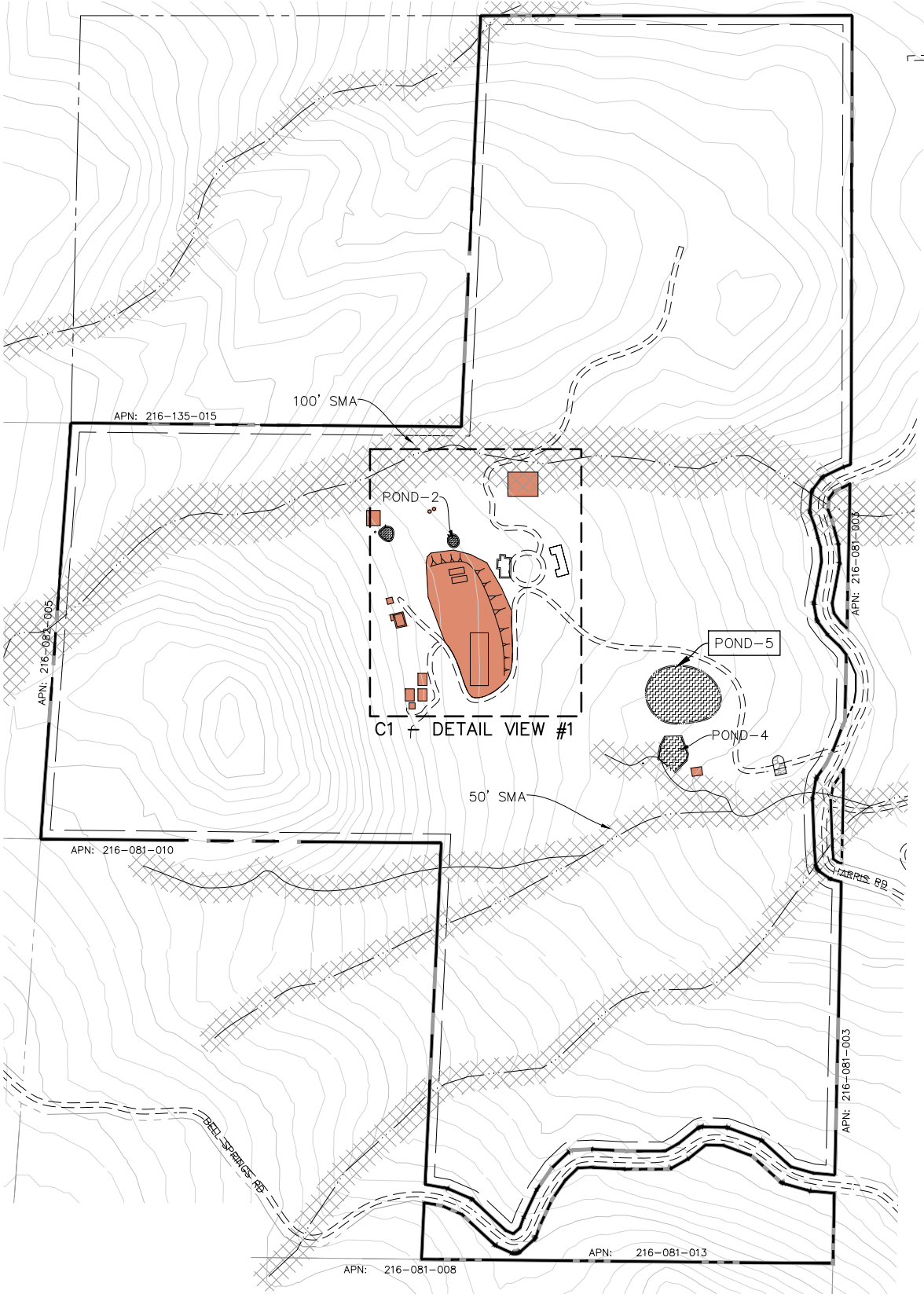

**VICINITY MAP**  
NOT TO SCALE

**DIRECTIONS TO SITE:**  
**FROM EUREKA, CA**  
 -TAKE 101 SOUTH (66 MILES)  
 -TAKE EXIT 639b AND TURN RIGHT ON REDWOOD DR. (0.2 MILES)  
 -TURN RIGHT ON ALTERPOINT RD. (8.0 MILES)  
 -TURN RIGHT ON BELL SPRINGS RD (2.5 MILES)  
 -TURN ON HARRIS RD (0.7 MILES)  
 -PROJECT LOCATION LEFT

LEGEND	
	ROLLING DIP
	CUT/FILL SLOPE
	DISTURBED AREA

TOTAL DISTURBED AREA: 85,176 SQ. F.T

**DISTURBED AREA MAP**

22x34 SHEET: 1"=250'  
 11x17 SHEET: 1"=500'

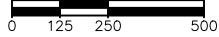

DATE	REVISIONS

**NORTHPOINT**  
 CONSULTING GROUP, INC.  
 1117 Samoa Blvd., Arcata, CA 95521

JOURNEY AQUARIAN - "RANCH" PARCEL  
 HARRIS, CA / APN: 216-081-013  
 SITE MANAGEMENT PLAN - DISTURBED AREA MAP

**SHEET INDEX:**  
 SMP0 - DISTURBED AREA MAP  
 SMP1 - DETAIL VIEW #1



PROJ. MGR.:	RJ
DRAWN BY:	CC
DATE:	09/26/19
SCALE:	AS SHOWN
SHEET	
<b>SMP0</b>	
18-055	

September 26, 2019 - 13:08 - Dwg Name: F:\18-055 - Journey Aquarian - Property Two (Ranch)\CAD\AQUARIAN-013-SMP.dwg - Updated By: Chao, Cheng

# JOURNEY AQUARIAN - "RANCH" PARCEL

## DETAIL VIEW #1

APN: 216-081-013

LEGEND	
	ROLLING DIP
	CUT/FILL SLOPE

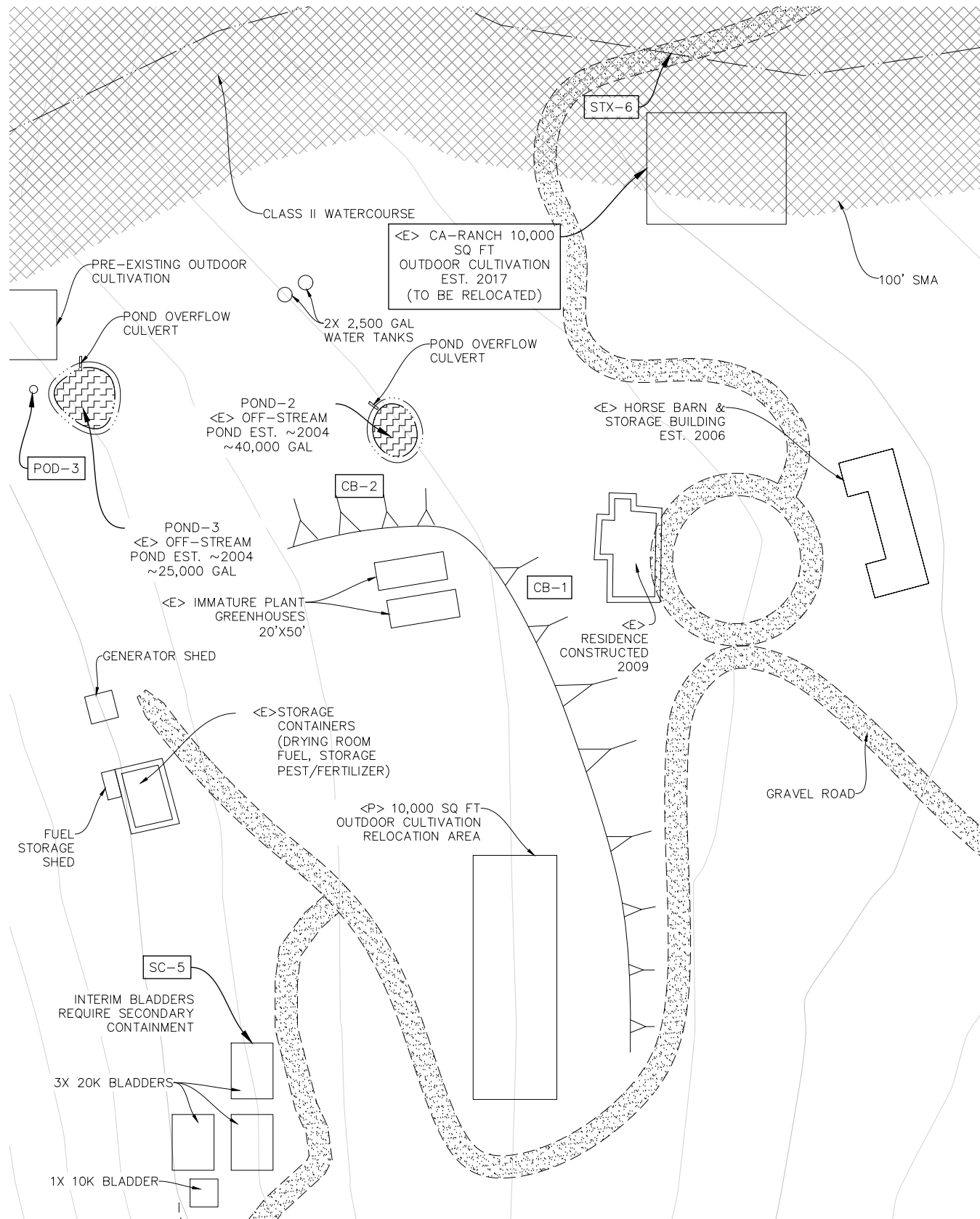

### DETAIL VIEW

22x34 SHEET: 1"=50'

11x17 SHEET: 1"=100'

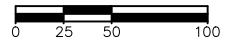

September 26, 2019 - 13:08 - Draw Name: F:\18-055 - Journey Aquarian - Property Two (Ranch)\CAD\AQUARIAN-013-SMP.dwg - Updated By: Chao, Cheng

DATE	REVISIONS

**NORTHPOINT**  
 CONSULTING GROUP, INC.  
 1117 Samoa Blvd., Arcata, CA 95521

JOURNEY AQUARIAN - "RANCH" PARCEL  
 HARRIS, CA / APN: 216-081-013  
 SITE MANAGEMENT PLAN - DETAIL VIEW 1

PROJ. MGR.:	RJ
DRAWN BY:	CC
DATE:	09/26/19
SCALE:	AS SHOWN
SHEET	
<b>SMP1</b>	
18-055	

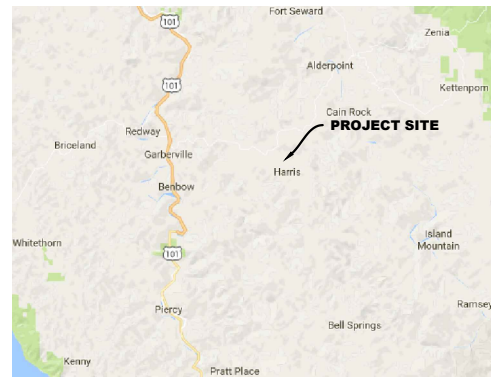

**VICINITY MAP**  
NOT TO SCALE

**DIRECTIONS TO SITE:**  
**FROM EUREKA, CA**  
**-SOUTHBOUND ON US-101**  
**(APPROX. 65.9 MILES)**  
**-TAKE EXIT 639B TOWARDS REDWAY**  
**(APPROX. .2 MILES)**  
**-TURN RIGHT ONTO ALDERPOINT RD**  
**(APPROX. 8 MILES)**  
**-TURN RIGHT ONTO BELL SPRINGS RD**  
**(APPROX. .9 MILES)**  
**-TURN LEFT ONTO HARRIS RD**  
**(APPROX. 1.2 MILES)**  
**-SITE DRIVEWAY ON LEFT**

# JOURNEY AQUARIAN - "THUNDER" PARCEL

## SITE MANAGEMENT PLAN

**SITE OVERVIEW**  
**APN: 216-135-015**

**PROJECT INFORMATION:**

**APPLICANT:**  
 MYERS AND AQUARIAN, LLC  
 401 CENTER ST. #3  
 HEALDSBURG, CA 95448

**PROPERTY OWNER:**  
 JOURNEY AQUARIAN  
 610 DRY CREEK RD.  
 HEALDSBURG, CA 95448

**OWNERS AGENT:**  
 JOURNEY AQUARIAN  
 610 DRY CREEK RD.  
 HEALDSBURG, CA 95448

**SITE ADDRESS:**  
 APN: 216-135-015  
 HARRIS, CA 95542

**GENERAL NOTES:**

1. DRAWING SCALE AS NOTED. WRITTEN DIMENSIONS SHALL TAKE PRECEDENCE OVER SCALED DIMENSIONS.
2. THIS IS NOT A BOUNDARY SURVEY. BOUNDARY INFORMATION DEPICTED HAS BEEN OBTAINED FROM HUMBOLDT COUNTY 2015 GIS DATA. NORTHPOINT CONSULTING GROUP, INC. HAS NOT VERIFIED THIS PROPERTY BOUNDARY.

LEGEND	
	ROLLING DIP
	STREAM CROSSING
	DITCH RELIEF CULVERT

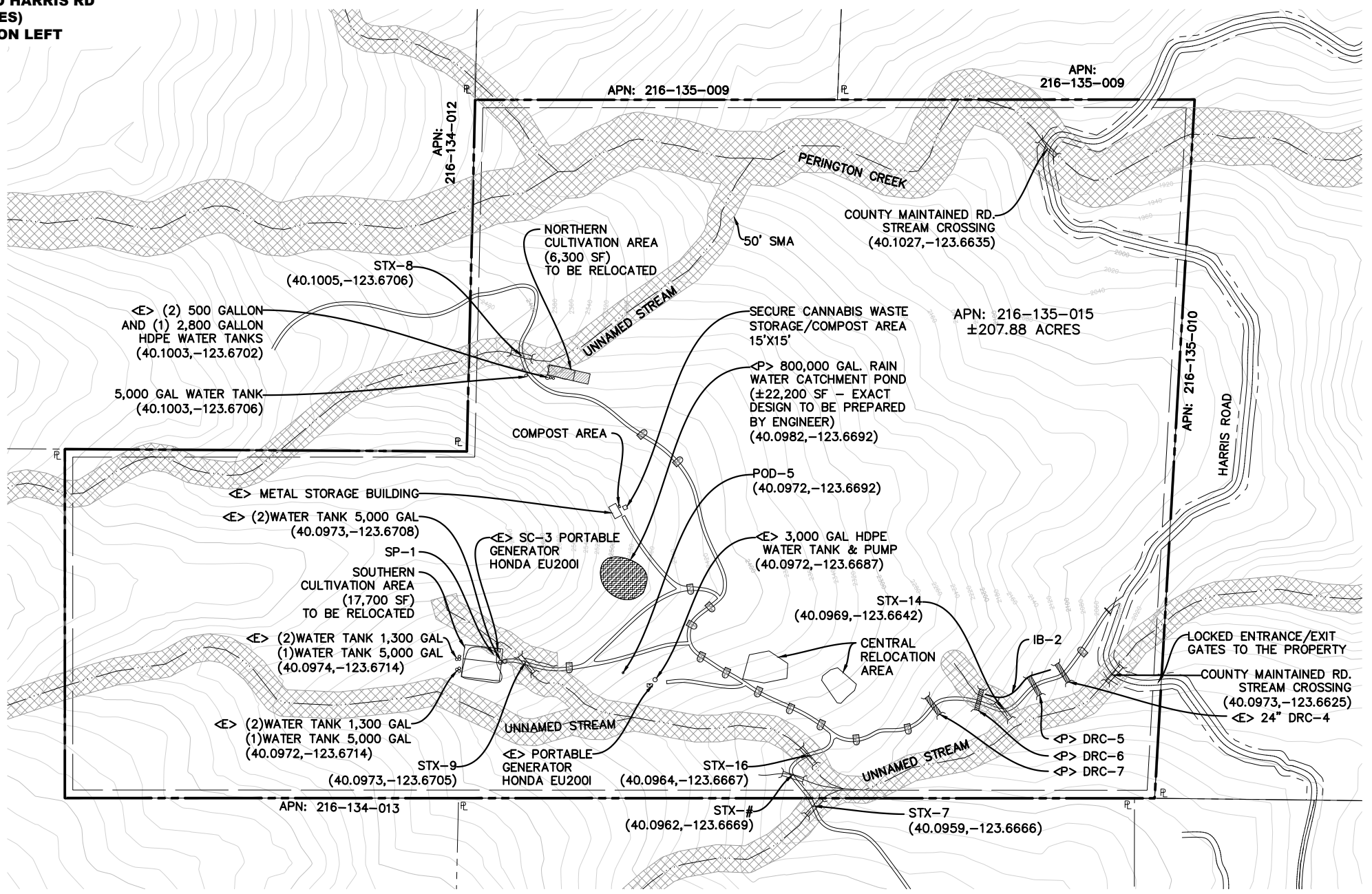

**SITE OVERVIEW**

22x34 SHEET: 1"=300'  
 11x17 SHEET: 1"=600'

**SHEET INDEX:**

SMPO - SITE OVERVIEW  
 SMP1 - DISTURBED AREA MAP

DATE	REVISIONS

**NORTHPOINT CONSULTING GROUP, INC.**  
 1117 Samoa Blvd., Arcata, CA 95521

**JOURNEY AQUARIAN - "THUNDER"**  
 HARRIS, CA 95542 / APN: 216-135-015  
**SITE MANAGEMENT PLAN - SITE OVERVIEW**

PROJ MGR: RJ  
 DRAWN BY: CJG  
 DATE: 09/26/19  
 SCALE: AS SHOWN

SHEET  
**SMPO**  
 18-054

September 26, 2019 - 13:13 Draw Name: P:\18-054 - Journey Aquarian - Property On (22X)CAD\AQUARIAN-015-SMP.dwg Updated By: Chuan Chen





# RD-1.1 MODIFIED LOW WATER ROCK FORD

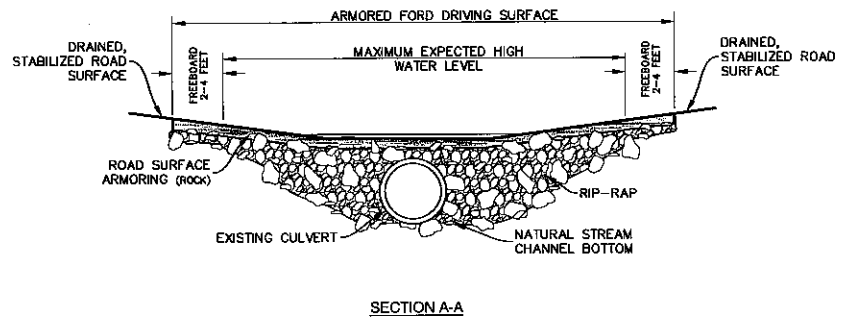
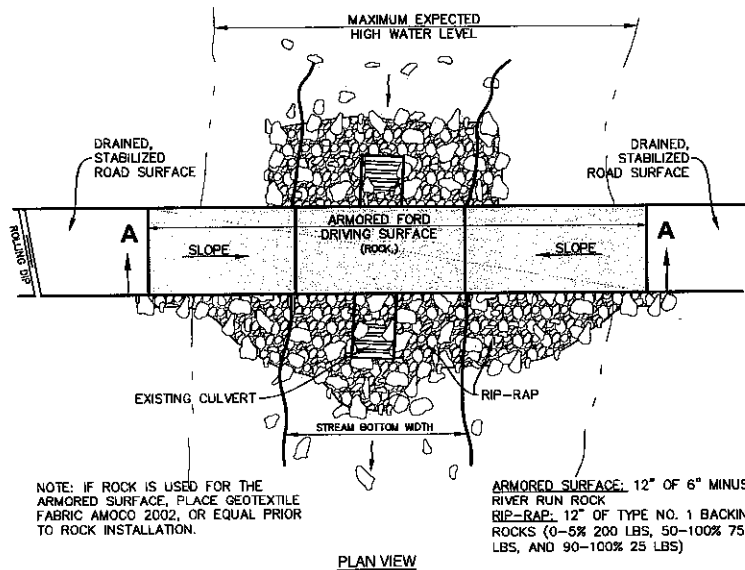

## RD-1.2 FORDS

### DESCRIPTION

Fords work well on small to medium sized streams where there is a stable stream bottom and traffic is light. However, "construction" of fords and other unimproved stream crossings on well traveled roads should be avoided where water is flowing because of their potential to impact water quality. In certain situations, where flash floods, high seasonal flood peaks or floating debris are problems, fords may be a practical answer for crossing a poorly incised, shallow stream.

### BEST MANAGEMENT PRACTICES

- Fords in flowing streams, called "wet fords," are typically composed of streambed gravels, fill, or concrete structures built in contact with the streambed so that vehicles can cross the channel (Figure 1).
- Fords should be designed to allow low summer flows seep through the fill, and high water discharges flow over the top (Figure 2).
- Paving fords across flowing streams may be necessary to maintain water quality if there is to be regular traffic. Paving consists of a concrete, slightly dish-shaped slab across the watercourse, and a discharge apron or energy dissipater on the downstream side to prevent scour during high flows.
- On small, poorly incised, ephemeral or intermittent streams a ford may be needed if there is insufficient channel depth to install a culvert. In fact, a rock lined rolling dip with a rock apron face is generally desirable to permanent culverts on these swales and small watercourses. Fords have the advantage, over culverted fills, of never plugging.
- Fords on small streams should be rock armored to prevent erosion of the road surface and fill during periods of runoff. The fill face on the downstream side of the fill can either be protected with rock armor or fitted with a large overside drain (berm drain) to prevent erosion (Figure 3).
- Unimproved fords, which consist of a stream channel that has been filled with a substantial quantity of soil and left unprotected by armor or surfacing is a hazard to water quality and should not be constructed.

*Figure 1. Wet ford on Class II perennial stream. Clean rock aggregate has been imported for the travelling surface and coarse rock armor protects the outer edge of the road bed. It is important that rock aggregate used in a ford be large enough to resist transport during winter flows. Fords should not be used if high winter flows would cut off access to inspect and maintain drainage structures further out the road. From Weaver and Hagans (1994).*



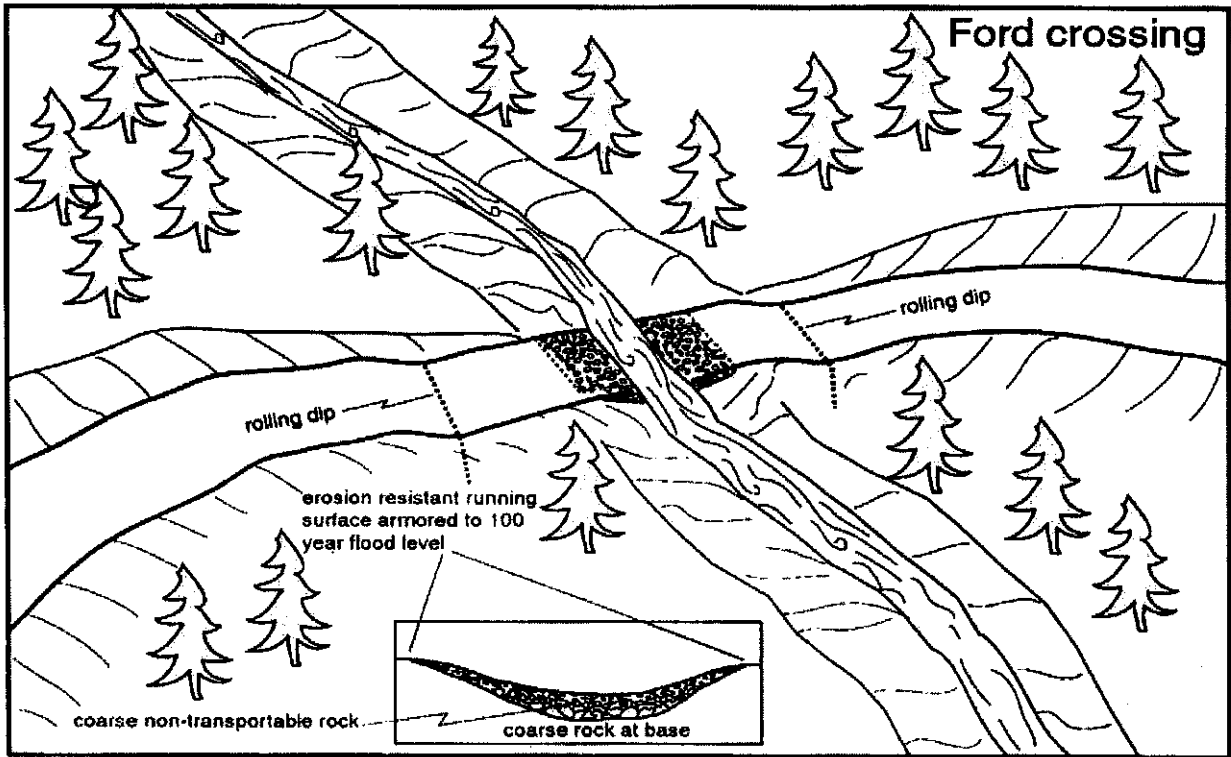

Figure 2. Typical ford stream crossing. From CDFG (2006).

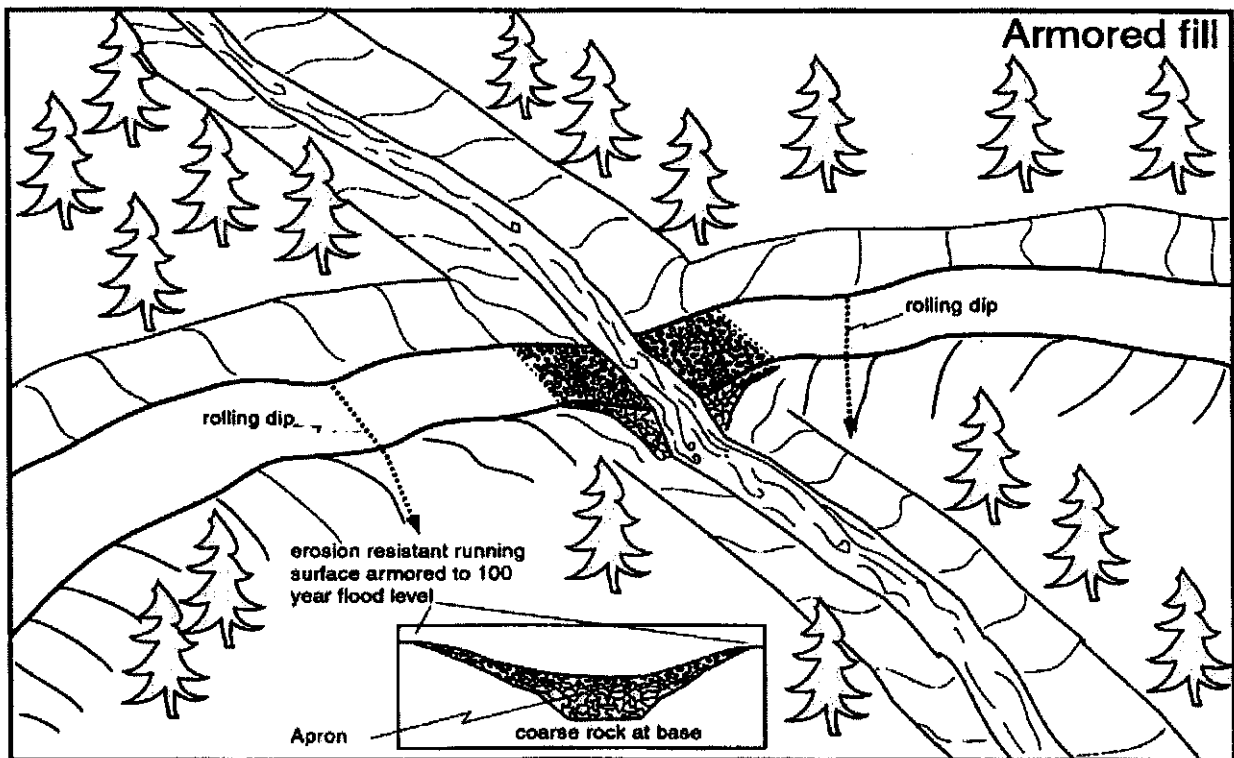

Figure 3. Typical armored stream crossing. From CDFG (2006).

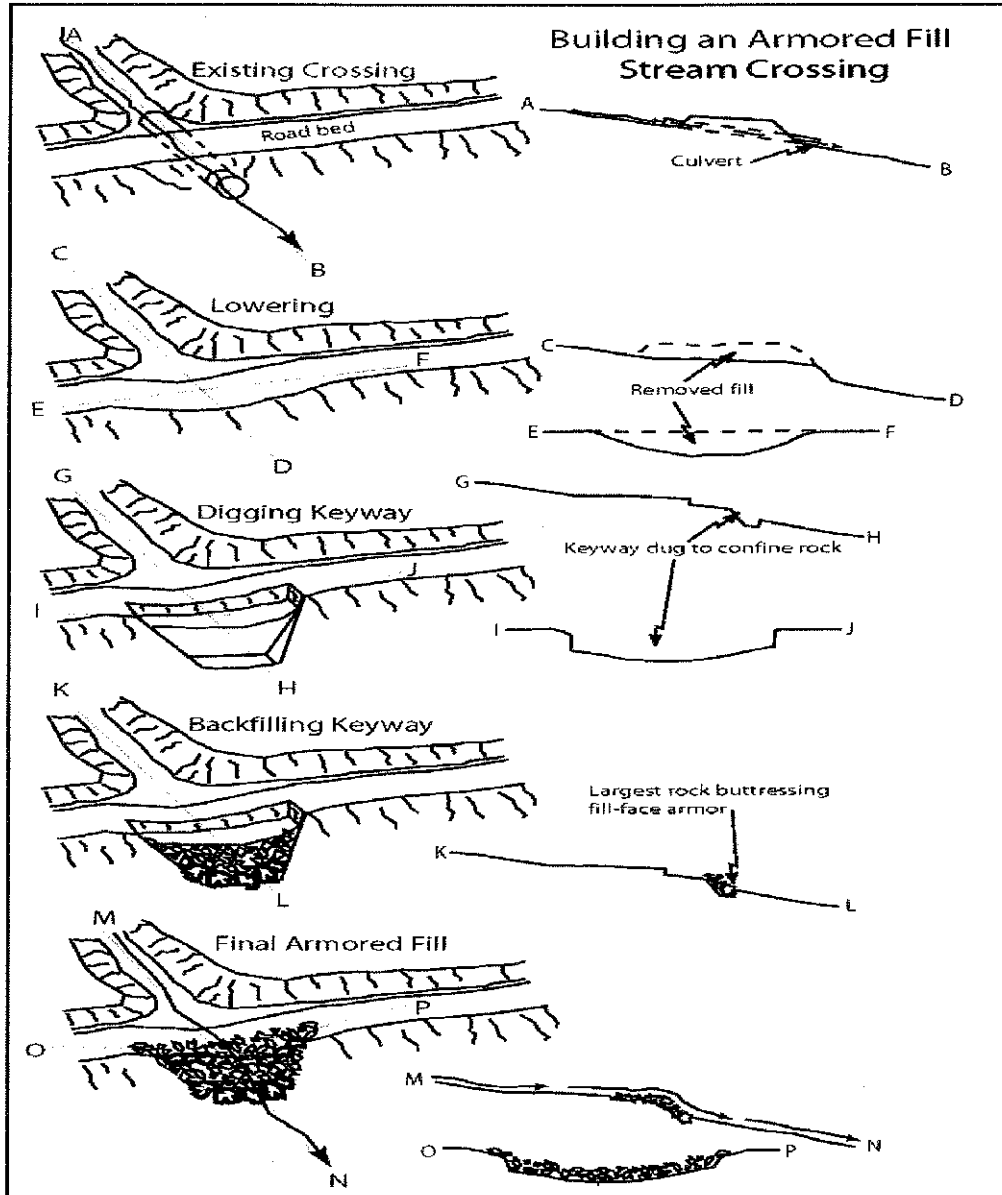

Figure 4. Design elements of a typical armored fill crossing. Note: where geotextile fabric may interfere with passage of amphibians in any Class 2 or 3 crossing, bury geotextile fabric with at least 6 inches of rock. Do not expose geotextile fabric in the bed of fish-bearing stream channels. From CDFG (2206).

**Source Material for Road BMP RD-2.7 Fords**

2006. California Department of Fish and Game. Part X - Upslope Erosion Inventory and Sediment Control Guidance, California Salmonid Stream Habitat Restoration Manual.

1994. Weaver W.E. and D.K. Hagans. Handbook for Forest and Ranch Roads. Mendocino County Resource Conservation District

# RD-1.3 OUTSLOPED ROAD W/ INBOARD SWALE

NOTE: ALL ROAD WIDTHS TO BE 12' MINIMUM AND ROCKED/REINFORCED WITH 2" MINIMUM AGG. BASE FROM ON SITE SOURCE

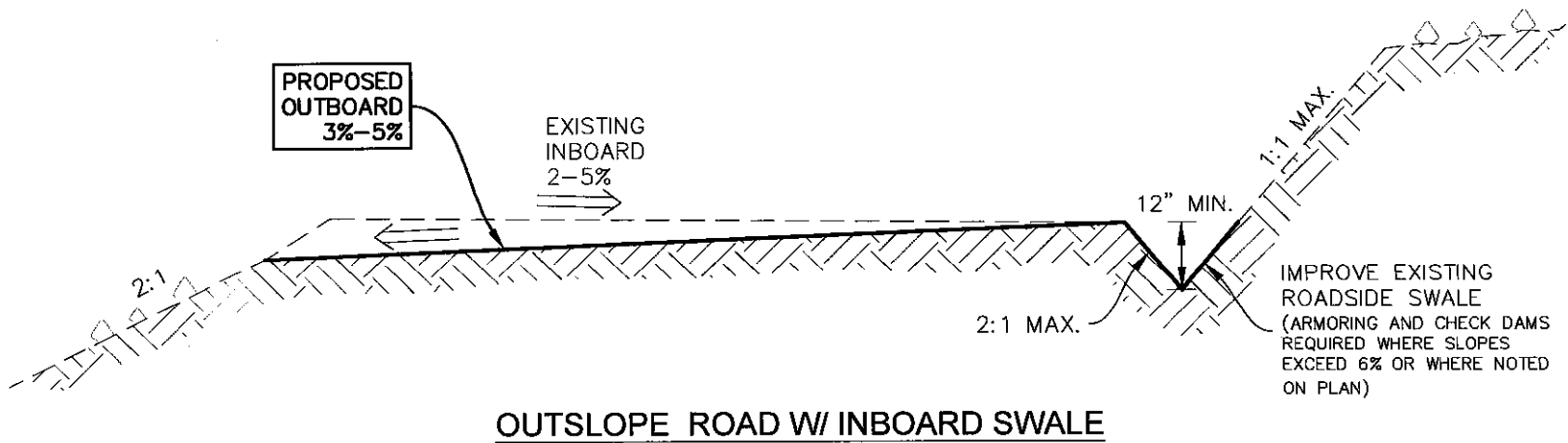

# RD-1.4 OUTSLOPED ROAD

NOTE: ALL ROAD WIDTHS  
TO BE 12' MINIMUM AND  
ROCKED/REINFORCED WITH  
2" MINIMUM AGG. BASE  
FROM ON SITE SOURCE

NOTE: ALL ROAD WIDTHS  
TO BE 12' MINIMUM

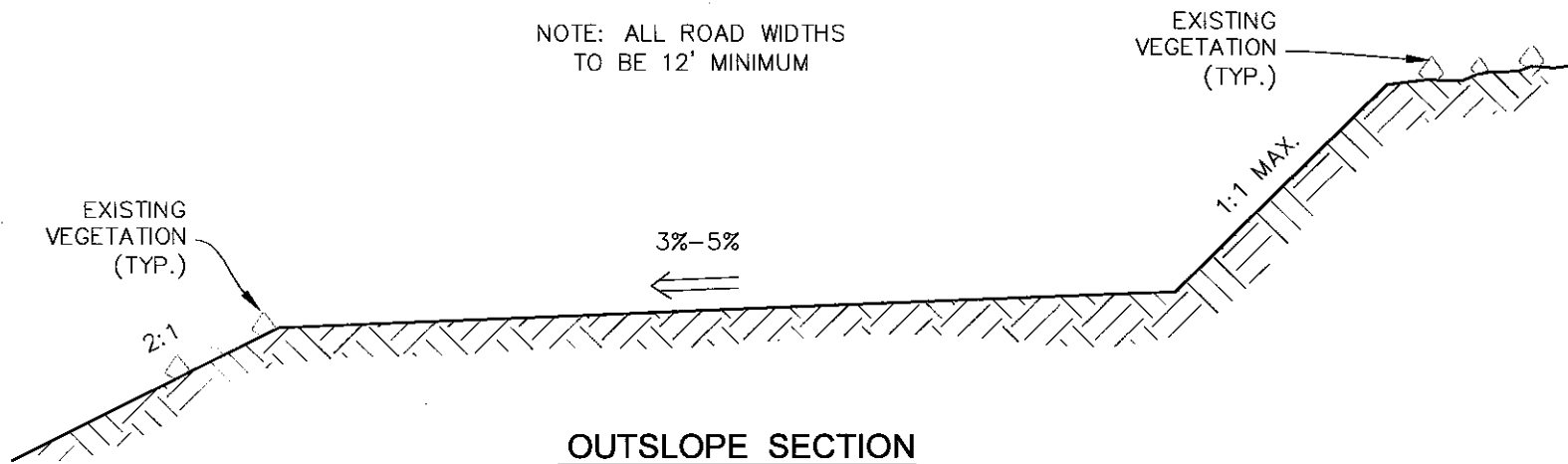

# RD-1.5 INSLOPE ROAD

NOTE: ALL ROAD WIDTHS  
TO BE 12' MINIMUM AND  
ROCKED/REINFORCED WITH  
2" MINIMUM AGG. BASE  
FROM ON SITE SOURCE

NOTE: ALL ROAD WIDTHS  
TO BE 12' MINIMUM

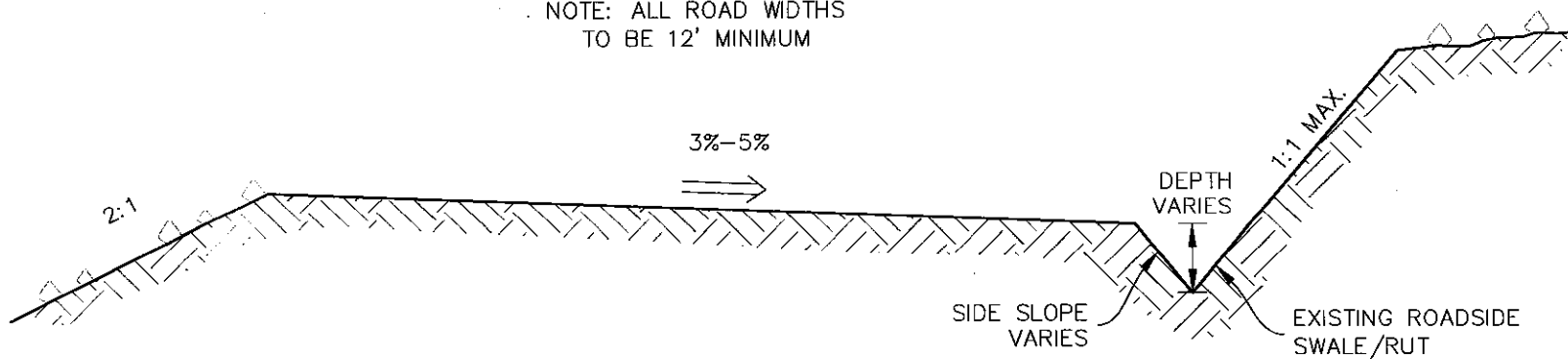

INSLOPE SECTION



## **RD-1.16 UNDERSTANDING ROAD REMOVAL**

### **DESCRIPTION**

Approaches to removing roads may be divided into six categories: closure, abandonment, reclassification as trail, decommissioning, conversion to trail, and obliteration (Figure 1).

### **REMOVAL OPTIONS**

#### **Closure**

Some agencies close roads with gates, berms, or deep ditches (tank traps) as an approach to road removal (see Road BMP RD-7.3 Road Closure). On-the-ground surveys indicate that conventional closure devices are ineffective at stopping road use by people intent on accessing restricted areas. With an effective device that prohibits motorized access, however, closure may reduce a road's terrestrial impacts by providing wildlife security. Even so, closure is an ineffective approach to removing a road, because the road continues to disrupt natural drainage patterns, cause soil erosion, and potentially initiate mass failures; in short, a closed road continues to impact aquatic ecosystems.

#### **Abandonment**

When a road is "abandoned," it is no longer maintained and may or may not be driveable based on physical conditions or the presence of vegetation. The Forest Service considers road abandonment a "no-action treatment" (Moll 1996). Like a closed road with an effective closure device, abandoned roads that no longer receive motorized use may reduce a road's terrestrial impacts by providing wildlife security. Simply discontinuing maintenance and abandoning a road, however, rarely prevents continuing and potential hydrologic problems. The presence of vegetation may provide the false idea that the road is recovering and is no longer problematic. Culverts can become plugged, and roads may continue to function as surface flow paths for water. Road fills may remain unstable and susceptible to failure. Because an abandoned road continues to impact aquatic ecosystems, abandonment is an ineffective approach to removing a road.

#### **Reclassification as Trail**

Reclassifying a road as a trail without restoring drainage patterns and stabilizing fill materials is not an effective approach to removing a road, especially if motorized use continues. Even if wildlife security is improved by stopping motorized use, simply reclassifying a road as a trail does not address a road's aquatic impacts; this type of approach is basically the same as abandonment. If a road is changed to a trail, it must be actively converted (see "Conversion to trail" below) by first stabilizing fill materials and dispersing concentrated water.

#### **Decommissioning**

Decommissioning is carried out to minimize shortterm sediment production, while "storing" a road for future use. Major treatments include removing stream crossings and stabilizing sidecast fill material. Site-specific drainage treatments such as constructing cross road drains, removing inboard ditches, and/or outsloping also help disperse concentrated water. Road surfaces may be mechanically scarified to facilitate revegetation. The goal of decommissioning is to leave much of the road prism intact so the road can be reconstructed in the future with only minimal effort. Decommissioning preserves most of the original construction investment, while reducing road-caused erosion and avoiding maintenance and/or repair costs. Other common terms used to indicate road removal with plans for future reconstruction

include storm-proofing, flood-proofing, erosion-proofing, putting-to-bed, deactivation, reclamation, hydrologic closure, hydrologic obliteration, and storage for future use. Planning for reconstruction and leaving much of the road prism intact may result in treating a road too lightly during removal. Future plans may change; post-decommissioning is too late to further treat the road for the long-term. Even if decommissioning stops road-related erosion in the shortterm, it is not the same as obliterating a road because the road is expected to be reconstructed. Even if roads may be reconstructed in the future, they should be removed as if reconstruction will not occur.

**Conversion to Trail**

Converting a road to a modest walking trail can be an effective approach to removing a road if all fill materials are stabilized before the trail is constructed. Some road-to-trail conversions are implemented by only partially recontouring a road, which may not stabilize all fill materials. Conversion is ineffective when ORVs are allowed because impacts associated with motorized use continue. Though trails are less intrusive and damaging than roads, they can cause similar impacts, such as stream sedimentation and facilitation of non-native species invasions.

**Obliteration**

Obliteration involves removing a road with no plans for future reconstruction. To be most effective, obliteration restores the original landform to the greatest extent possible. Stream crossings are removed and slopes are recontoured. Road surfaces and fill sites are ripped to improve subsurface water flow. Coarse woody debris placed on the recontoured road surface provides erosion protection, long-term nutrient sources, and wildlife habitat. Revegetation is also actively carried out with native species collected near the site. Fully obliterating roads speeds the restoration and recovery of hydrologic function, as well as ecological and evolutionary processes. If implemented appropriately, obliteration is the most effective approach to road removal since it addresses both terrestrial and aquatic impacts caused by roads.

Road impact considerations	How different approaches to removing roads address road impact considerations					
	Close	Abandon	Reclassify as trail	Decommission	Convert to trail	Obliterate
Is wildlife security improved?	Yes* (short-term)	Yes (long-term)	Depends on extent of trail use	Yes* (short-term)	Depends on extent of trail use	Yes* (long-term)
Are fill stability problems fixed?	No	No	No	Yes* (short-term)	Yes*	Yes*
Is surface erosion controlled?	No	No	No	Yes* (short-term)	No* (much reduced)	Yes*
Will the road be reopened or reconstructed?	Yes	No	No	Yes	No	No
Is motorized use accommodated? **	Yes	Yes (unless overgrown)	Yes	No*	Yes	No*
Will continued maintenance and repair funding be necessary?	Yes	No	Yes	No* (until reconstructed)	Yes	No*
* if implemented effectively ** decommissioned and obliterated roads may continue to accommodate winter use by snowmobiles						

Figure 1. From Bagley (1998).

## **REMOVAL TREATMENT OPTIONS**

Specific road removal treatments include removing stream crossings, constructing cross road drains, ripping, recontouring, and outsloping. Each treatment is summarized below.

### **Stream Crossing**

Stream crossing removal is a fundamental treatment for removing roads. When done correctly, stream crossings are removed by excavating all fill materials and restoring the original channel and valley shape. Simply removing culverts is not enough, because any remaining road fill will erode into the channel. Materials excavated from stream crossings can be used to recontour road segments to their natural slope, essentially returning fill to the location from which it was cut. Endhauling is necessary when the amount of fill removed is greater than that needed for recontouring. Any road removal project that does not remove stream crossings (or does not remove all fill materials) is not effective and may cause more ecological damage by causing additional sedimentation.

### **Cross Road Drains**

Cross road drains are deep ditches excavated across road surfaces (similar to waterbars, but more substantial) to facilitate drainage on closed roads. They are too deep and steep to be cleared by motor vehicles. Unless spaced frequently enough to disperse concentrated water, cross road drains may cause erosion downslope. They must be constructed more frequently on roads with steep grades, but are not necessary if roads are fully recontoured or outsloped steeply.

### **Ripping**

Ripping involves decompacting road surfaces and fill sites to a depth of two to three feet. The goal is to enhance subsurface water flow by reducing soil density and increasing porosity, infiltration, and percolation. Ripping relatively impermeable fill sites reduces the chance of fill saturation and failure. Some soil settling occurs since organic matter is limited in sterile road soils. Therefore, adding organic matter to the ripped soil can greatly accelerate the recovery of hydrologic function, including both infiltration and percolation (Luce 1997). Ripping also increases revegetation success.

### **Recontouring**

Recontouring involves placing all fill materials back into locations where fill was removed during road construction. Recontouring restores the original slope as much as possible, dispersing concentrated water and greatly enhancing slope stability. Full recontouring is sometimes impossible, especially on very steep slopes, since the sidecast material may have slid downhill out of reach. In some cases, cutslopes will be so high and road cuts so narrow, that replaced fill material will not blend with the original undisturbed slope. Even so, slope recontouring to the extent possible generally results in the most stable landform shape, restores natural surface runoff patterns, and deters motorized access.

### **Outsloping**

Outsloping involves filling inboard ditches with sidecast fill material and sloping the road surface to disperse water to the downhill side of the road. Some sidecast fill materials remain, but saturation and potential failure is reduced because water cannot concentrate in inboard ditches or on the road surface. The remaining fill slope materials may still cause stability problems, especially on steep slopes.

## **EC-1.2 CULVERT OUTLET ENERGY DISSIPATER**

### **DESCRIPTION**

An energy dissipater is a structure designed to control erosion at the outlet of a culvert or conduit by reducing the velocity of flow and dissipating the energy (see BMP SS-10 Outlet Protection/ Velocity Dissipation Devices).

### **LIMITATIONS**

- Do not use this BMP below the mean high water line of any water body before obtaining appropriate permits. Due to issues relative to Corps 404 jurisdiction sometimes energy dissipaters are not placed below the ordinary high water mark which results in increased erosion.
- Consider other energy dissipaters such as concrete impact basins, paved outlet structures, or a half culvert where site conditions warrant.
- Rock/riprap dissipaters may require containment in mattresses to maintain their effectiveness.

### **BEST MANAGEMENT PRACTICES**

- Size rock to handle high velocity storm events.
- Key rock into sides of fillslope to prevent undercutting (Figure 1).
- Best results are obtained when sound, durable, angular rock is used (Figure 2).
- Inspect after each significant rain for erosion and/or disruption of the rock, and repair immediately.

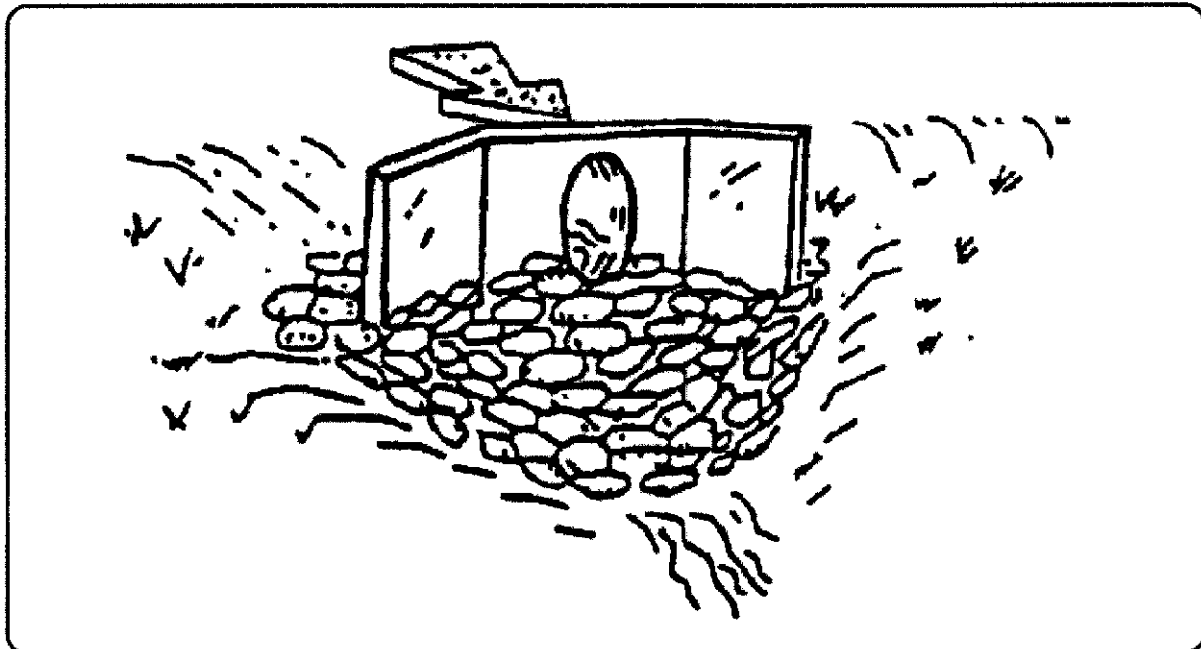

*Figure 1. Flared outlet with rock energy dissipater. From Weber County, UT.*

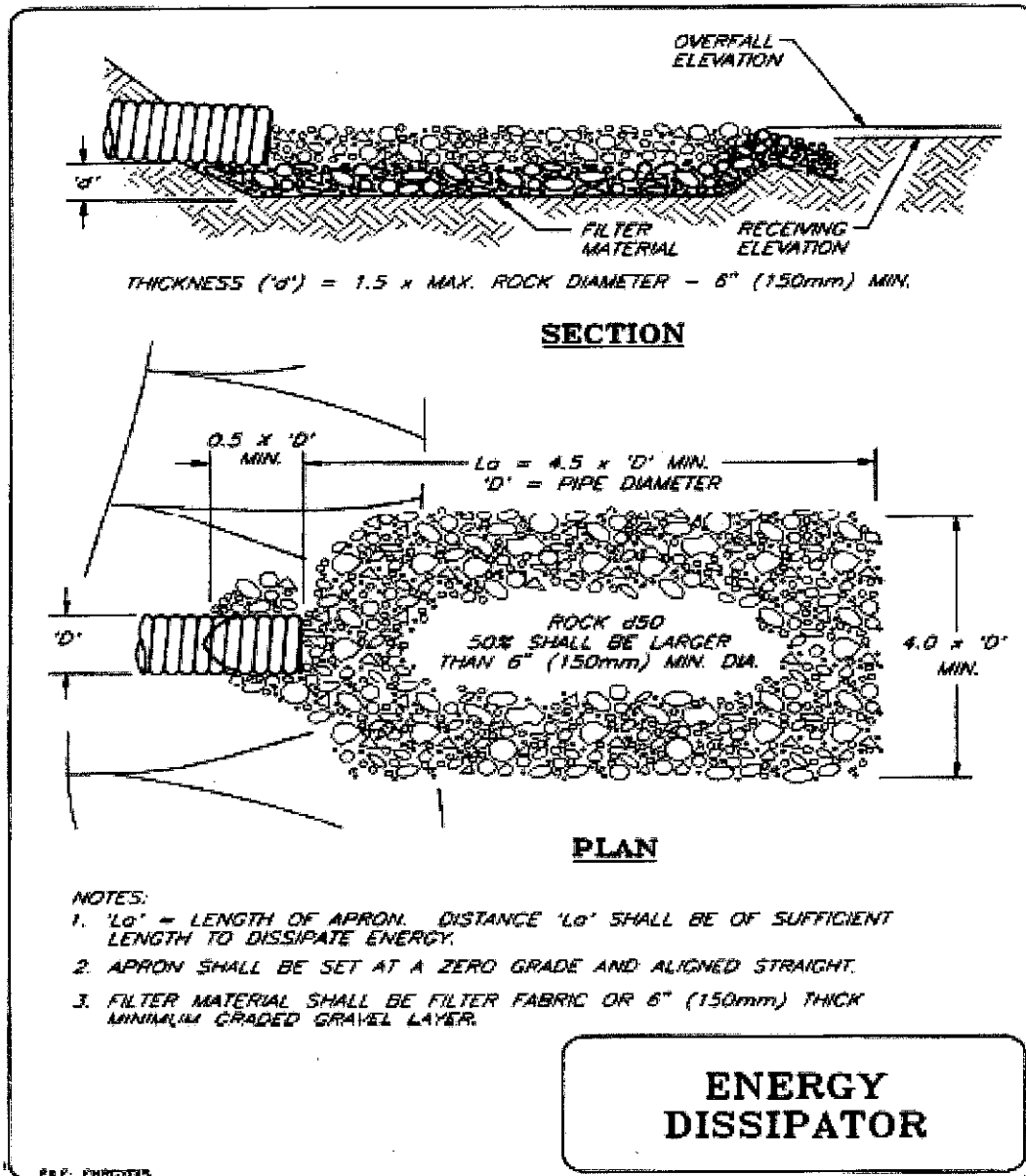

Figure 2. Rock energy dissipater. From 2004 Fishnet 4C. Adapted from 1994 McCullah.

**Source Material for Road BMP RD-2.12 Culvert Outlet Energy Dissipater**

2004. FishNet 4C. Guidelines for Protecting Aquatic Habitat and Salmon Fisheries for County Road Maintenance.

N/A. Weber County, Engineering Department. Ogden, Utah.

## **EC-1.3 OUTLET PROTECTION**

### **DESCRIPTION**

A rock outlet protection is a physical device composed of rock, riprap, grouted riprap, or concrete rubble which is placed at the outlet of a pipe to prevent scour of the soil caused by high pipe flow velocities, and to absorb flow energy to produce nonerosive velocities (see Construction BMP SS-10 Outlet Protection/ Velocity Dissipation Devices).

### **APPLICATIONS:**

- Wherever discharge velocities and energies at the outlets of culverts, conduits, or channels are sufficient to erode the next downstream reach.
- Rock outlet protection is best suited for temporary use during construction because it is usually less expensive and easier to install than concrete aprons or an energy dissipater (Figure 1) (see Erosion Control BMP EC-1.3 Energy Dissipater).
- A sediment trap below the pipe outlet is recommended if runoff is sediment laden (Figure 2).
- Permanent rock riprap protection should be designed and sized by the engineer as part of the culvert, conduit or channel design (Figure 2).
- Grouted riprap should be avoided in areas of freeze and thaw because the grout will break up.

### **LIMITATIONS**

- Large storms often wash away the rock outlet protection and leave the area susceptible to erosion.
- Sediment captured by the rock outlet protection may be difficult to remove without removing the rock.
- Outlet protection may negatively impact the channel habitat in streams.

### **BEST MANAGEMENT PRACTICES**

- Size rock to handle high velocity storm events (Figure 3).
- Key rock into sides of fillslope to prevent undercutting.
- Best results are obtained when sound, durable, angular rock is used.
- Inspect after each significant rain for erosion and/or disruption of the rock, and repair immediately.

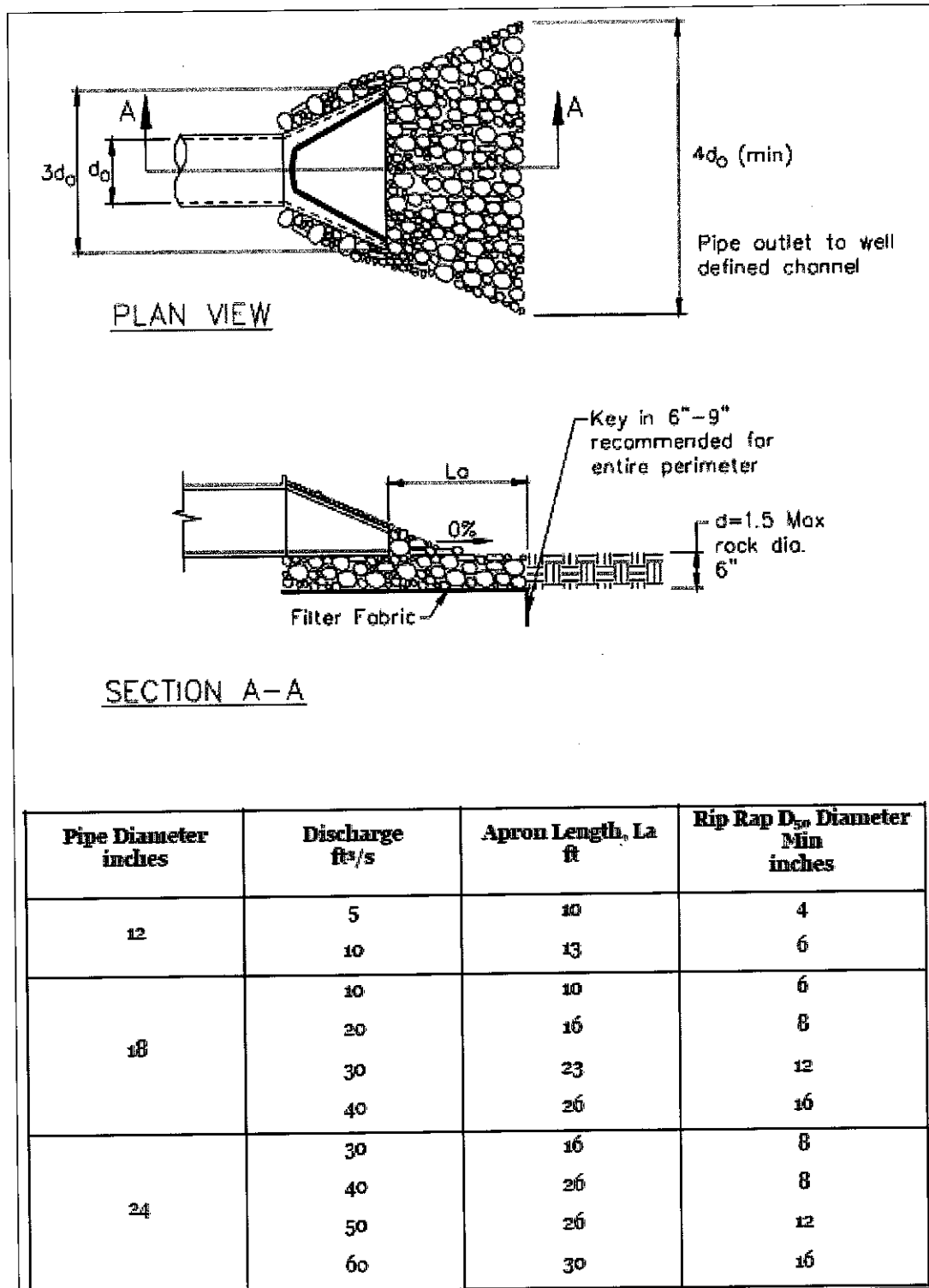

Figure 1. Flared outlet with energy dissipater. From Caltrans (2003). (Adapted from USDA-SCS).

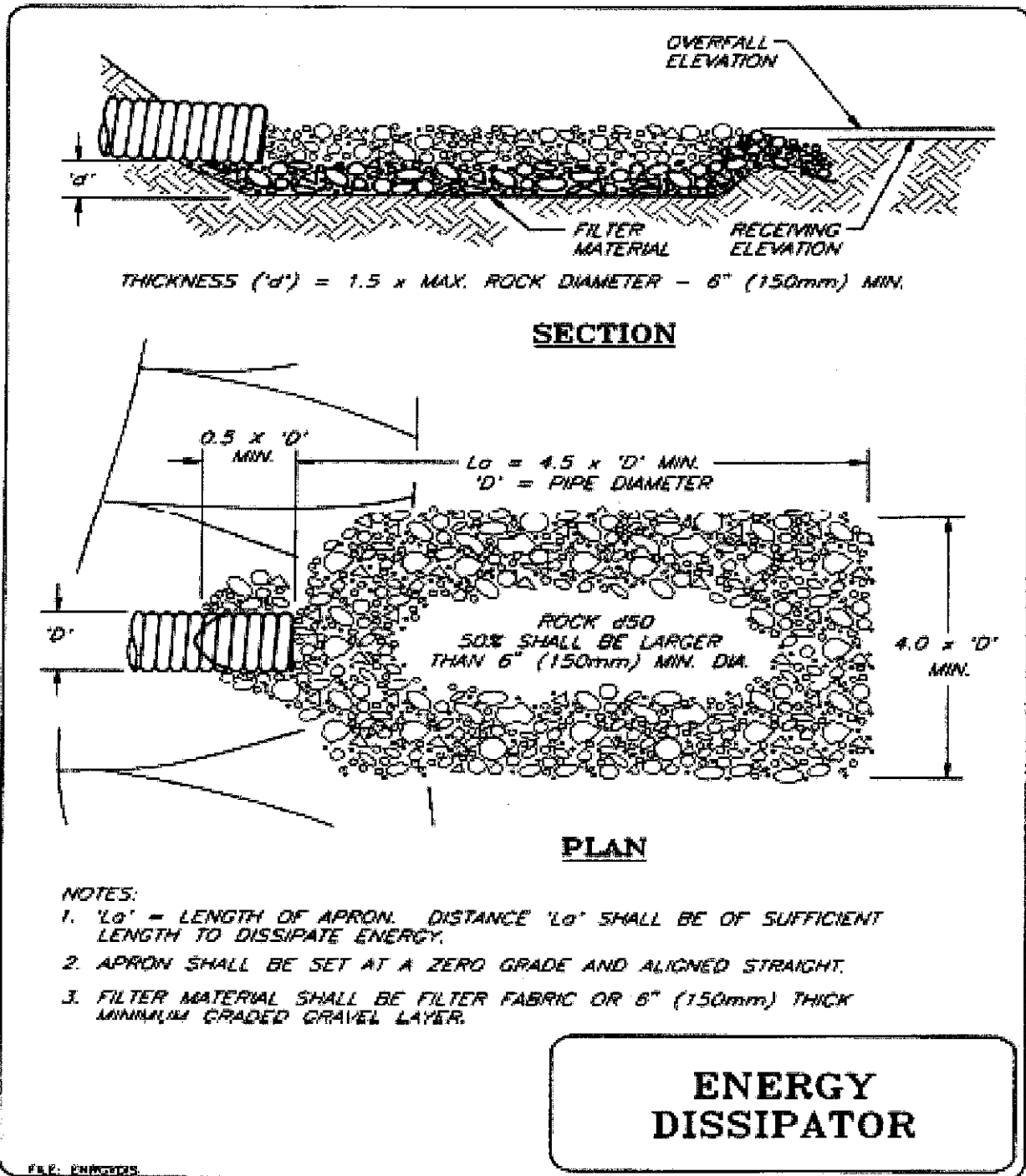
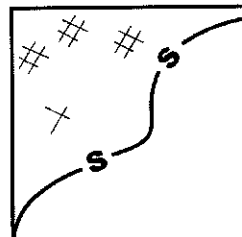
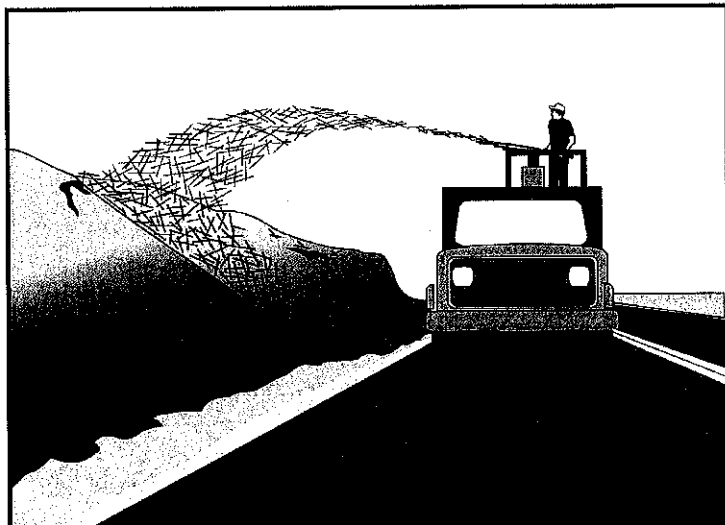

Figure 2. Rock energy dissipater. From 2004 Fishnet 4C. Adapted from 1994 McCullah.



# Straw Mulch

**SS-6**



Standard Symbol

- BMP Objectives**
- Soil Stabilization
  - Sediment Control
  - Tracking Control
  - Wind Erosion Control
  - Non-Storm Water Management
  - Materials and Waste Management

**Definition and Purpose** Straw mulch consists of placing a uniform layer of straw and incorporating it into the soil with a studded roller or anchoring it with a stabilizing emulsion. This is one of five temporary soil stabilization alternatives to consider.

- Appropriate Applications**
- Straw mulch is typically used for soil stabilization as a temporary surface cover on disturbed areas until soils can be prepared for revegetation and permanent vegetation is established.
  - Also typically used in combination with temporary and/or permanent seeding strategies to enhance plant establishment.

- Limitations**
- Availability of erosion control contractors and straw may be limited prior to the rainy season due to high demand.
  - There is a potential for introduction of weed-seed and unwanted plant material.
  - When straw blowers are used to apply straw mulch, the treatment areas must be within 45 m (150 ft) of a road or surface capable of supporting trucks.
  - Straw mulch applied by hand is more time intensive and potentially costly.
  - May have to be removed prior to permanent seeding or soil stabilization.
  - “Punching” of straw does not work in sandy soils.

## Straw Mulch

**SS-6**

- Standards and Specifications
- Straw shall be derived from wheat, rice, or barley.
  - All materials shall conform to Standard Specifications Sections 20-2.06, 20-2.07 and 20-2.11.
  - A tackifier is the preferred method for anchoring straw mulch to the soil on slopes.
  - Crimping, punch roller-type rollers, or track-walking may also be used to incorporate straw mulch into the soil on slopes. Track walking shall only be used where other methods are impractical.
  - Avoid placing straw onto the traveled way, sidewalks, lined drainage channels, sound walls, and existing vegetation.
  - Straw mulch with tackifier shall not be applied during or immediately before rainfall.

### ***Application Procedures***

- Apply loose straw at a minimum rate of 3,570 kg/ha (4,000 lb/ac), or as indicated in the project's special provisions, either by machine or by hand distribution.
- If stabilizing emulsion will be used to anchor the straw mulch in lieu of incorporation, roughen embankment or fill areas by rolling with a crimping or punching-type roller or by track walking before placing the straw mulch. Track walking should only be used where rolling is impractical.
- The straw mulch must be evenly distributed on the soil surface.
- Anchor the mulch in place by using a tackifier or by "punching" it into the soil mechanically (incorporating).
- A tackifier acts to glue the straw fibers together and to the soil surface. The tackifier shall be selected based on longevity and ability to hold the fibers in place.
- A tackifier is typically applied at a rate of 140 kg/ha (125 lb/ac). In windy conditions, the rates are typically 200 kg/ha (178 lb/ac).
- Methods for holding the straw mulch in place depend upon the slope steepness, accessibility, soil conditions and longevity. If the selected method is incorporation of straw mulch into the soil, then do as follows:
  - Applying and incorporating straw shall follow the requirements in Standard Specifications Section 20-3.03.
  - On small areas, a spade or shovel can be used.

## Straw Mulch

---

**SS-6**

- On slopes with soils, which are stable enough and of sufficient gradient to safely support construction equipment without contributing to compaction and instability problems, straw can be “punched” into the ground using a knife-blade roller or a straight bladed coultter, known commercially as a “crimper.”
  - On small areas and/or steep slopes, straw can also be held in place using plastic netting or jute. The netting shall be held in place using 11 gauge wire staples, geotextile pins or wooden stakes. Refer to BMP SS-7, “Geotextiles, Plastic Covers and Erosion Control Blankets/Mats.”
- Maintenance and Inspections
- The key consideration in Maintenance and Inspection is that the straw needs to last long enough to achieve erosion control objectives.
  - Maintain an unbroken, temporary mulched ground cover while DSAs are non-active. Repair any damaged ground cover and re-mulch exposed areas.
  - Reapplication of straw mulch and tackifier may be required by the Resident Engineer (RE) to maintain effective soil stabilization over disturbed areas and slopes.
  - After any rainfall event, the Contractor is responsible for maintaining all slopes to prevent erosion.

**Source Material for Construction BMP SS-6**

**2003. State of California Department of Transportation. Caltrans Storm Water Quality Handbook Construction Site BMP Manual.**

## Geotextiles, Mats, Plastic Covers and Erosion Control Blankets

**SS-7**

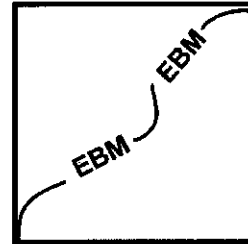
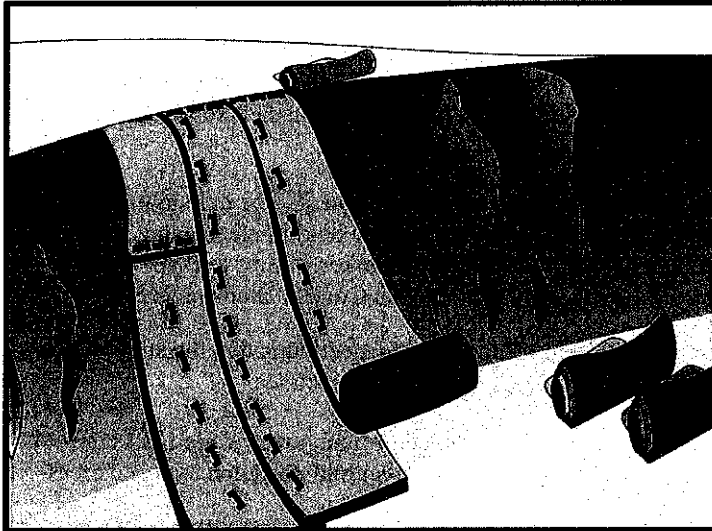

Standard Symbol

### BMP Objectives

- Soil Stabilization
- Sediment Control
- Tracking Control
- Wind Erosion Control
- Non-Storm Water Management
- Materials and Waste Management

**Definition and Purpose** This Best Management Practice (BMP) involves the placement of geotextiles, mats, plastic covers, or erosion control blankets to stabilize disturbed soil areas and protect soils from erosion by wind or water. This is one of five temporary soil stabilization alternatives to consider.

**Appropriate Applications** These measures are used when disturbed soils may be particularly difficult to stabilize, including the following situations:

- Steep slopes, generally steeper than 1:3 (V:H).
- Slopes where the erosion potential is high.
- Slopes and disturbed soils where mulch must be anchored.
- Disturbed areas where plants are slow to develop.
- Channels with flows exceeding 1.0 m/s (3.3 ft/s).
- Channels to be vegetated.
- Stockpiles.
- Slopes adjacent to water bodies of Environmentally Sensitive Areas (ESAs).

## **Geotextiles, Mats, Plastic Covers and Erosion Control Blankets**

---

**SS-7**

- Limitations**
- Blankets and mats are more expensive than other erosion control measures, due to labor and material costs. This usually limits their application to areas inaccessible to hydraulic equipment, or where other measures are not applicable, such as channels.
  - Blankets and mats are generally not suitable for excessively rocky sites, or areas where the final vegetation will be mowed (since staples and netting can catch in mowers).
  - Blankets and mats must be removed and disposed of prior to application of permanent soil stabilization measures.
  - Plastic sheeting is easily vandalized, easily torn, photodegradable, and must be disposed of at a landfill.
  - Plastic results in 100% runoff, which may cause serious erosion problems in the areas receiving the increased flow.
  - The use of plastic shall be limited to covering stockpiles, or very small graded areas for short periods of time (such as through one imminent storm event), until alternative measures, such as seeding and mulching, may be installed.
  - Geotextiles, mats, plastic covers, and erosion control covers have maximum flow rate limitations; consult the manufacturer for proper selection.

**Standards and  
Specifications**

***Material Selection***

There are many types of erosion control blankets and mats, and selection of the appropriate type shall be based on the specific type of application and site conditions. Selection(s) made by the Contractor must be approved by the Resident Engineer (RE); certification of compliance shall be in accordance with Standard Specifications Section 6-1.07.

***Site Preparation***

- Proper site preparation is essential to ensure complete contact of the blanket or matting with the soil.
- Grade and shape the area of installation.
- Remove all rocks, clods, vegetation or other obstructions so that the installed blankets or mats will have complete, direct contact with the soil.
- Prepare seedbed by loosening 50 mm (2 in) to 75 mm (3 in) of topsoil.

***Seeding***

Seed the area before blanket installation for erosion control and revegetation. Seeding after mat installation is often specified for turf reinforcement application. When seeding prior to blanket installation, all check slots and other areas disturbed during installation must be re-seeded. Where soil filling is specified, seed the matting and the entire disturbed area after installation and prior to filling the mat with soil.

# SC-1.1 CHECK DAMS

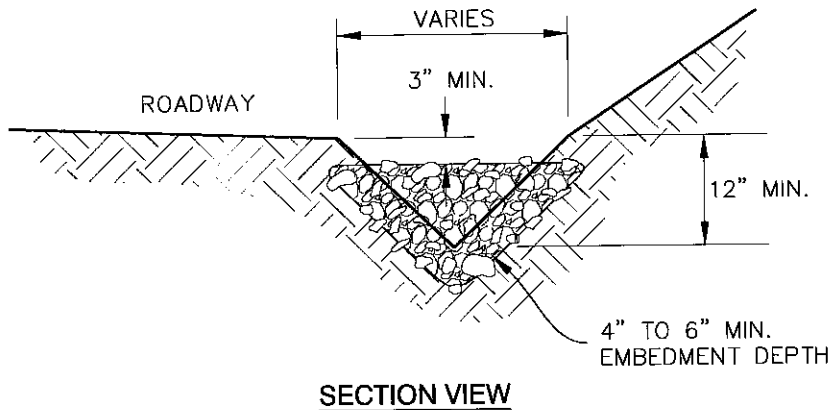

## CHECK DAMS:

1. CHECK DAMS SHALL BE INSTALLED AT ALL LOCATIONS INDICATED ON THE WRPP, AND AT ANY OTHER LOCATION DEEMED NECESSARY BY THE SITE CONTRACTOR.
2. CHECK DAMS SHOULD BE SPACED SO THAT THE TOE OF CHECK DAM IS THE SAME ELEVATION AS THE TOP OF THE CHECK DAM BELOW.
3. CHECK DAMS SHOULD BE IMBEDDED IN CHANNEL A MINIMUM OF 4"-6"
4. CHECK DAMS THAT EXCEED A HEIGHT OF 3' SHOULD BE DESIGNED BY A QUALIFIED ENGINEER, GEOLOGIST, OR EROSION CONTROL SPECIALIST.
5. CHECK DAMS SHALL BE INSPECTED PERIODICALLY THROUGHOUT THE COURSE OF CONSTRUCTION, ONCE AFTER EACH RAINFALL EVENT, AND ONCE EVERY 24 HOURS DURING EXTENDED RAINFALL EVENTS. ANY SPLIT, TORN, UNRAVELED OR SLUMPING FIBER ROLLS SHALL BE REPAIRED OR REPLACED IMMEDIATELY.

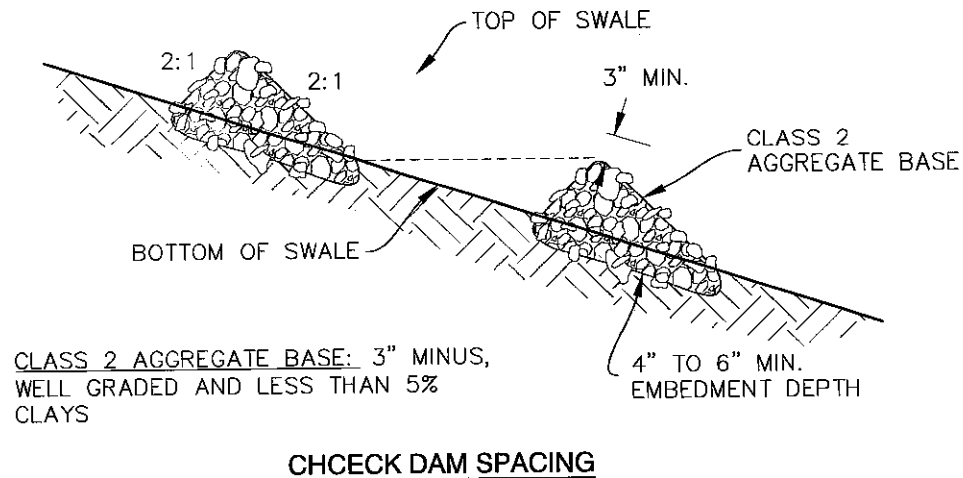

# SC1.2 TEMPORARY SEDIMENT BASIN

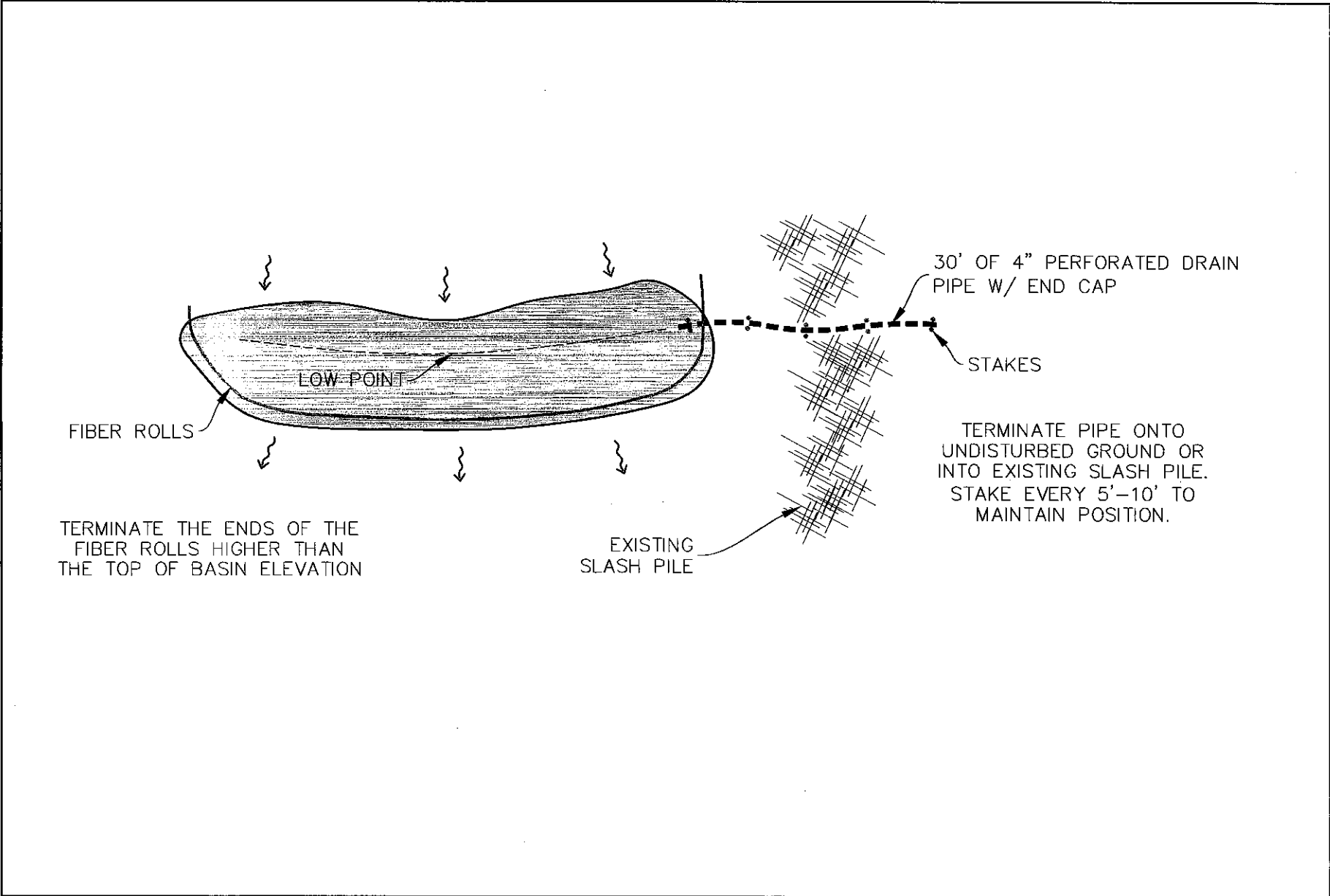

# SC-1.3 FIBER ROLLS

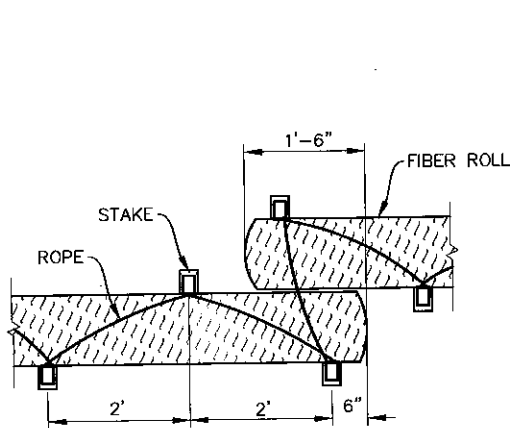

PLAN VIEW

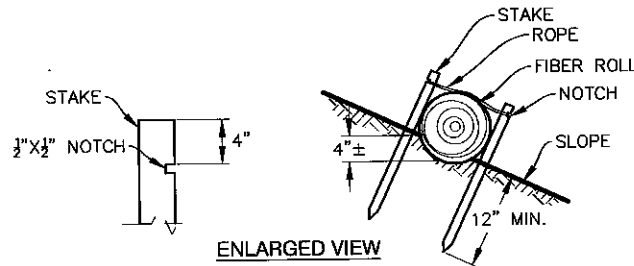

ENLARGED VIEW

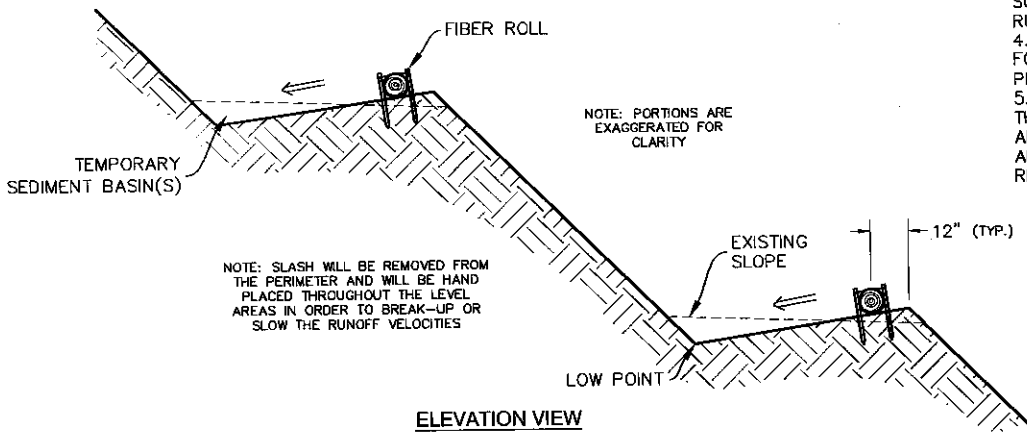

NOTE: SLASH WILL BE REMOVED FROM THE PERIMETER AND WILL BE HAND PLACED THROUGHOUT THE LEVEL AREAS IN ORDER TO BREAK-UP OR SLOW THE RUNOFF VELOCITIES

NOTE: PORTIONS ARE EXAGGERATED FOR CLARITY

ELEVATION VIEW

## FIBER ROLLS:

1. FIBER ROLLS SHALL BE INSTALLED AT ALL LOCATIONS INDICATED ON THE WRPP, AND AT ANY OTHER LOCATION DEEMED NECESSARY BY THE SITE CONTRACTOR.
2. FIBER ROLLS SHOULD BE USED ALONG THE FACE OF EXPOSED SLOPES TO SHORTEN SLOPE LENGTH AND DECREASE FLOW VELOCITY; AT GRADE BREAKS WHERE SLOPES TRANSITION TO STEEPER SLOPES; AND ALONG STREAM BANKS TO ASSIST STABILIZATION, AND IN DRAINAGE SWALES TO SLOW FLOWS. ON 1:1 SLOPES PLACE FIBER ROLLS SPACED AT 10' INTERVALS PARALLEL TO SLOPE, ON 1.5:1 SLOPES PLACE FIBER ROLLS SPACED AT 15' INTERVALS PARALLEL TO SLOPE, AND ON 2:1 SLOPES PLACE FIBER ROLLS SPACED AT 20' INTERVALS PARALLEL TO SLOPE.
3. FIBER ROLLS SHALL CONSIST OF BIODEGRADABLE FIBERS STUFFED INTO A PHOTO-DEGRADABLE OPEN WEAVE NETTING. THEY SHALL BE DESIGNED TO ALLOW WATER TO PASS THROUGH THE FIBERS; TO TRAP SUSPENDED SEDIMENT; INCREASE FILTRATION RATES; AND TO SLOW RUNOFF.
4. FIBER ROLLS SHALL BE PLACED SUCH THAT THEY OVERLAP AND FOLLOW THE CONTOUR LINES OF THE SLOPE ON WHICH THEY ARE PLACED.
5. FIBER ROLLS SHALL BE INSPECTED PERIODICALLY THROUGHOUT THE COURSE OF CONSTRUCTION, ONCE AFTER EACH RAINFALL EVENT, AND ONCE EVERY 24 HOURS DURING EXTENDED RAINFALL EVENTS. ANY SPLIT, TORN, UNRAVELED OR SLUMPING FIBER ROLLS SHALL BE REPAIRED OR REPLACED IMMEDIATELY.



## **ROAD BMP RESOURCES**

### **DESCRIPTION**

Listed below are some of the resource materials for Road BMPs that are available for landowners.

**2006. California Department of Fish and Game. Part X - Upslope Erosion Inventory and Sediment Control Guidance, California Salmonid Stream Habitat Restoration Manual.**

Available at:

California Department of Fish and Game  
Inland Fisheries Division  
ATTN: Salmonid Habitat Restoration Coordinator  
1416 Ninth Street, Sacramento, CA 95814 (916) 654-5997  
or  
[www.dfg.ca.gov/fish/resources/habitatmanual.asp](http://www.dfg.ca.gov/fish/resources/habitatmanual.asp)

**2003. California Department of Transportation (CALTRANS). Storm Water Quality Handbooks – Construction Site Best Management Practices (BMPs) Manual.**

Available at:

[www.dot.ca.gov/hq/construc/stormwater/CSBMPPM\\_303\\_Final.pdf](http://www.dot.ca.gov/hq/construc/stormwater/CSBMPPM_303_Final.pdf)

**2009. California Stormwater Quality Association (CASQA). California Stormwater BMP Handbook.**

Available at:

California Stormwater Quality Association  
PO Box 2105  
Menlo Park, CA 94026  
or  
[www.cabmphandbooks.com](http://www.cabmphandbooks.com)

**2004. FishNet 4C. Guidelines for Protecting Aquatic Habitat and Salmon Fisheries for County Road Maintenance.**

Available at:

3820 Cypress Dr., Suite 11  
Petaluma, CA 94954 Phone: 707.762.1336  
or  
[http://fishnet.marin.org/projects\\_roads\\_manual.html](http://fishnet.marin.org/projects_roads_manual.html)

**2002. Five Counties Salmon Conservation Program. A Water Quality and Stream Habitat Protection Manual for County Road Maintenance.**

Available at:

[www.5counties.org/Projects/FinalGeneralProjectPages/RoadsManual800.htm](http://www.5counties.org/Projects/FinalGeneralProjectPages/RoadsManual800.htm)

**1996. US Forest Service. A Guide for Road Closure and Obliteration In the Forest Service. Technology and Development Program. Publication: 9677 1205.**

Available at:

[www.fs.fed.us/eng/pubs/pdfimage/96771205.pdf](http://www.fs.fed.us/eng/pubs/pdfimage/96771205.pdf)

**2014. Weaver W.E., Wepner E. and Hagans D.K. Handbook for Forest, Ranch, and Rural Roads. Mendocino County Resource Conservation District.**

Available at:

Mendocino County Resource Conservation District  
404 Orchard Avenue, Ukiah, CA 95482 (707) 468-9223

Or

[http://mercd.org/wp-content/uploads/Handbook\\_for\\_Forest\\_Ranch&Rural\\_Roads.pdf](http://mercd.org/wp-content/uploads/Handbook_for_Forest_Ranch&Rural_Roads.pdf)

# SITE MANAGEMENT PLAN - APPENDIX C - WATER DIVERSION AND USE RECORDS



## Yearly Monitoring Reporting

### Water Diversion, Storage, and Use

<b>Organization/Name:</b>	Journey Aquarian - RANCH parcel
<b>APN:</b>	216-081-013

#### Total surface water diversion by source and month (gallons or acre-feet)

Source	Jan	Feb	March	April	May	June	July	Aug	Sept	Oct	Nov	Dec	Total
Spring near Pond 4 (POD-4)													-
Spring near Pond 3 (POD-3)													-
													-
<b>Total</b>													-

#### Surface Water input to storage by source and month (gallons or acre-feet)

Storage - Source	Jan	Feb	March	April	May	June	July	Aug	Sept	Oct	Nov	Dec	Total
Proposed Pond 5 - Cultivation*													-
Tanks and Bladders - Cultivation													-
Pond 2 (40,000-gallon capacity) - Cultivation*													-
Pond 3 (35,000-gallon capacity) - Cultivation*													-
													-
<b>Total</b>													-

#### Water use by source and month (gallon or acre-feet)

Use-Source	Jan	Feb	March	April	May	June	July	Aug	Sept	Oct	Nov	Dec	Total
Storage: Proposed Pond 5 - Cultivation													-
Storage: Tanks and Bladders - Cultivation (95,000-gallons)													-
Storage: Pond 2 (40,000-gallon capacity)													-
Storage: Pond 3 (35,000-gallon capacity)													-
Direct Diversion: Domestic (from POD-3)													-
Direct Diversion: Cultivation (from POD-4)													-
<b>Total</b>													-

\*If necessary to fill rainwater catchment ponds

# SITE MANAGEMENT PLAN - APPENDIX C - WATER DIVERSION AND USE RECORDS



## Yearly Monitoring Reporting

### Water Diversion, Storage, and Use

<b>Organization/Name:</b>	Journey Aquarian - POND parcel
<b>APN:</b>	216-134-004, 216-135-008

#### Total surface water diversion by source and month (gallons or acre-feet)

Source	Jan	Feb	March	April	May	June	July	Aug	Sept	Oct	Nov	Dec	Total
Pond 1* - Cultivation													-
Spring** - Domestic (seasonal)													-
													-
<b>Total</b>													-

#### Surface Water input to storage by source and month (gallons or acre-feet)

Storage - Source	Jan	Feb	March	April	May	June	July	Aug	Sept	Oct	Nov	Dec	Total
Proposed Pond 6 - Cultivation***													-
Tanks - Cultivation													-
													-
													-
<b>Total</b>													-

#### Water use by source and month (gallon or acre-feet)

Use-Source	Jan	Feb	March	April	May	June	July	Aug	Sept	Oct	Nov	Dec	Total
Direct Diversion - Cultivation													-
Storage (Pond & Tanks) - Cultivation													-
Direct Diversion - Domestic													-
													-
<b>Total</b>													-

