

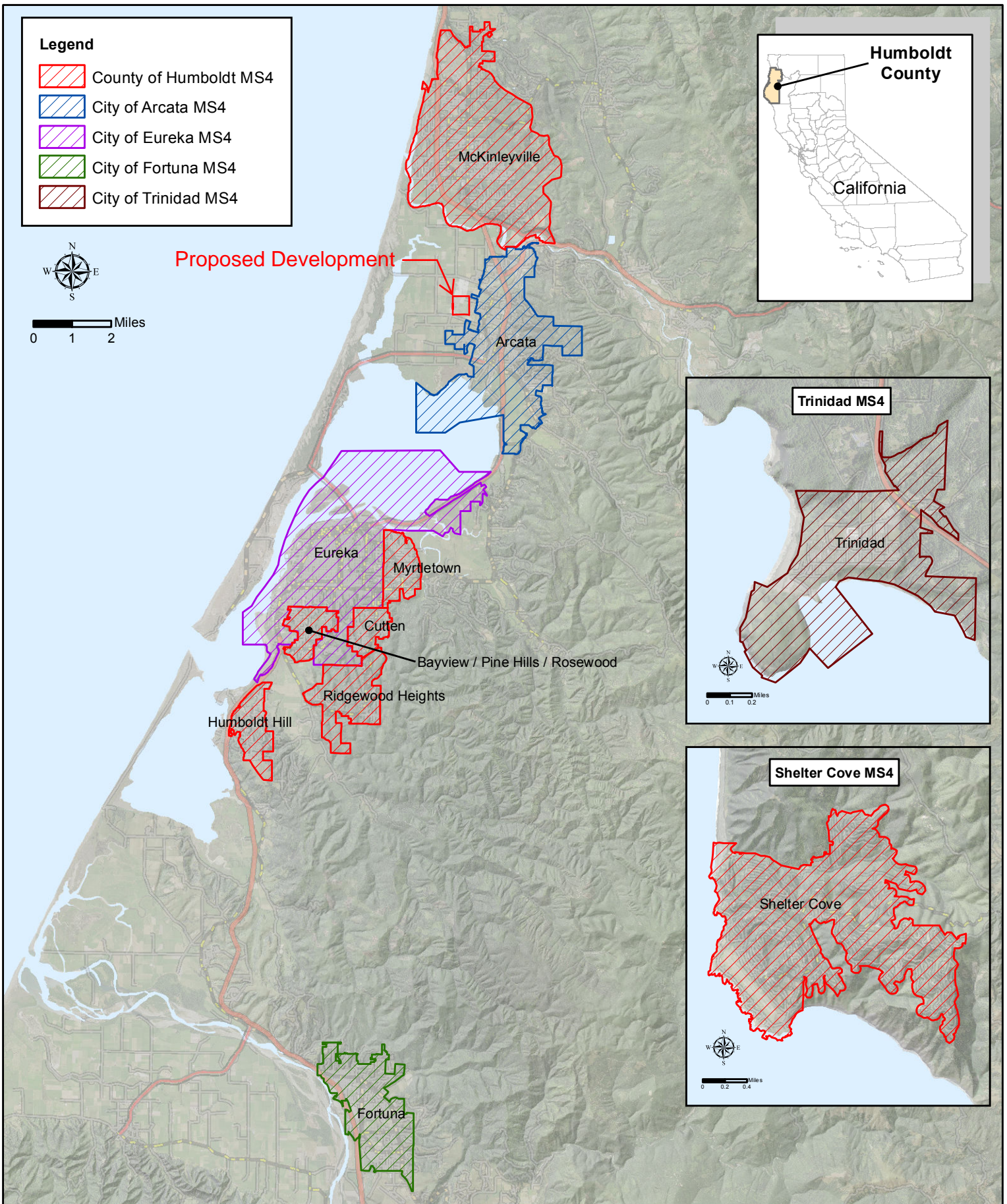

**APPENDIX A
HUMBOLDT COUNTY MS4 PHASE II
PERMIT BOUNDARY MAP**



Humboldt LID Stormwater Manual - MS4 Boundary Areas Map

This map is intended for planning purposes and should not be used for precise measurement or navigation. All locations are approximate.

Imagery: USDA NAIP (2014)
Map Prepared: May 2016





**APPENDIX B
WATER BALANCE SUMMARY**

Post-Construction Water Balance Calculator



<p>User may make changes from any cell that is orange or brown in color (similar to the cells to the immediate right). Cells in green are calculated for you.</p>		<p>(Step 1a) If you know the 85th percentile storm event for your location enter it in the box below</p>	<p>(Step 1b) If you can not answer 1a then select the county where the project is located (click on the cell to the right for drop-down): This will determine the average 85th percentile 24 hr. storm event for your site, which will appear under precipitation to left.</p>	<p>HUMBOLDT</p>
		<p>0.65</p>	<p>(Step 1c) If you would like a more precise value select the location closest to your site. If you do not recognize any of these locations, leave this drop-down menu at location. The average value for the County will be used.</p>	<p>EUREKA WFO WOODLEY IS</p>
Project Information		Runoff Calculations		
<p>Project Name:</p>	<p>Arcata Land Company LLC Site Improvements</p>	<p>(Step 2) Indicate the Soil Type (dropdown menu to right):</p>	<p>Group C Soils</p>	<p>Low infiltration. Sandy clay loam. Infiltration rate 0.05 to 0.15 inch/hr when wet.</p>
<p>Waste Discharge Identification (WDID):</p>		<p>(Step 3) Indicate the existing dominant non-built land Use Type (dropdown menu to right):</p>	<p>Cultivated Agricultural: minor crop residue cover</p>	
<p>Date:</p>	<p>Optional</p>	<p>(Step 4) Indicate the proposed dominant non-built land Use Type (dropdown menu to right):</p>	<p>Natural Desert Landscape</p>	
<p>Sub Drainage Area Name (from map):</p>	<p>Optional</p>		<p>Complete Either</p>	
Runoff Curve Numbers			<p>Sq Ft</p>	<p>Acres</p>
<p>Existing Pervious Runoff Curve Number</p>	<p>90</p>	<p>(Step 5) Total Project Site Area:</p>	<p>31.50</p>	<p>31.50</p>
<p>Proposed Development Pervious Runoff Curve Number</p>	<p>94</p>	<p>(Step 6) Sub-watershed Area:</p>	<p>31.50</p>	<p>31.50</p>
Design Storm		<p>Percent of total project :</p>	<p>100%</p>	
<p>Based on the County you indicated above, we have included the 85 percentile average 24 hr event - P85 (in)^h for your area.</p>	<p>0.65</p>	<p>in</p>		
<p>The Amount of rainfall needed for runoff to occur (Existing runoff curve number -P from existing RCN (in)^h)</p>	<p>0.22</p>	<p>In</p>		
<p>P used for calculations (in) (the greater of the above two criteria)</p>	<p>0.65</p>	<p>In</p>		
<p>*Available at www.cabmphandbooks.com</p>				
			<p>(Step 7) Sub-watershed Conditions</p>	<p>Complete Either</p>
			<p>Sub-watershed Area (acres)</p>	<p>Calculated Acres</p>
			<p>Existing Rooftop Impervious Coverage</p>	<p>0</p>
			<p>Existing Non-Rooftop Impervious Coverage</p>	<p>7.6</p>
			<p>Proposed Rooftop Impervious Coverage</p>	<p>1.75</p>
			<p>Proposed Non-Rooftop Impervious Coverage</p>	<p>20.4</p>
			Credits	Acres
			<p>Porous Pavement</p>	<p>0</p>
			<p>Tree Planting</p>	<p>0</p>
			<p>Downspout Disconnection</p>	<p>0</p>
			<p>Impervious Area Disconnection</p>	<p>19.58</p>
			<p>Green Roof</p>	<p>0</p>
			<p>Stream Buffer</p>	<p>0</p>
			<p>Vegetated Swales</p>	<p>0</p>
			<p>Subtotal</p>	<p>19.58</p>
			<p>37309 Cu. Ft.</p>	
			<p>Subtotal Runoff Volume Reduction Credit</p>	
<p>You have achieved your minimum requirements</p>			<p>(Step 9) Impervious Volume Reduction Credits</p>	
			<p>Volume (cubic feet)</p>	
			<p>Cu. Ft.</p>	<p>0</p>
			<p>Rain Barrels/Cisterns</p>	<p>15,821 Cu. Ft.</p>
			<p>Soil Quality</p>	<p>0</p>
			<p>15,821 Cu. Ft.</p>	
			<p>Subtotal Runoff Volume Reduction Credit</p>	
			<p>53,130 Cu. Ft.</p>	
			<p>Total Runoff Volume Reduction Credit</p>	

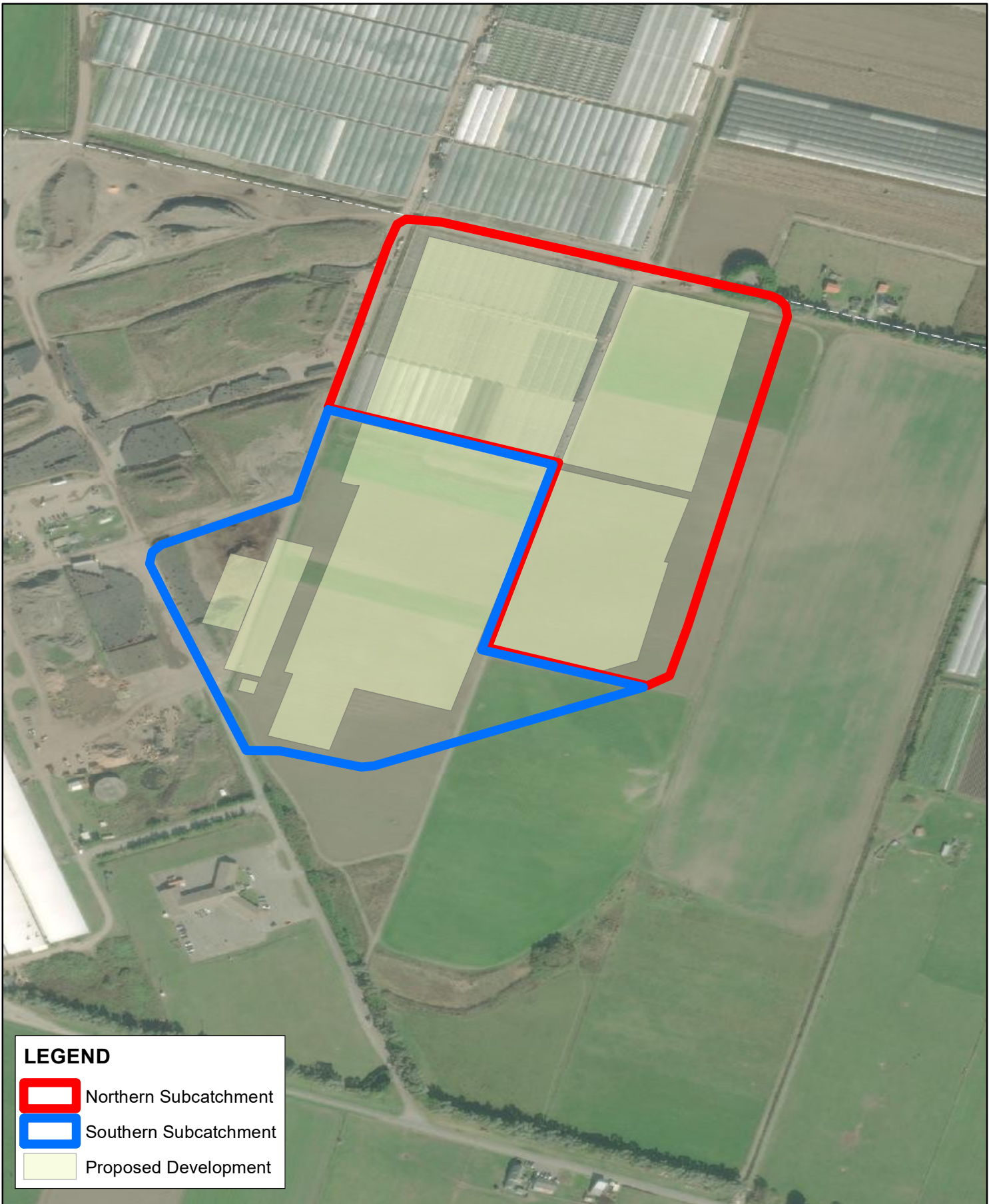

APPENDIX C SUBCATCHMENT DELINEATION AND HYDROLOGY



LEGEND

-  Northern Subcatchment
-  Southern Subcatchment
-  Proposed Development



CIVIL ENGINEERING
 CONSTRUCTION MANAGEMENT
 LANDSCAPE ARCHITECTURE
 MECHANICAL ENGINEERING
 PLANNING
 PUBLIC WORKS ADMINISTRATION
 SURVEYING/GIS SOLUTIONS
 WATER RESOURCES
 WALLACE SWANSON INTERNATIONAL
612 CLARION COURT
SAN LUIS OBISPO, CA 93401
T 805 544-4011 F 805 544-4294
www.wallacegroup.us

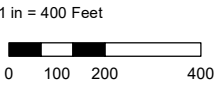

Subcatchment Delineation
Arcata Land Company LLC

JOB NO: 1595-0001
 MAP DOC: SUBCATCHMENT DELINEATION.MXD
 CREATED BY: DJG
 DATE: 09/23/2020

EXHIBIT NOTES:
 WALLACE GROUP DID
 NOT PERFORM SURVEY
 SERVICES FOR THIS MAP.
 NOT A LEGAL DOCUMENT.

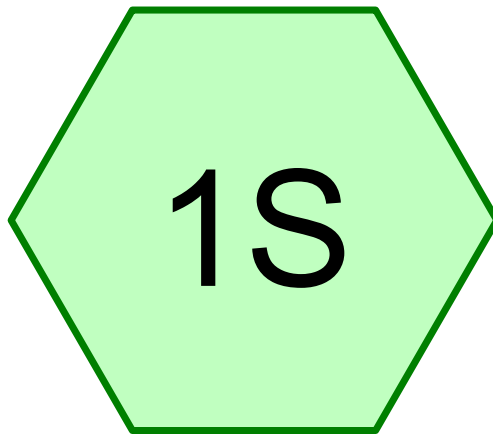

Existing Land

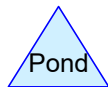
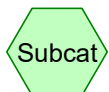

Runoff_Estimate_Existing

Prepared by Wallace Group

HydroCAD® 10.00-26 s/n 05444 © 2020 HydroCAD Software Solutions LLC

Printed 9/23/2020

Page 3

Area Listing (selected nodes)

Area (acres)	CN	Description (subcatchment-numbers)
0.165	91	Gravel Access Road (1S)
29.835	84	Pasture/grassland/range, Fair, HSG D (1S)
30.000	84	TOTAL AREA

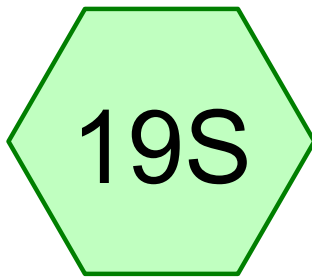

North Drainage Area

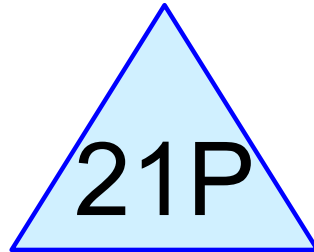
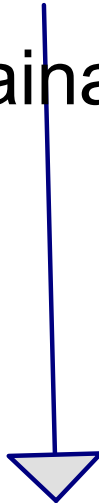

N Detention Pond

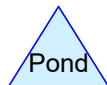
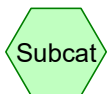

Runoff_Estimate_Proposed_Rev3

Prepared by Wallace Group

HydroCAD® 10.00-26 s/n 05444 © 2020 HydroCAD Software Solutions LLC

Printed 9/23/2020

Page 2

Area Listing (selected nodes)

Area (acres)	CN	Description (subcatchment-numbers)
0.250	98	Concrete (impermeable) (19S)
0.200	89	Gravel Road (CN from table) (19S)
1.040	91	Gravel Rows (CN approximates native soil to account for infiltration) (19S)
12.490	98	Hoop Houses (impermeable) (19S)
4.000	91	Open Space (19S)
17.980	96	TOTAL AREA

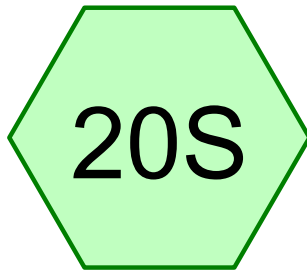

South Drainage Area



S Detention Pond

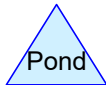
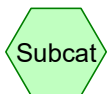

Runoff_Estimate_Proposed_Rev3

Prepared by Wallace Group

HydroCAD® 10.00-26 s/n 05444 © 2020 HydroCAD Software Solutions LLC

Printed 9/23/2020

Page 2

Area Listing (selected nodes)

Area (acres)	CN	Description (subcatchment-numbers)
0.540	98	Concrete (impermeable) (20S)
0.190	89	Gravel Road (20S)
0.610	91	Gravel Rows (CN approximates native soil to account for infiltration) (20S)
7.090	98	Hoop Houses (impermeable) (20S)
1.740	98	Office Building (20S)
1.850	91	Open Space (20S)
12.020	96	TOTAL AREA



APPENDIX D
HOOP HOUSE AND GRAVEL TRENCH DETAIL

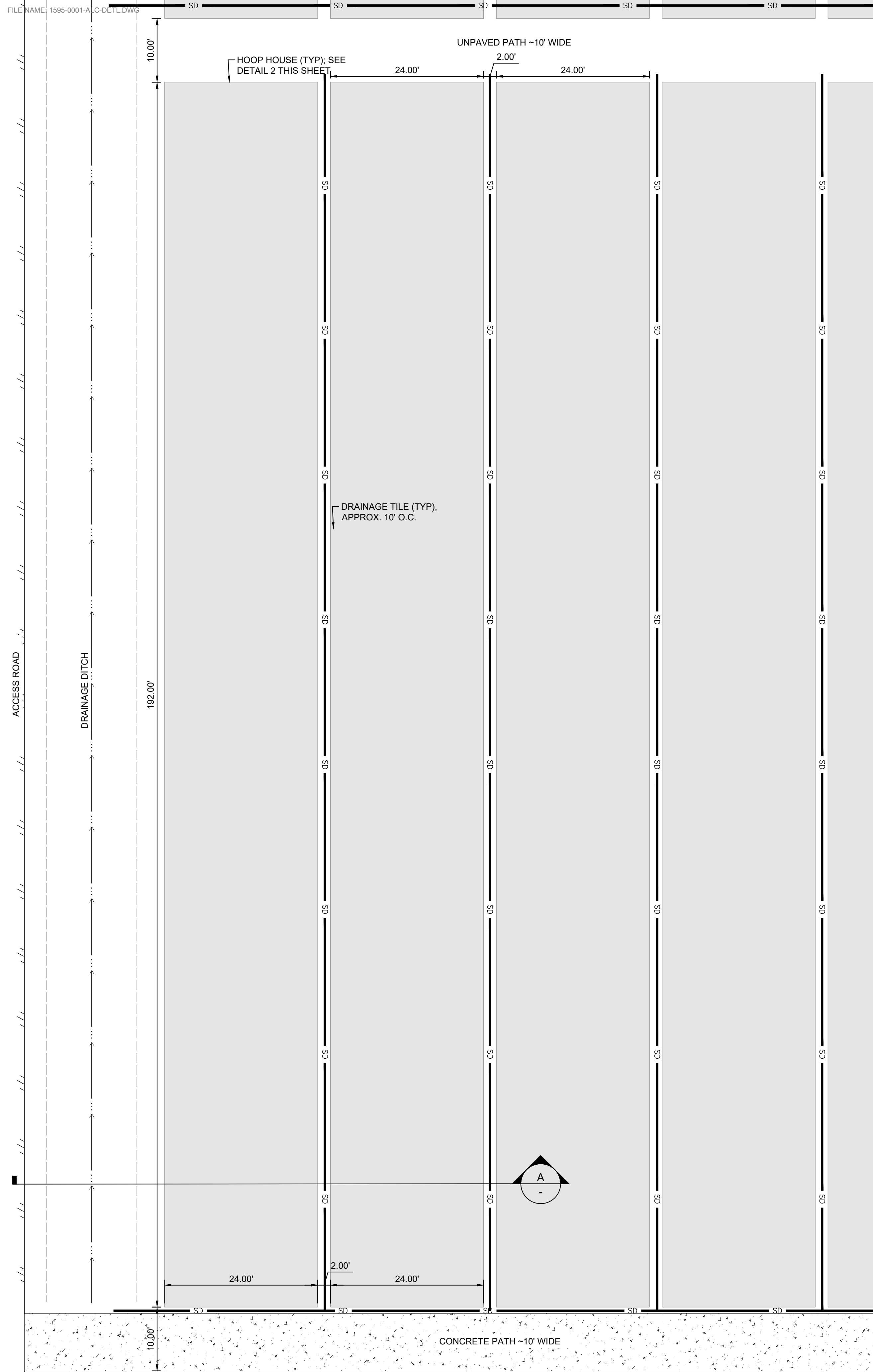

1 EXISTING HOOP HOUSE AND SUBDRAIN LAYOUT
Scale: 1:10

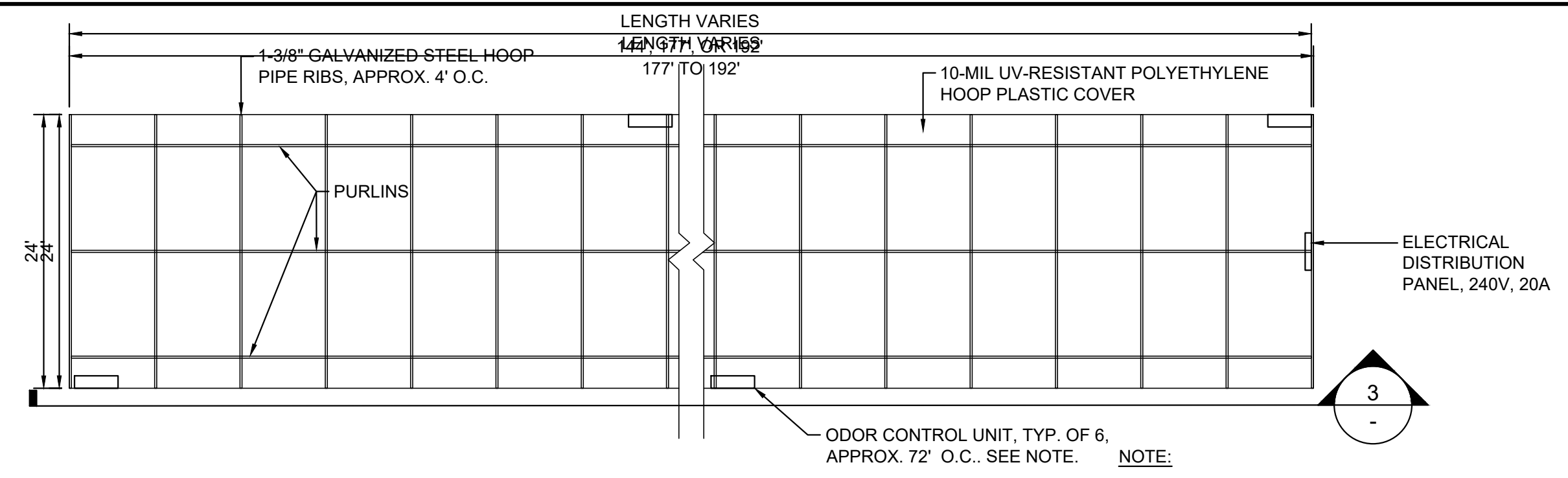

2 PROPOSED HOOP DETAIL - PLAN
Scale: NTS

- NOTE:
- ODOR CONTROL SHALL BE PROVIDED THROUGH CARBON BASED AIR FILTERS. HOOP HOUSE AIR VOLUME RANGES FROM 37,200 TO 49,500 CF. ODOR FLOW CONTROL UNITS SHALL BE SIZED TO TREAT A TOTAL OF 3 AIR VOLUMES PER HOUR.

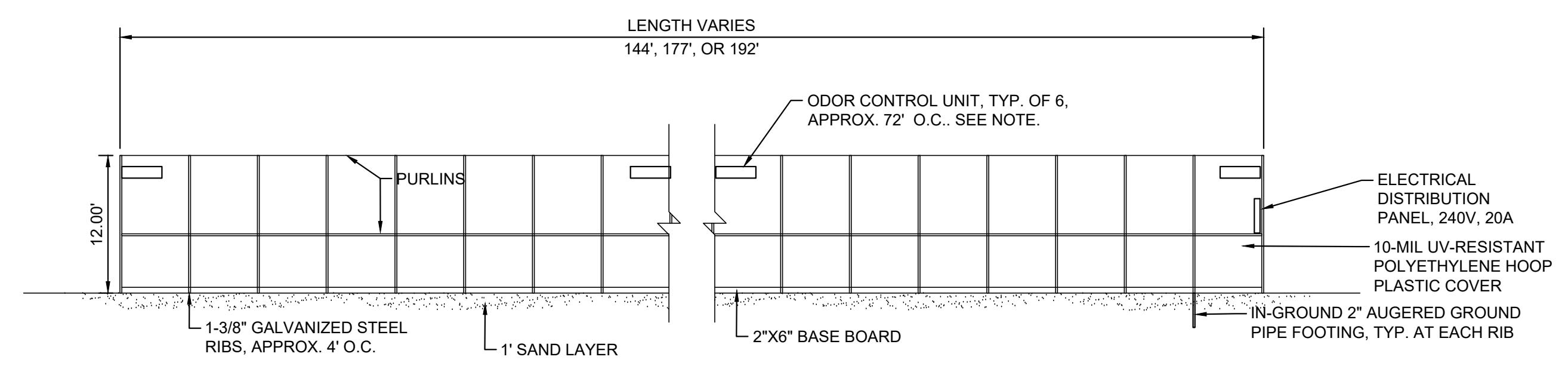

3 PROPOSED HOOP DETAIL - SECTION
Scale: NTS

- NOTE:
- HOOP HOUSE POLYETHYLENE PLASTIC FILM SHALL BE 6" ABOVE GRADE.
 - ODOR CONTROL SHALL BE PROVIDED THROUGH CARBON BASED AIR FILTERS. HOOP HOUSE AIR VOLUME RANGES FROM 37,200 TO 49,500 CF. ODOR FLOW CONTROL UNITS SHALL BE SIZED TO TREAT A TOTAL OF 3 AIR VOLUMES PER HOUR.

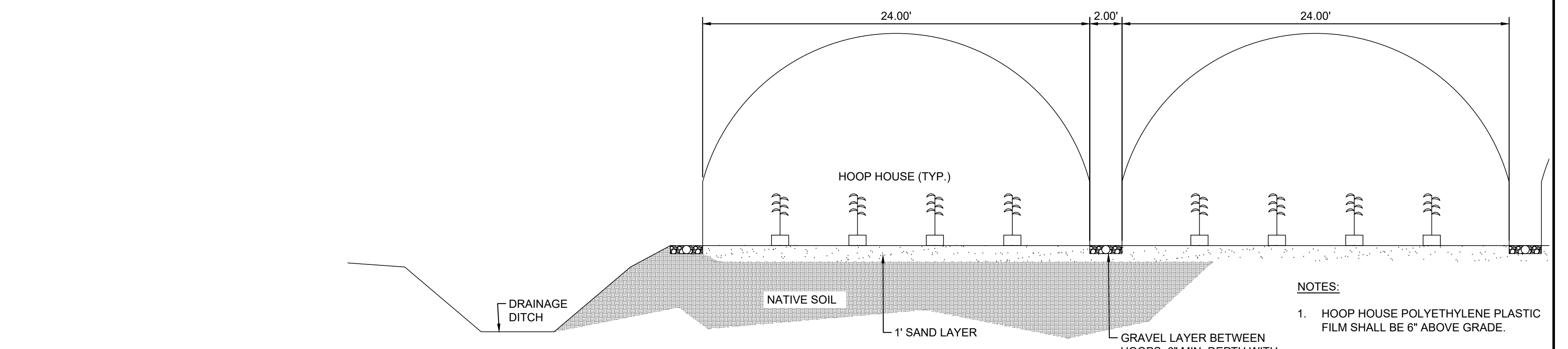

A HOOP ELEVATION
Scale: 1:5

- NOTES:
- HOOP HOUSE POLYETHYLENE PLASTIC FILM SHALL BE 6" ABOVE GRADE.
 - DRIP IRRIGATION RUNS THROUGH THE CENTER OF ROW CROPS.

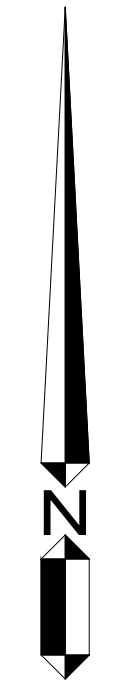
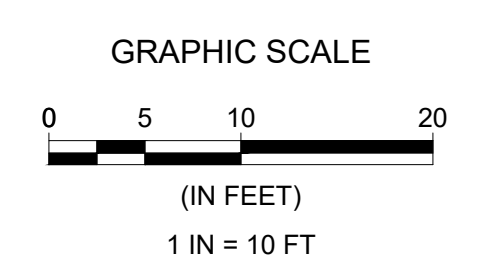

ARCATA LAND COMPANY, LLC
3318 FOSTER AVENUE, ARCATA, CA
DETAILS - HOOP HOUSES
SHEET C4.0



Fertilizer Loading and Mixing Standard Operating Procedure

Title: Fertilizer Loading and Mixing SOP

Doc. No.: SOP-OPR-006

Rev. : A

Area: Arcata Land Company

Date: March 14, 2020

Doc. Owner: Tim Crockenberg

1.0 PURPOSE

- 1.1 To make the right fertilizer recipe to be delivered in the irrigation system to the crop in the greenhouse according to plant nutrient demand.

2.0 SCOPE

- 2.1 This procedure must be observed by any Team Member performing the mixing of the fertilizers formulas. Only authorized Team Members can follow the steps described in this procedure.
- 2.2 If you have any doubt about your responsibilities please check and confirm with your Manager before proceeding.

3.0 REFERENCES

- 3.1 Fertilizers Safety Data Sheets (SDS)
 - 3.1.1 Check the ALC fertilizers SDS binder
- 3.2 Preparation of fertilizer solutions: Physical and chemical considerations. Haifa Group table (Can be seen in the attachments in this procedure)

4.0 DEFINITIONS

- 4.1 **SDS (formerly known as MSDS: Material Safety Data Sheet):** Safety Data Sheet: Document that contains the information on potential health effects of exposure to chemicals or other potentially dangerous substances and on safe working procedures when handling chemical products.
- 4.2 **pH:** is a measure of hydrogen ion concentration; a measure of the acidity or alkalinity of a solution. Aqueous solutions at 25°C with a **pH** less than seven are acidic, while those with a **pH** greater than seven are basic or alkaline.
- 4.3 **EC (Electrical conductivity):** When an electrical current passes through a wire, what moves and carries the current are the ELECTRONS. But in solutions, the current is carried by IONS: positively charged CATIONS [+] such as H⁺, Na⁺, Mg⁺, etc. and negative ANIONS [-] such as OH⁻, Cl⁻, Acetate⁻, etc. The conductivity of a solution depends on the concentration of ALL the ions present, the greater their concentrations, the greater the conductivity, These ions all have the electrical unit charges shown by their symbols, but they move at different velocities through the solution, so they contribute differently to the conductivity. The conductivity is the sum of the contribution of ALL the ions present in the solution

- 4.4 **Dry matter:** Is what remains after all of the water is evaporated out of a feed: grain and fresh or dried forages.
- 4.5 **Fertilizer:** Is a material of natural or synthetic origin that is applied to the soil or the plants to supply one or more nutrients essential for the growth of the plants. Fertilizers are commonly used for growing all crops, with application rates depending on the soil fertility and according to the particular crop. The nutrients required for healthy plant life are classified according to the elements. Plants are made up of four main elements: Hydrogen, Oxygen, Carbon, and Nitrogen.
- 4.5.1 **Macronutrients elements:** The macro-nutrients are consumed in larger quantities and are present in plant tissue in quantities from 0.15% to 6.0% on a dry matter (DM).

Chemical element	Name	Application
N	Nitrogen	Leaf growth
P	Phosphorus	Develop of roots, flowers, seeds, fruits
K	Potassium	Strong stem growth, movement of water in plants, promotion of flowering and fruiting
Mg	Magnesium	Has an important role in photosynthesis because it forms the central atom of chlorophyll. Without sufficient amounts of magnesium, plants begin to degrade the chlorophyll in the old leaves. Chlorophyll is the pigment that gives plants their green color and carries out the process of photosynthesis.
Ca	Calcium	Calcium in plants increases the nutrient uptake, build strong cell walls for sturdier plants, and increase vitality. A Calcium deficiency will cause severe plant stress, visual symptoms include: necrosis at the tips and margins of young leaves; bulb and fruit abnormalities; deformation of leaves; highly branched, short, brown root systems; severe, stunted growth; and general chlorosis.
S	Sulfur	In plants, sulfur is essential for nitrogen-fixing nodules on legumes and necessary in the formation of chlorophyll. Plants use sulfur in the processes of producing proteins, amino acids, enzymes and vitamins. Sulfur also helps the plants resistance to disease, aids in growth, and in seed formation.

- 4.5.2 **Micronutrients:** Are consumed in smaller quantities and are present in plant tissue on the order of parts-per-million (ppm), ranging from 0.15 to 400 ppm DM (Dry matter), or less than 0.04% DM. These elements are often present at the active sites of enzymes that carry out the plant's metabolism. Micro elements- Fe, B, Cu, Mo, M, can be find individual or in all al combination like Micronutrients chelate.

Chemical element	Name	Application
Fe	Iron	First of all, iron is involved when a plant produces chlorophyll, which gives the plant oxygen as well as its healthy green color. This is why plants with an iron deficiency, or chlorosis, show a sickly yellow color to their leaves. Iron is also necessary for some enzyme functions in many plants.
B	Boron	Function: Boron is used with calcium in cell wall synthesis and is essential for cell division (creating new plant cells). Boron requirements are much higher for reproductive growth so it helps with pollination, and fruit and seed development
Cu	Copper	Copper activates some enzymes in plants which are involved in lignin synthesis and It is also required in the process of photosynthesis, is essential in plant respiration and assists in plant metabolism of carbohydrates and proteins.
Mo	Molybdenum	Involved in the nitrogen metabolism, essential in nitrogen fixation by legumes.
Mn	Manganese	Is used in plants as a major contributor to various biological systems including photosynthesis, respiration, and nitrogen assimilation.

5.0 SAFETY RECOMMENDATIONS (PERSONAL PROTECTION EQUIPMENT)

- 5.1 It is mandatory to read and understand the SDS of the fertilizer materials used in the preparation solution process and the hazard situation to which can be exposed before using these
- 5.2 It is mandatory the use of the Personal Protection Equipment all the time when manipulate these materials.
- 5.3 For fertilizers preparation, the following PPE is required:

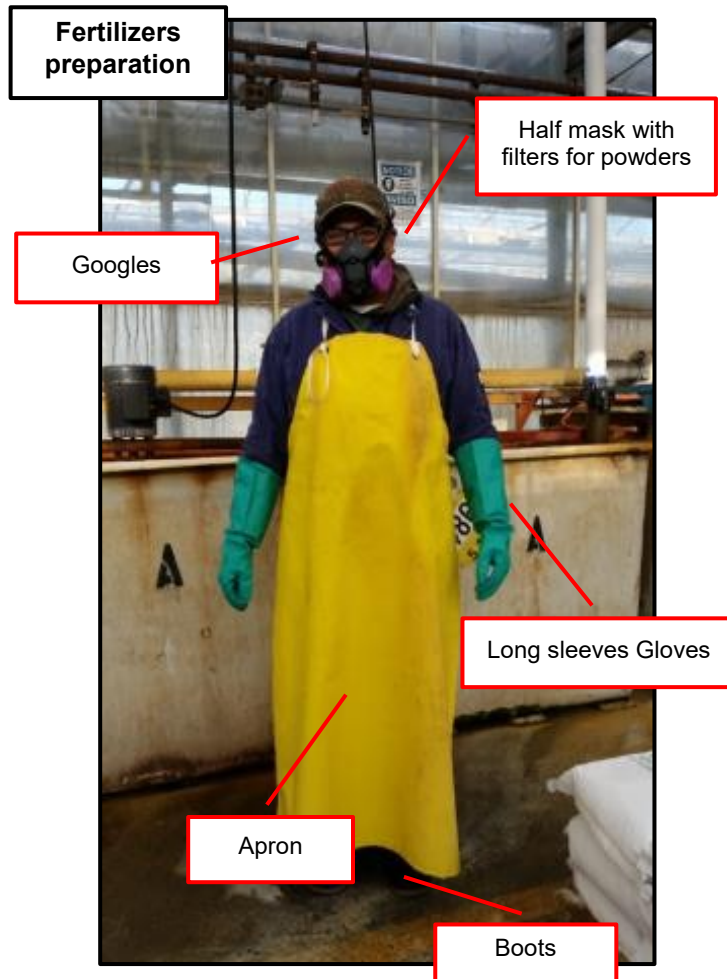

5.4 For Acids preparation, the following personal protection equipment is required:

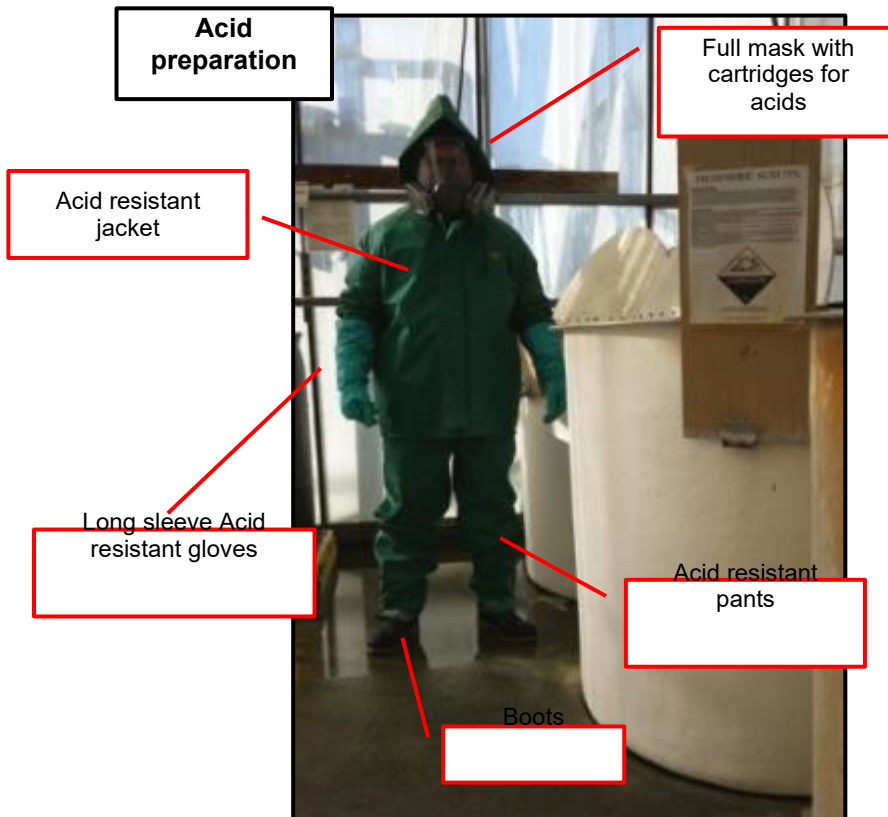

- 5.5 Always keep your area clean and organize
- 5.6 Each chemical or fertilizer must be well identified and stored in a dry and safe place under a safety lock.
- 5.7 It is mandatory to have an “**Eye wash station**”, a “**First aid kit**” and an “**Emergency spill kit**” in the fertilizers mixing area.
- 5.8 The person in charge should have all knowledge to provide first Aid in case of accident. That means this person should be certified.

6.0 PROCEDURE

FERTILIZERS STORAGE

- 6.1 All fertilizers should be stored in an locked area with access only to authorized Team members



- 6.2 Warning/Danger signs should be posted to identify the storage room
- 6.3 All stored fertilizers containers must be identified, properly labeled and properly closed to prevent any spill or scatter.
- 6.4 The storage area should have a list off all the stored fertilizers and a binder with all the SDS.

FERTILIZERS MIXING

- 6.5 Remember to wear your PPE (Personal Protection Equipment) before handling the fertilizers
- 6.6 The fertilizer formula is prepared in 2 different tanks labeled as “**A**” & “**B**” and the “**Acid**” formula to adjust the PH of the fertilizers mix is prepared on a third tank, labeled as “**C**”.
- 6.7 Mixing different fertilizers can sometimes result in the formation of precipitates, to avoid this, fertilizers are mix in two separated tanks:
 - Tank A – Combination of micronutrients: Calcium, Nitrates, Potassium, Iron, Sulfur, Boron, Manganese, Cooper, Molybdenum, MPH, NH₄NO₃, Fe, MgNO₃
 - Tank B - CaNO₃, KNO₃, Macro elements
- 6.8 To proceed with the preparation of the fertilizer, first turn all the irrigation pumps OFF.

6.9 Open the pumps switches box and move all pump switches to the OFF position.

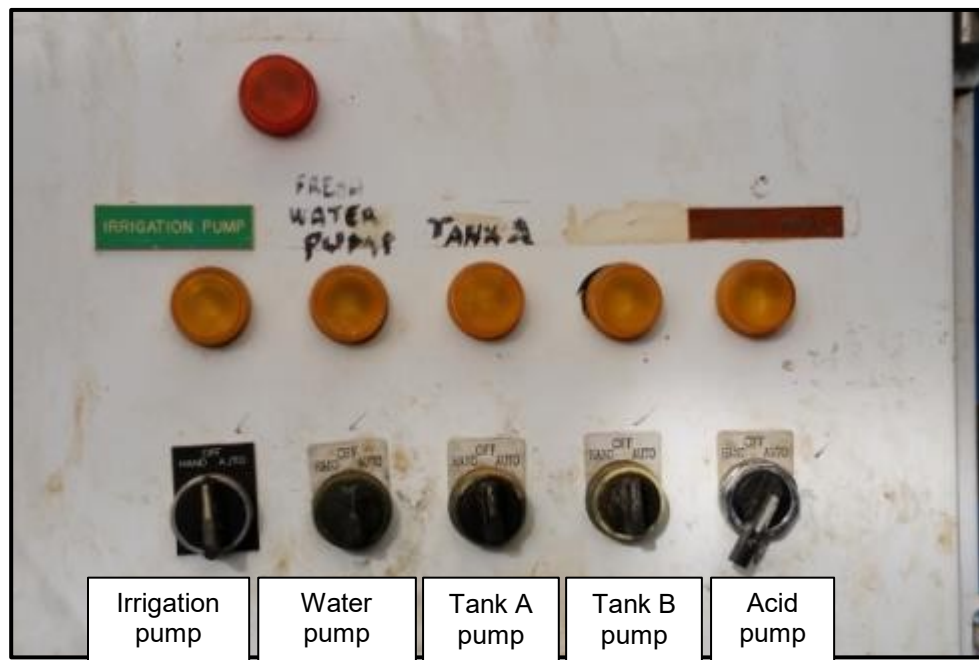

TANK "A" MIX PREPARATION

6.10 Every "Tank A" has a capacity of 200 gals, 4 "Tanks A" are available, the same described formula needs to be prepared on each tank.



- 6.11 Inspect and determine if the tank has a volume below 25% of its capacity, if this case, proceed and fill the tanks with dull water all the way to approximately half the tank.



- 6.12 Slowly add to each Tank A the following fertilizers:
- 6.12.1 300 lbs. Calcinit (6 bags)
 - 6.12.2 150 lbs. Ultrasol K Plus (3 bags)
 - 6.12.3 16 oz. Brandt Sequestar 13.2% Fe (Use a 16 oz. measuring cup)
 - 6.12.4 8 oz. STEM (Soluble Trace Element Mix, half of the 16 oz. measuring cup)

16 oz. measuring cup





- 6.13 When adding the fertilizers, the mixers should be in operation to homogenize the formula.
- 6.14 It is a good practice to leave in front of the tanks the empty bags of the fertilizers that has been added, to keep a good track of the quantities added to every tank.
- 6.15 Once added all the ingredients, fill the tank with water opening the water valve



- 6.16 Close the valve and proceed, the tank A preparation has been concluded.

TANK "B" MIX PREPARATION

- 6.17 Tank B has a capacity of 400 gals, inspect and determine if the tank has a volume below 25% of its capacity, if this case, proceed and fill the tank with dull water to approximately half the tank.
- 6.18 Open the water valve and fill only half of the tank.



6.19 Close the valve and with the mixer in operation proceed to slowly add the following ingredients to the tank.

6.19.1 400 lbs. Power Mag 10 (8 bags)

6.19.2 300 lbs. Monopotassium Phosphate (6 bags)



6.20 When finish adding all elements to the formulation, complete the tank with water, the tank should be full.



6.21 The tank B preparation has been concluded.

ACID PREPARATION

- 6.22 The pH adjustor usually it is an ACID like, Nitric, Phosphoric or Citric .This element it is really important in fertilizer process helping some elements to be easy uptake by the plants and to prevent diseases infection.
- 6.23 The use of full body protection it is required for the acid preparation, extra precautions are required during this process.
- 6.24 Fill approximately $\frac{3}{4}$ of the acid tank with water.



Approx. $\frac{3}{4}$
water level

- 6.25 Close the water valve.
- 6.26 **Never add water to the acid, this causes an exothermic reaction releasing a lot of heat, the solution may boil violently, splashing concentrated acid out of the container. On the other hand, adding acid to water, the solution that forms is very dilute and the small amount of heat released is not enough to vaporize.**
- 6.27 The phosphoric acid diluted to a concentration of 75% comes in UN drums (Certified drums to be used to transport chemicals).
- 6.28 A drum of Phosphoric acid is placed over a spill containment pallet to collect any possible spills.



- 6.29 The handling of the drums is made by using a manual drum lifter



- 6.30 After filling the acid tank up to $\frac{3}{4}$ of its capacity with water, proceed to add the phosphoric acid.
- 6.31 Always keep the mixer in operation during this process.

- 6.32 The phosphoric acid pump is remotely activated by a switch located below to the Personal Protection Equipment cabinet.



- 6.33 By not having anyone near to the acid tanks, push the acid pump switch to start pumping the phosphoric acid to the tanks "C".
- 6.34 Filling the tanks "C" with acid will take approximately 2 minutes plus 15 seconds. Due to the duration of the filling of the tanks, if available it is recommended to use a chronometer to keep track of the time.
- 6.35 Always keeps an eye of the filling of the tanks while pushing the acid pump switch.



6.36 Once tank is full, stop the pumping of acid.



6.37 When not in use, unplug the acid pump from the outlet, this to prevent anyone to turn the pump ON when not required.



6.38 The phosphoric acid preparation has been concluded

FILTER CLEANING

- 6.39 The delivering of the fertilizers mix formula is done by electrical pumps; these pumps have a metallic trap (filter) that collects any debris that may be mixed in the solution.
- 6.40 After performing the fertilizers mix preparation and before starting to deliver this to irrigation, it is necessary to perform the cleaning of the Tank A and Tank B filters.
- 6.41 Identify the location of the Tank A and Tank B filters



6.42 Close the valves coming into the pumps and remove the cover of the “Y” connector, pull the filter out.



6.43 Thoroughly clean the filter by using a plastic brush.



6.44 Once finished, return it back to the “Y” connector and tight the cap.

6.45 Don't forget to clean both filters “Tank A” and “Tank B”

6.46 Open the valves coming to the tanks

6.47 The Tank A and B filters cleaning has been concluded

LOG BOOK AND CLEANING OF THE AREA

- 6.48 After the preparation of the fertilizers it is mandatory to document the fertilizers quantities added in the Fertilizers log, this need to be signed by the Team Member that prepared the mix.



- 6.49 Return the pump switches back to their automatic position, close the control panel with the cover and lock it again.





- 6.50 Proceed to clean and remove all the empty fertilizers bags from the room and dispose these in the outside tote





6.51 Wash and sweep the floor, leave your area clean.



FERTILIZERS IRRIGATION

- 6.52 The fertilizers mix ingredients depend on factors like:
- 6.52.1 Kind of crop
 - 6.52.2 Developing stages
 - 6.52.3 Environment
 - 6.52.4 Finishing stages
 - 6.52.5 Quality and quantity of yield
 - 6.52.6 Harvesting date
 - 6.52.7 Laboratory result from the previses samples
 - 6.52.8 Elements balance according with lab results and crop performance
- 6.53 The irrigation of the fertilizers to the greenhouses is performed by an automatic system controlled by a computer program; the program set on the computer starts and stops the irrigation of the crops, adjusting the E.C. and pH to the required levels. The system used in ALC Arcata to control the irrigation of the greenhouses is the PRIVA.
- 6.54 The probe IS placed in to the mixed fertilizer flow that reads the E.C. and pH level from the fertilizer solution. This information is delivered to the computer program to automatic adjust these parameters in the solution according with setting goals.



- 6.55 After the EC and pH match the goal for the destination crop, this fertilizer it is ready to be applied.
- 6.56 Delivery pump-It is a pump with capacity to deliver mix fertilizer from the mixing tanks to the greenhouse keeping the pressure steady all the way.
- 6.57 Delivery irrigation lines - Represent the pipes network from the delivery pump to the crop. The dimension and structure of these pipes is calculated taking in consideration the pump capacity and the pressure required.
- 6.58 Pressure regulator: Keeps the pressure on the right level for uniformity fertilizer delivery to the crop

- 6.59 Irrigation sprinklers - It is according with kind of irrigating tip and the volume to be applied to the crop (Overhead, dripper, mist, etc.)



7.0 TRAINING

- 7.1 The training on this Standard Operation Procedure should be performed by the Grower or the Grower Assistant.
- 7.2 Any training should be documented and signed by the Trainer and the Team Member; records should be kept on file in the Human Resources department.
- 7.3 This procedure should be reviewed with the Team Members every time that there is a Revision change.

8.0 RECORD KEEPING

- 8.1 It is required to keep all fertilizers mix formulation and any laboratories analysis results on file.

9.0 ATTACHMENTS

- 9.1 Preparation of fertilizer solutions: Physical and Chemical considerations.

Preparation of fertilizer solutions: physical and chemical considerations

Water solubility of solid fertilizers at various temperatures

	Solubility in water (g/liter)		
	10°C	20°C	30°C
Urea	450	510	570
Ammonium nitrate	610	660	710
Haifa MAP™	290	370	460
Haifa MKP™	180	230	290
Multi-K™ (potassium nitrate)	210	310	450
Haifa SOP™	80	100	110
Haifa Cal™ (calcium nitrate)	950	1200	1500
Magnisal™ (magnesium nitrate)	2200	2400	2700
Magnesium sulfate	620	710	810

Note: most fertilizers absorb heat from the water upon dissolution, thus lowering the temperature of the solution in what is termed an endothermic reaction.

Tip for success: when preparing a fertilizer solution, first fill half of the tank with water, and then slowly add the dry fertilizer while constantly agitating the solution. Complete by filling water. This sequence enhances dissolution and prevents formation of lumps on the bottom of the tank.

Compatibility of fertilizers

Mixing two different fertilizers can sometimes result in formation of precipitates. Such cases indicate that these fertilizers are not compatible and special care must be taken to avoid mixing them in the same tank. The solutions should be prepared in two separate tanks referred as Two Tank system. Use the chart to determine whether fertilizers can be dissolved together in the same tank or should be separated.

	Urea	AN	AS	MAP	MKP	PN	PN+Mg	PN+P	SOP	CN	N+Mg	NPK+ME
Urea	✓	C	C	C	C	C	C	C	C	C	C	C
Ammonium nitrate (AN)	C	✓	C	C	C	C	C	C	C	C	C	C
Ammonium sulfate (AS)	C	C	✓	C	C	L	L	C	C	L	C	C
Haifa MAP™	C	C	C	✓	C	C	L	C	C	X	X	C
Haifa MKP™	C	C	C	C	✓	C	L	C	C	X	X	C
Multi-K™ (potassium nitrate - PN)	C	C	L	C	C	✓	C	C	C	C	C	C
Multi-K™ Mg (PN+Mg)	C	C	L	L	L	C	✓	X	C	X	C	C
Multi-npK™ (PN+P)	C	C	C	C	C	C	X	✓	C	X	X	C
Haifa SOP™	C	C	C	C	C	C	C	C	✓	X	C	C
Haifa Cal™ (calcium nitrate - CN)	C	C	L	X	X	C	X	X	X	✓	C	X
Magnisal™ (magnesium nitrate - N+Mg)	C	C	C	X	X	C	C	X	C	C	✓	C
Poly-Feed™ (NPK+ME)	C	C	C	C	C	C	C	C	C	X	C	✓

C - Compatible L - Limited compatibility X - Incompatible

The figure provide rules of thumb for preparing fertilizer solution in a Two Tank system

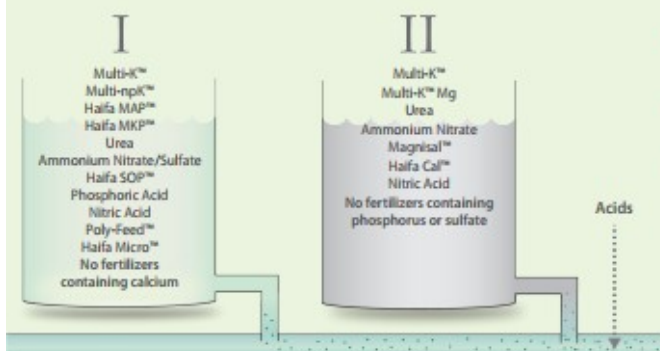

Tips for success:

- Fertilizers containing phosphate or sulfur should not be mixed with calcium fertilizers.
- Phosphoric or sulfuric acids should be added only to the non-calcium containing tank or they can be injected directly to the irrigation water.
- Nitric acid may be added to either tanks or injected directly to the irrigation water.
- To maintain the stability of the micronutrient chelates, the pH in the tank should be higher than 4.

10.0 APPROVEERS

POSITION	NAME	SIGNATURE/DATE
Arcata Farm Manager	Tim Crockenberg	
Safety Manager		
CIP Manager	Marisol Marquez	

11.0 CHANGE HISTORY LOG

Rev	Date	BRIEF DESCRIPTION OF CHANGE	REASON FOR CHANGE
A		Standard Operation Procedure Release	N/A

Injury and Illness Prevention Program

ARCATA LAND COMPANY

INJURY AND ILLNESS PREVENTION PROGRAM

Prepared By:



2130 Brundage Lane
Bakersfield, CA 93304-2702
(661) 377-8300

September, 2019

COMPañÍA	ASUNTO	MANUAL	MATERIA
Arcata Land Co.		IIPP	IIPP TABLE OF CONTENTS

IIPP TABLE OF CONTENTS	2
INJURY & ILLNESS PREVENTION	3
COMPANY POLICY STATEMENT	3
RESPONSIBILITIES	3
MANAGEMENT.....	3
EMPLOYEES	4
COMPLIANCE.....	4
COMMUNICATION.....	4
HAZARD ASSESSMENT	4
INCIDENT/ACCIDENT/NEAR MISS INVESTIGATION	11
HAZARD MITIGATION	14
TRAINING AND INSTRUCTION	14
RECORD-KEEPING	15
PROGRAM AUDIT AND SAFETY INSPECTIONS	16
VIOLENCE IN THE WORKPLACE	16
PERSONAL PROTECTIVE EQUIPMENT	16
CLOTHING.....	16
SIGNS	17
EMPLOYEE INFORMATION BOARD	17
AMERICANS WITH DISABILITIES ACT	17
SAFETY POLICY VIOLATIONS AND REINFORCEMENT.....	17
POLICY AGAINST HARASSMENT	19
WORKPLACE SAFETY PRINCIPLES	20
EMPLOYEE RECEIPT OF INJURY AND ILLNESS PREVENTION PROGRAM.....	21
NOTICE TO ALL EMPLOYEES: ACCESS TO SAFETY DATA SHEETS.....	21
IIPP APPROVAL.....	22
REVIEWED AND APPROVED:	22
SECTION 1	23
HAZARD COMMUNICATION PROGRAM	24
SECTION 2	26
HEAT ILLNESS PREVENTION	27
SECTION 3	35
LOCKOUT/BLOCKOUT/TAGOUT	36

COMPANY	ISSUED	MANUAL	SUBJECT
Arcata Land Co.		IIPP	INJURY & ILLNESS PREVENTION

Company Policy Statement

The Arcata Land Company believes strongly that all accidents are preventable, and nothing is more important to us than the safety and well-being of our employees. Arcata Land Company also commits to protect the environment to the best of our ability. Each of our employees is acquainted and trained in Injury & Illness Prevention, and are responsible for ensuring compliance with all local, state, and/or federal laws. Full documentation of our Environmental, Health, and Safety programs can be found at: 3318 Foster Ave, Arcata, CA 95521.

Responsibilities

The person who has the overall responsibility for the implementation and administration for Arcata Land Company Injury & Illness Prevention Plan is Tim Crockenberg.

Management

1. All managers and supervisors of Arcata Land Company are responsible for the overall implementation of the Injury & Illness Prevention Plan as it pertains to their jobsite. Each manager/supervisor for Arcata Land Company will maintain a copy of the Injury & Illness Prevention Plan for review by employee request.
2. Arcata Land Company managers/supervisors will encourage safe working habits among employees and will strictly enforce Company safety rules fairly and evenly.
3. The Sun Valley Group will provide training and Personal Protective Equipment as needed to ensure a safe and productive work environment. To this end, The Sun Valley Group has created Codes of Safe Practices to be followed by employees to assist them in safely conducting work.
4. Managers/supervisors will receive training and instruction to familiarize themselves with the safety and health hazards to which employees under their immediate direction and control may be exposed.
5. Managers/supervisors are responsible for investigating any reports of unsafe conditions brought to their attention by employees. Managers/supervisors will take corrective actions as needed, up to and including work stoppage.
6. Managers/Supervisors will work with The Sun Valley Group upper management to set and verify achievement of target goals for safety, loss prevention, and performance by:
 - a. Verifying employee participation through annual reviews of certifications, disciplinary notices, etc.
 - b. Ensuring compliance with The Sun Valley Group programs by employees and/or contractors.
 - c. Enforcing safety policies.
 - d. Investigating any incident or 'near miss' with the potential for injuries and/or damage.
 - e. Conducting periodic safety inspections.
 - f. Promptly correcting and/or reporting any unsafe condition.
 - g. Conducting regular safety meetings and providing documentation of employee participation.
 - h. Ensuring all employees have successfully passed required training sessions and are capable of working in a safe manner.
 - i. Ensuring all employees are familiar with specific jobsite hazards to which they might be exposed.
 - j. Stopping work/tasks at any jobsite under his/her control that is deemed to be unsafe.
 - k. Ensuring that emergency procedures will be invoked when appropriate.

- I. Take corrective actions in regard to employee behavior/negligence, up to and including written warnings and/or immediate termination.

Employees

1. The Sun Valley Group employees are fully trained are expected to assume personal responsibility for their ongoing safe behavior while at work.
2. In addition, The Sun Valley Group employees are responsible for:
 - a. Familiarizing themselves with all The Sun Valley Group safety programs.
 - b. Refraining from performing any function for which they have not been trained.
 - c. Making sure all work is performed safely.
 - d. Following established company practices and governmental regulations.
 - e. Safely using all tools as required.
 - f. Properly using Personal Protective Equipment as needed and/or required.
 - g. Immediately reporting any/all injuries, 'near misses', unsafe conditions, and/or defective equipment to their supervisor. The Sun Valley Group will not tolerate retaliation against any employee who reports an unsafe condition, negative behavior, and/or workplace hazard.
 - h. Assisting in incident investigations.

Compliance

The Sun Valley Group will ensure compliance through:

1. Providing our employees with all applicable safety training, including Hazard Communication, Injury & Illness Prevention, and task-specific training as needed.
2. Evaluating the performance of our employees in regard to safety on an annual basis.
3. Encouraging participation in safety programs through recognition.
4. Disciplining any employee who fails to adhere to our safety programs and procedures. Discipline can include:
 - a. Verbal Warning – Documented and placed in the employee's personnel file.
 - b. Written Warning – Documented and placed in the employee's personnel file.
 - c. Dismissal – Documented and placed in the employee's personnel file.

Communication

The Sun Valley Group understands the importance of communication, especially when it concerns safety. The Sun Valley Group will conduct periodic safety meetings to highlight safety and/or environmental issues and how to achieve resolution. Records of these meetings will be kept in the main office at 3160 Upper Bay Road, Arcata, CA 95521. Subject matter for these meetings may include:

1. Results of Program Audit & Safety inspections;
2. Reviews of any incidents and/or 'near misses' and offer solutions to mitigate similar situations;
3. Review potential hazards and their potential mitigation techniques;
4. Review employee-submitted safety suggestions;
5. Audit safety information/programs as needed;
6. Conduct safety training sessions at least once per month.

Hazard Assessment

The Sun Valley Group recognizes the need to identify and communicate workplace hazards to its employees. The Sun Valley Group will conduct periodic Program Audit & Safety inspections to locate and identify hazards. These inspections will be performed by either The Sun Valley Group supervisors or outside (3rd party) consultants. Whenever workplace/jobsite hazards are identified, the appropriate supervisor will be notified. These hazards will be removed or mitigated to provide our employees with a safe area in which to work.

Inspections will be performed as follows, utilizing a Job Hazard Analysis Form:

1. Job Locations – Quarterly;
2. Shops and Yards – Quarterly;
3. Equipment – Jobsite - Prior to use and/or Quarterly;
4. Equipment – Shop/Yard – Prior to use and/or Quarterly;
5. Overhead Cranes – Prior to use;
6. Vehicles – Basic items (windshield wipers, fluids, brakes, tires, etc.) – Prior to use;
7. Vehicles – Mechanical items (drive-train, etc.) – Prior to use;
8. Whenever new substances, processes, procedures, equipment, and/or hazards are introduced;
9. Following any accident, injury, or 'near miss';
10. As needed, determined by supervisors/managers.

HAZARD ASSESSMENT FORM

Name of person filling out this form: _____

Date: _____

Department: _____

Description of Condition, Job Title, etc.: _____

CHEMICAL HAZARDS

Are chemicals to be used? _____ Yes No NA Is there

a toxic hazard? _____ Yes No NA Is there a

volatility hazard? _____ Yes No NA Is there a

carcinogenic, mutagenic, or teratogenic hazard? _____ Yes No NA

Description of hazard(s): _____

Recommended mitigation: Administrative/Engineering controls/PPE: _____

ELECTRICAL HAZARDS

Is electrical equipment to be used? _____ Yes No NA

Does the voltage measure in excess of 1000V? _____ Yes No NA

Description of hazard(s): _____

Recommended mitigation: Administrative/Engineering controls/PPE: _____

EYE HAZARDS

Is there a possibility of chemical exposure? _____ Yes No NA Are

workers faced with extreme temperatures (hot or cold)? _____ Yes No NA Is there

dust/flying debris in the area? _____ Yes No NA Is there a

possibility of impact/collision? _____ Yes No NA Is there the

possibility of exposure to excessive light/radiation? _____ Yes No NA Is there a possibility

of chemical splash? _____ Yes No NA

Description of hazard(s): _____

Recommended mitigation: Administrative/Engineering controls/PPE: _____

HEAD HAZARDS

Is there a possibility of impact/collision? _____ Yes No NA Is there a possibility of electrical shock? _____ Yes No NA Are workers faced with extreme temperatures? _____ Yes No NA Is there a possibility of chemical splash? _____ Yes No NA

Description of hazard(s): _____

Recommended mitigation: Administrative/Engineering controls/PPE: _____

FOOT HAZARDS

Is there a possibility of chemical exposure? _____ Yes No NA Are workers faced with extreme temperatures (hot or cold)? _____ Yes No NA Is there a possibility of impact/collision? _____ Yes No NA Is there a chance for slips, trips, or falls? _____ Yes No NA Is there a possibility for punctures from below? _____ Yes No NA Are surfaces wet, slippery, icy, or otherwise treacherous? _____ Yes No NA Is an explosive/flammable atmosphere present? _____ Yes No NA Is electrical shock a possibility? _____ Yes No NA Is there a possibility of chemical splash? _____ Yes No NA

Description of hazard(s): _____

Recommended mitigation: Administrative/Engineering controls/PPE: _____

HAND HAZARDS

Is there a risk of chemical exposure? _____ Yes No NA Are workers exposed to extreme temperatures? _____ Yes No NA Is there a possibility for cuts/abrasions? _____ Yes No NA Is there a chance for a puncture? _____ Yes No NA Is electric shock a possibility? _____ Yes No NA Are bloodborne pathogens present in the area? _____ Yes No NA Is there a possibility of chemical splash? _____ Yes No NA Are there any pinch-points? _____ Yes No NA

Description of hazard(s): _____

Recommended mitigation: Administrative/Engineering controls/PPE: _____

BODY/TORSO HAZARDS

Will the employee be required to work at heights over 6-feet? _____ Yes No NA Are conditions present that could physically crush an employee? _____ Yes No NA Are workers exposed to extreme temperatures? _____ Yes No NA Is there a possibility of being exposed to radiation? _____ Yes No NA Is there a possibility of chemical exposure? _____ Yes No NA Is there a possibility of electric shock? _____ Yes No NA Is there a possibility of impact? Yes No NA Is there a possibility of abrasion? _____ Yes No NA Is there a possibility of chemical splash? _____ Yes No NA

Description of hazard(s): _____

Recommended mitigation: Administrative/Engineering controls/PPE: _____

NOISE HAZARDS

Is the area subject to noisy conditions? _____ Yes No NA

Description of hazard(s): _____

Recommended mitigation: Administrative/Engineering controls/PPE: _____

RESPIRATORY HAZARDS

Is there a possibility for chemical exposure? _____ Yes No NA Is there a possibility for particulate exposure? _____ Yes No NA Is the area a Confined Space? _____ Yes No NA Is there a possibility to exposure to fumes, dusts, vapors, or mists? _____ Yes No NA

Description of hazard(s): _____

Recommended mitigation: Administrative/Engineering controls/PPE: _____

SPECIAL PROVISIONS

Are any special time constraints associated with this task/condition? _____ Yes No NA

If so, describe: _____

Are any special Monitoring (personal or area) issues presented by this task/condition?

_____ Yes No NA

If so, describe: _____

Are there any special Waste Disposal issues presented by this task/condition?

_____ Yes No NA

If so, describe: _____

Are there any special First Aid considerations presented by this task/condition?

_____ Yes No NA

If so, describe: _____

Are there any special Training issues presented by this task/condition?

_____ Yes No NA

If so, describe: _____

Does this task/condition any special Emergency procedures? _____ Yes No NA

Description of hazard(s): _____

Recommended mitigation: Administrative/Engineering controls/PPE: _____

COMMENTS _____

HAZARD ACKNOWLEDGEMENT FORM

I have been apprised of the potential hazards associated with tasks/assignments located at:

I agree to heed all warnings and abide by The Sun Valley Group safety procedures while working at this site.

(name)

(signature)

(date)

Incident/Accident/Near Miss Investigation

Any/all incidents that result in an accident, injury, or 'near miss' will be reported promptly to the Competent Supervisor. The purpose is to ensure that incidents are investigated to determine the root cause(s) to prevent re-occurrence, not to assign blame.

Any incident resulting in an injury will initiate The Sun Valley Group emergency procedures as outlined in the The Sun Valley Group Emergency Action Plan. The first priority is to assure the injured worker receives competent and timely First Aid and/or medical attention. (Note: All injuries must be noted on the OSHA 300-Log.) Basic Emergency Response procedures are as follows:

Assistance will be given to the injured employee by those qualified to perform First Aid/CPR.

If needed, 9-1-1 will be called, or the injured worker will be transported to a qualified medical facility. If 9-1-1 is called, one employee will be designated to go out to the nearest street/intersection to guide emergency responders to the injured party.

All incidents, accidents, and/or 'near misses' will be promptly investigated by a team comprised of managers, supervisors, onsite employees, and/or 3rd party outside consultants competent in incident investigation. The following guidelines should be utilized:

1. Visit the scene as soon as possible following any incident, accident, or 'near miss'. Take pictures, sketch diagrams, take measurements, etc. wherever applicable. Document these proceedings.
2. Interview the injured worker (if possible) and witnesses, documenting these interviews. Ask them what they heard, saw, and even smelled. Whenever possible, have the witness write out and sign their statement. Interview witnesses apart from each other whenever possible.
3. Look for any potential factor that may have played a part in the incident. Document all findings.
4. Collect any physical evidence which may prove useful (defective parts, broken tools, etc.). Do not allow unauthorized persons to handle collected evidence. Make evidence available to legal counsel, insurance carriers, etc.
5. Determine the root cause(s) using an Accident Investigation Form. Make sure to include statements as to how to prevent future re-occurrences.
6. Take (and document) appropriate corrective actions.

ACCIDENT/NEAR MISS FORM

Report Date: _____

Report Prepared By: _____

Company Information:

The Sun Valley Group

3160 Upper Bay Road, Arcata, CA 95521

Employee Information:

Employee(s) involved

Name: _____

Sex: _____

SS #: _____

Job Description: _____

Wage: _____

Accident Information:

Was an accident report made? _____

Accident report reviewed? _____

Where did the accident occur? _____

Date and time of accident: _____

What was being done when the accident occurred? _____

How did the accident occur (describe the events fully)? _____

Was employee injured? What object or substance injured the employee? _____

Injury description: _____

Physician Name and address: _____

Hospital name (if hospitalized): _____

How long was the employee away from work? _____

Review and Recommendations _____

Hazard Mitigation

Access to any area where hazards/potential hazards are known to exist will be limited to those employees who have the proper training/certification to enter such areas. These hazardous areas may include (but are not limited to): confined spaces, elevated work surfaces, the immediate vicinity of chemical releases, or the immediate area of other undefined hazards.

During Emergency Response operations, only those employees with appropriate training and/or experience shall be allowed access to hazardous areas. In the event such a hazardous area exists, entry may only be made if all of the following conditions are met:

1. Approval is obtained from the appropriate supervisor/manager.
2. All hazards have been identified and mitigated through elimination of the hazard or the appropriate Personal Protective Equipment. This is best done by holding a quick meeting of concerned parties prior to anyone accessing the hazardous area.
3. The employee making access has been properly trained and is knowledgeable in the task they are to perform.
4. All required permits (and/or other documentation) have been granted.

Hazards presented by unsafe conditions, practices, or procedures shall be corrected when observed or discovered. In the event several hazards are present, they shall be evaluated and corrected based on the severity they present. Hazard correction will occur whenever a new hazard is discovered or introduced to the workplace.

In the event a hazard cannot be removed or immediately corrected, it is the duty of the jobsite supervisor/manager to stop all work at the site and remove all employees from the vicinity of the hazard. Call 9-1-1 if needed. (If 9-1-1 is called, the supervisor/manager will designate an individual to go to the nearest street or intersection to guide emergency responders to the scene of the incident.) It is the duty of the jobsite supervisor/manager to document the hazard and response actions taken.

Training and Instruction

Training and instruction will be provided to all new employees. Employees will be made aware of all potential hazards (including health, safety, and/or environmental hazards) and how to maintain a safe and productive working environment. Each The Sun Valley Group employee will be given job/task-specific training prior to being allowed to work, as well as overall training on our Injury & Illness Prevention Plan. Training will also be given whenever there is a change in job responsibilities, and/or whenever new substances, processes, procedures or equipment are discovered or introduced. Re-training may also be required in some cases following an accident, injury, or 'near miss' or whenever the employer is made aware of a new or previously unrecognized hazard. Supervisors will receive training and instruction to familiarize themselves with the safety and health hazards to which employees under their immediate direction and control may be exposed. Additionally, The Sun Valley Group will provide 'tail gate' safety meetings at least once every thirty working days.

Training may include (but is not limited to):

- The Sun Valley Group's Injury & Illness Prevention Plan
- The Sun Valley Group's Emergency Action Plan
- The Sun Valley Group's Fire Prevention Plan
- The Sun Valley Group's Codes of Safe Practices
- Hazard Communication
- Equipment-Specific Safety
- Fall Protection
- Elevated Platforms (including scissor-lifts, manlifts, etc.)
- Forklift Safety
- Lock-Out, Block-Out, Tag-Out Procedures
- Confined Space (entry and/or awareness)
- Hand & Power Tool Safety
- Machine Guarding

- Crane Safety
- Rigging Safety
- Defensive Driving
- Heat/Cold Stress (There is more information on this topic in the The Sun Valley Group Emergency Action Plan, including a map indicating shaded locations, emergency communication procedures, and First Aid.

In the event a task requires additional training, employees assigned to complete those tasks will be given function-specific training.

Record-Keeping

Records pertaining to The Sun Valley Group's safety programs are housed in the main office at 3160 Upper Bay Road, Arcata, CA 95521. These records may include:

- The Sun Valley Group's Injury & Illness Prevention Plan
- The Sun Valley Group's Emergency Action Plan
- The Sun Valley Group's Fire Prevention Plan
- The Sun Valley Group's Codes of Safe Practices
- Jobsite inspection forms
- Hazard Assessment inspections
- Unsafe work conditions and mitigation techniques utilized
- Employee training records

Individual employee training records will be maintained via roll sheet and/or individual records, housed in The Sun Valley Group's main office, located at 3160 Upper Bay Road, Arcata, CA 95521

Among the records to be kept are:

1. Program Audit & Safety Inspection reports
2. Actions taken to correct jobsite hazards
3. Employee training
4. Awards and disciplinary items
5. Incident investigation reports

The Sun Valley Group shall keep records of fatalities, injuries, and illnesses and must record each fatality, injury and illness that:

- Is worked related; and
- Is a new case; and
- Meets one or more of the general recording criteria.

Each recordable injury or illness must be entered on an OSHA 300 Log and 301 Incident Report, within seven (7) calendar days of receiving information that a recordable injury or illness has occurred.

A company executive must certify that he or she has examined the OSHA 300 Log and when found to be correct will sign the OSHA 300A Summary.

A copy of the annual summary must be posted in the establishment in a conspicuous place or placed where notices to employees are customarily posted. The posted annual summary is not altered, defaced or covered by other material.

The annual summary will be posted no later than February 1st of the year following the year covered by the records and the posting kept in place through April 30th.

The OSHA 300 Log, the privacy case list (if one exists), the annual summary, and the OSHA 301 Incident Report forms must be retained for five (5) years following the end of the calendar year that these records cover.

Program Audit and Safety Inspections

A program audit and safety inspection shall be conducted a minimum of once each quarter. Tim Crockenberg will work with safety consultants in problem solving.

Documentation of findings and corrections will be kept in a Safety File at 3160 Upper Bay Road, Arcata, CA 95521.

Additional program audit and safety inspections may be made by outside independent consultants if management deems necessary.

Program Audit and Safety Inspections will be made whenever new substances, processes, procedures, or equipment is introduced.

Violence in the Workplace

- Personnel must respect each other to avoid conflict.
- Any conflict between two or more parties causing discomfort must be reported to management.
- Any misconduct between employees of different or the same gender, possibly causing a violent reaction, must be avoided.
- Avoid walking through dark hallways.
- Be prepared and cautious in case you might be attacked.
- Be prepared to defend yourself if you are a high-risk victim.
- Make sure the work premises are well-lit and the parking structure is close to the work premises and also well-lit.

Personal Protective Equipment

Specific items of personal protective equipment and apparel may be required while on the job. In other instances, the work activity, local environment or unit policy will dictate the need for additional items of personal protective equipment. Protective equipment shall be inspected prior to use by the user, properly maintained and inspected additionally as required.

Protective equipment may include, but is not limited to, the following:

Head Protection

Hearing Protection

Foot Protection

Respiratory Protective Equipment

Face and Eye Protection

Protective Clothing

Hand Protection

Refer to the applicable Codes of Safe Practices regarding the specific personal protective equipment required for any given task, work area or circumstance.

Clothing

- Each employee shall wear clothing appropriate to the work to be performed.
- Contaminated clothing shall be changed as soon as possible.
- Loose or frayed clothing will not be worn at any time around any type of equipment.

- Sleeveless shirts, tank tops and shorts are not permitted unless approved by your supervisor.
- Full-length pants and shirts are mandatory in equipment areas.
- Neckties, neck chains, loose jewelry and rings shall be removed when working around moving/rotating machinery.
- Personal protective equipment and clothing must be maintained in sanitary condition and be ready for use at all times.
- Interchanging personal protective clothing or equipment between employees is strictly prohibited unless it has been properly cleaned.

Signs

The Sun Valley Group personnel shall be informed of the need to be especially conscientious and carefully observe all posted signs and warnings.

Never enter an area posted with signs using the words:

- Danger
- Stop
- Do not enter
- Pesticide
- Chemicals in use
- Keep out

Employee Information Board

An employee information board will be set up in a conspicuous area where all required California and Federal notices will be posted, such as the Worker's Compensation Notice, Discrimination in Employment signs, Pay Day Notice, Emergency Phone Numbers, etc.

Americans with Disabilities Act

1. The Americans with Disabilities Act prohibits employers from discriminating against qualified individuals with disabilities in job application procedures, hiring, firing, advancement, compensation, job training and other terms, conditions and privileges of employment.
2. Employers must not discriminate against individuals with disabilities who are qualified for a job, with or without reasonable accommodation.
3. The Sun Valley Group must reasonably accommodate the disabilities of qualified employees, unless an undue hardship would result. Reasonable accommodation may include: making existing facilities used by employees readily accessible to and usable by persons with disabilities; job restructuring; modifying work schedules; reassignment to a vacant position; acquiring or modifying equipment or devices; adjusting or modifying examinations, training materials or policies; and providing qualified readers or interpreters.
4. The Sun Valley Group employees will not ask job applicants about the existence, nature or severity of a disability. A job offer may be conditioned on the results of a medical examination or inquiry, but only if the examination or inquiry is required for all employees entering the job.
5. Tests for illegal drugs are not subject to the American with Disabilities Act's restrictions on medical examinations.

Safety Policy Violations and Reinforcement

General safety rules and specific safe and healthy work practices must be understood and followed by all employees. To ensure employee compliance, The Sun Valley Group will provide positive reinforcement (safety activities, management involvement, incentive programs, training, etc.) and corrections of unsafe performance (disciplinary action).

When needed, discipline will not focus only upon punishment. Instead, it will be used as a means of turning negative actions into positive responses, of helping to solve employee problems and helping employees learn to take responsibility for their own actions. To be effective, it will:

1. Establish and communicate job performance expectations.
2. Respond to safety violations quickly and fairly.
3. Discipline/reward consistently.
4. Counsel and motivate to promote positive work performance.

When the above positive reinforcement fails to ensure employee compliance, the following disciplinary action will take place (Labor Code 6401.7);

First Safety Violation: Oral warning given one (1) time for failure to follow proper safety procedures - documentation to file.

Second Safety Violation: Written warning - documentation to file.

Third Safety Violation: Suspension for three (3) days without pay - documentation to file.

Fourth Safety Violation: Written termination notice - documentation to file.

Blatant disregard for company safety policy resulting in an injury can be cause for immediate dismissal.

In the event an employee is terminated, he/she must receive his paycheck at that time.

Policy Against Harassment

The Sun Valley Group is committed to providing a workplace free of unlawful harassment as well as harassment based on sex or such factors as race, color, gender (including gender identity and gender expression), religion (including religious dress and grooming practices), national origin (including discrimination on the basis of possessing a driver's license to a person who cannot otherwise prove the he/she is legally present in the United States), ancestry, age, medical condition, genetic information, marital status, registered domestic partner status, physical or mental disability, sexual orientation, military or veteran status, or any other basis protected by federal, state or local law, ordinance or regulations. It also includes a perception that anyone who has any of those characteristics, or is associated with a person who has or is perceived as having any of those characteristics. The Sun Valley Group strongly disapproves of and will not tolerate the harassment of employees by managers, supervisors or co-workers. The Sun Valley Group will also work to protect employees from harassment by non-employees in the workplace.

Harassment includes verbal, physical and visual conduct that creates an intimidating, offensive or hostile working environment or that interferes with work performance. Some examples include racial slurs, ethnic jokes, posting of offensive statements, posters or cartoons or other similar conduct. Unwelcome sexual advances, requests for sexual favors and other verbal or physical conduct of a sexual nature constitute sexual harassment when (1) submission to conduct is made either explicitly or implicitly a term or condition of an individual's employment; (2) submission to or rejection of such conduct of an individual is used as the basis for employment decisions affecting such individual; or (3) such conduct has the purpose or effect of unreasonably interfering with an individual's work performance or creating an intimidating, hostile or offensive working environment.

Company policy also prohibits abusive conduct harassment. Abusive conduct is defined as conduct in the workplace, with malice, that a reasonable person would find hostile, offensive, and unrelated to the Company's legitimate interest. Such conduct includes repeated infliction of verbal abuse, the use of derogatory remarks, insults, and epithets, verbal or physical conduct that a reasonable person would find threatening, intimidating, or humiliating, or the gratuitous, sabotage or undermining of a person's work performance.

Any incident of harassment including work-related harassment by any company personnel or any other person should be reported promptly to the employee's supervisor or manager (or to any other member of management), who is responsible for investigating the matter. Managers who receive complaints or who observe harassing conduct should inform the proper persons immediately. The Sun Valley Group emphasizes that an employee is not required to complain to his / her supervisor if that supervisor is the individual who is harassing the employee.

Every complaint of harassment that is reported to company management will be investigated thoroughly, promptly and in a confidential manner. In addition The Sun Valley Group will not tolerate retaliation against any employee for making a complaint to his/her supervisor or to any other manager.

If harassment is established, The Sun Valley Group will discipline the offender. Disciplinary action for violation of this policy can range from verbal or written warnings up to and including immediate termination, depending upon the circumstances (With regard to acts of harassment by customers or vendors, corrective action will be taken after consultation with the appropriate management personnel).

Workplace Safety Principles

1. All work can be done safely.
2. Most accidents and injuries can be prevented.
3. The workplace shall be free from unreasonable risk.
4. Each worker must understand his task and how to accomplish it safely.
5. No business objective is more important than the safety of people.
6. Unsafe acts in the performance of your work are neither expected nor condoned.
7. Each person has the responsibility for his own safety as well as for the safety of his associates.

The Sun Valley Group will maintain an effective Injury and Illness Prevention Program. The program will include as a minimum:

1. Commitment to safety by management through engineering controls, administration controls and personal protective equipment;
2. Safety training;
3. Safety monitoring;
4. Regularly scheduled safety meetings;
5. Compliance with all applicable Governmental rules and regulations;
6. Quarterly program audit and safety inspections.

EMPLOYEE RECEIPT OF INJURY AND ILLNESS PREVENTION PROGRAM

I have reviewed the Injury and Illness Prevention Program from The Sun Valley Group and acknowledge that I have read this program, or it has been read to me, and that I am familiar with its contents and will abide by its guidelines.

Name:	
Date:	
Signature:	

NOTICE TO ALL EMPLOYEES: Access to Safety Data Sheets BY CAL/OSHA REGULATION - GENERAL INDUSTRY SAFETY ORDER 5194 - YOU, YOUR PHYSICIAN, AND YOUR COLLECTIVE BARGAINING AGENT HAVE THE RIGHT TO SEE AND RECEIVE COPIES OF:

Safety Data Sheets for substances used in the workplace that are on the State Department of Industrial Relations Directors List of Hazardous Substances (Section 339, Title 8, California Administrative Code)

Attached is a list of substances present in this employment which are on the Directors List of Hazardous Substances.

Safety Data Sheets are available at:

Tim Crockenberg

From:

Tim Crockenberg

Copies of General Industry Safety Order 5194 and the Directors List of Hazardous Substances are available at:

3160 Upper Bay Road, Arcata, CA 95521

From:

Tim Crockenberg

NOTE: No employee may be discharged or discriminated against in any way for exercising the rights afforded them under the Hazardous Substances Information and Training Law

Formulated and Compiled by

CALIFORNIA SAFETY TRAINING CORPORATION
2130 Brundage Lane
Bakersfield, CA 93304-2702
PHONE: 661-377-8300 FAX: 661-377-8313

IIPP Approval

The Sun Valley Group is required by law to establish, implement and maintain an effective written Injury and Illness Prevention Program. A copy of this written Injury and Illness Prevention Program is on file at 3160 Upper Bay Road, Arcata, CA 95521 for review by each and every employee. The company expressly reserves the right to update and improve its written Injury and Illness Prevention Program from time to time, in accordance with changes in the law or where employment conditions require such changes. Furthermore, the company expressly reserves the right to implement or discontinue "Incentive Programs" in carrying out the foregoing safety policies and rules.

Lastly, the at-will employment status of employees covered herein shall in no way be affected by the company's progressive disciplinary system implemented pursuant to Labor Code in furtherance of its written Injury and Illness Prevention Program.

Reviewed and approved:

Corporate Management:		Date:	
--------------------------	--	-------	--

COMPANY	ISSUED	MANUAL	SUBJECT
The Sun Valley Group	September, 2019	IIPP	SECTION 1

THIS PAGE INTENTIONALLY LEFT BLANK

COMPANY	ISSUED	MANUAL	SUBJECT
The Sun Valley Group	September, 2019	IIPP	HAZARD COMMUNICATION PROGRAM

Company Name: The Sun Valley Group

Address: 3160 Upper Bay Road, Arcata, CA 95521

1. Person responsible for the Hazard Communication Program:

Tim Crockenberg

2. Inventory of hazardous substances is located at:

3160 Upper Bay Road, Arcata, CA 95521

3. Safety Data Sheets (SDS) for all hazardous substances are located at:

Tim Crockenberg

A copy of the Hazard Communication Standard (GISO 5194) and company program are kept with the SDSs.

4. Employees may review SDSs and the Standard by following this procedure:

Ask Tim Crockenberg

SDSs not on hand which are requested by employees will be requested of suppliers within seven (7) days by letter.

5. The SDS file is updated with new information and new hazards identified by:

Tim Crockenberg

Any new hazards will be reported immediately to:

Tim Crockenberg

All affected employees will be notified within thirty (30) days

6. Containers of hazardous materials entering the facilities will be checked by:

Tim Crockenberg

This will assure that they are properly labeled with the chemical name of the contents, the appropriate hazard warning and the name and address of the supplier or manufacturer. Labels on incoming containers are not to be removed or defaced. Containers without labels will not be accepted.

7. Facility containers of hazardous materials will be labeled with the chemical name and hazard warning. Exceptions must be approved by:

Tim Crockenberg

The following exceptions have been approved: None at present

8. Non-routine tasks involving hazardous materials are: None at present

Procedures for complying with the Hazard Communication Standard for these jobs are the following:
None at present

9. Employee training is provided initially to all employees. This training covers the following areas:

© 2019 CALIFORNIA SAFETY TRAINING CORPORATION	TSVGARC ENGLISH IIPP SEPT 2019	24
---	--------------------------------	----

- a. The basic requirements of the Hazard Communication Standard and their right to information on chemical hazards.
 - b. Our company's program to comply with the Standards and procedures and to follow company programs and SDSs.
 - c. How to interpret and use the labels on containers of hazardous materials.
 - d. The potential physical hazards and health effects of the hazardous substances and how to use SDSs for more information.
 - e. How to handle the hazardous substances safely and other protective measures in place.
 - f. What to do in an emergency, release or over-exposure to the chemicals.
 - g. How the presence of hazardous chemicals can be detected in the work area.
10. This training is documented in the following manner: By roll sheet and individual records, signed and kept in in the employer's files.
11. Records are maintained at the following location:

3160 Upper Bay Road, Arcata, CA 95521

Training concerning new hazards (new chemicals or new information on SDSs) will be provided within thirty (30) days and documented.

12. Periodic refresher training will be provided and documented as follows: Annually by roll sheet and individual records, signed and kept in the employer's files

13. Outside employees (subcontractors and visitors) will be advised of chemical hazards in facility(s) in the following manner:

Verbally from Tim Crockenberg

Contractors will be required to provide information on any chemicals used in our facility as a condition of their contract.

Our company relies on the information contained in SDSs as permitted by the OSHA Hazard Communication Standard and does not perform independent hazard determinations.

Training concerning new hazards (new chemicals or new information on SDSs) will be provided within thirty (30) days and documented. The Sun Valley Group will communicate with employees at the Monthly Safety Meetings and through the Employee Safety Suggestions lock box located in the main office where anonymous or name suggestions can be submitted and received.

14. Communication concerning chemical or physical hazards will be provided as soon as The Sun Valley Group becomes aware of the new chemicals or hazards.

COMPANY	ISSUED	MANUAL	SUBJECT
The Sun Valley Group	September, 2019	IIPP	SECTION 2

THIS PAGE INTENTIONALLY LEFT BLANK

COMPANY	ISSUED	MANUAL	SUBJECT
The Sun Valley Group	September, 2019	IIPP	HEAT ILLNESS PREVENTION

Introduction

California Employers with any outdoor places of employment must comply with the Heat Illness Prevention Standard T8 CCR 3395. These procedures have been created to assist the employer in crafting their heat illness prevention procedures, and to reduce the risk of work related heat illnesses among their employees. These procedures are not intended to supersede or replace the application of any other Title 8 regulation, particularly T8 3203 Injury and Illness Prevention Program (IIPP). Title 8 CCR 3203 requires an employer to establish, implement, and maintain an effective IIPP. The measures listed here may be integrated into the Employer's Injury and Illness Prevention Program.

The employer must also be aware that other standards apply to Heat Illness Prevention such as the requirement to provide for drinking water, first aid and emergency response. **To effectively establish your company procedures, carefully review the key elements listed on this document, as well as the examples provided, then select and fill out the procedures applicable to your workplace. Please use additional paper when necessary. Next, implement and train employees and supervisors on your company procedures.**

Please note: These procedures provide the minimal steps applicable to most outdoor work settings and are essential to reducing the incidence of heat related illnesses. In working environments with a higher risk for heat illness (e.g., during a heat wave, or other severe working or environmental conditions), it is the employer's duty to exercise greater caution and additional protective measures beyond what is listed in this document, as needed to protect their employees. For additional information on preventing Heat Related Illness, please visit the DOSH website at: <http://www.dir.ca.gov/DOSH/DOSH/HeatIllnessInfo.html>.

Heat Illness Prevention Elements

The elements reflected within this Heat Illness Prevention guide are those contained in Title 8 of the California Code of Regulations, Section 3395 (T8 CCR 3395) and consist of the following:

- Provision of Water/Employee Encouragement
- Access to Shade
- Written Procedures
- Training

Regarding this program:

The employer must evaluate each situation for environmental factors which would influence an employee's ability to prevent heat illness.

The employer may eliminate procedures that are not relevant to the workplace or may leave them as a reference (without checking the box) for reference should a new need or heat illness prevention strategy be indicated by new or changing conditions.

Provision of Water

Water is a key preventive measure to minimize the risk of heat related illnesses.

- 3395 (c): Employees shall have access to potable drinking water meeting the requirements of Sections 1524, 3363, and 3457, as applicable, including but not limited to the requirements that it be fresh, pure, suitably cool, and provided to employees free of charge. The water shall be located as close as practicable to the areas where employees are working. Where drinking water is not plumbed or otherwise continuously supplied, it shall be provided in sufficient quantity at the beginning of the work shift to provide one quart per employee per hour for drinking for the entire shift. Employers may begin the shift with smaller quantities of water if they have effective procedures for replenishment during the shift as needed to allow employees to drink one quart or more per hour. The frequent drinking of water, as described in subsection (h)(1)(C), shall be encouraged.

To ensure access to sufficient quantities of potable drinking water, the following steps will be taken:
The company has plumbed fresh, pure, suitably cool water continuously supplied for the use of employees.

The supervisor is responsible for providing 1 quart (4 cups) per person/per hour of clean, suitably cool water to start the day. The supervisor will monitor and refill containers as needed. Monitoring will be at closer intervals as temperature/humidity increases.

The water shall be located as close as practicable to the areas where employees are working and be provided free of charge.

Single use drinking cups will be provided for employee use.

Equipment operators or other vehicle operators will carry a clean water supply with them in or on their vehicle.

If water supplies run low, containers will be replenished by supervisors in a timely manner, so as to allow water to remain on site at all times in quantities as required by law for each employee.

Employee Encouragement

To encourage employees to drink potable water, the following steps will be taken:

Supervisors shall verbally remind employees to drink frequently. These reminders shall be more frequent with elevated temperatures/humidity.

Drinking water will be placed near large crews to facilitate frequent water consumption.

Tailgate meetings will be held each morning to remind employees to drink water frequently. Records of this meeting are recommended.

Heat Potential

The employer will make a reasonable attempt to determine in advance potential heat illness conditions by checking the daily weather forecast prior to starting work.

Supervisors will obtain daily weather information from published news sources (ie: Newspaper, TV/Radio newscasts.)

Supervisors will obtain daily weather information from the National Weather Service at <http://www.nws.noaa.gov/view/states.php?state=ca&map=on>

Access to Shade

Access to rest and shade or other cooling measures are important preventive steps to minimize the risk of heat related illnesses.

- 3395 (d) (1) Shade shall be present when the temperature exceeds 80 degrees Fahrenheit. When the outdoor temperature in the work area exceeds 80 degrees Fahrenheit, the employer shall have and maintain one or more areas with shade at all times while employees are present that are either open to the air or provided with ventilation or cooling. The amount of shade present shall be at least enough to accommodate the number of employees on recovery or rest periods, so that they can sit in a normal posture fully in the shade without having to be in physical contact with each other. The shade shall be located as close as practicable to the areas where employees are working. Subject to the same specifications, the amount of shade present during meal periods shall be at least enough to accommodate the number of employees on the meal period who remain onsite.

Access to shade shall be available at all times, even when the temperature does not exceed 80 degrees (F). When outdoor temperature in the work area does not exceed 80 degrees (F), employers must provide timely access to shade upon an employee's request.

Access to shade shall be of sufficient time to provide for recovery, i.e., no less than five minutes in addition to the time needed to access the shade. Employees who complain of heat-related illnesses shall be closely monitored during recovery periods to ensure their well-being.

All employees are allowed and encouraged to take preventative cool-down rest in the shade. An employee who takes a preventative cool-down rest:

- Shall be monitored and asked if symptoms of heat illness are being experienced.
- Shall be encouraged to stay in the shade.
- Will not return to work until any signs or symptoms of heat illness have abated, but in no event less than five minutes in addition to the time needed to access the shade.

If heat related symptoms are observed while taking a preventative cool-down rest or during a preventative cool-down rest period shall be provided appropriate first aid or emergency response.

Shade material density shall be such that no shadow is cast in the area of blocked sunlight.

Supervisor will provide an adequate number of shade devices which may include: umbrellas, canopies, or other portable devices at the start of the shift and relocate them as needed to be as close to the crew as practicable within a target distance of 2 ½ minutes.

During meal periods the shade provided shall be sufficient to accommodate the number of employees on the meal period who remain onsite.

Tailgate meetings will be held each morning to remind employees of the availability of shade and the importance of cooling rest breaks. Records of this meeting are recommended.

Note: If you use pop-up tents (or other portable shade measures) you need to keep people off of the ground with chairs, benches, sheets etc.

To ensure that employees have access to a preventative recovery period, the following steps will be taken:

Supervisors shall be trained in heat illness prevention, first aid, and emergency response procedures before supervising persons to allow them to better assist potential heat illness victims.

Employees shall be trained in heat illness prevention, first aid, and emergency response procedures to allow them to better monitor fellow workers. (Buddy System)

Supervisors and co-workers will monitor all employees for heat related symptoms.

If heat related symptoms are observed, employees are encouraged to take a break in a designated rest location and to drink water. Employees who are taking heat-related breaks to ensure their well-being shall be monitored by First Aid/CPR trained person or other qualified person specifically trained to provide basic first aid (such as cooling towels, etc.)

Encourage workers who have heat related symptoms to be evaluated by qualified medical personnel before returning to work.

Acclimatization

3395: (b) Definitions:

"Acclimatization" means temporary adaptation of the body to work in the heat that occurs gradually when a person is exposed to it. Acclimatization peaks in most people within four to fourteen days of regular work for at least two hours per day in the heat. (Note: Every person has different physical condition, previous recent work experiences, tolerances to heat, etc. As such, each employee will be dealt with on an individual basis.)

To ensure employees and/or supervisors are properly acclimatized prior to working in potential heat illness conditions, the following steps will be taken:

Employees will be limited in the number of hours per day they spend working in potential heat-illness conditions until they have become acclimated.

An employee newly assigned to a high heat area shall be closely observed by a supervisor or designee for the first 14 days of employment.

All employees shall be closely observed by a supervisor or designee during a heat wave.

For purposes of this section only, "heat wave" means any day in which the predicted high temperature will be at least 80 degrees (F) and at least ten degrees (F) higher than the average high daily temperature in the preceding five days.

Employees shall be trained in heat illness prevention, first aid, and emergency response procedures to allow them to better monitor fellow workers. (Buddy System)

All employees (including supervisors) will pay special attention to symptoms of heat illness which could indicate the need for further acclimatization, especially in un-acclimated employees.

Work requiring chemical-protective clothing will be performed during cooler periods of the day. Chemical-protective clothing can substantially alter the heat-load a person's body is capable of shedding.

A "Heat Index" chart will be utilized to help supervisors/managers better identify potential heat illness conditions in terms of humidity and/or

Temperature. **This chart is a guide, not an absolute. Supervisors are to use common sense in making heat-illness related decisions.**

		HUMIDITY					
		90%	80%	70%	60%	50%	40%
TEMPERATURE	80°	85°	84°	82°	81°	80°	79°
	85°	101°	96°	92°	90°	86°	84°
	90°	121°	113°	105°	99°	86°	84°
	95°		133°	122°	113°	105°	98°
	100°			142°	129°	118°	109°
	105°				148°	133°	121°
110°						135°	
80 - 90 - Fatigue possible with prolonged exposure and activity.							
90-105 - Heat cramps. and heat exhaustion possible.							
105 - 130 - Heat cramps and exhaustion possible, Heat Stroke possible.							
130 + More - Heat stroke likely with continued exposure.							

High Heat Procedures

The following high heat procedures are required for agriculture when the ambient temperature is at 95 degrees F or higher.

3395 (e) (6) When temperatures reach 95 degrees or above, the employer shall ensure that the employee takes a minimum ten minute net preventative cool-down rest period every two hours. The preventative cool-down rest period required by this paragraph may be provided concurrently with any other meal or rest period if the timing of the preventative cool-down rest period coincides with a required meal or rest period thus resulting in no additional preventative cool-down rest period required in an eight hour workday. If the workday will extend beyond eight hours, then an additional preventative cool-down rest period will be required at the conclusion of the eighth hour of work; and if the workday extends beyond ten hours, then another preventative cool-down rest period will be required at the conclusion of the tenth hour and so on.

To ensure effective communication with emergency services supervisors will carry cell phones. These communication devices shall be checked at the worksite for reception prior to beginning each shift. Radios will be utilized to contact a central office in areas where cell phone reception is unreliable. The central office will then coordinate emergency services.

Tailgate meetings will be held each morning to remind employees to drink water frequently, and remind employees of their right to take a cool-down rest when necessary. Records of this meeting are recommended.

One or more of the following will be provided to ensure effective observation and monitoring of employees:

- **Employees/Supervisors alike will use the mandatory "Buddy System" to assist in monitoring each other's physical condition in regard to heat illness conditions.**
- **Supervisors or a central office will maintain regular communication with a sole employee by radio or cellular phone.**
- **Supervisors or designee shall provide observation of 20 or fewer co-workers to monitor all employees for heat related symptoms.**

Supervisors will consistently remind employees to drink plenty of water during high heat times of the day.

One or more employees will be designated at each worksite as authorized to call for emergency services, however all employees are allowed to call emergency services when no designated employee is available.

Supervisors will closely monitor all new employees for the first fourteen days of employment. (Not required if the employee, upon being hired, indicates that he/she has been doing similar work for at least ten of the past thirty days for at least four or more hours per day.)

(In extreme conditions, work will stop for the day.)

Written Procedures

Written procedures help reduce the risk of heat related illnesses, and ensure that emergency assistance is provided without delay.

3395 (i) The employer shall establish, implement and maintain an effective heat illness prevention plan. The plan shall be in writing, in both English and the language understood by the majority of the employees and shall be made available at the worksite to employees and to representatives of the Division upon request. The plan shall, at a minimum, contain: (1) Procedures for the provision of water, (2) High heat procedures (3) Emergency Response Procedures (4) Acclimatization methods and procedures.

This entire document outlines the company written procedures.

All employees and supervisors shall be trained in Heat illness Prevention, these company procedures, and heat-illness related First Aid techniques prior to working outdoors.

Supervisors or designee shall provide observation of 20 or fewer co-workers to monitor all employees for heat related symptoms.

Supervisors and co-workers will monitor all employees for heat related symptoms.

If heat related symptoms are observed, employees are encouraged to take a break in a designated rest location and to drink water. Supervisors are to constantly monitor employees who are taking heat-related breaks to ensure their well-being.

Supervisors will carry cell phones or radios to ensure that emergency services can be called. These communication devices shall be checked at the worksite for reception prior to beginning each shift.

The supervisor will be the designated person available to ensure that emergency procedures are invoked when appropriate.

If worksite is in an isolated or hard to find location and emergency medical response becomes necessary, the supervisor shall designate a lead person with vehicle to the nearest public road intersection in order to lead emergency responders to the site after calling 911. If it is impossible to lead emergency responders to the location, after consultation with emergency responders or other licensed medical personnel, a vehicle will be used to transport the victim to emergency response units.

The supervisor will predetermine emergency responder guidance start point for each work site, and inform employees in the crew of this start point.

GPS coordinates will be given to emergency responders.

Operations requiring chemical resistant overalls shall cease at 80 degrees Fahrenheit in the day and 85 degrees Fahrenheit in the night.

To reduce the risk of heat-related illness and respond to possible symptoms of Heat Illness, the following steps will be taken:

Water will be provided to employees - 1 quart (4 cups) per person/per hour - onsite, or replenishment procedures noted in "Provision of Water" will apply;

Employees will be encouraged throughout the day to drink potable water to stay hydrated.

Employees will be provided access to shade during breaks and recovery periods using the procedures noted in "Access to Shade".

Employees and Supervisors will be trained in: Heat Illness Prevention, Recognition of Symptoms, Heat Illness First Aid, and Emergency Response Procedures.

These procedures will be in writing and made available to all affected employees.

Emergency Response Procedures

To ensure that emergency medical services are provided without delay, the following steps will be taken:

- To ensure effective communication with emergency services supervisors will carry cell phones. These communication devices shall be checked at the worksite for reception prior to beginning each shift. Radios will be utilized to contact a central office in areas where cell phone reception is unreliable. The central office will then coordinate emergency services.
- If a supervisor or employee observes signs or symptoms of heat illness in any employee, the supervisor will take immediate action commensurate with the severity of the symptoms.
- If the signs or symptoms are indicators of severe heat illness, emergency responders will be contacted immediately.
- As soon as possible after the start of the shift/work period, the Supervisor will obtain/draw a site map of the field, including cross-streets and/or GPS coordinates.
- Employees/Supervisors alike will use the mandatory "Buddy System" to assist in monitoring each other's physical condition in regard to heat illness conditions.
- Both Employees and Supervisors shall be trained in heat illness prevention, first aid, and emergency response procedures before supervising persons working outside to allow them to better assist potential heat illness victims. If heat related symptoms are observed, employees are encouraged to take a break in a designated rest location and to drink water.
- Employees exhibiting signs or symptoms of heat illness will be monitored and evaluated and shall not be left alone or sent home without being offered onsite first aid by a qualified employee and/or being provided with emergency medical services.
- If worksite is in an isolated or hard to find location and emergency medical response becomes necessary, the supervisor shall designate a lead person with vehicle to the nearest public road intersection in order to lead emergency responders to the site after calling 911. If it is impossible to lead emergency responders to the location, after consultation with emergency responders or other licensed medical personnel, a vehicle will be used to transport the victim to emergency response units.

Training

Training is critical to help reduce the risk of heat related illnesses and to assist with obtaining emergency assistance without delay.

- **3395 (h) (1) Employee training:** Training in the following topics shall be provided to all supervisory and non-supervisory employees:
 - (A) The environmental and personal risk factors for heat illness.
 - (B) The employer's procedures for complying with the requirements of this standard, including, but not limited to , the employers responsibility to provide water, shade, cool-down rests, and access to first aid as well as the employees' right to exercise their rights under this standard without retaliation.
 - (C) The importance of frequent consumption of small quantities of water, up to one quart (4 cups) per hour, when the work environment is hot and employees are likely to be sweating more than usual in the performance of their duties.
 - (D) The concept, importance, and methods of acclimatization.
 - (E) The different types of heat illness, the common signs and symptoms of heat illness, and appropriate first aid and/or emergency responses to the different types of heat illness, and in addition, that heat illness may progress quickly from mild symptoms and signs to serious and life-threatening illness.
 - (F) The importance to employees of immediately reporting to the employer, directly or through the employee's supervisor, symptoms or signs of heat illness in themselves, or in co-workers.
 - (G) The employer's procedures for responding to symptoms of possible heat illness, including how emergency medical services will be provided should they become necessary.

(H) The employer’s procedures for contacting emergency medical services, and if necessary, for transporting employees to a point where they can be reached by an emergency medical service provider.

(I) The employer’s procedures for ensuring that, in the event of an emergency, clear and precise direction to the worksite can and will be provided as needed to emergency responders.

(h) (2) Supervisor training: Prior to assignment to supervision of employees, training on the following topics shall be provided:

(A) The information required to be provided by section (h) (1) above.

(B) The procedures the supervisor is to follow to implement the applicable provisions in this section.

(C) The procedures the supervisor is to follow when an employee exhibits signs or reports symptoms consistent with possible heat illness, including emergency response procedures.

(D) How to monitor weather reports and how to respond to hot weather advisories.

To ensure employees are trained, the following steps will be taken:

All personnel both supervisory and non-supervisory shall be trained before working or supervising in an outside high temperature condition.

Supervisors shall be trained in heat illness prevention, first aid, and emergency response procedures before supervising persons working outside in high temperature conditions.

Tailgate meetings will be held when there is a high temperature day to advise employees to take extra care.

This company will evaluate the conditions of temperature, humidity and workload (including PPE) for heat illness training prior to starting work.

Training guidance for supervisors and non-supervisory personnel includes but is not limited to:

- Environmental and personal risk factors
- Procedures for complying with the standard
- Importance of frequent consumption of water (four cups per hour)
- Importance of acclimatization
- Different types of heat illnesses along with the symptoms
- Importance of urging employees to report heat illness symptoms immediately
- Procedures for responding to symptoms
- Procedures for directing emergency medical responders to the work site
- Procedures for transporting victims if responders cannot access the victim

Prior to supervision of employees who will be working outdoors, supervisors are to be trained on the following topics:

- All information employees trained on, as listed above
- Procedures to be followed to implement provisions of Title 8, Section 3395
- Procedures to be followed should an employee show symptoms consistent with possible heat illness, including emergency response procedures.

To ensure supervisors are provided training, the following steps will be taken:

Supervisors will be trained in Heat Illness Prevention, Heat Illness First Aid, and Emergency Response prior to being allowed to supervise employees.

© 2019 CALIFORNIA SAFETY TRAINING CORPORATION	TSVGARC ENGLISH IIPP SEPT 2019	34
© 2019 CALIFORNIA SAFETY TRAINING CORPORATION	TSVGARC ENGLISH IIPP SEPT 2019	34

COMPANY	ISSUED	MANUAL	SUBJECT
The Sun Valley Group	September, 2019	IIPP	SECTION 3

THIS PAGE INTENTIONALLY LEFT BLANK

COMPANY	ISSUED	MANUAL	SUBJECT
The Sun Valley Group	September, 2019	IIPP	LOCKOUT/BLOCKOUT /TAGOUT

1. Lock-out/block-out/tag-out (LOBOTO) procedures are essential to prevent accidental movement of machinery or contact with energized electrical equipment.
2. Lock-out is a method of keeping equipment from being set in motion and endangering workers. In lock-out, a disconnected switch, circuit breaker, valve or other energy isolating mechanism is put in the safe, or off position. A device is often placed over the energy isolating mechanism to hold it in the safe position. A lock is attached, so that the equipment can not be energized.
3. Tag-out is the written warning attached to the energy isolating device that is placed in the safe position.
4. All lock-out and tag-out materials are supplied by The Sun Valley Group. Each device must be durable to withstand wear and substantial so it won't come off easily.
5. The Sun Valley Group issues workers authorization to apply lock-out/tag-out with his/her own lock with his/her name, so that anyone is capable of identifying the person who applied it.
6. Two situations that are most likely to need lock-out/tag-out are:
 - a. When you must move or bypass a guard or other safety device and;
 - b. When you must place any part of your body where you could be caught by moving machinery.
7. Other jobs for which lock-out/tag-out should be used are: repairing electrical circuits, cleaning or oiling machinery with moving parts, or clearing jammed mechanisms.
8. It is The Sun Valley Group responsibility to follow this system that has been chosen.
9. Locks and tags by themselves do not de-energize equipment. Attach them only after the machinery has been isolated from its energy sources.
10. Whether the power switch is on or off, energy of some sort is always present in any powered equipment. Energy will be at least one of two types: kinetic energy, which is the force caused by the motion of an object, or potential energy, which is the force stored in an object that isn't moving.
11. Examples of protective engineering are machine guards, electrical disconnects, mechanical stops such as pins and valves and engineering lock-outs which provide automatic protection against human error. Any engineering safety feature can be defeated if you try.
12. Never bypass an engineering lock-out or let a co-worker do so. Never rely blindly on engineering safety features.
13. There are two methods to make sure employees understand the company's lock-out/tag-out procedure:
 - a. Documentation: this written statement of The Sun Valley Group's energy control program.
 - b. Employee training: to help The Sun Valley Group employees understand how to use the energy control program.
14. A self inspection or one conducted by CSTC is to be conducted at least once a year to make sure energy control procedures are being carried out.
15. Energy isolation and lock-out/tag-out are to be applied ONLY by trained employees authorized to perform service or maintenance.
16. Before lock-out/tag-out is applied, all employees who work in the affected area must be notified.
17. The Sun Valley Group control of hazardous energy must be done according to:

- a. Preparation for shutdown: Before turning off any equipment in order to lock or tag it out, you must know the types and amounts of energy that power it must be known, the hazards of that energy and how the energy can be controlled.
 - b. Equipment Shutdown: Shut the system down by using its operating controls. Follow whatever procedure is right for the equipment, so that no one will be endangered.
 - c. Equipment Isolation: Operate all energy isolating devices so that the equipment is isolated from its energy sources. Be sure to isolate all energy sources – including secondary power supplies as well as the main source. Never pull an electrical plug while it is under load. Never remove a fuse instead of disconnecting the electrical source.
 - d. Applying Lock-out/Tag-out Devices: All energy isolating devices, must be locked out and tagged. Only the standardized devices supplied by The Sun Valley Group are to be used for lock-out/tag-out and they are not to be used for anything else. Use the lock-out device if locks cannot be placed directly on the energy control. When the lock-out is used, every employee in the work crew must attach a personal lock. More than one employee can lock-out a single energy isolating device by using a multiple lock hasp. For big jobs, a lock-out box can be used to maintain control over a large number of keys. Attach tags at the same point as the lock or as close to it as possible. **Fill tags out completely and correctly.**
 - e. Control of Stored Energy: Take any of the following steps that are necessary to guard against energy left in the equipment after it has been isolated from its energy sources. Inspect the system to make sure all parts have stopped moving. Install ground wires. Relieve trapped pressure. Release the tension on springs or block the movement of spring-driven parts. Block or brace parts in hydraulic and pneumatic systems that could move from the loss of pressure. Bleed the lines and leave vent valves open. Drain process piping systems and close valves to prevent the flow of hazardous materials. If a line must be blocked where there is no valve, use the blank flange. Purge reactor tanks and process lines. Dissipate extreme cold or heat, (wear protective clothing). If stored energy can re-accumulate, monitor it to make sure it stays below hazardous levels.
 - f. Verify Isolation of Equipment: Make sure all danger areas are clear of personnel. Verify that the main disconnect switch or circuit breaker can't be moved to the "on" position. Use a voltmeter or other equipment to check the switch. Press all start buttons and other activating controls on the equipment itself. Shut off all machine controls when the testing is finished.
18. While performing the work, plan ahead and avoid doing anything that could re-activate the equipment. For example don't bypass the lock-out when putting in new piping or wiring
19. Before removing the lock-out/tag-out, make sure the equipment is safe to operate.
- a. Remove all tools from the work area.
 - b. Be sure the system is fully assembled.
 - c. Safeguard all employees.
 - d. Conduct a head count to make sure everyone is clear of the equipment.
 - e. Notify everyone who works in the area that lock-out/tag-out is being removed.
 - f. Remove the lock-out/tag-out devices. Except in the emergencies, each device must be removed by the person who put it on.
 - g. The last person to remove a lock has extra duties to insure no one is in harms way during restart. Tags should be removed, signed and turned in.
 - h. Follow the checklist of required steps to re-energize the system.
20. Special problems may arise when contractors or other outside workers are performing service or maintenance. They are to follow the onsite LOBOTO program.

21. If it is necessary to temporarily re-activate equipment being worked on:

- a. Remove unnecessary tools from the work area;
- b. Make sure everyone is clear of the equipment;
- c. Remove the lock-out/tag-out devices;
- d. Re-energize the system. As soon as the energy is no longer needed, isolate the equipment and re-apply lock-out/tag-out using the 6-step procedure

RE: Effectiveness of Hazardous Energy Control Procedures Annual Review

To the best of my knowledge, information, and belief formed after reasonable inquiry, the information submitted is true, accurate, and complete in accordance with Title 8 3314.

(Signature) (Date)

(Title)

A complete list of LOBOTO procedures can be found in the main office of The Sun Valley Group.

LOCK OUT, BLOCK OUT, TAG OUT PROCEDURE

Equipment: _____ Date _____

LOBOTO Supervisor Name: _____

LOBOTO Employees Name(s): _____

I) Shut Down Preparation

Type(s) of Energy: (a) _____ (b) _____ (c) _____ (c)

Hazards of Energy: (a) _____ (b) _____ (c) _____

Controls of Energy: (a) _____ (b) _____ _____

II) Equipment Shutdown

Notify Area Personnel

Power off at equipment control switch(es): (a) _____ (b) _____
(c)

III) Equipment Isolation

Disconnect(s) # _____ in OFF position

Lock and/or Lockout device disconnected in off position:

Tag, Name, Date disconnected (standardized tags & locks only)

IV) Control Stored Energy

Parts have stopped moving _____ Grounding
cables/wires have been installed _____ Pressure has
been relieved in all lines/pipes _____ Tension/springs
have been removed or movement otherwise blocked

V) Verify Isolation of Equipment

Personnel out of area _____ Attempt
to start equipment to verify shut down/lock out _____ Return start
switch for equipment set to off position

VI) Perform the Work

VII) Repair/Paint/Replace as set forth in the Repair Schedule

VIII) Remove Lock-Out Block-Out Tag-Out

Remove all tools, parts, & chemicals from the area _____ Verify

ALL equipment controls are in "Neutral" _____ Notify

personnel in the area and make sure the area is clear

Remove LOBOTO devices (The person who applied them is the only person allowed to remove them)

Return Lock-Out locks and devices to Control Area

--	--	--

--	--	--

Pesticide Safety Standard Operating Procedure

ARCATA LAND COMPANY SOP - PESTICIDE SAFETY

Doc. No.:	<u>SOP-OPR-003</u>	Rev.	<u>A</u>
Area:	<u>Arcata Land Company</u>	Date:	<u>3/14/2020</u>
Doc. Owner:	<u>Tim Crockenberg</u>		

1.0 PURPOSE

- 1.1 To explain the safety precautions and rules for storing, mixing, applying and cleaning of the implements used for pesticide applications at the Arcata Land Company (ALC).

2.0 SCOPE

- 2.1 This procedure must be observed by any Team Member handling pesticides, mixing, applying or cleaning. Only certified and authorized Team Members can follow any of the steps described in this procedure.
- 2.2 If you have any doubt about your responsibilities please check and confirm with your Manager before proceeding.

3.0 REFERENCES

- 3.1 Pesticides Safety Data Sheets (SDS)
- 3.1.1 Check the ALC pesticides and chemicals SDS binders available throughout the farm.

4.0 DEFINITION

- 4.1 **Pesticide:** The Food and Agriculture Organization (FAO) has defined pesticide as any substance or mixture of substances intended for preventing, destroying, or controlling any pest, unwanted species of plants or animals, causing harm during or otherwise interfering with the production, processing, storage, transport, or marketing of food, agricultural commodities, wood and wood products or animal feedstuffs. Also used as substances applied to crops either before or after harvest to protect the commodity from deterioration during storage and transport.
- 4.2 **SDS (formerly known as MSDS: Material Safety Data Sheet):** Safety Data Sheet: Document that contains the information on potential health effects of exposure to chemicals or other potentially dangerous substances and on safe working procedures when handling chemical products.
- 4.3 **REI (Restricted Entry Interval):** Is the minimum amount of time that must pass between the time a pesticide was applied to an area or crop and the time that people can go into that area without protective clothing and equipment. Durations of REIs are found on pesticide labeling and in regulations.

- 4.4 **Kleen-it Spray Tank Cleaner:** High concentrated cleaner used to remove pesticide residues from the spray equipment. It is noncorrosive to humans and is safe to use on all internal and external areas of spraying systems. Reduce the chances of cross contamination which could lead to reduced efficacy and other unwanted application results.

- 4.5 **Terminator II:** Is a highly concentrated silicone-based defoamer. Terminator II is specially designed to prevent foam formation in agricultural spray solutions since excessive foam can lead to inconsistent spray applications.

5.0 SAFETY RECOMMENDATIONS

- 5.1 No one is allowed to perform any of the activities described in this procedure if they have not received pesticide safety training and a certification by the ALC Safety Department.
- 5.2 As part of the activity, it is mandatory to entirely read and understand the SDS of the different ingredients to be use for the preparation of the pesticides.
- 5.3 It is mandatory to always follow all the safety precautions described on the SDS.
- 5.4 Anyone involve in the preparation, mixing and application of pesticides, must wear the following Personal Protection Equipment:
- 5.4.1 Boots to protect feet from getting wet with any liquid
 - 5.4.2 Waterproof coverall Tyvek suites, to protect your body from getting contact with the pesticides.
 - 5.4.3 An overall need to be wear over the Tyvek suite to protect your body from the low temperatures of the surrounds.
 - 5.4.4 Eye protection must be worn to protect eyes from any potential splashing of the pesticides
 - 5.4.5 Gloves are required to be wearing to protect your hands.
 - 5.4.6 Half size mask respiratory protection with cartridge filters specific for pesticides and organic materials vapors like the 3M 6001, use in paint spraying, pesticides and agriculture.

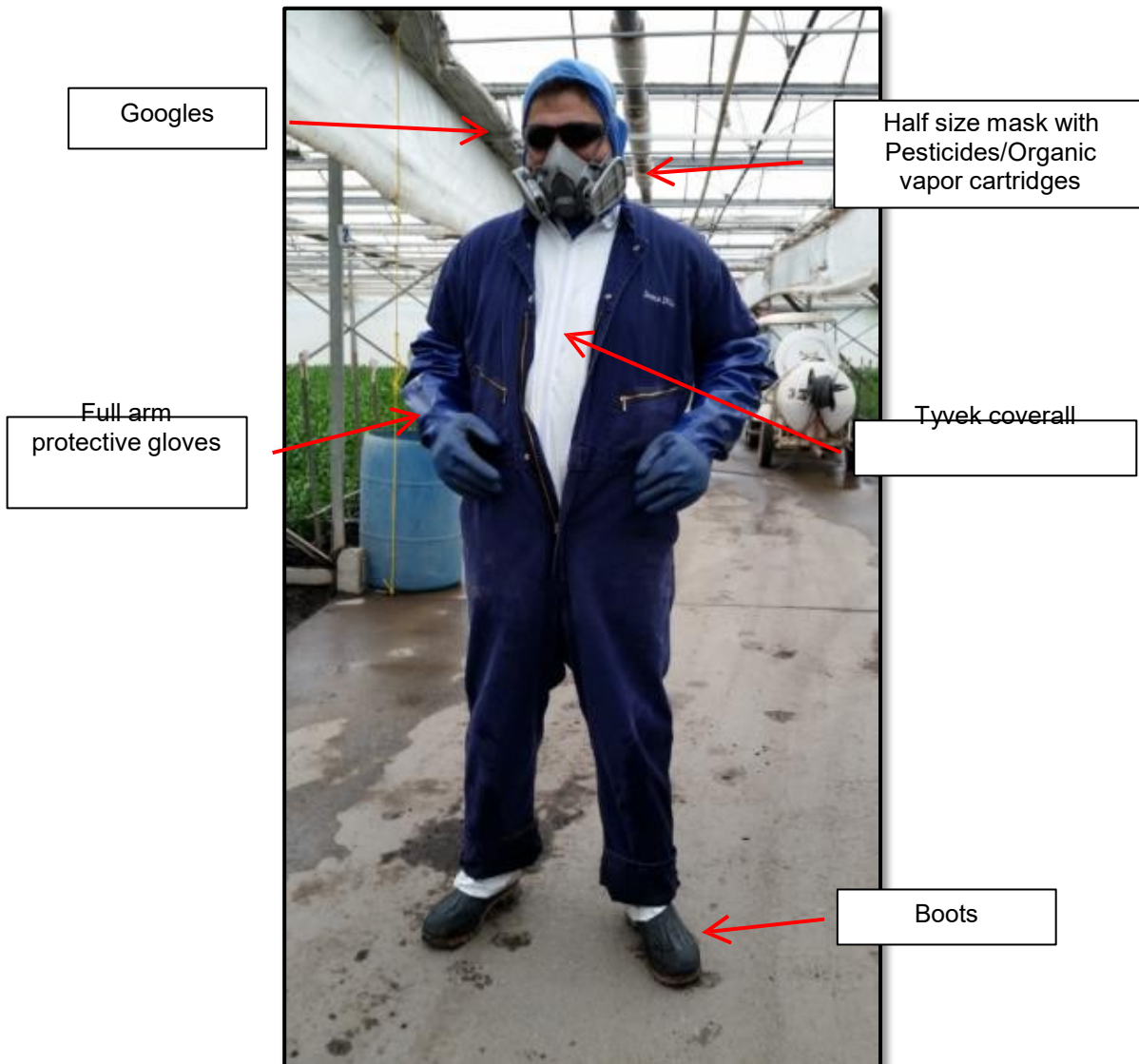

- 5.5 Always keep the area clean and organize and all the chemicals and pesticides well identified and stored.
- 5.6 The use of any electronic device, such as cell phones, computers or portable radios while performing any activity with the use of pesticides is not allowed.
- 5.7 Any Team Members handling, spraying or working with pesticides must take a shower before leaving the farm. There is a designated shower to be used for this group of team members. Use clean cloths.
- 5.8 Used clothes should not be taken home; these should be wash on the washing room dedicated for the Team members using pesticides. Taking cloths or any implement out of the farm may contaminate your surroundings.
- 5.9 Any Team Member hired to be part of the Pesticides Team member group should have a Medical check before any operation to verify that is capable to work with pesticides.
- 5.10 Periodical checks need to be performed and records must be kept in file.
- 5.11 Always wash your hands before eating, drinking smoking, chewing gum or going to the restroom.

6.0 PROCEDURE

6.1 Pesticides are used in agriculture to keep the crops free from pests and disease; **farmers** utilize crop protection products (herbicides, **insecticides**, fungicides, etc.) to help control the thousands of weed species, harmful insects, and plant diseases that can afflict crops.





Gray snow
mold



Fungus

PESTICIDES STORAGE

- 6.2 All pesticides should be stored in a locked container with access only to authorized Team members



- 6.3 Warning/Danger signs should be posted to identify the storage of pesticides
- 6.4 All stored pesticides containers must be identified, properly labeled and properly closed to prevent any spill or scatter.
- 6.5 An eye wash station must be near the premise.



- 6.6 The storage area should have a list off all the stored pesticides and a binder with all the SDS.
- 6.7 The pesticides area should have posted a copy of the “Pest Control Headquarters Inspection Report” with an updated expiration date.

PESTICIDES MIXING

- 6.8 Every day and before starting performing any of the steps described on this procedure, it is mandatory that the Team Members to review the condition of their Personal Protection Equipment (PPE) and the good conditions of the equipment to use. It require filling the “Checklist for sprayers” and submitting this to the Team Lead at the end of the shift.

Checklist for Sprayers/ Lista de checado para Esprayadores

Name/ Nombre: Jesús Diaz Date/ Fecha: 8/8/17

Equipo de Seguridad/Safety Equipment

P.P.E.

Botas/Boots

Oberoles/Coveralls

Lentes de seguridad/Safety Glasses

Guantes/Gloves

Mascara/Respirator

Camisa de manga larga/Long-sleeve shirt

Revisar que no haya Fugas/Check for leaks

Tanque/Tank

Mangueras/Hose

Pistola de esprayar/ Sprayer gun

Firma/Signature: JD

Team Leader Firma/Signature: Rodrigo Patino Date/Fecha: 8/8/17

- 6.9 Not performing the Checklist for sprayer may cause disciplinary action.
- 6.10 The Grower or the Pesticides Team Leader are responsible to determine the pesticide mix and the amount to prepare for the crop to be irrigated.
- 6.11 The pesticides mix ingredients depend on factors like the application purpose (preventive spraying, corrective spraying, herbicides, etc.), the crop to irrigate, the life of the crops, the weather conditions, etc.
- 6.12 A reference table of the pesticides used in the different Sun Valley crops can be observed in the attachments in this procedure in section 9.1.
- 6.13 Obtain the formula mix to prepare from the Grower or the Pesticides Team Member and proceed to prepare the solution.
- 6.14 Remember to wear your PPE (Personal Protection Equipment) before handling the pesticides

Electrical
cable cord

Sprayer hose

Tank



Pump

Sprayer
nozzle





6.15 Take one of the sprayers cart and drive it into the chemicals area.



6.16 Open the tank lid and add 25 gals of well water



- 6.17 After weighing the ingredients to use in the solution preparation, slowly add these into the tank.



- 6.18 Complete the mixture adding the required well water to complete the desired volume of pesticide.
- 6.19 Move the hose back and forth to help the mixing of the added dry pesticides.



- 6.20 Once mixture is completed, close the tank and proceed to the area to spray the prepared solution.



6.21 The Grower or the Pesticides Team Leader is responsible to record the mixture, the tank number and all the related information in the "Pesticides Control" log form.

PESTICIDE CONTROL																
Date	Time	Crop/Location/Acreage	EPA/CA Reg. No.	Total Product Used	REI	Rate per Acreage	Dilution	Product Name	Active Ingredient	Manufactory Name	Applicator Initials	Equipment Used	Weather Conditions	Pest Type	Degree of Damage	
8/18/17	AM 9:00	west 900 to 910	61842 23	5 oz	12 hrs	5 oz	100%	logal doroX	linuron	Nova source	JD	2565	cloudy	-	-	
11	PM 9:00	1 Acre	11	11	11	11	11	11	11	11	11	11	11	11	11	
8/18/17	12:00 PM	cravo lines	61842 23	5 oz	12 hrs	5 oz	100%	logal doroX	linuron	Nova source	JD	2565	cloudy	-	-	
11	12:00 PM	compartent	11	11	11	11	11	11	11	11	11	11	11	11	11	
11	11	1 → 5 1/2 Acre	11	11	11	11	11	11	11	11	11	11	11	11	11	
11	11	11	11	11	11	11	11	11	11	11	11	11	11	11	11	
8/18/17	4:00 PM	9st lines	70051- 66	3 1/2 LB	4 hrs	1 LB	100%	stavelin	Bacillus	certis	JD	2554	cloudy	-	-	
11	4:00 AM	941 to 960 965 to 982 3 1/2 Acre	663803 567690	42 oz	42 oz	12 oz	100%	Desce	Fenoxa	sepro	11	=	=	=	=	

6.22 All documents related to pesticides are auditable by the State of California Department of Pesticides Regulation and by the Environment Protection Authority (EPA); all these documents should be properly filed and maintain.

PESTICIDES SPRAYING

6.23 Isolate the area to be sprayed, with warning signals to prevent the entry to this area by any of the Team members.

6.24 The posted sign needs to include the name of the applied active ingredient and the REI reentry time.



6.25 Park the sprayer in the area.



6.26 Plug the pump to an electrical outlet and extend the spraying hose.



- 6.27 Open the tank and recirculate the mix for around 5 minutes to assure a proper mixture.



- 6.28 Walk thru the grown channels uniformly spraying the pesticide.



CLEANING AND DISPOSAL OF MATERIALS AND CONTAINERS

- 6.29 Do not reuse or refill containers that contained pesticides. **“Triple Rinse”** the container promptly after emptying.
- 6.30 Empty the remaining contents into the application equipment or a mix tank and drain for 10 seconds after the flow begins to drip. Fill the container with water and recap. Shake for 10 seconds. Pour rinsate into application equipment or mix tank or store rinsate for later disposal (Cistern). Drain for 10 seconds after the flow begins to drip. Repeat this process two more times. Then puncture and dispose.

CLEANING OF THE APPLICATION EQUIPMENT (SPRAYERS)



- 6.31 Add 25 gallons of well water to the tank and 4 oz of the “Kleen-it” Spray Tank cleaner (manufactured by Plant Health Technologies PHT).
- 6.32 To prevent the foam formation during mixing and recirculation of the solution, add 1-2 oz of “Terminator II” defoamer.
- 6.33 Recirculate solution for 5 minutes and while recirculating, use the sprayer to spray the inside walls of the tank.



6.34 After the 5 minutes recirculation, drain the solution into the cistern.



6.35 Rinse the tank only with well water for two more times and drain the water into the cistern.

6.36 The tank is ready to be use for a new application.

6.37 The water in the cistern is later pumped into a plastic tote and watered into the field.

7.0 TRAINING

7.1 Every Team Member using pesticides at the ALC should have a refresh course at least once a year, covering the safety precautions and risks of using pesticides, personal protection equipment and the process to perform any of the described operations in this procedure. Team Members should be trained by the ALC Safety Manager or anyone qualified in the subject.

7.2 Any training should be documented and signed by the Trainer and the Team Member. Training records should be kept on file on the Human Resources department.

7.3 This procedure should be reviewed with the Team Members every time that there is a Revision change. A signed training record should be maintained on the Human Resources department.

8.0 RECORD KEEPING

8.1 All training records should be maintained on the Human Resources files.

9.0 ATTACHMENTS

9.1 ALC Pesticides chart

Name	Oriental	Lilies	Brasikas	Tulips (regular)	Fresh Tulips	Iris	Files Iris	Hydreneas	Active Ingredient	Appearance
Agromaicen						X				
Avid								X	Abamectin	Yellow to red brown liquid
Bayleton						X	X			
Calmax	X	X			X	X	X			
Conserve	X	X								
Daconil		X							Chlorothalonil	Light grey viscous liquid
Daconil Ultrex						X	X		Chlorothalonil & Kaolin Clay	Brown granules
Decree	X	X	X	X					Fenhexamid, Lignosulfonic acid, Sodium salt	Granular beige powder
Endeavor	X	X	X	X	X			X		
Endura									Boscalid, Ammonium sulphate	Granules
Exigon								X		
Floramaite										
Iprodione	X	X	X	X		X	X	X	Iprodione	Opaque liquid
Javalin		X	X							
Madallion		X				X	X		Fludioxonil	Beige to brown granules
Palladium				X	X				Cyprodinil	Grey to brown granules
Regalia	X							X	Extract of Reynoutria sachalinensis	Liquid micro emulsion

9.2 Terminator II technical information

Simplot



TechPack

version: Dec2011



Antifoaming and Defoaming Agent

Principal Functioning Agents

Polydimethylsiloxane, silicon dioxide.....	10%
Constituents Ineffective as spray adjuvants.....	90%
TOTAL.....	100%

All ingredients are exempt from the requirement of a tolerance under 40 CFR 180.

General Information

This product is a fast, effective defoamer for use in suppressing foam. Controlling foam reduces filling time and lessens overflow waste. This product improves spray performance. The combination of effective ingredients allows for very fast knockdown of troublesome foam if it should occur in the spray tank.

Use Directions

Shake well before using. This product should be added to the spray mixture before the pesticide or any additional surfactant is added. Agitation is recommended to aid in dispersion of the various components. Add 1 to 2 fluid ounces of this product per 100 gallons of spray mixture. For recirculating sprayers add 4 fluid ounces per 100 gallons of spray mixture. If foam has already occurred, add 6 fluid ounces of this product per 100 gallons of spray mixture. **NOT FOR AQUATIC USE.**

**KEEP OUT OF REACH OF CHILDREN
CAUTION**

Precautionary Statement

CAUTION—Harmful if swallowed, absorbed through the skin or inhaled. Avoid contact with skin, eyes or clothing. Avoid breathing spray mist. Wash thoroughly with soap and water after handling and before eating, drinking, chewing gum or smoking tobacco. Remove and wash contaminated clothing before reuse.

Personal Protective Equipment: Wear chemical-resistant gloves, long-sleeved shirt and long pants, and shoes plus socks.

First Aid

If in eyes: Hold eye open and rinse slowly and gently with water for 15 to 20 minutes. Remove contact lenses, if present, after the first 5 minutes, then continue rinsing eye. Call a poison control center or doctor for treatment advice.

If on skin: Take off contaminated clothing. Rinse skin immediately with plenty of water for 15 to 20 minutes. Call a poison control center or doctor for treatment advice.

If swallowed: Call a poison control center or doctor immediately for treatment advice. Have the person sip a glass of water if able to swallow. Do not induce vomiting unless told to do so by a poison control center or doctor. Do not give anything by mouth to an unconscious person.

If inhaled: Move person to fresh air. If person is not breathing, call 911 or an ambulance, then give artificial respiration, preferably by mouth-to-mouth, if possible. Call a poison control center or doctor for further treatment advice.

Storage and Disposal

Store above 45° F. Storage: Do not contaminate water, food or feed by storage or disposal of this product. Disposal: Do not reuse empty container. Triple rinse (or equivalent) during mixing and loading. Recycling decontaminated containers is the best option of container disposal. The Agricultural Container Recycling Council (ACRC) operates the national recycling program. To contact your state and local ACRC recycler visit the ACRC web page at www.acrcycle.org.

Decontaminated containers may also be disposed of in a sanitary landfill.

DISCLAIMER OF WARRANTIES

Seller warrants that the chemical composition of this product conforms to the chemical description given on this label. THIS WARRANTY IS EXPRESSLY IN LIEU OF ALL OTHER WARRANTIES AND REPRESENTATIONS EXPRESSED, IMPLIED, OR STATUTORY, INCLUDING WARRANTIES OF MERCHANTABILITY AND FITNESS FOR A PARTICULAR USE. Timing, rate and method of application, weather and crop conditions, mixtures with chemicals not specifically recommended on this label or an accompanying written recommendation are beyond the control of seller. Buyer assumes all risks of use, storage and handling of this material not in strict accordance with directions given herewith. Buyer further agrees in the event of damages arising from the use of this product to accept a replacement of the product or a refund of the purchase price of the product, at buyer's option, as full discharge of seller's liability. No one is authorized to make any other warranty, guarantee or directions concerning this product, and no such warranties, guarantees, or directions shall be valid or binding upon seller.

J. R. Simplot Company

P.O. Box 198
Lathrop, CA 95330

P.O. Box 70013
Boise, ID 83707

(800) 635-9444 • www.simplot.com

TERMINATOR II is a trademark of J.R. Simplot Company

CA Reg. No. 7001-50028

Terminator II is available in 1 Qt. bottles

10.0 APPROVEERS

POSITION	NAME	SIGNATURE/DATE
Arcata Farm Manager	Tim Crockenberg	
Arcata Pesticides Team Lead	Rodrigo Patino	
Safety Manager		
CIP Manager	Marisol Marquez	

11.0 CHANGE HISTORY LOG

Rev	DATE	BRIEF DESCRIPTION OF CHANGE	REASON FOR CHANGE
A	August 28, 2017	Standard Operation Procedure Release	N/A

Waste Management Standard Operating Procedure

Title: Waste Management Program

Doc. No.: SOP-OPR-005

Rev. : A

Area: Arcata Land Company

Date: March 14, 2020

Doc. Owner: Tim Crockenberg

1.0 PURPOSE

1.1 To describe the Waste Management Program and policies to be followed by the Arcata Land Company

2.0 SCOPE

2.1 The Arcata Land Company Safety and Environmental Director in conjunction with the Managers of the different areas are responsible for the communication, training and the compliance with the policies and regulations established on this program.

3.0 REFERENCES

3.1 No references available

4.0 DEFINITION

4.1 **Waste:** Unwanted or undesired **material** or substance.

4.2 **Waste management:** the processes involved in dealing with the waste including minimization, handling, processing, storage, recycling, transport, and final disposal. Waste Management encompasses management of all processes and resources for proper handling of waste materials, from maintenance of waste transport trucks and dumping facilities to compliance with health codes and environmental regulations.

4.3 **Environmental Protection Agency (EPA):** The **EPA** is an independent federal agency of the United States federal government, created in 1970, with the mission to set and enforce rules and standards that protect the environment and control pollution.

4.4 **RCRA** is the acronym for the **Resource Conservation and Recovery Act**. It is the federal law that regulates the management of hazardous waste, non-hazardous wastes, medical wastes, and underground storage tanks.

4.5 **Hazardous waste:** A waste that poses substantial or potential threats to public health or the environment. In the United States, the treatment, storage, and disposal of hazardous waste are regulated under the Resource Conservation and Recovery Act (RCRA) and exhibits one of the four characteristics defined in 40 CFR Part 261 Subpart C - ignitability (D001), corrosivity (D002), reactivity (D003), and toxicity (D004 - D043).

5.0 SAFETY RECOMMENDATIONS

- 5.1 Although no Personal Protection Equipment (PPE) is required during the handling of the Biodegradable/Non-Hazardous, it is recommended to use gloves for hand protection and goggles if liquids or oils are handled.

- 5.2 Anyone involve in the handling and disposition of the different waste streams generated in Arcata Land Company needs to be trained on this procedure before performing any of the described activities.
- 5.3 Not following these instructions may incur in sanctions including a job termination.
- 5.4 Always keep the area clean and organize and all the waste materials properly separated and identified.
- 5.5 Thoroughly wash your hand after handling waste materials and before eating, drinking, smoking, chewing gum or going to the restroom.

6.0 PROCEDURE

- 6.1 According to their effect on the Human health and the environment a waste can be classified as:
 - 6.1.1 **Hazardous waste:** Waste with properties that make it potentially dangerous or harmful to. Human health or the environment. Hazardous wastes can be liquids, solids, or contained gases.
 - 6.1.2 **Non-Hazardous waste:** All waste materials not specifically deemed hazardous under federal law are considered nonhazardous wastes. The vast majority of waste produced in the United States is not inherently hazardous. It includes paper, wood, plastics, glass, metals, and chemicals, as well as other materials generated by industrial, commercial, agricultural, and residential sources. Even though these wastes are not defined as hazardous, improper management of them poses significant risks to the environment and human health. Therefore, the handling, transport, and disposal of nonhazardous wastes is regulated by the government, largely at the state and local level. A Non-hazardous substance doesn't have any of the properties listed for the hazardous waste.
- 6.2 According to their material properties, a waste can be classified as:
 - 6.2.1 **Bio-degradable:** Can be degraded (paper, wood, fruits, others)
 - 6.2.2 **Non-Biodegradable:** Cannot be degraded like plastics, bottles, cans, Styrofoam containers and others
- 6.3 According to the Environment Protection Authority (EPA) the generated waste can be classified into one of six waste classes.
 - 6.3.1 **Special waste:** Class of waste that has unique regulatory requirements. Classified under this category are the Clinical and related waste, asbestos waste, Waste tires, anything classified as special waste under an EPA gazettal notice.
 - 6.3.2 **Liquid waste:** Any waste (other than special waste) that: is non-solid and becomes free-flowing at or below 60 degrees Celsius or when it is transported, is generally not capable of being picked up by a spade or shovel and is classified as liquid waste under an EPA gazettal notice.
 - 6.3.3 **Hazardous waste**
 - 6.3.4 **Restricted solid waste:** According to the EPA "Waste Classification Guidelines Part 1" if a waste exceeds the specific contaminant concentration (SCC) and the toxicity characteristics leaching procedure (TCLP) test values specified for general solid waste, the waste must be classified as restricted solid waste and special handling procedures should be taken.

- 6.3.5 **General solid waste (putrescible):** household waste containing putrescible organics, waste from garbage bins collected by the Council, manure, disposable nappies, food waste, animal waste etc.
- 6.3.6 **General solid waste (non-putrescible):** glass, plastic, rubber, bricks, concrete, paper, cardboard, garden waste, synthetic fiber waste, virgin excavated natural material (VENM) etc.
- 6.4 The Arcata Land Company Waste Management program is based on the three “R’s” principle:
 - 6.4.1 **Reduce:** Eliminate or minimize as much as possible the generation of waste
 - 6.4.2 **Reuse:** Reuse or find new ways to use the trash so is not thrown away.
 - 6.4.3 **Recycle:** The process of converting waste materials into new materials and objects. It is an alternative to "conventional" waste disposal that can save material.
- 6.5 Arcata Land Company policy is to Reduce, Reuse and Recycle materials as possible to minimize the waste generation.
- 6.6 Arcata Land Company waste generation goal is to show an annual reduction of 10% of the actual generation quantities.



6.7 Arcata Land Company waste streams projected to be generated:

Waste	Source	Waste classification	Average Annual generation	Disposition Method
Green waste		Biodegradable / Non-hazardous	8,000 tons	Compost
Wood	Wood pallets, wood totes	Biodegradable / Non-hazardous	4 tons	Repair, reuse and wood disposal
Cardboard	Ship boxes, packaging materials	Biodegradable / Non-hazardous	2 tons	Recycling company
Plastic	Hoops plastic covers, drip tapes, plastic pots.	Non-Biodegradable / Non-hazardous	5 tons	Bailing of plastics and recycle of materials
Batteries	Forklifts, Tenco's, alkaline batteries	Non-Biodegradable / Hazardous	50 batteries	Exchange cores with vendors. Proper disposal of the alkaline batteries.
Scrap metals	Machine shop, obsolete equipment	Non-Biodegradable / Non-hazardous	2 tons	Arcata Scrap and Savage
Tires	Farm vehicles	Non-Biodegradable / Hazardous	16	Tires are sent for recycle to TP Tire/Les Schaub in Arcata CA.
Light bulbs	Illumination	Non-Biodegradable / Hazardous	500 per year	Waste Management Inc.
Glass	Greenhouse panels	Non-Biodegradable / Non-hazardous	2 tons	Humboldt Recycling
Agrochemicals	Fertilizers and pesticides	Non-Biodegradable / Hazardous	Minimal generation	Humboldt waste Management in Eureka
Waste Oil	Machinery and equipment, farm tractors and vehicles	Non-Biodegradable / Hazardous	none	Asbury Environmental
Barrels that contained chemicals	Containers that contained chemical materials such oils, fertilizers, and hydronic conditioners.	Non-Biodegradable / Hazardous	20 barrels a year	Return to vendors getting deposit back, these are stored until completing a truck load to ship these back
General Garbage	Lunchrooms, restrooms, offices, etc.	Biodegradable / Non-hazardous	30 Tons	Land field

GREEN WASTE

- 6.8 Green waste or agricultural waste is a Biodegradable/Non-Hazardous waste that can be composed such flowers cuttings, leaves and hedge trimmings.
- 6.9 The green waste due to its biodegradable nature doesn't represent a contamination to the fields; other ways contribute to the enrichment with nutrients to the soil that can be reused for planting.
- 6.10 The green waste totes or bins from the production areas cannot be mixed with any other materials like plastics (bags, gloves, bottles, etc.), rags, food scraps, hazard waste or chemicals, etc., any green waste container mixed with other waste materials should be returned back to the respective area for them to sorted out and remove the non-green waste materials.

WOOD

- 6.11 Wood waste is generated from unusable pallets or totes received from vendors with different purchased materials.





- 6.12 As part of the Arcata Land Company recycling philosophy has established a pallets recycling program.
- 6.13 Pallets that can be reused and are in bad shape get repaired and reused to move materials around the farm.



- 6.14 If a pallet cannot be repaired, this is disassembled, the nails removed and the wood sent for recycling to:

EEL RIVER RESOURCE RECOVERY
965 Riverwalk Dr.
Fortuna, CA 95540
Tel: (707) 725-5156

- 6.15 Arcata Land Company annually repairs broken pallets which are reused. This program reduces the amount of waste wood generated and saves the company money preventing to order additional pallet.

CARDBOARD

- 6.16 Cardboard waste is generated from the box packages of different materials that are received in Arcata Land Company and/or damaged boxes coming from the packaging area.
- 6.17 Cardboard waste is keep separated in totes or wood pallets, then after these are consolidated in a big container that is recollected by a recycling company.



- 6.18 Cardboard boxes should be flattened before disposing into a container to reduce the volume of the waste and to optimize the space of the containers.
- 6.19 Cardboard is sent for recycling to:

HUMBOLDT SANATION & RECYCLING
2585 Central Ave.
McKinleyville CA 95519
Tel: (707) 839-3285

- 6.20 Arcata Land Company reuses cardboard boxes
- 6.21 Pre-pack bunches boxes are kept in inventory until the product is used to ship to the customers, boxes are reused until there are not usable anymore.

PLASTICS

- 6.22 Plastics waste is generated mainly by 3 different streams: Hoops plastics covers, Water dripping tape and plastic pots.



6.23 These are kept separated in containers and get bailed to be sent to recycle to:

RECYCLE ME/GO GREEN RECYCLE

7360 N. Woodrow Ave.
Fresno, CA 93720
Tel: (559) 777-0916



BATTERIES

- 6.24 Batteries are generated from two streams, the ones generated from the forklifts and Tenco's and the waste batteries coming out of the electronic equipment as PH Meters, Inventory scanners, etc.
- 6.25 Large batteries are exchanged as cores every time that a unit is replaced on any forklift or Tenco.



6.26 Batteries can be exchanged with Napa Auto Parts or Pape Forklift group:

PAPE MATERIAL HANDLING

2736 Jacobs Ave.
Eureka, CA 95501
Tel: (707) 443-3015

- 6.27 Batteries cannot be disposal on any of the containers; a well identified temporal container can be used to store the bad batteries before exchanging these with new ones.
- 6.28 Disposing batteries in an unauthorized way is against the environmental and ecological regulations.
- 6.29 Alkaline batteries like the ones coming from remote controllers, PH and temperature meters, etc. these are collected in a well identified container and dispose with an authorized company.



Alkaline Batteries

SCRAP METALS

6.30 Scrap metals are mainly generated in the machine shop, these are collected in a well identified container and send for recycle to:

ARCATA SCRAP AND SAVAGE

192 S G St
Arcata, CA 95521
Tel: (707) 822-4881

TIRES

- 6.31 Waste tires are highly regulated by the Federal and State environmental authorities, tires can hold water and as such, can create a breeding area for mosquitoes, including the Culex mosquito that transmits the West Nile Virus. Tires are often targeted as the prime candidates for mosquito breeding because it is difficult to remove water from them, and they retain heat, which further exacerbates the conditions that attract mosquitoes.
- 6.32 Tires have potential for tire fires which produce acid smoke harmful to humans and the environment as well as leaves behind an oily residue.
- 6.33 All states, except for Alaska, have specific management and disposal rules that apply to generators of waste tires. The purpose of the waste tire regulation is to avoid improper storage and disposal of scrap tires while simultaneously encouraging recycling.
- 6.34 Arcata Land Company disposal the waste tires in:

TP TIRE/LES SCHAUB
1265 Giuntoli Ln.
Arcata, CA 95521
Tel: (707) 822-5191

LIGHT BULBS

- 6.35 Light bulbs are generated from the defective bulbs discarded from the offices or the entire Arcata Land Company Farm.
- 6.36 These are kept in a well identified container; no other materials should be place in this container.



- 6.37 Light bulbs are fragile; the disposition of these should be done carefully to prevent these from breaking.
- 6.38 Compact fluorescent light bulbs (also known as CFLs), Fluorescent tubes and other bulbs may contain mercury, there the importance of preventing them from breaking.
- 6.39 Light bulbs are sent to Waste Management Inc. for disposal

GLASS

- 6.40 Glass is generated from broken greenhouse windows or panels; these are keep separated in tote containers and send for disposal to:

HUMBOLDT SANATION & RECYCLING

2585 Central Ave.
McKinleyville CA 95519
Tel: (707) 839-3285

AGROCHEMICALS

- 6.41 If necessary, agrochemicals can be taken to the following location for proper disposal:

HUMBOLDT WASTE MANAGEMENT

1059 W. Hawthorne St.
Eureka CA 95501
Tel: (707) 268-8680

WASTE OIL

- 6.42 Waste oil is considerate as a Non-Biodegradable/Hazardous Waste; this is generated from the maintenance of the machines, hydraulic equipment, forklifts, tractors and compressors and other equipment.
- 6.43 Waste oils are stored in metallic container well identified and disposal by:

ASBURY ENVIRONMENTAL

200 Dinsmore Dr.
Fortuna CA 95540
Tel: (310) 886-3400

- 6.44 The waste oil container needs to be properly closed when is not in use to prevent the spilling of materials.
- 6.45 Waste oils need to be maintained in hazardous waste storage, covering all the requirements specified for these.

BARRELS THAT CONTAINED CHEMICALS

- 6.46 Barrels generation comes from the boiler chemicals (water treatment) and phosphoric acid (fertilizers).
- 6.47 Barrels are stored and returned to vendors to receive deposit.

GENERAL TRASH

- 6.48 Any other wastes not listed in those described above are considered as general waste or garbage.
- 6.49 General waste is disposal in land fields reason why not all the materials can be thrown in these containers.
- 6.50 There are certain items that cannot be throw in a dumpster, these because the items in question are potential contaminants to the environmental:
- 6.50.1 Tires
 - 6.54.2 Paint cans and lacquers

- 6.50.3 Adhesives
- 6.50.4 Any type of batteries
- 6.50.5 Hazardous materials
- 6.50.6 House hold cleaners
- 6.50.7 Inks
- 6.50.8 Printers toners cartridges
- 6.50.9 Electronic waste or e-waste (computers, televisions, etc.) cannot be thrown away in the garbage; the law prevents heavy metals, acids and other hazardous materials from ending up in soil and drinking water.

6.51 General trash or garbage is handled by:

RECOLOGY ARCATA

30 S St.
Arcata CA 95521
Tel: (707) 822-5951

7.0 TRAINING

- 7.1 The Arcata Land Company Waste Management Program training is part of the new hires induction
Program taught by the Human Resources Department.
- 7.2 Every Manager of the area should follow up with his/her Team Members the compliance with the Arcata Land Company Waste Management Program
- 7.3 The Arcata Land Company Management Program should be part of the Safety topics of the week program.
- 7.4 Arcata Land Company should keep training records signed by the Trainer and the Team Member about the knowledge of this program.
- 7.5 This procedure should be reviewed with the Team Members every time that there is a Revision change. A signed training record should be maintained on the Human Resources department.

8.0 RECORD KEEPING

- 8.1 Training records should be maintained on the Human Resources files.

9.0 APPROVEERS

POSITION	NAME	SIGNATURE/DATE
Arcata Farm Manager	Tim Crockenberg	
Safety Manager		
CIP Manager	Marisol Marquez	

10.0 CHANGE HISTORY LOG

Rev	DATE	BRIEF DESCRIPTION OF CHANGE	REASON FOR CHANGE
A	3/14/2020	Standard Operation Procedure Release	N/A

CalCannabis Cultivation Licensing Waste Management Plan

Non-Cannabis Waste

Non-cannabis wastes will include empty soil, soil amendment, and fertilizer bags, empty plant pots or containers, and typical refuse. Refuse will be sorted to divert recyclables such as paper, plastic, glass, and metals from the waste stream and taken to a recycling center. The remaining solid wastes will be collected and deposited into a solid waste receptacle for temporary storage, which will be kept covered. The solid waste will be removed from the site as needed and disposed of at an authorized waste transfer facility. The solid waste receptacle will be sized appropriately for the volume of waste generated and may be adjusted in size periodically as conditions warrant. It is anticipated that no more than one dumpster per week will be needed.

Cannabis Waste

Cannabis waste will include stems, stalks, degraded cannabis plant material, and general cannabis biomass. Cannabis waste will be managed through either or a combination of on-site composting and off-site disposal by properly licensed collection and processing providers. collection and processing by a local agency, a waste hauler franchised or contracted by a local agency, or a private waste hauler permitted by a local agency.

For on-site composting, cannabis waste will be stored and managed in a designated compost management area at the site. Composting activities will be conducted in accordance with local and state regulations covering composting activities.

For off-site disposal, collection and processing will be performed by a local agency, a waste hauler franchised or contracted by a local agency, or a private waste hauler permitted by a local agency. The cannabis waste will be made unusable and unrecognizable ("destroyed") prior to leaving the site through a County approved method involving either grinding and/or mixing with other plant materials for composting, or grinding and incorporating the cannabis waste with approved non-consumable solid wastes such that the resulting mixture is at least 50 percent non-cannabis waste.

Recordkeeping

Records of destroyed cannabis waste will be kept and cross-referenced by batch number and SKU and/or another unique identifier. The weight or volume, as appropriate, will be recorded along with the method of disposal.

CalCannabis Cultivation Licensing Pest Management Plan

Cultural Pest-Management Control Methods

In order to prevent and mitigate any pest infestations we will utilize a number of culture controls to make the crop and/or habitat unacceptable to pests and reduce the survival of any pests on crops by enhancing natural enemies to likely pests through our Integrated Pest Management ("IPM") program. We will use cultural controls such as plant design and management with our plant density and spacing, timing of seeding and planting / proper maintenance of our cultivation area (clean borders, weed control, sanitation) and crops (i.e. pruning, defoliation).

Biological Pest-Management Control Methods

The use of biological controls at the cultivation facility is integral to our pest management program that includes the use of cultural, biological, and beneficial organisms to control plant pests. The use of predators, such as *Neoseiulus californicus*, as a free-living species will be deployed to consume pests as an alternative to chemical pest-management methods.

Chemical Pest-Management Control Methods

State of CA approved agricultural chemicals (pesticides / fungicides) would be applied to the cannabis plants to control pests and mold. Approved chemicals would be applied at agronomic rates according to manufacturer's specifications. The harvest plan is designed to be a sustainable agricultural operation with limited use of chemical pesticides.

Chemical(s) to Be Applied at any Stage of Plant Growth

Product Name	Active Ingredient(s)
PureCrop1	Soybean oil (10%), Corn oil (5%)
Regalia	Extract of <i>Reynoutria sachalinensis</i> (5%)
Javelin	<i>Bacillus thuringiensis</i> , subspecies <i>kurstaki</i> strain SA-11, and Lepidopteran (85%)
	***Potentially other comparable State of CA approved pesticides

Attach additional sheets of paper as needed.



Reference: 017062.100

June 12, 2020

Rudolf Visser
Arcata Land Company, LLC
3318 Foster Avenue
Arcata, CA 95521

Subject: Onsite Septic Suitability Investigation and Sewage Disposal System Design Recommendations, Arcata Land Company, LLC, Arcata, California; Parcel D, Portion of Assessor Parcel Number 506-231-011–Revision 1

1.0 Introduction

This report summarizes the results of an assessment of soil and groundwater conditions conducted by SHN and provides recommendations for the siting and design of an onsite sewage disposal system at the above-referenced project location. The project site vicinity is provided in Figure 1. Included with this report are the design specifications for a low-pressure, shallow distribution system with a hydraulic capacity of up to 4,060 gallons per day (gpd). The hydraulic capacity of the system was determined based on a maximum of 116 employees per day at the facility during peak production periods.

The location of the proposed disposal field was chosen by the client to maximize the area available for construction of greenhouses and cultivation operations as shown on Figure 2, "Plot Plan for Arcata Land Company LLC," prepared by Kelly-O'Hern Associates and dated March 2020. The scope of the current field investigation included percolation testing and laboratory textural analysis of soils collected from the percolation test pits at the locations shown in Figure 3.

SHN's design of the wastewater disposal system is based on soil textural analysis and percolation test data from the current project site in conjunction with data obtained from previous site investigations on the subject parcel and adjoining parcel to the east (APN 507-181-007). As part of these site investigations, SHN installed observation wells during the Humboldt County wet weather testing period to collect depth-to-groundwater measurements, installed backhoe test pits to characterize the soil profile and determine the depth to limiting conditions, performed percolation testing to determine soil application rates of wastewater, and performed laboratory textural analysis of soil samples collected from the test locations. The data obtained from these investigations are provided with this report as Appendix 1 for reference.

2.0 Project Description

2.1 Background

Arcata Land Company, LLC, is proposing to convert the site into an agricultural production and processing facility. Multiple greenhouses will be constructed



Path: \\220.100.100.5\Projects\2017\017062-ArcataLandCo\100-Leachfield\GIS\PROJ_MXD\Figure1_ProjectLocationMap.mxd User Name: ctipp DATE: 5/7/20, 2:45PM

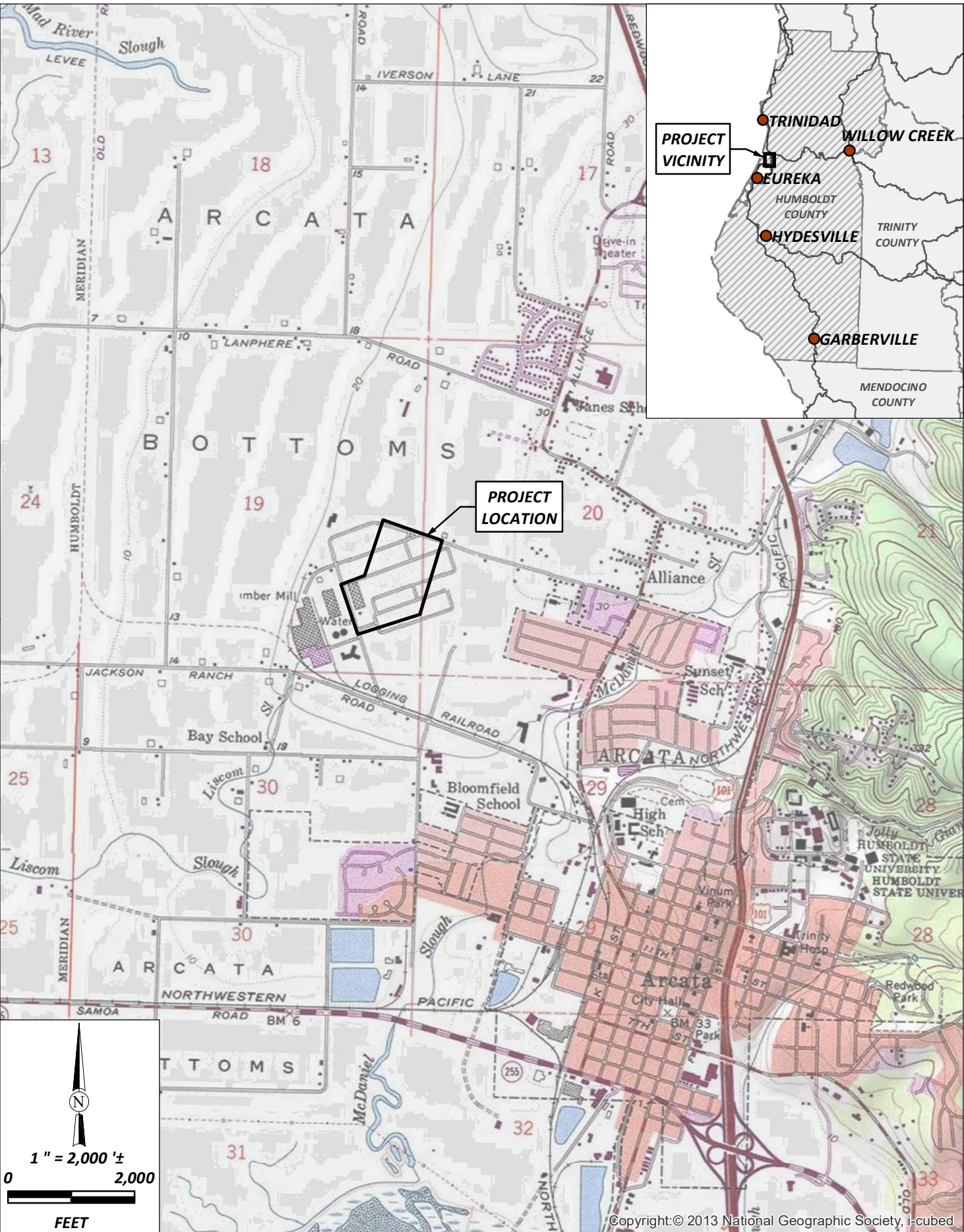

Copyright:© 2013 National Geographic Society, i-cubed



Arcata Land Co
 Onsite Septic Suitability Study
 Arcata, California

May 2020

Project Location Map

SHN 017062.100

Figure 1

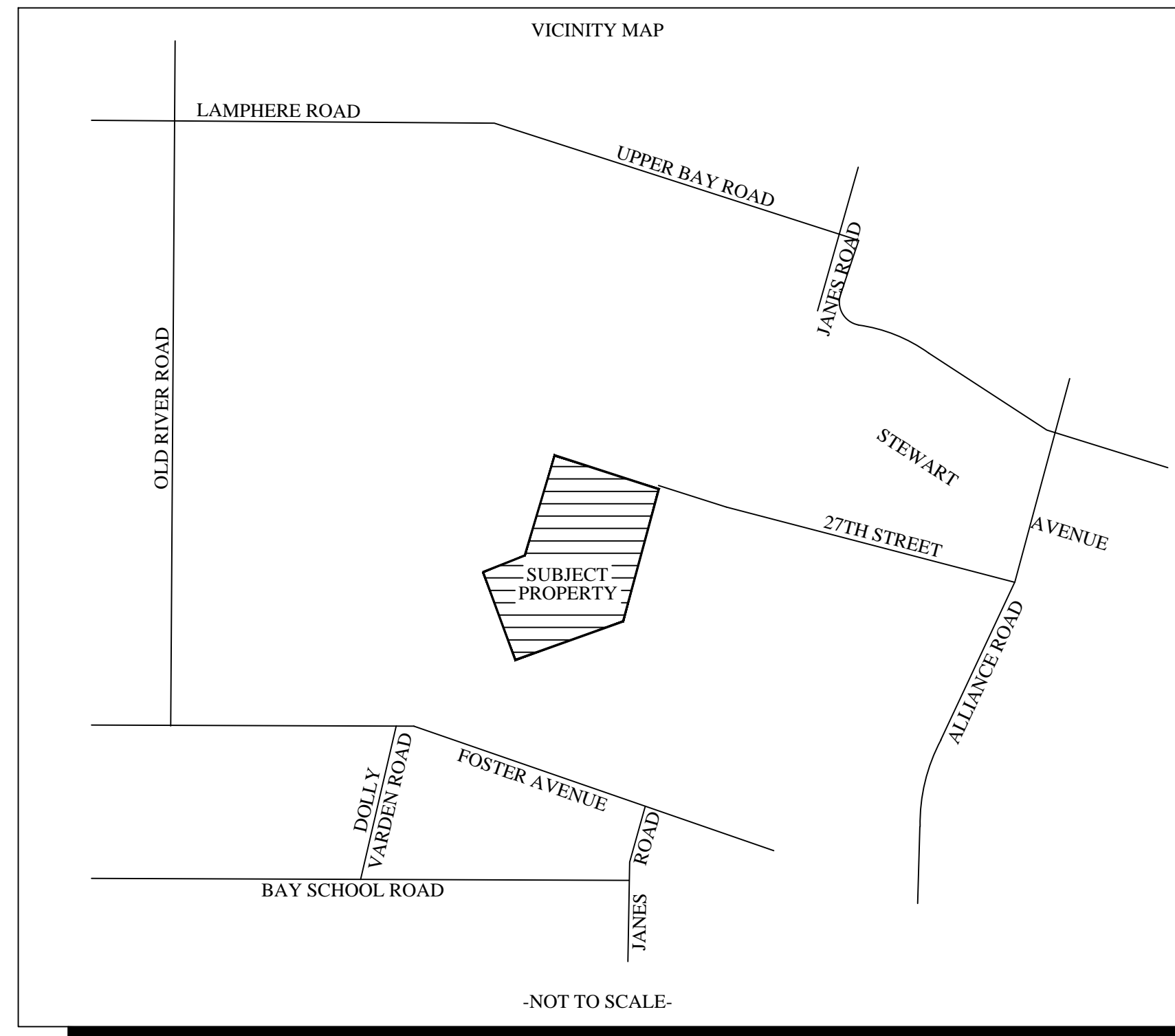

NOTES

- ZONING: MH-Q (HEAVY INDUSTRIAL-QUALIFIED)
- ACCORDING TO FLOOD INSURANCE RATE MAP NO. 06023C0690F, WITH A DATE OF IDENTIFICATION OF NOVEMBER 4, 2016, FOR COMMUNITY NUMBER 060060 IN HUMBOLDT COUNTY, STATE OF CALIFORNIA, A PORTION OF THE SUBJECT PROPERTY IS LOCATED WITHIN FLOOD ZONE A (WITHIN A 100-YEAR FLOOD ZONE) AND A PORTION IS LOCATED WITHIN FLOOD ZONE X (AREAS OF MINIMAL FLOODING). THE APPROXIMATE LOCATION OF THE LINE BETWEEN ZONE A AND ZONE X HAS BEEN LOCATED PER SAID FLOOD INSURANCE RATE MAP NO. 06023C0690F.
BASED ON FEMA CASE NO. 98-09-088A, REVALIDATED BY CASE NO. 11-09-0847V EFFECTIVE JUNE 22, 2017, ARCATA LAND COMPANY PARCELS ARE NOW IN ZONE X, OUTSIDE OF ZONE A.
- THE PROPERTY LINES SHOWN ON THIS PLOT PLAN ARE BASED ON BOOK 64 OF SURVEYS, PAGES 111 & 112. PARCEL LETTERS SHOWN HEREON ARE PER A LOT LINE ADJUSTMENT THAT IS CURRENTLY IN PROGRESS.
- DIRECTIONS OF RUNOFF ARE PER AERIAL MAPPING AND ARE APPROXIMATE.
- THIS PROPERTY MAY BE ENCUMBERED BY THE FOLLOWING RECORDED INSTRUMENTS:

1	BOOK 251 DEEDS, PAGE 372 - EASEMENT GRANTED TO PACIFIC GAS AND ELECTRIC COMPANY FOR PUBLIC UTILITIES - SHOWN HEREON.
---	--
- NO MAJOR VEGETATION REMOVAL PROPOSED.
- PROPOSED 2 FEET OF FILL ON PROPOSED CULTIVATION AREA.
- THERE ARE NO SCHOOLS, SCHOOL BUS STOPS, PLACES OF WORSHIP, PUBLIC PARKS, OR TRIBAL CULTURAL RESOURCES WITHIN 600 FEET OF THE CULTIVATION SITE.
- THERE ARE NO OFF-SITE RESIDENCES WITHIN 300 FEET OF CULTIVATION SITE.
- THERE ARE NO PERENNIAL & INTERMITTENT WATER COURSES (RIVERS, CREEKS, ETC.), ENGINEERED OR NATURAL PONDS, AND/OR WETLAND AREAS.
- ACCESS TO THE SUBJECT PROPERTY IS VIA A PROPOSED EASEMENT ACROSS PARCEL C FROM FOSTER AVENUE, SHOWN HEREON. FOSTER AVENUE IS A COUNTY MAINTAINED ROAD WITH AN ASPHALT-PAVED ROAD SURFACE OF 20 FEET IN WIDTH, WITH A GRADUAL GRADE.
- WATER SOURCE IS A WELL LOCATED ON THE PROPERTY TO THE SOUTH AS SHOWN HEREON.
- THERE ARE NO WATER DIVERSIONS ON THE SUBJECT PROPERTY.
- POWER WILL BE VIA CO-GENERATION, LOCATION TO BE DETERMINED.

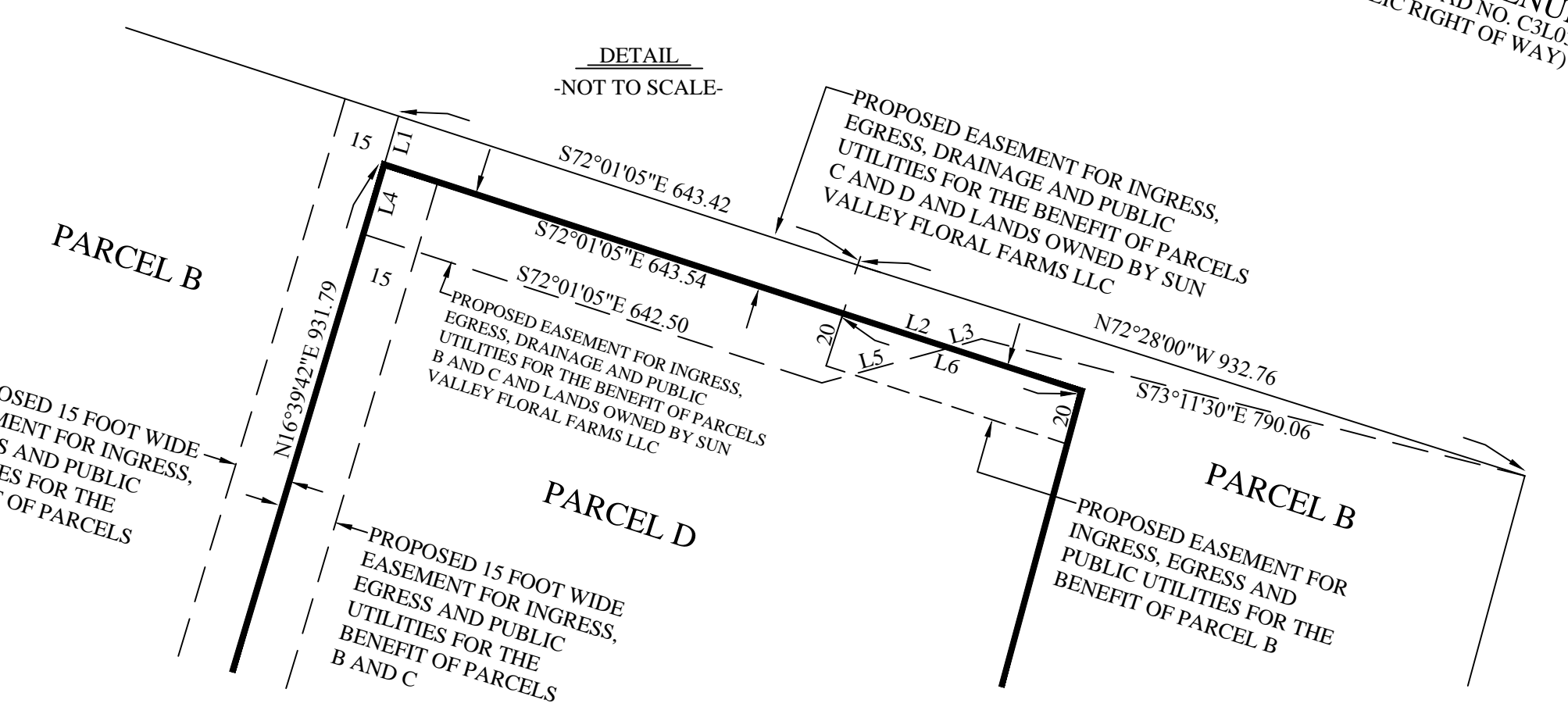
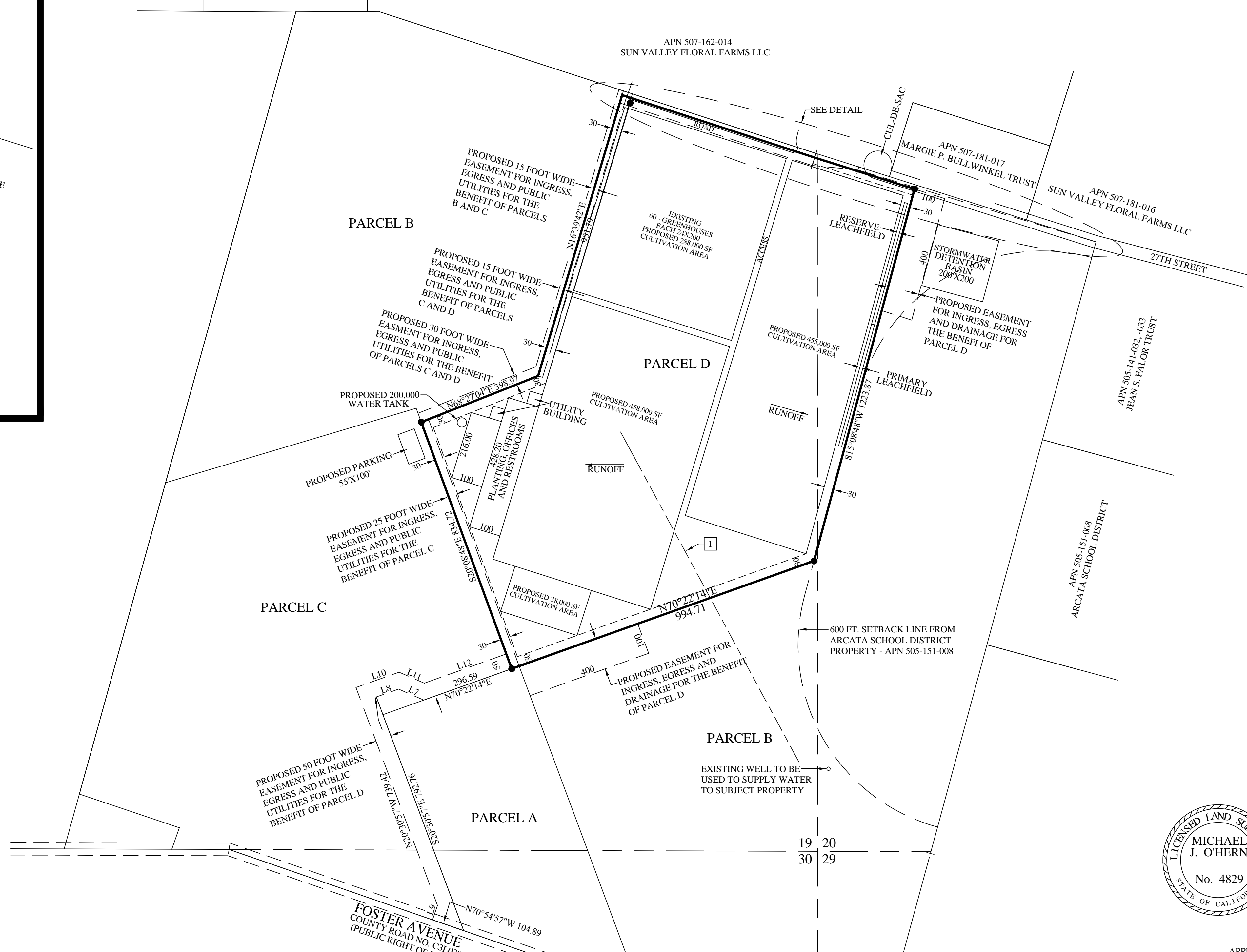

LINE TABLE

LINE	BEARING	DISTANCE
L1	S16°39'42\"/>	



PRELIMINARY
MICHAEL J. O'HERN L.S. 4829

APPLICANT: ARCATA LAND COMPANY LLC
C/O LANE DEVRIES
3318 FOSTER AVENUE
ARCATA, CA 95521
(707)825-4700

APN 505-151-003 (PORTION OF)
APN 506-231-011 (PORTION OF)
APN 507-181-007
PLOT PLAN
FOR
ARCATA LAND COMPANY LLC
IN
SECTIONS 19, 20, 29 & 30 T6N, R1E, HUMBOLDT MERIDIAN
IN THE UNINCORPORATED AREA OF HUMBOLDT COUNTY
MARCH 2020 SCALE 1" = 200'

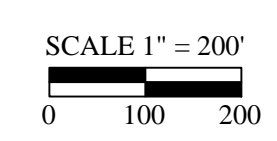

HUMBOLDT COUNTY
STATE OF CALIFORNIA
KELLY-O'HERN ASSOCIATES
EUREKA, CALIFORNIA

Figure 2

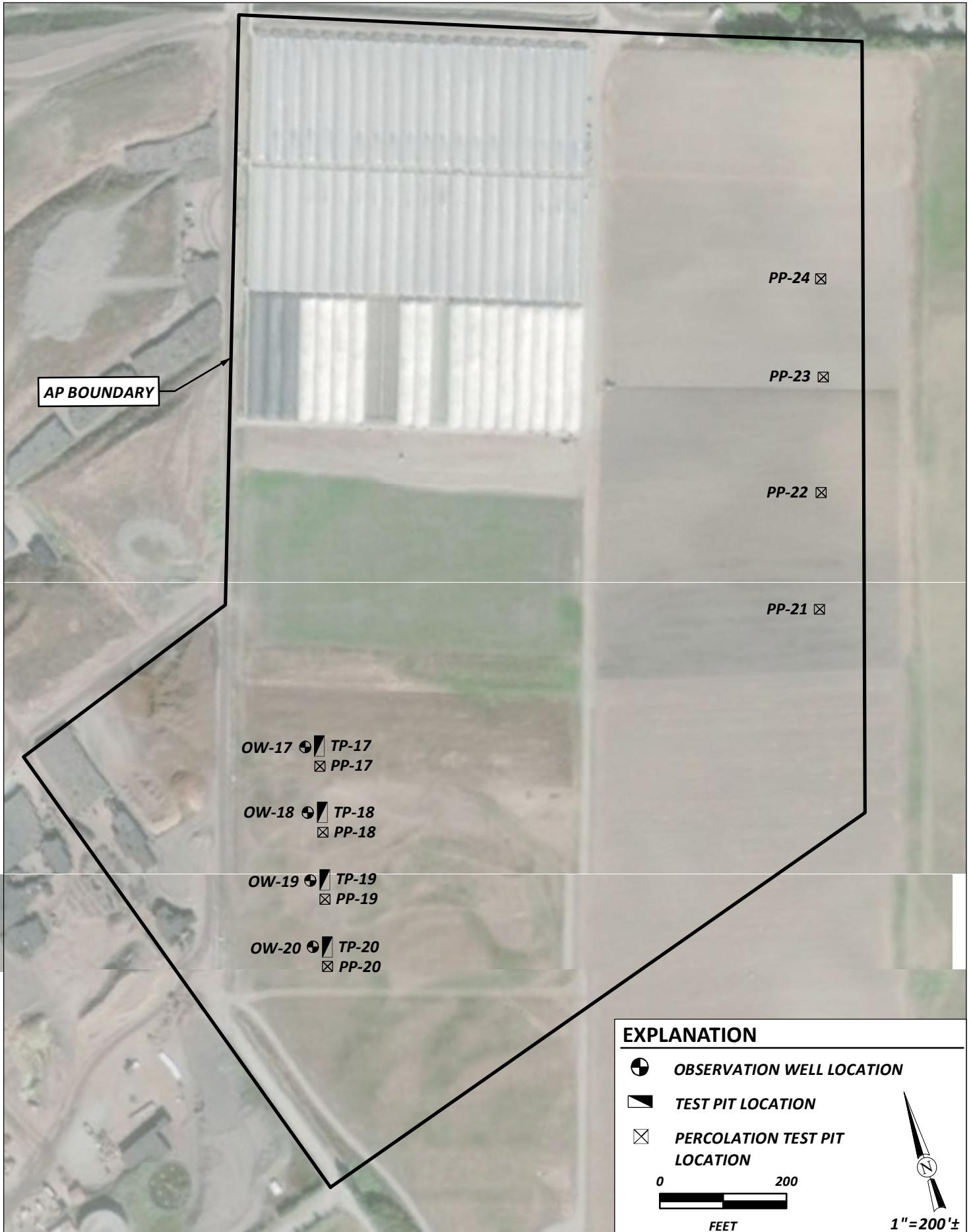

Arcata Land Co
 Onsite Septic Suitability Study
 Arcata, California

May 2020

Site Map showing Test Locations

SHN 017062.100

Figure 3

within the open pasture to the west of the proposed disposal field area as shown in Figure 2. The facility will employ up to 116 full-time workers. The worker's bathroom facilities are expected to contain toilets, wash stations, and showers.

The proposed wastewater storage and disposal system is sized to accommodate daily wastewater flows of up to 4,060 gpd. SHN's design is conservatively based on a per person water demand of 35 gpd based on Appendix C-"Expected Daily Wastewater Flows," for factories contained in the *Humboldt County Onsite Wastewater Treatment System (OWTS) Regulations and Technical Manual*, dated November 7, 2017.

The proposed wastewater storage and pumping system will consist of a new 12,000-gallon dual-compartment septic tank and new 4,000-gallon single-compartment pump vault. Effluent will be disposed of in a new subsurface disposal field consisting of a low-pressure pipe-distribution system with a total of 2,240 lineal feet of pressurized distribution lateral contained within shallow gravel-filled trenches. The pressurized distribution system is to be split into four separate distribution cells connected to an automatic distributing valve.

The proposed system is intended to provide for the disposal of low-strength wastewater generated by employee restrooms and break rooms, only. The system is not adequate for high-strength wastewater generated by a commercial kitchen or cafeteria waste, process water, and equipment wash water containing cleaners or solvents.

2.2 Field and Laboratory Investigation

As part of the current site investigation, a project geologist from SHN conducted four percolation tests on March 13, 2020, at the locations shown in Figure 3. Stabilized percolation rates were obtained for the upper B-horizon soils at a depth interval of 30 to 40 inches below ground surface (BGS). A 1-hour presoak of all the test holes was performed prior to conducting the percolation tests. Percolation test results are included in Appendix 2.

Representative bulk soil samples were obtained from each test location at depths of approximately 32 to 36 inches BGS. Samples were analyzed for texture in SHN's certified soils testing laboratory in accordance with the methods prescribed by the North Coast Regional Water Quality Control Board (RWQCB). Laboratory test results are included in Appendix 3.

3.0 Site Conditions

The proposed primary disposal field and 100% replacement area will be located along the newly created eastern property line as shown in Figures 2 and 3. In the past, the area was primarily used for cattle grazing and feed production. The ground surface and shallow loamy soils are mostly undisturbed and retain their original soil morphology and structure. Ground slopes within the proposed disposal field area are nearly level with little to no discernible grade.



3.1 Soil

Field observation from the previous site investigations indicate soil horization to be relatively subtle, which we interpret to reflect the youthful age of the sediments. The surficial soils are characterized by a partially disturbed A-horizon composed of dark brown to dark grayish brown, organic-rich silt loam, sandy loam, and gravelly silt loam beginning at the ground surface and continuing to as deep as 1.5 to 2 feet BGS. Below 1.5 and 2 feet, soil texture varies slightly grading from soft, friable, and slightly plastic loam and clay loam to firm, non-plastic clay loam and sandy loam to loamy sand.

In general, the surficial loamy soils are characterized by single grain to weak subangular blocky structure, are friable and have slightly sticky to non-sticky, and non-plastic to slightly plastic wet consistencies. The soils observed at the lower horizons are characterized by weak subangular blocky structure, are friable to firm, with non-sticky to slightly sticky and non-plastic to slightly plastic wet consistencies.

The near-surface soils at the current project site are generally consistent in both texture and consistency as to those described above. A summary of laboratory test results from the current investigation is provided below.

3.2 Percolation Test Data

The stabilized percolation rates for the current site investigation are provided in Appendix 2 and are summarized in Table 1.

Table 1. Soil Percolation Rates

Test Hole No.	Depth (inches)	Soil Texture Suitability Chart	Stabilized Percolation Rate (minutes per inch)
PP-21	34-40	Loam	30
PP-22	30-36	Silt Loam	15
PP-23	32-38	Loam	9
PP-24	32-38	Silty Clay Loam	8

For design purposes, SHN recommends using the slowest percolation rate of 30 minutes per inch to size both the primary disposal field and 100% replacement area. On this basis, we recommend that the disposal system be designed using a soil application rate of 0.363 gpd per square foot (gpd/ft²) in accordance with application rates set forth in Table 3 (Pressure Distribution Soil Application Rates) of the Humboldt County OWTS Manual.

3.3 Laboratory Textural Analysis

Laboratory textural analysis work sheets prepared by SHN's materials testing laboratory for this current investigation are included in Appendix 3. Table 2 summarizes the laboratory textural analyses results of the bulk soil samples collected from the percolation test pits.



Table 2. Laboratory Soil Textural Analysis Results

Test Hole No.	Depth (inches)	Sand (percent)	Silt (percent)	Clay (percent)	Combined Fines (percent)	Coarse Fragments by Volume (percent)	Soil Suitability Percolation Chart
PP-21	36	33.7	41.5	24.8	66.3	0	Zone 3
PP-22	32	28.1	50.1	21.8	71.9	0	Zone 3
PP-23	32	26.8	46.8	26.4	73.2	0	Zone 3
PP-24	34	16.6	48.5	34.9	83.4	0	Zone 4
TP-25	32	43.5	37.9	18.6	56.5	0	Zone 2

As shown in Table 2, laboratory textural analyses conducted on samples collected from the soil B-horizon at the current project site indicate the presence of Zone 3 loam and silty loam to Zone 4 silty clay loam.

3.4 Groundwater

Depth-to-groundwater measurements for each of the neighboring sites are provided in the observation well data sheets included in Appendix 1. A total of 10 observation wells were installed between March 2018 and March 2019 and monitored during the respective wet-weather testing periods. Groundwater measurements collected during March 2019 from the wells located in the southwest corner of the subject parcel indicated groundwater depths ranging from 3.3 to about 4 feet BGS. Those collected during March and April 2018 from the adjoining parcel to the east (APN 507-181-007) indicated groundwater depths ranging from 6.7 to greater than 8 feet BGS.

Based on the ground surface elevations in the local vicinity, we interpret groundwater conditions at the current project site to be similar to those observed in the observation wells located approximately 300 feet to the east on the adjoining parcel (APN 507-181-007). The observation wells in the southwest corner of the subject parcel are located more than 900 feet from the currently proposed disposal field area and are about 2 feet lower in elevation. For design purposes, we have conservatively estimated a seasonally high groundwater elevation of 5 feet BGS.

4.0 Conclusions and Recommendations

Soil and groundwater conditions are suitable for the construction of a shallow, in-ground dispersal system to serve the proposed developments. The predominantly fine-grained nature of the soils, depth to seasonally-high groundwater, and the relatively large size of the proposed disposal field requires that a shallow, low-pressure pipe distribution system be used to ensure long-term reliability while minimizing the risk of system failure.

SHN recommends sizing the disposal field and 100% replacement area using a soil application rate equal to 0.363 gpd/ft² based on the field-measured percolation tests and in accordance with the application rate set forth in "Table 3: Pressure Distribution Soil Application Rates" of the Humboldt



County OWTS technical manual. The recommended depth, spacing, and orientation of the dispersal trenches are intended to promote subsoil aeration while maintaining an acceptable separation from the saturated zone. The configuration of the dispersal system is also intended to facilitate ease of construction without disturbing the near-surface soils adjacent to the trenches.

SHN recommends that a new, 12,000-gallon dual-compartment fiberglass wastewater storage tank and 4,000-gallon single-compartment concrete pump vault be installed in proximity to the location of where the waste line will exit the new facilities. It is recommended that both tanks be traffic rated to protect them from vehicular and truck traffic loads.

5.0 Disposal System Specifications

Calculations to determine the size and layout of the disposal system and pressurized distribution network are included in Appendix 4. A detailed site plan, storage tank and pump tank system details, dispersal system plan view, and trench cross-section view are included in Appendix 5, Sheets G-1, G-2, C-1, C-2, C-3, and C-4. Buoyancy calculations for the fiberglass septic tank provided by Xerxes Corporation are provided in Sheet C-5.

The new wastewater storage and dispersal system is designed to accommodate daily wastewater flows of 4,060 gpd to serve up to 116 full-time workers. The dispersal system will require to be pressurized due to its large size, and distance from the wastewater storage tank location. The overall dimensions and number of distribution laterals will require that the discharged effluent alternate between four separate distribution cells using an automatic distributing valve. The distributing valve is recommended to allow use of a smaller horsepower pump while dispersing the effluent over a greater land area. A summary of design specifications and dispersal system layout is as follows:

- Wastewater from the production facility will flow to a 12,000-gallon, dual-compartment fiberglass septic tank. Effluent will gravity-flow from the effluent compartment of the septic tank to a 4,000-gallon single-compartment concrete pump vault. Effluent from the pump vault will be delivered to the disposal field using a high-head submersible effluent pump and supply line constructed of 3-inch diameter high density polyethylene (HDPE). SHN recommends that the supply line be maintained at a minimum burial depth to protect the line during construction of the greenhouses. Placement and depth should be checked against the greenhouse design to prevent conflicts with the foundation.
- Effluent will be disposed of in the subsurface disposal field by alternating between four separate distribution cells using an automatic distributing valve that is actuated through a combination of pressure and flow.
- Each distribution cell is to consist of 8 pressurized distribution laterals constructed of 1¼-inch diameter Schedule 40 polyvinyl chloride (PVC) with lengths of 70 feet each. The end of each distribution lateral is required to have an upturned clean-out consisting of a PVC female adaptor with a threaded cap for ease of access and periodic cleaning.



- Each distribution lateral is to contain 1/8-inch orifices spaced 5-feet apart and pointed downward. The orifices are to begin and end 2.5-feet from the ends of each lateral. A total of 14 orifices are to be drilled in each lateral.
- The laterals in each distribution cell are to be connected to an end-feed manifold constructed of 1½-inch diameter Schedule 40 PVC that are supplied by the automatic distributing valve.
 - Trenches in each distribution cell are to be spaced 8 feet on center and excavated to a depth of 36 inches and width of 24 inches.
 - The 1¼-inch distribution laterals are to be constructed on top of 18 inches of washed pea gravel. An additional 6 inches of gravel shall be placed around and on top of the distribution laterals and covered with filter fabric. The remaining 12 inches of trench is to be filled with native loam soil that is mounded above the ground surface to account for future settlement.
- It will be important that only light excavation (low ground impact) equipment (such as, a rubber track-mounted mini-excavator) be used for the trench excavation and pea gravel placement within the disposal field area. Under no circumstances should the native grasses and soil between trenches be disturbed, removed, or compacted. Compromising the soil's natural ability to drain could lead to failure of the system.
- Construction and installation of the entire wastewater storage, pumping, and dispersal system should be performed by a qualified licensed contractor in accordance with the recommendations and specifications contained within this report.

Please call me at (707) 441-8855 if you have any questions or concerns.

Sincerely,

SHN



Giovanni A. Vadurro, CEG 2554
Engineering Geologist

GAV/CMT:lam

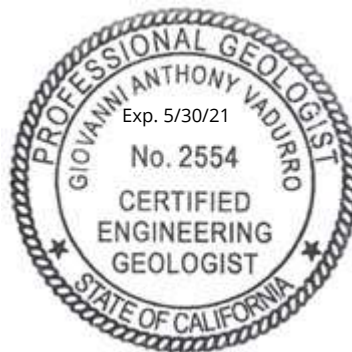

- Appendices:
1. Previous Site Assessment Data for APNs 506-231-011 and 507-181-007
 2. Percolation Test Data (Parcel D)
 3. Laboratory Textural Analysis Results (Parcel D)
 4. Pressure Distribution System Design Calculations and System Specifications (Parcel D)
 5. Civil Plan Sheets G-1, G-2, C-1, C-2, C-3, C-4, and C-5 (Parcel D)



References

Humboldt County Department of Health and Human Services Division of Environmental Health (November 7, 2017). "Humboldt County Onsite Wastewater Treatment System (OWTS) Regulations and Technical Manual." Eureka, CA: HCDEH.

Kelly-O'Hern Associates. (March 2020). "Plot Plan for Arcata Land Company LLC," Eureka, CA: Kelly-O'Hern.



**Previous Site Assessment
Data for APNs 506-231-011
and 507-181-007**

1

SITE ASSESSMENT DATA

APN 506-231-011 (March 2019)

Path: \\Eureka\Projects\2017\017062-Arcata\andCo\100-Leachfield\GIS\PROJ_MXD\APNS0623101\1\Figure1_ProjectLocationMap.mxd User Name: jsousa DATE: 6/7/19, 10:38AM

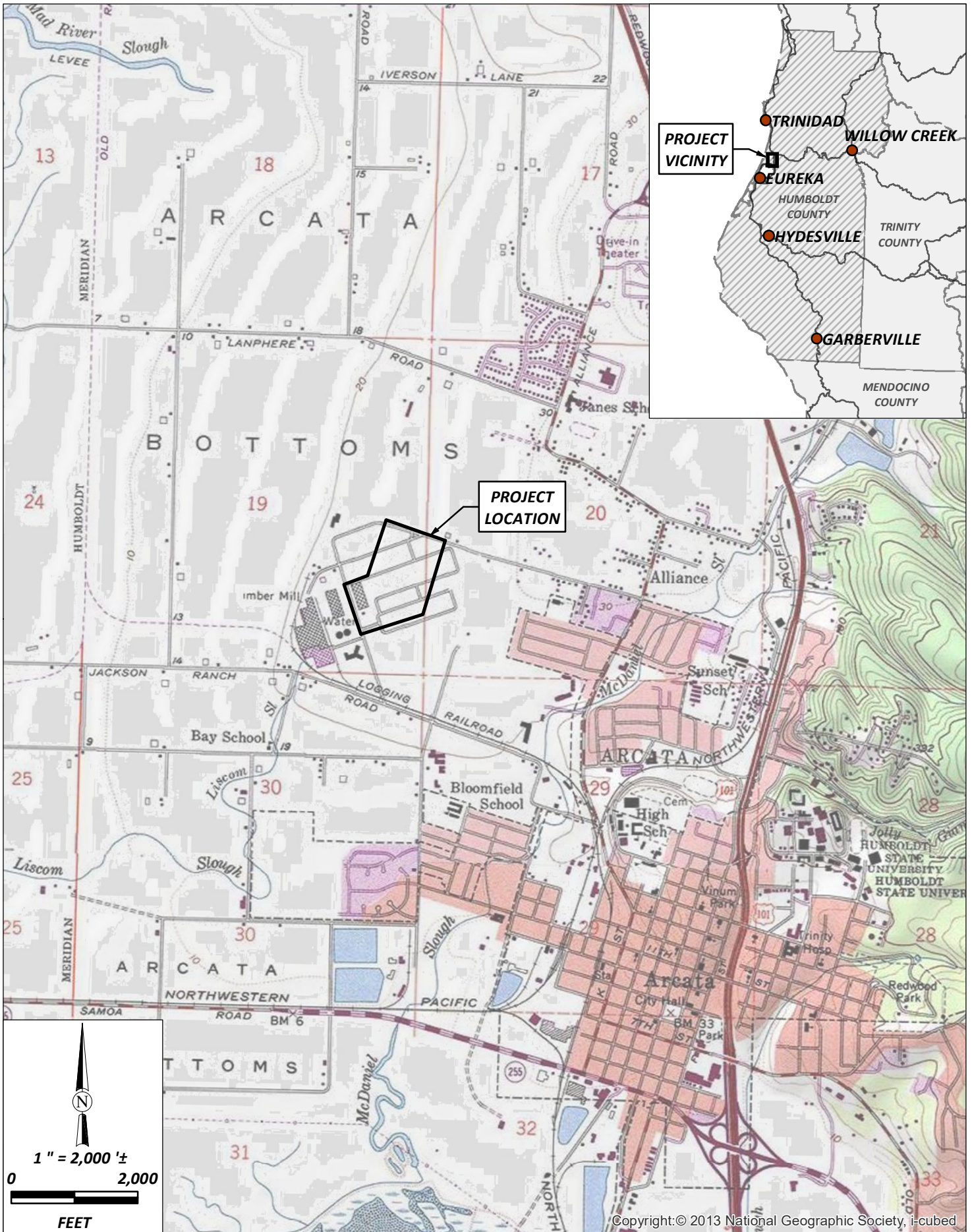

Copyright:© 2013 National Geographic Society, i-cubed



Arcata Land Co
 Onsite Septic Suitability Study
 Arcata, California

June 2019

Project Location Map
 APN: 506-231-011
 SHN 017062.100

Figure 1



Arcata Land Co
Onsite Septic Suitability Study
Arcata, California

June 2019

Site Map showing Test Locations
APN: 506-231-011
SHN 017062.130

Figure 1



SHW Consulting Engineers & Geologists, Inc.

812 West Wabash, Eureka, CA 95501 ph. (707) 441-8855 fax. (707) 441-8877

PROJECT NAME: Arcata Land Company

PROJECT NUMBER: 017062.100

LOCATION: Parcel D

DATE EXCAVATED: 3/15/19

APN: 506-231-011

TOTAL DEPTH OF HOLE: 5.0 Feet BGS

EXCAVATION METHOD: Hand Auger

SAMPLER TYPE: Bulk

LOGGED BY: A. Call

HOLE
NUMBER

OW-17

DEPTH (ft)	GROUNDWATER LEVEL	DATE	BULK SAMPLE	TUBE SAMPLE	FIELD CLASSIFICATION BASED ON U.S.D.A. CLASSIFICATION SYSTEM TEXTURE, STRUCTURE, CONSISTENCY, MOISTURE, COLOR, REMARKS	Laboratory Data				Perc Rate (MPI)	WATER MONITOR CONSTRUCTION	WATER MONITOR DETAILS	REMARKS
						Coarse Fragments % By Volume	% Fines	Bulk Density (g/cc)	Percolation Suitability Zone				

0					GRASS, ROOTS, upper 0.5 foot								
-1	X	3/15/19			SILT LOAM, dark brown, single grain to weak subangular blocky, soft, friable, damp, non-sticky, slightly plastic, very fine sand. Grades to:	4	39	2	16		2" Schedule 40 0.010 slot PVC Screen from 0 to 5 feet BGS.	Perc test performed at 0.5 to 1.5 feet BGS.	
-2	X	3/26/19			LOAM, dark grayish brown, weak subangular blocky, soft, very friable, damp, non-sticky, slightly plastic.	7	20	2					
-3	▲	3/21/19			SANDY LOAM, weakly mottled, dark brown and reddish brown, weak subangular blocky, soft, friable, damp, non-sticky, non-plastic. Becomes gravelly, wet.								
-4					LOAMY SAND WITH GRAVEL, brown, weak subangular blocky, soft, friable, wet, non-sticky, non-plastic. Gravels present in lenses Becomes saturated at 4 feet BGS. Caving and flowing sand at 4.5 feet BGS.							Free groundwater encountered at 3.8 feet BGS on 3/15/2019	
-5					Bottom of Hand Auger boring at 5 feet BGS. Refusal on caving/flowing sands.								
-6													
-7													
-8													
-9													
-10													
-11													
-12													

The log and data presented are a simplification of actual conditions encountered at the time of drilling at the drilled location. Subsurface conditions may differ at other locations and at the time of future drilling.



Consulting Engineers & Geologists, Inc.

812 West Wabash, Eureka, CA 95501 ph. (707) 441-8855 fax. (707) 441-8877

PROJECT NAME: Arcata Land Company

PROJECT NUMBER: 017062.100

LOCATION: Parcel D

DATE EXCAVATED: 3/15/19

APN: 506-231-011

TOTAL DEPTH OF HOLE: 6.0 Feet BGS

EXCAVATION METHOD: Hand Auger

SAMPLER TYPE: Bulk

LOGGED BY: A. Call

HOLE
NUMBER
OW-18

DEPTH (ft)	GROUNDWATER LEVEL	DATE	BULK SAMPLE TUBE SAMPLE	FIELD CLASSIFICATION BASED ON U.S.D.A. CLASSIFICATION SYSTEM TEXTURE, STRUCTURE, CONSISTENCY, MOISTURE, COLOR, REMARKS	Laboratory Data				Perc Rate (MPH)	WATER MONITOR CONSTRUCTION	WATER MONITOR DETAILS	REMARKS
					Coarse Fragments % By Volume	% Fines	Bulk Density (g/cc)	Percolation Suitability Zone				

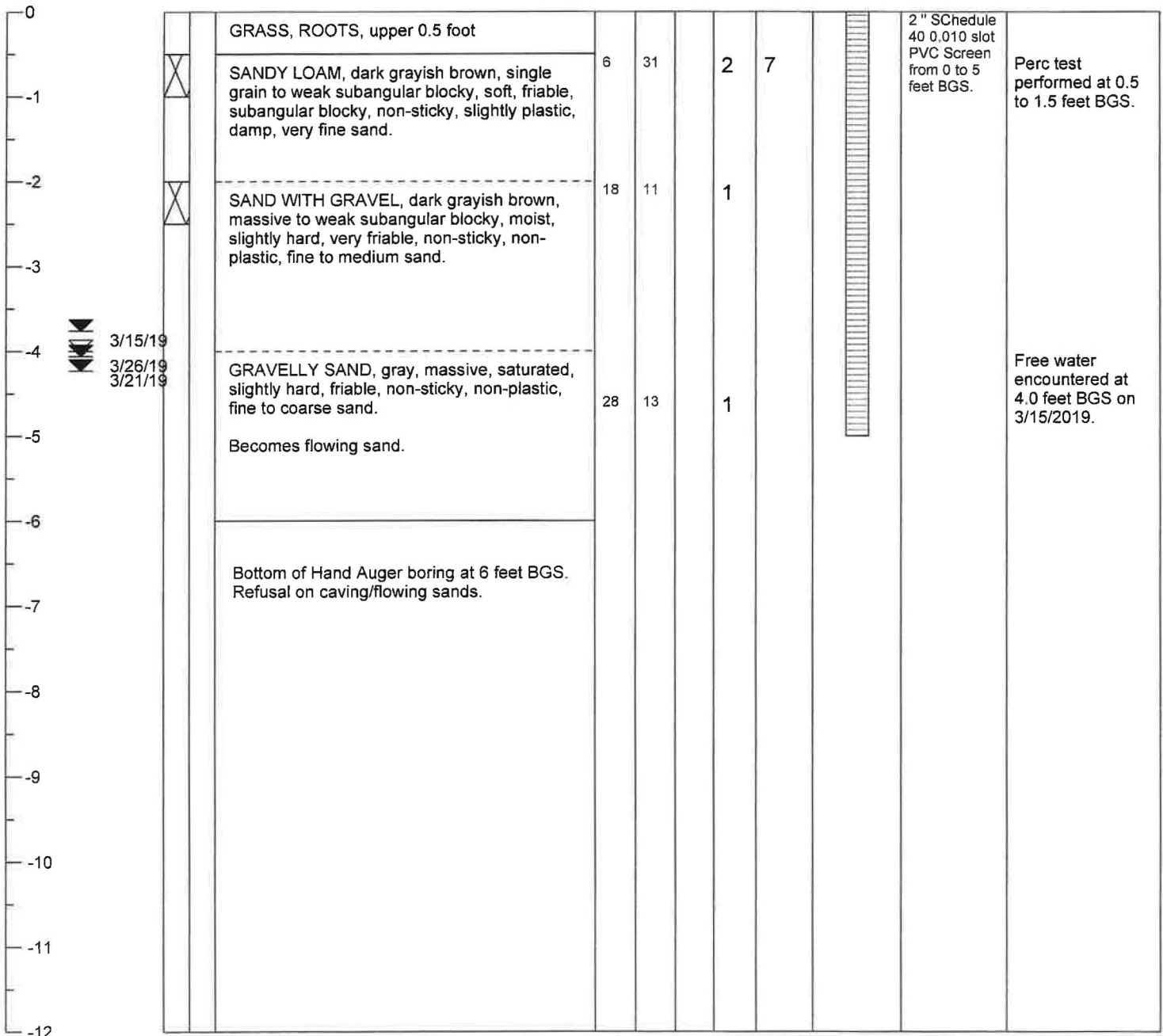

The log and data presented are a simplification of actual conditions encountered at the time of drilling at the drilled location. Subsurface conditions may differ at other locations.



Consulting Engineers & Geologists, Inc.

812 West Wabash, Eureka, CA 95501 ph. (707) 441-8855 fax. (707) 441-8877

PROJECT NAME: Arcata Land Company

PROJECT NUMBER: 017062.100

LOCATION: Parcel D

DATE EXCAVATED: 3/15/19

APN: 506-231-011

TOTAL DEPTH OF HOLE: 5.0 Feet BGS

EXCAVATION METHOD: Hand Auger

SAMPLER TYPE: Bulk

LOGGED BY: A. Call

**HOLE
NUMBER

OW-19**

DEPTH (ft)	GROUNDWATER LEVEL	DATE	BULK SAMPLE TUBE SAMPLE	FIELD CLASSIFICATION BASED ON U.S.D.A. CLASSIFICATION SYSTEM TEXTURE, STRUCTURE, CONSISTENCY, MOISTURE, COLOR, REMARKS	Laboratory Data				Perc Rate (MPL)	WATER MONITOR CONSTRUCTION	WATER MONITOR DETAILS	REMARKS
					Coarse Fragments % By Volume	% Fines	Bulk Density (g/cc)	Percolation Suitability Zone				

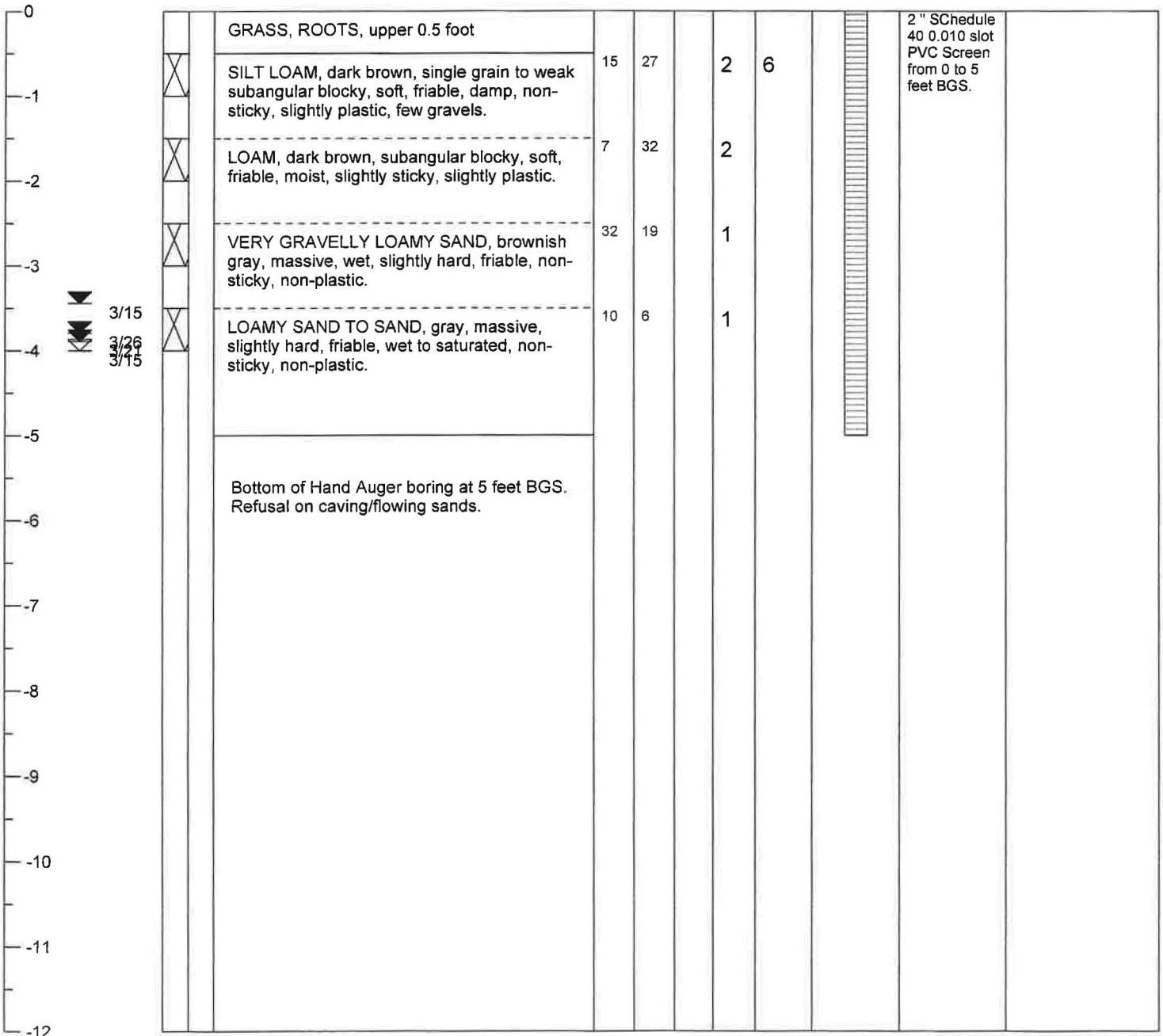



Consulting Engineers & Geologists, Inc.

812 West Wabash, Eureka, CA 95501 ph. (707) 441-8855 fax. (707) 441-8877

PROJECT NAME: Arcata Land Company
LOCATION: Parcel D
APN: 506-231-011
EXCAVATION METHOD: Hand Auger
LOGGED BY: A. Call

PROJECT NUMBER: 017062.100
DATE EXCAVATED: 3/15/19
TOTAL DEPTH OF HOLE: 5.0 Feet BGS
SAMPLER TYPE: Bulk

**HOLE
NUMBER
OW-20**

DEPTH (ft)	GROUNDWATER LEVEL	DATE	BULK SAMPLE TUBE SAMPLE	FIELD CLASSIFICATION BASED ON U.S.D.A. CLASSIFICATION SYSTEM TEXTURE, STRUCTURE, CONSISTENCY, MOISTURE, COLOR, REMARKS	Laboratory Data				Perc. Rate (MP)	WATER MONITOR CONSTRUCTION	WATER MONITOR DETAILS	REMARKS
					Coarse Fragments % By Volume	% Fines	Bulk Density (g/cc)	Percolation Suitability Zone				

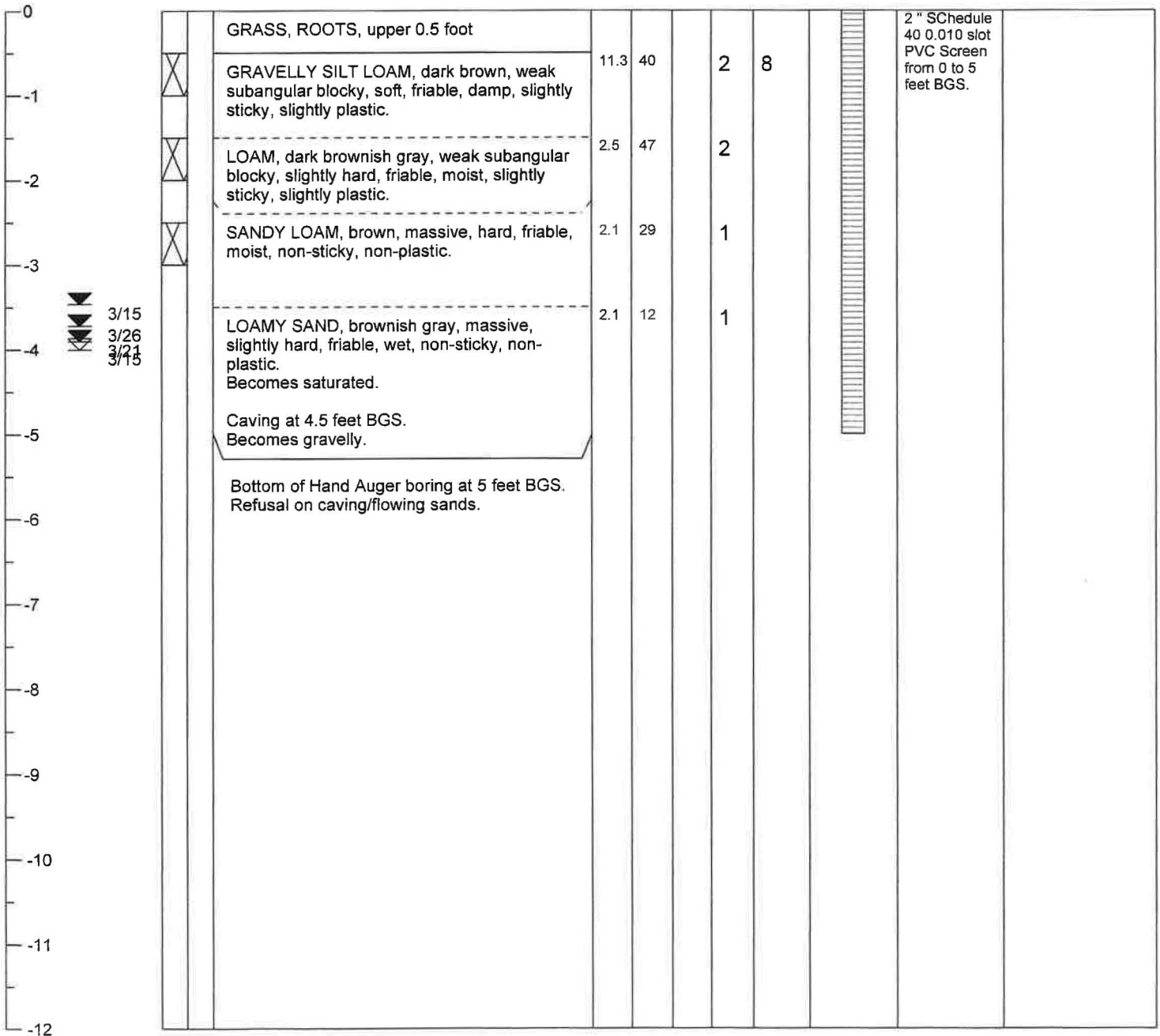

The log and data presented are a simplification of actual conditions encountered at the time of drilling at the drilled location. Subsurface conditions may differ at other locations.



Reference: 017062.100

April 3, 2019

Arcata Land Company, LLC
P.O. Box 997
Arcata, CA 95519

SOIL PERCOLATION SUITABILITY / TEXTURAL ANALYSIS RESULTS

Job Name: Arcata Land Company	Sampled By: AC
Date Sampled: 03/15/19	Date Tested: 04/03/19
Date Received: 03/26/19	AP Number: Not Provided

<u>Sample ID</u>	<u>Depth</u>	<u>% Sand</u>	<u>% Clay</u>	<u>% Silt</u>	<u>Volume</u>	<u>Zone</u>	<u>Bulk Density</u>
OW-17	1.0-1.5'	61.1	17.0	21.9	4.2	2	*
	Material:	Sandy Loam					
OW-17	2.0-2.5'	79.9	8.3	11.8	6.8	2	*
	Material:	Loamy Sand					
OW-18	0.5-1.0'	68.7	13.0	18.3	6.4	2	*
	Material:	Sandy Loam					
OW-18	2.0-2.5'	88.9	4.6	6.5	18.4	1	*
	Material:	Sand					
OW-18	4.5-5.0'	86.6	4.5	8.9	27.5	1	*
	Material:	Sand					

* = no peds provided

Regional Water Quality Control Board Zone Descriptions:

Zone 1 - Soils in this zone are very high in sand content. They readily accept effluent, but because of their low silt and clay content they provide minimal filtration. These soils demand greater separation distances from groundwater.

Zone 2 - Soils in this zone provide adequate percolation rates and filtration of effluent. They are suitable for use of a conventional system without further testing.

Zone 3 - Soils in this zone are expected to provide good filtration of effluent, but their ability to accept effluent at a suitable rate is questionable. These soils require wet-weather percolation tests to verify their suitability for effluent disposal by conventional leachfield methods.

Zone 4 - Soils in this zone are unsuitable for a conventional leachfield because of their severe limitations for accepting effluent.



Reference: 017062.100

April 3, 2019

Arcata Land Company, LLC
P.O. Box 997
Arcata, CA 95519

SOIL PERCOLATION SUITABILITY/ TEXTURAL ANALYSIS RESULTS

Job Name: Arcata Land Company Sampled By: AC
Date Sampled: 03/15/19 Date Tested: 04/03/19
Date Received: 03/26/19 AP Number: Not Provided

Sample ID	Depth	% Sand	% Clay	% Silt	% Coarse		Zone	Bulk Density
					Volume	Fragments by		
OW-19	0.5-1.0'	72.6	9.6	17.8	15.2		2	*
	Material:	Sandy Loam						
OW-19	1.5-2.0'	67.6	13.5	18.9	7.0		2	*
	Material:	Sandy Loam						
OW-19	2.5-3.0'	81.1	8.5	10.4	31.8		1	*
	Material:	Sand						
OW-19	3.5-4.0'	93.6	2.9	3.5	9.8		1	*
	Material:	Sand						

* = no peds provided

Regional Water Quality Control Board Zone Descriptions:

Zone 1 - Soils in this zone are very high in sand content. They readily accept effluent, but because of their low silt and clay content they provide minimal filtration. These soils demand greater separation distances from groundwater.

Zone 2 - Soils in this zone provide adequate percolation rates and filtration of effluent. They are suitable for use of a conventional system without further testing.

Zone 3 - Soils in this zone are expected to provide good filtration of effluent, but their ability to accept effluent at a suitable rate is questionable. These soils require wet-weather percolation tests to verify their suitability for effluent disposal by conventional leachfield methods.

Zone 4 - Soils in this zone are unsuitable for a conventional leachfield because of their severe limitations for accepting effluent.



Reference: 017062.100

April 3, 2019

Arcata Land Company
P.O. Box 997
Arcata, CA 95519

SOIL PERCOLATION SUITABILITY / TEXTURAL ANALYSIS RESULTS

Job Name: Arcata Land Company Sampled By: AC
Date Sampled: 03/15/19 Date Tested: 04/03/19
Date Received: 03/26/19 AP Number: Not Provided

<u>Sample ID</u>	<u>Depth</u>	<u>% Sand</u>	<u>% Clay</u>	<u>% Silt</u>	<u>% Coarse</u>		<u>Bulk Density</u>
					<u>Volume</u>	<u>Fragments by</u>	
OW-20	0.5-1.0'	60.2	15.6	24.2	11.3	2	*
	Material: Sandy Loam						
OW-20	1.5-2.0'	53.1	18.0	28.9	2.5	2	*
	Material: Sandy Loam						
OW-20	2.5-3.0'	71.5	11.9	16.6	2.1	2	*
	Material: Sandy Loam						
OW-20	3.5-4.0'	88.2	5.2	6.6	2.1	1	*
	Material: Sand						

* = no peds provided

Regional Water Quality Control Board Zone Descriptions:

Zone 1 - Soils in this zone are very high in sand content. They readily accept effluent, but because of their low silt and clay content they provide minimal filtration. These soils demand greater separation distances from groundwater.

Zone 2 - Soils in this zone provide adequate percolation rates and filtration of effluent. They are suitable for use of a conventional system without further testing.

Zone 3 - Soils in this zone are expected to provide good filtration of effluent, but their ability to accept effluent at a suitable rate is questionable. These soils require wet-weather percolation tests to verify their suitability for effluent disposal by conventional leachfield methods.

Zone 4 - Soils in this zone are unsuitable for a conventional leachfield because of their severe limitations for accepting effluent.

Observation Well Data

				Project #: 017062.100 Arcata Land Co.				APN: 506-231-011			
Observation Well ID				OW-17		OW-18		OW-19		OW-20	
Total well depth				5.09		5.04		5.09		5.09	
Height of top of casing above ground				0.4		0.25		0.67		0.65	
Well depth below ground surface				4.69		4.79		4.42		4.44	
DATE	PRECIPITATION		TIME								
(dd/mm/yr)	Daily	Total	(am/pm)	Reading	Depth bgs	Reading	Depth bgs	Reading	Depth bgs	Reading	Depth bgs
3/15/2019	0	34.27	1657	3.65	3.25	4.01	3.76	4.11	3.44	4.11	3.46
3/21/2019	0	34.4	1530	4.1	3.7	4.48	4.23	4.56	3.89	4.55	3.9
3/26/2019	1.15	35.81	1204	3.92	3.52	4.31	4.06	4.39	3.72	4.37	3.72

Reading = measured reading of groundwater relative to the top of well casing.

Depth = depth to groundwater below the ground surface.

ND = non-detection of groundwater (dry well).



SOILS PERCOLATION TEST DATA SHEET

CLIENT	<u>Arcata Land Co.</u>	DATE	<u>4/2/2019</u>
JOB REF.	<u>017062.100</u>	APN	<u>506-231-011</u>
TEST PIT No.	<u>OW-17</u>	TESTED BY	<u>AC</u>
DEPTH TESTED	<u>6"-18"</u>	DTW	<u>3.52'</u>
PRE-SOAK	<u>1 Hour</u>		

Reading No.	Start Time	Stop Time	Interval (Minutes)	Water Level Drop (Inches)	Percolation Rate (Minutes per Inch)
1	15:45	16:00	15	1 1/10	14
2	16:00	16:15	15	1 1/10	14
3	16:15	16:30	15	1 1/20	14
4	16:30	16:45	15	1 1/20	14
5	16:45	17:00	15	19/20	16
6	17:00	17:15	15	19/20	16

STABILIZED PERCOLATION RATE = 16

TEST PIT No.	<u>OW-18</u>	TESTED BY	<u>AC</u>
DEPTH TESTED	<u>6"-18"</u>	DTW	<u>3.76'</u>
PRE-SOAK	<u>1 Hour</u>		

Reading No.	Start Time	Stop Time	Interval (Minutes)	Water Level Drop (Inches)	Percolation Rate (Minutes per Inch)
1	15:48	16:03	15	2 1/4	7
2	16:03	16:18	15	2 3/10	7
3	16:18	16:33	15	2 1/4	7
4	16:33	16:48	15	2 1/4	7
5	16:48	17:03	15	2 1/5	7
6	17:03	17:18	15	2 1/5	7

STABILIZED PERCOLATION RATE = 7

TEST PIT No.	<u>OW-19</u>	TESTED BY	<u>AC</u>
DEPTH TESTED	<u>6"-18"</u>	DTW	<u>3.44'</u>
PRE-SOAK	<u>1 Hour</u>		

Reading No.	Start Time	Stop Time	Interval (Minutes)	Water Level Drop (Inches)	Percolation Rate (Minutes per Inch)
1	15:36	15:51	15	3 1/4	5
2	15:51	16:06	15	3 1/20	5
3	16:06	16:21	15	2 9/10	5
4	16:21	16:36	15	2 7/10	6
5	16:36	16:51	15	2 13/20	6
6	16:51	17:06	15	2 13/20	6

STABILIZED PERCOLATION RATE = 6

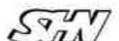

TEST PIT No. OW-20
 DEPTH TESTED 6"-18"
 PRE-SOAK 1 Hour

TESTED BY AC
 DTW 3.46'

Reading No.	Start Time	Stop Time	Interval (Minutes)	Water Level Drop (Inches)	Percolation Rate (Minutes per Inch)
1	15:39	15:54	15	2 1/10	7
2	15:54	16:09	15	2	8
3	16:09	16:24	15	1 9/10	8
4	16:24	16:39	15	1 4/5	8
5	16:39	16:54	15	1 9/10	8
6	16:54	17:09	15	1 4/5	8

STABILIZED PERCOLATION RATE = 8



SITE ASSESSMENT DATA

APN 507-181-007

(March/April 2018)

Path: \\eureka\projects\2017\017062-Arcata\landco\100-Leachfield\GIS\PROJ_1\MXD\Parcel4\Figure1_ProjectLocationMap.mxd User Name: psundberg

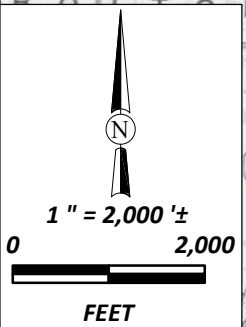
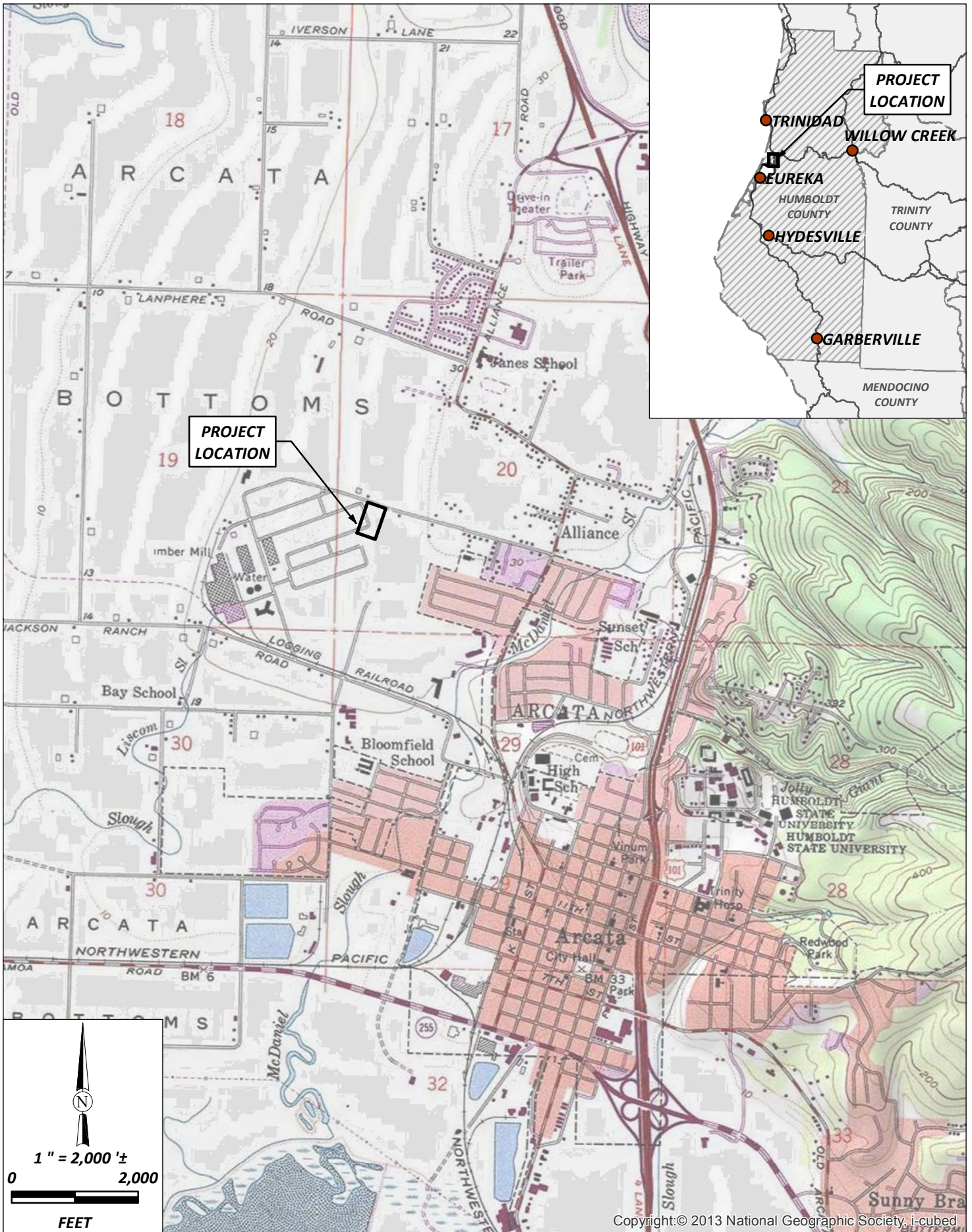

Copyright:© 2013 National Geographic Society, i-cubed

	Arcata Land Company Onsite Wastewater Treatment System Design Arcata, California		Project Location Map APN: 507-181-007 SHN 017062.100	
	July 2018	Figure1_ProjectLocationMap	Figure 1	

Path: \\eureka\projects\2017\017062-ArcataLandCo\100-Leachfield\GIS\PROJ_MXD\Parcel4\Figure2_SiteMap.mxd User Name: psundberg



EXPLANATION

- PERC PIT
- TEST PIT
- OBSERVATION WELLS

0 100
FEET

1" = 100'±

IMAGE SOURCE: GOOGLE EARTH, DATED 5/26/2016



Arcata Land Company
Onsite Wastewater Treatment System Design
Arcata, California

July 2018

Site Map Showing Test Locations
APN: 507-181-007
SHN 001283

Figure 2



Consulting Engineers & Geologists, Inc.

812 West Wabash, Eureka, CA 95501 ph. (707) 441-8855 fax. (707) 441-8877

PROJECT NAME: Onsite Wastewater Treatment System Design
LOCATION: Arcata, CA
APN: 507-181-007
EXCAVATION METHOD: Backhoe
LOGGED BY: PRS

PROJECT NUMBER: 017062.100
DATE EXCAVATED: 4/3/2018
TOTAL DEPTH OF HOLE: 8 Feet
SAMPLER TYPE: Bulk

**TEST PIT
NUMBER
TP-1**

DEPTH (ft)	BULK SAMPLE	TUBE SAMPLE	FIELD CLASSIFICATION BASED ON U.S.D.A. CLASSIFICATION SYSTEM TEXTURE, STRUCTURE, CONSISTENCY, MOISTURE, COLOR, REMARKS	Laboratory Data				Perc Rate (MP/1)	REMARKS
				Coarse Fragments % By Volume	% Fines	Bulk Density (g/cc)	Percolation Suitability Zone		

0			LOAM; Dark gray (10YR 4/1), friable, moist, moderate medium sub-angular blocky structure, sticky, slightly plastic, many fine roots.					
-1	X	X		30	68	3		
-2	X	X	CLAY LOAM; Dark grayish-brown (2.5Y 4/2), firm to very firm, moist, moderate coarse sub-angular blocky structure, slightly sticky, plastic.	23	79	3	15	% Sand = 32.3 % Silt = 38.9 % Clay = 28.8 % Sand = 21.3 % Silt = 46.9 % Clay = 31.8
-3								
-4			LOAM; Dark grayish-brown (2.5Y 4/2), very friable to friable, moist, weak medium sub-angular blocky structure, slightly sticky, non-plastic, fine sand, common medium distinct mottles.					
-5								
-6								
-7			SANDY LOAM; Grayish-brown, loose, moist, single-grain fine granular structure, non-sticky, non-plastic, approximately 25% fine to coarse sub-rounded gravel.					
-8			Excavation terminated at a depth of 8 feet. Groundwater not encountered. Test pit backfilled with excavated spoils.					
-9								
-10								

The log and data presented are a simplification of actual conditions encountered at the time of drilling at the drilled location. Subsurface conditions may differ at other locations.



Consulting Engineers & Geologists, Inc.

812 West Wabash, Eureka, CA 95501 ph. (707) 441-8855 fax. (707) 441-8877

PROJECT NAME: Onsite Wastewater Treatment System Design
LOCATION: Arcata, CA
APN: 507-181-007
EXCAVATION METHOD: Backhoe
LOGGED BY: PRS

PROJECT NUMBER: 017062.100
DATE EXCAVATED: 4/3/2018
TOTAL DEPTH OF HOLE: 8 Feet
SAMPLER TYPE: Bulk

**TEST PIT
 NUMBER
 TP-2**

DEPTH (ft)	BULK SAMPLE TUBE SAMPLE	FIELD CLASSIFICATION BASED ON U.S.D.A. CLASSIFICATION SYSTEM TEXTURE, STRUCTURE, CONSISTENCY, MOISTURE, COLOR, REMARKS	Laboratory Data				Perc Rate (MP1)	REMARKS
			Coarse Fragments % By Volume	% Fines	Bulk Density (g/cc)	Percolation Suitability Zone		

0		CLAY LOAM; Dark gray (10YR 4/1), friable, moist, moderate medium sub-angular blocky structure, sticky, slightly plastic, many fine roots.				
-1	X		37	68	3	
-2		CLAY LOAM; Dark grayish-brown (2.5Y 4/2), firm to very firm, moist, moderate coarse sub-angular blocky structure, slightly sticky, plastic.			3	% Sand = 32.4 % Silt = 34.0 % Clay = 33.6
-3						
-4						
-5		CLAY LOAM; Dark grayish-brown (2.5Y 4/2), firm, moist, moderate coarse sub-angular blocky structure, slightly sticky, plastic, common fine faint mottles.				
-6						
-7						
-8		Excavation terminated at a depth of 8 feet. Groundwater not encountered. Test pit backfilled with excavated spoils.				
-9						
-10						

The log and data presented are a simplification of actual conditions encountered at the time of drilling at the drilled location. Subsurface conditions may differ at other



Consulting Engineers & Geologists, Inc.

812 West Wabash, Eureka, CA 95501 ph. (707) 441-8855 fax. (707) 441-8877

PROJECT NAME: Onsite Wastewater Treatment System Design

PROJECT NUMBER: 017062.100

LOCATION: Arcata, CA

DATE EXCAVATED: 4/3/2018

APN: 507-181-007

TOTAL DEPTH OF HOLE: 8 Feet

EXCAVATION METHOD: Backhoe

SAMPLER TYPE: Bulk

LOGGED BY: PRS

TEST PIT
NUMBER
TP-3

DEPTH (ft)	BULK SAMPLE TUBE SAMPLE	FIELD CLASSIFICATION BASED ON U.S.D.A. CLASSIFICATION SYSTEM TEXTURE, STRUCTURE, CONSISTENCY, MOISTURE, COLOR, REMARKS	Laboratory Data				Perc Rate (MPI)	REMARKS
			Coarse Fragments % By Volume	% Fines	Bulk Density (g/cc)	Percolation Suitability Zone		

0	X	SILT LOAM; Very dark gray (10YR3/1), friable, moist, moderate coarse, sub-angular blocky structure, sticky, non-plastic, many fine roots.	37	83	3	3.75	% Sand = 17.0 % Silt = 55.3 % Clay = 27.7
-1	X	CLAY LOAM; Darky grayish-brown (2.5Y 4/2), firm, moist, moderate coarse sub-angular blocky structure, slightly sticky, slightly plastic.	25	83	3	3.75	% Sand = 17.1 % Silt = 52.0 % Clay = 30.9
-2	X	common coarse distinct mottles					
-3							
-4							
-5							
-6							
-7		SANDY LOAM; Dark brown, loose to very friable, moist, single-grain fine granular structure, non-sticky, non-plastic.					
-8		Excavation terminated at a depth of 8 feet. Groundwater not encountered. Test pit backfilled with excavated spoils.					
-9							
-10							

The log and data presented are a simplification of actual conditions encountered at the time of drilling at the drilled location. Subsurface conditions may differ at other locations.



Consulting Engineers & Geologists, Inc.

812 West Wabash, Eureka, CA 95501 ph. (707) 441-8855 fax. (707) 441-8877

PROJECT NAME: Onsite Wastewater Treatment System Design

PROJECT NUMBER: 017062.100

LOCATION: Arcata, CA

DATE EXCAVATED: 4/3/2018

APN: 507-181-007

TOTAL DEPTH OF HOLE: 8 Feet

EXCAVATION METHOD: Backhoe

SAMPLER TYPE: Bulk

LOGGED BY: PRS

**TEST PIT
NUMBER
TP-4**

DEPTH (ft)	BULK SAMPLE	TUBE SAMPLE	Laboratory Data				Perc Rate (MPI)	REMARKS
			Coarse Fragments % By Volume	% Fines	Bulk Density (g/cc)	Percolation Suitability Zone		
FIELD CLASSIFICATION BASED ON U.S.D.A. CLASSIFICATION SYSTEM TEXTURE, STRUCTURE, CONSISTENCY, MOISTURE, COLOR, REMARKS								

0							
-1	X	X	SILT LOAM; Dark gray (10YR 4/1), friable to firm, moist, moderate coarse sub-angular blocky structure, slightly sticky, plastic, common fine roots.	36	85	3	% Sand = 14.9 % Silt = 56.7 % Clay = 28.4
-2			LOAM; Dark grayish-brown (2.5Y 4/2), firm, moist, moderate coarse sub-angular blocky structure, slightly sticky, non-plastic.			3.75	
-3							
-4							
-5							
-6							
-7			LOAMY SAND; Dark grayish-brown, loose, single-grain fine granular structure, non-sticky, non-plastic.				
-8			Excavation terminated at a depth of 8 feet. Groundwater not encountered. Test pit backfilled with excavated spoils.				
-9							
-10							

The log and data presented are a simplification of actual conditions encountered at the time of drilling at the drilled location. Subsurface conditions may differ at other locations adjacent to the test pit location.



Consulting Engineers & Geologists, Inc.

812 West Wabash, Eureka, CA 95501 ph. (707) 441-8855 fax. (707) 441-8877

PROJECT NAME: Onsite Wastewater Treatment System Design

PROJECT NUMBER: 017062.100

LOCATION: Arcata, CA

DATE EXCAVATED: 4/3/2018

APN: 507-181-007

TOTAL DEPTH OF HOLE: 8 Feet

EXCAVATION METHOD: Backhoe

SAMPLER TYPE: Bulk

LOGGED BY: PRS

**TEST PIT
NUMBER
TP-5**

DEPTH (ft)	BULK SAMPLE	TUBE SAMPLE	FIELD CLASSIFICATION BASED ON U.S.D.A. CLASSIFICATION SYSTEM TEXTURE, STRUCTURE, CONSISTENCY, MOISTURE, COLOR, REMARKS	Laboratory Data				Perc Rate (MP)	REMARKS
				Coarse Fragments % By Volume	% Fines	Bulk Density (g/cc)	Percolation Suitability Zone		

0			LOAM; Very dark gray (10YR 3/1), very friable, moist, moderate coarse sub-angular blocky structure, slightly sticky, non-plastic, many fine roots.	22	77	3		
-1	X	X						% Sand = 22.8 % Silt = 52.7 % Clay = 24.5
-2	X	X	CLAY LOAM; Dark grayish-brown (2.5Y 4/2), friable, moderate coarse sub-angular blocky structure, slightly sticky, slightly plastic.	20	80	3	2.73	% Sand = 19.9 % Silt = 49.5 % Clay = 30.6
-3								
-4								
-5								
-6								
-7			SANDY LOAM; Dark brown, loose to very friable, single-grain fine granular structure, non-sticky, non-plastic.					
-8			Excavation terminated at a depth of 8 feet. Groundwater not encountered. Test pit backfilled with excavated spoils.					
-9								
-10								

The log and data presented are a simplification of actual conditions encountered at the time of drilling at the drilled location. Subsurface conditions may differ at other locations.



Consulting Engineers & Geologists, Inc.

812 West Wabash, Eureka, CA 95501 ph. (707) 441-8855 fax. (707) 441-8877

PROJECT NAME: Onsite Wastewater Treatment System Design

PROJECT NUMBER: 017062.100

LOCATION: Arcata, CA

DATE EXCAVATED: 4/3/2018

APN: 507-181-007

TOTAL DEPTH OF HOLE: 8 Feet

EXCAVATION METHOD: Backhoe

SAMPLER TYPE: Bulk

LOGGED BY: PRS

**TEST PIT
NUMBER
TP-6**

DEPTH (ft)	BULK SAMPLE TUBE SAMPLE	FIELD CLASSIFICATION BASED ON U.S.D.A. CLASSIFICATION SYSTEM TEXTURE, STRUCTURE, CONSISTENCY, MOISTURE, COLOR, REMARKS	Laboratory Data				Perc Rate (MP)	REMARKS
			Coarse Fragments % By Volume	% Fines	Bulk Density (g/cc)	Percolation Suitability Zone		

0		LOAM; Very dark gray (10YR 3/1), friable, moist, moderate coarse sub-angular blocky structure, slightly sticky, slightly plastic, many fine roots.	15	74		3		% Sand = 26.4 % Silt = 47.2 % Clay = 26.4
-1	X X	LOAM; Dark grayish-brown (2.5Y 4/2), friable to firm, moist, moderate coarse sub-angular blocky structure, slightly sticky, plastic.					5	
-2		SANDY LOAM; Dark grayish-brown, very friable, weak medium sub-angular blocky structure, slightly sticky, non-plastic, common fine faint mottles.						
-3		Excavation terminated at a depth of 8 feet. Groundwater not encountered. Test pit backfilled with excavated spoils.						
-4								
-5								
-6								
-7								
-8								
-9								
-10								

The log and data presented are a simplification of actual conditions encountered at the time of drilling at the drilled location. Subsurface conditions may differ at other locations.



Consulting Engineers & Geologists, Inc.

812 West Wabash, Eureka, CA 95501 ph. (707) 441-8855 fax. (707) 441-8877

PROJECT NAME: Onsite Wastewater Treatment System Design

PROJECT NUMBER: 017062.100

LOCATION: Arcata, CA

DATE EXCAVATED: 3/27/2018

APN: 507-181-007

TOTAL DEPTH OF HOLE: 7.9 Feet

EXCAVATION METHOD: Hand Auger

SAMPLER TYPE: Bulk

LOGGED BY: PRS

**HOLE
NUMBER
OW-1**

DEPTH (ft)	GROUNDWATER LEVEL	DATE	BULK SAMPLE	FIELD CLASSIFICATION BASED ON U.S.D.A. CLASSIFICATION SYSTEM <small>TEXTURE, STRUCTURE, CONSISTENCY, MOISTURE, COLOR, REMARKS</small>	WATER MONITOR CONSTRUCTION	WATER MONITOR DETAILS	REMARKS
------------	-------------------	------	-------------	--	----------------------------	-----------------------	---------

0				SILT LOAM; Dark brown, moist, firm, slightly sticky, slightly plastic, many fine roots.		1-1/2" solid PVC 0 to 2.9' BGS with bentonite seal from 0 to 1' BGS.	
-1			X X	LOAM; Brown, friable to firm, moist, slightly sticky, slightly plastic, fine sand.			
-2				medium faint mottles			
-3				many medium distinct mottles, increase in fine sand			
-4				SANDY LOAM; Dark brown, friable, moist, non-sticky, non-plastic, fine sand.			
-5				LOAMY SAND; Dark brown, very friable, wet, non-sticky, non-plastic, medium sand, fine sub-rounded gravel.			
-6							
-7							
-8				Boring terminated at a depth of 7.9 feet. Groundwater not encountered. Backfilled with monterey sand and capped with bentonite.			
-9							
-10							

The log and data presented are a simplification of actual conditions encountered at the time of drilling at the drilled location. Subsurface conditions may differ at other locations and with the passage of time.



Consulting Engineers & Geologists, Inc.

812 West Wabash, Eureka, CA 95501 ph. (707) 441-8855 fax. (707) 441-8877

PROJECT NAME: Onsite Wastewater Treatment System Design

PROJECT NUMBER: 017062.100

LOCATION: Arcata, CA

DATE EXCAVATED: 3/27/2018

APN: 507-181-007

TOTAL DEPTH OF HOLE: 8.4 Feet

EXCAVATION METHOD: Hand Auger

SAMPLER TYPE: Bulk

LOGGED BY: ESP

**HOLE
NUMBER
OW-2**

DEPTH (ft)	GROUNDWATER LEVEL	DATE	BULK SAMPLE	FIELD CLASSIFICATION BASED ON U.S.D.A. CLASSIFICATION SYSTEM <small>TEXTURE, STRUCTURE, CONSISTENCY, MOISTURE, COLOR, REMARKS</small>	WATER MONITOR CONSTRUCTION	WATER MONITOR DETAILS	REMARKS
------------	-------------------	------	-------------	---	-------------------------------	--------------------------	---------

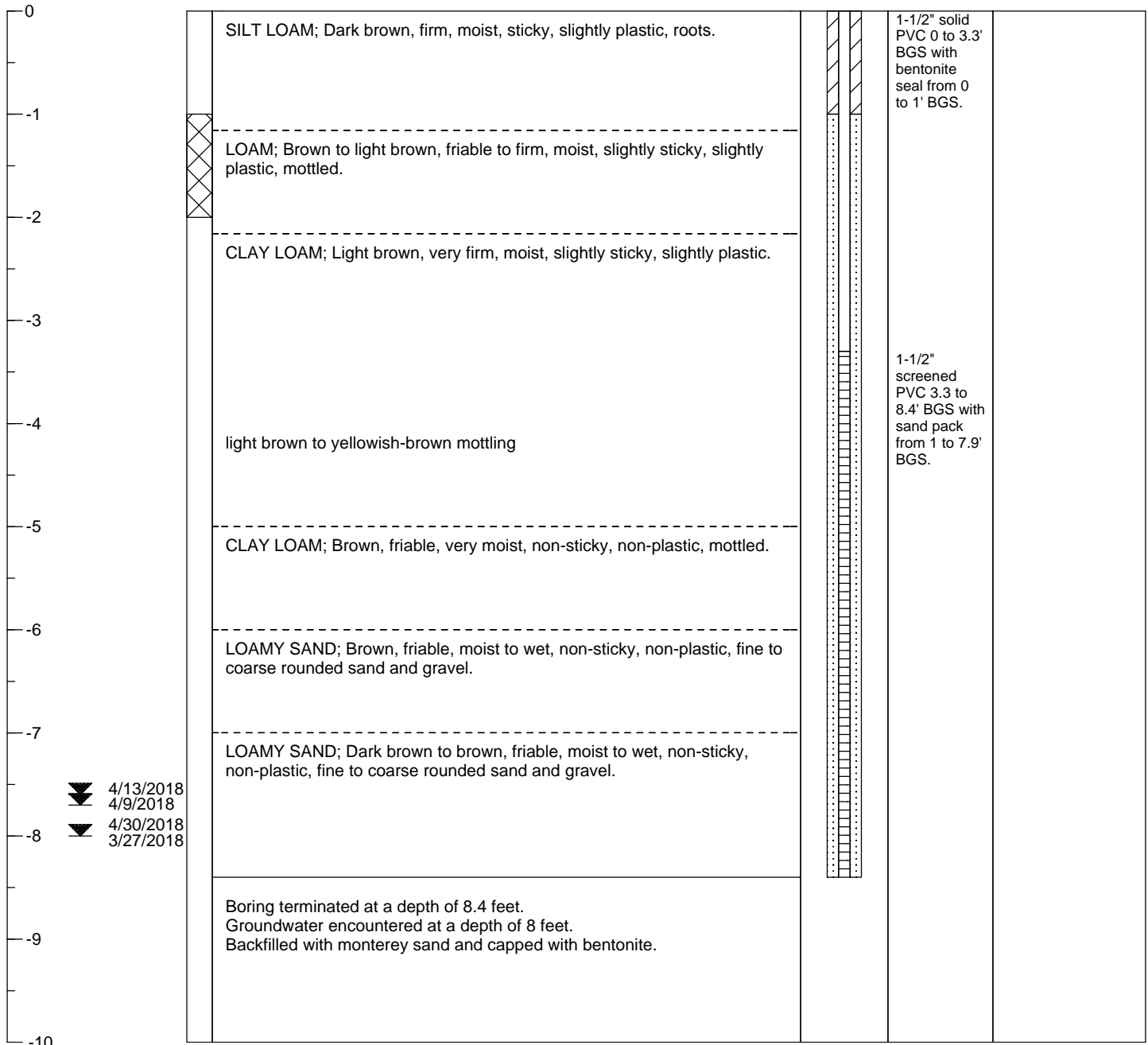

The log and data presented are a simplification of actual conditions encountered at the time of drilling at the drilled location. Subsurface conditions may differ at other locations and with the passage of time.



Consulting Engineers & Geologists, Inc.

812 West Wabash, Eureka, CA 95501 ph. (707) 441-8855 fax. (707) 441-8877

PROJECT NAME: Onsite Wastewater Treatment System Design

PROJECT NUMBER: 017062.100

LOCATION: Arcata, CA

DATE EXCAVATED: 3/27/2018

APN: 507-181-007

TOTAL DEPTH OF HOLE: 7.95 Feet

EXCAVATION METHOD: Hand Auger

SAMPLER TYPE: Bulk

LOGGED BY: PRS

**HOLE
NUMBER
OW-3**

DEPTH (ft)	GROUNDWATER LEVEL	DATE	BULK SAMPLE	FIELD CLASSIFICATION BASED ON U.S.D.A. CLASSIFICATION SYSTEM TEXTURE, STRUCTURE, CONSISTENCY, MOISTURE, COLOR, REMARKS	WATER MONITOR CONSTRUCTION	WATER MONITOR DETAILS	REMARKS
------------	-------------------	------	-------------	---	----------------------------	-----------------------	---------

0				SILT LOAM; Dark brown, firm, moist, slightly stick, slightly plastic, many fine roots.		1-1/2" solid PVC 0 to 2.95' BGS with bentonite seal from 0 to 1' BGS.	
-1			X X X X	CLAY LOAM; Brown, friable to firm, moist, common medium faint mottles, slightly sticky, slightly plastic, fine sand.			
-2				decrease in mottling			
-3							
-4						1-1/2" screened PVC 2.95 to 7.95' BGS with sand pack from 1 to 7.95' BGS.	
-5				SANDY LOAM; Brown, friable to firm, moist to wet, slightly sticky, slightly plastic, common coarse faint mottles.			
-6				decrease in fines			
-7				becomes wet			
-8							
-9				Boring terminated at a depth of 7.95 feet. Groundwater not encountered. Backfilled with monterey sand and capped with bentonite chips.			
-10							

The log and data presented are a simplification of actual conditions encountered at the time of drilling at the drilled location. Subsurface conditions may differ at other locations and with the passage of time.



Consulting Engineers & Geologists, Inc.

812 West Wabash, Eureka, CA 95501 ph. (707) 441-8855 fax. (707) 441-8877

PROJECT NAME: Onsite Wastewater Treatment System Design

PROJECT NUMBER: 017062.100

LOCATION: Arcata, CA

DATE EXCAVATED: 3/27/2018

APN: 507-181-007

TOTAL DEPTH OF HOLE: 8.25 Feet

EXCAVATION METHOD: Hand Auger

SAMPLER TYPE: Bulk

LOGGED BY: ESP

**HOLE
NUMBER
OW-4**

DEPTH (ft)	GROUNDWATER LEVEL	DATE	BULK SAMPLE	FIELD CLASSIFICATION BASED ON U.S.D.A. CLASSIFICATION SYSTEM <small>TEXTURE, STRUCTURE, CONSISTENCY, MOISTURE, COLOR, REMARKS</small>	WATER MONITOR CONSTRUCTION	WATER MONITOR DETAILS	REMARKS
------------	-------------------	------	-------------	---	-------------------------------	--------------------------	---------

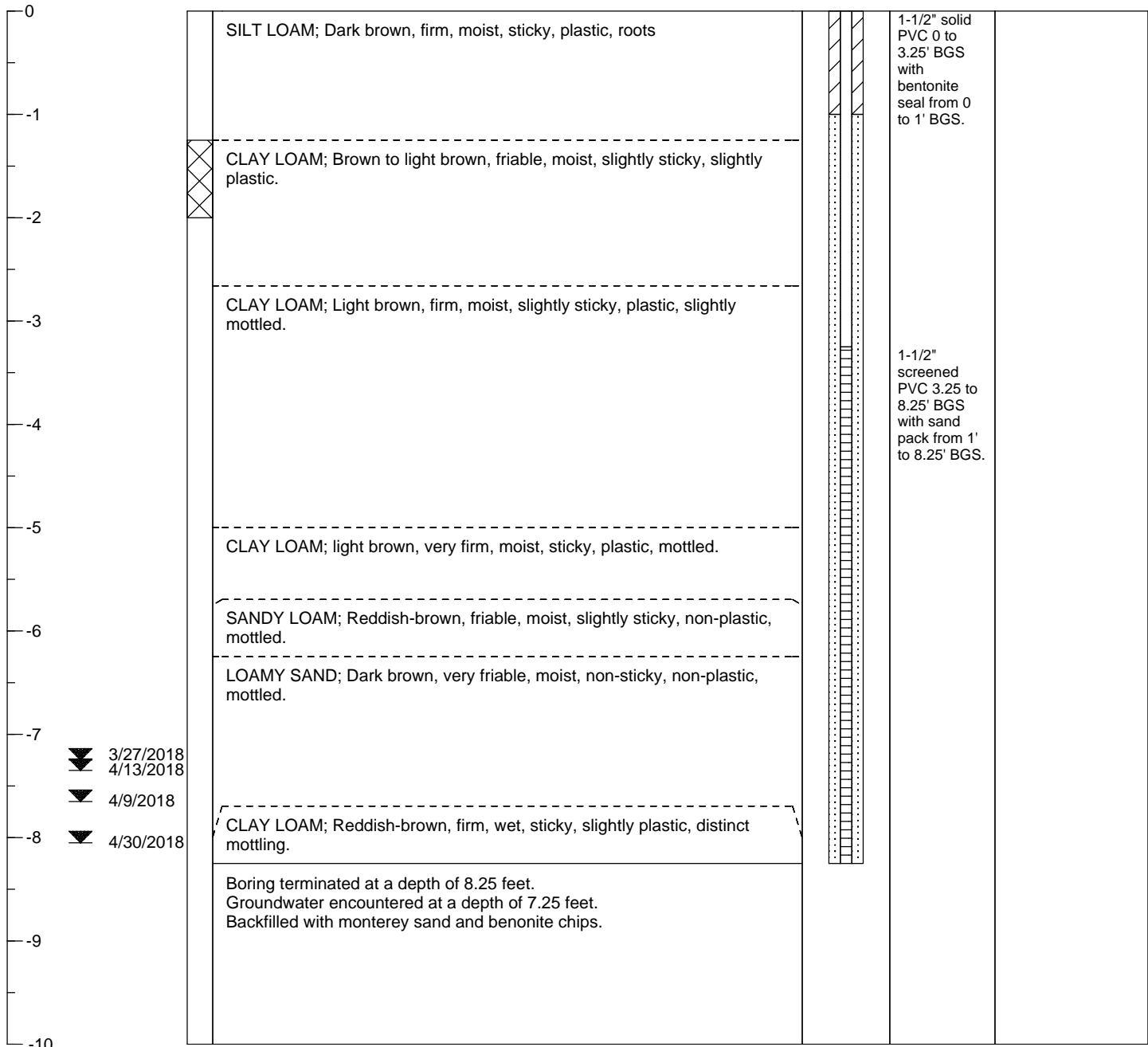

The log and data presented are a simplification of actual conditions encountered at the time of drilling at the drilled location. Subsurface conditions may differ at other locations and with the passage of time.



Consulting Engineers & Geologists, Inc.

812 West Wabash, Eureka, CA 95501 ph. (707) 441-8855 fax. (707) 441-8877

PROJECT NAME: Onsite Wastewater Treatment System Design

PROJECT NUMBER: 017062.100

LOCATION: Arcata, CA

DATE EXCAVATED: 3/27/2018

APN: 507-181-007

TOTAL DEPTH OF HOLE: 7.85 Feet

EXCAVATION METHOD: Hand Auger

SAMPLER TYPE: Bulk

LOGGED BY: ESP

**HOLE
NUMBER
OW-5**

DEPTH (ft)	GROUNDWATER LEVEL	DATE	BULK SAMPLE	FIELD CLASSIFICATION BASED ON U.S.D.A. CLASSIFICATION SYSTEM <small>TEXTURE, STRUCTURE, CONSISTENCY, MOISTURE, COLOR, REMARKS</small>	WATER MONITOR CONSTRUCTION	WATER MONITOR DETAILS	REMARKS
------------	-------------------	------	-------------	---	-------------------------------	--------------------------	---------

0				SILT LOAM; Dark brown, firm, moist, slightly sticky, slightly plastic, fine roots.		1-1/2" solid PVC 0 to 2.85' BGS with bentonite seal from 0 to 1' BGS.	
-1				CLAY LOAM; Brown, firm, moist, slightly sticky, slightly plastic.			
-2				becomes moist to wet; increase in fine sand; becomes friable			
-3							
-4				few faint mottles		1-1/2" screened PVC 2.85' to 7.85' BGS with sand pack from 1' to 7.85' BGS.	
-5							
-6				SANDY LOAM; Brown, friable, wet, sticky, non-plastic, many fine prominent mottles.			
-7				decrease in fines			
-8	▼	4/9/2018 4/13/2018 4/30/2018		Boring terminated at a depth of 7.85 feet. Groundwater not encountered. Backfilled with monterey sand and capped with bentonite chips.			Groundwater levels were observed at the same depth during each measurement
-9							
-10							

The log and data presented are a simplification of actual conditions encountered at the time of drilling at the drilled location. Subsurface conditions may differ at other locations and with the passage of time.



Consulting Engineers & Geologists, Inc.

812 West Wabash, Eureka, CA 95501 ph. (707) 441-8855 fax. (707) 441-8877

PROJECT NAME: Onsite Wastewater Treatment System Design

PROJECT NUMBER: 017062.100

LOCATION: Arcata, CA

DATE EXCAVATED: 3/27/2018

APN: 507-181-007

TOTAL DEPTH OF HOLE: 8.15 Feet

EXCAVATION METHOD: Hand Auger

SAMPLER TYPE: Bulk

LOGGED BY: ESP

**HOLE
NUMBER
OW-6**

DEPTH (ft)	GROUNDWATER LEVEL	DATE	BULK SAMPLE	FIELD CLASSIFICATION BASED ON U.S.D.A. CLASSIFICATION SYSTEM <small>TEXTURE, STRUCTURE, CONSISTENCY, MOISTURE, COLOR, REMARKS</small>	WATER MONITOR CONSTRUCTION	WATER MONITOR DETAILS	REMARKS
------------	-------------------	------	-------------	--	----------------------------	-----------------------	---------

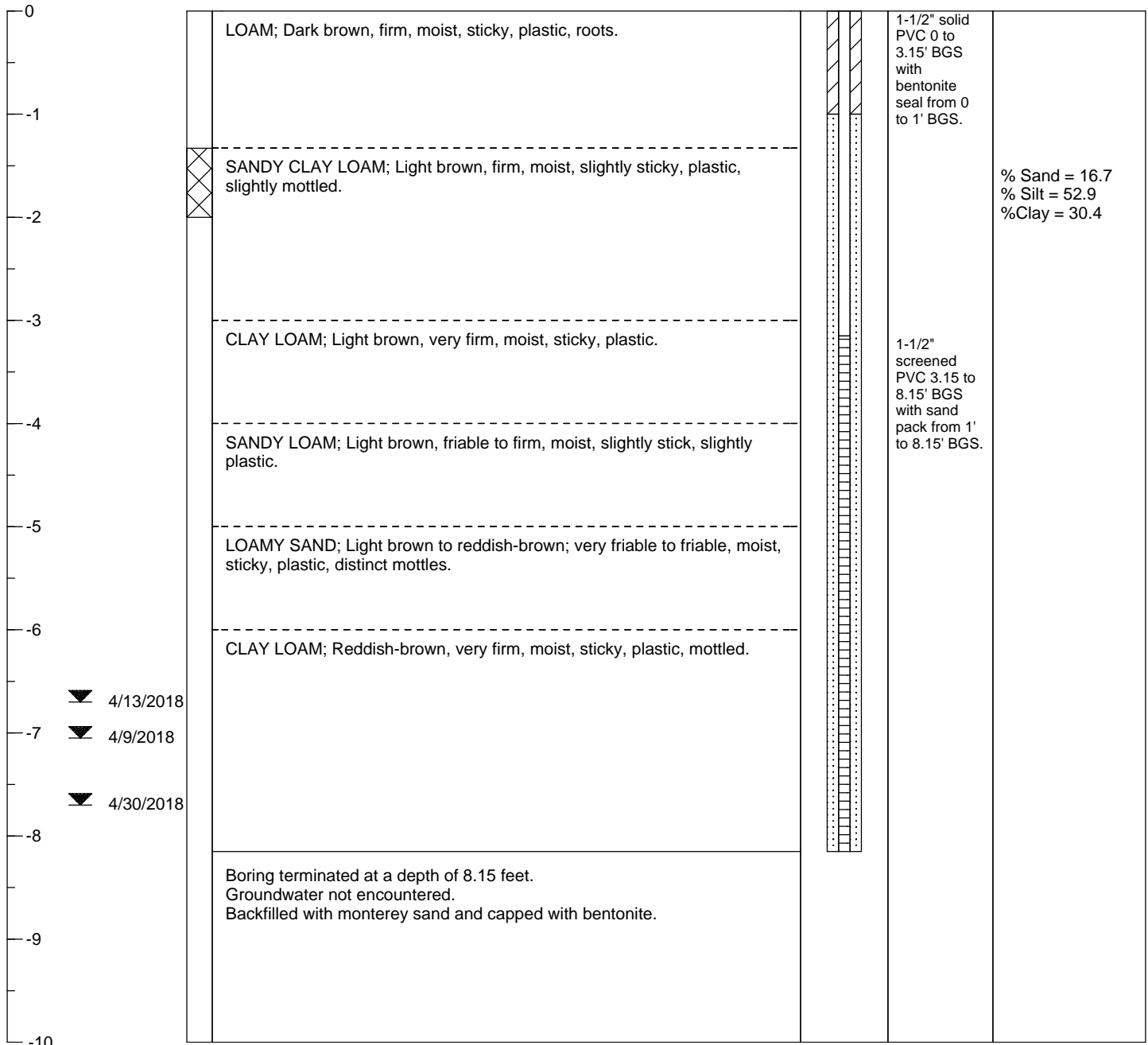

The log and data presented are a simplification of actual conditions encountered at the time of drilling at the drilled location. Subsurface conditions may differ at other locations and with the passage of time.



Reference: 017062.100

May 2, 2018

Arcata Land Company
P.O. Box 997
Arcata, CA 95519

SOIL PERCOLATION SUITABILITY / TEXTURAL ANALYSIS RESULTS

Job Name: Arcata Land Company Sampled By: PRS
Date Sampled: 04/03/18 Date Tested: 05/02/18
Date Received: 04/03/18 AP Number: 507-181-007

Sample ID	Depth	% Sand	% Clay	% Silt	% Coarse Fragments by		Zone	Bulk Density
					Volume			
TP-1	1-1.5'	32.3	28.8	38.9	30.1		3	*
		Material: Loam						
TP-1	1.5-2.0'	21.3	31.8	46.9	22.8		3	*
		Material: Clay Loam						
TP-2	1-1.5'	32.4	33.6	34.0	37.0		3	*
		Material: Clay Loam						
TP-3	0.5-1'	17.0	27.7	55.3	36.7		3	*
		Material: Silt Loam						
TP-3	1.5-2.0'	17.1	30.9	52.0	25.3		3	*
		Material: Clay Loam						

* = no peds provided

Regional Water Quality Control Board Zone Descriptions:

Zone 1 - Soils in this zone are very high in sand content. They readily accept effluent, but because of their low silt and clay content they provide minimal filtration. These soils demand greater separation distances from groundwater.

Zone 2 - Soils in this zone provide adequate percolation rates and filtration of effluent. They are suitable for use of a conventional system without further testing.

Zone 3 - Soils in this zone are expected to provide good filtration of effluent, but their ability to accept effluent at a suitable rate is questionable. These soils require wet-weather percolation tests to verify their suitability for effluent disposal by conventional leachfield methods.

Zone 4 - Soils in this zone are unsuitable for a conventional leachfield because of their severe limitations for accepting effluent.

SOIL PERCOLATION SUITABILITY CHART

LEGEND		
HOLE	DEPTH	SYMBOL
TP-1	1-1.5'	■
TP-1	1.5-2.0'	●
TP-2	1-1.5'	▲
TP-3	0.5-1'	◆
TP-3	1.5-2.0'	✱

Zone 1 = Coarse
Zone 2 = Acceptable
Zone 3 = Marginal
Zone 4 = Unacceptable

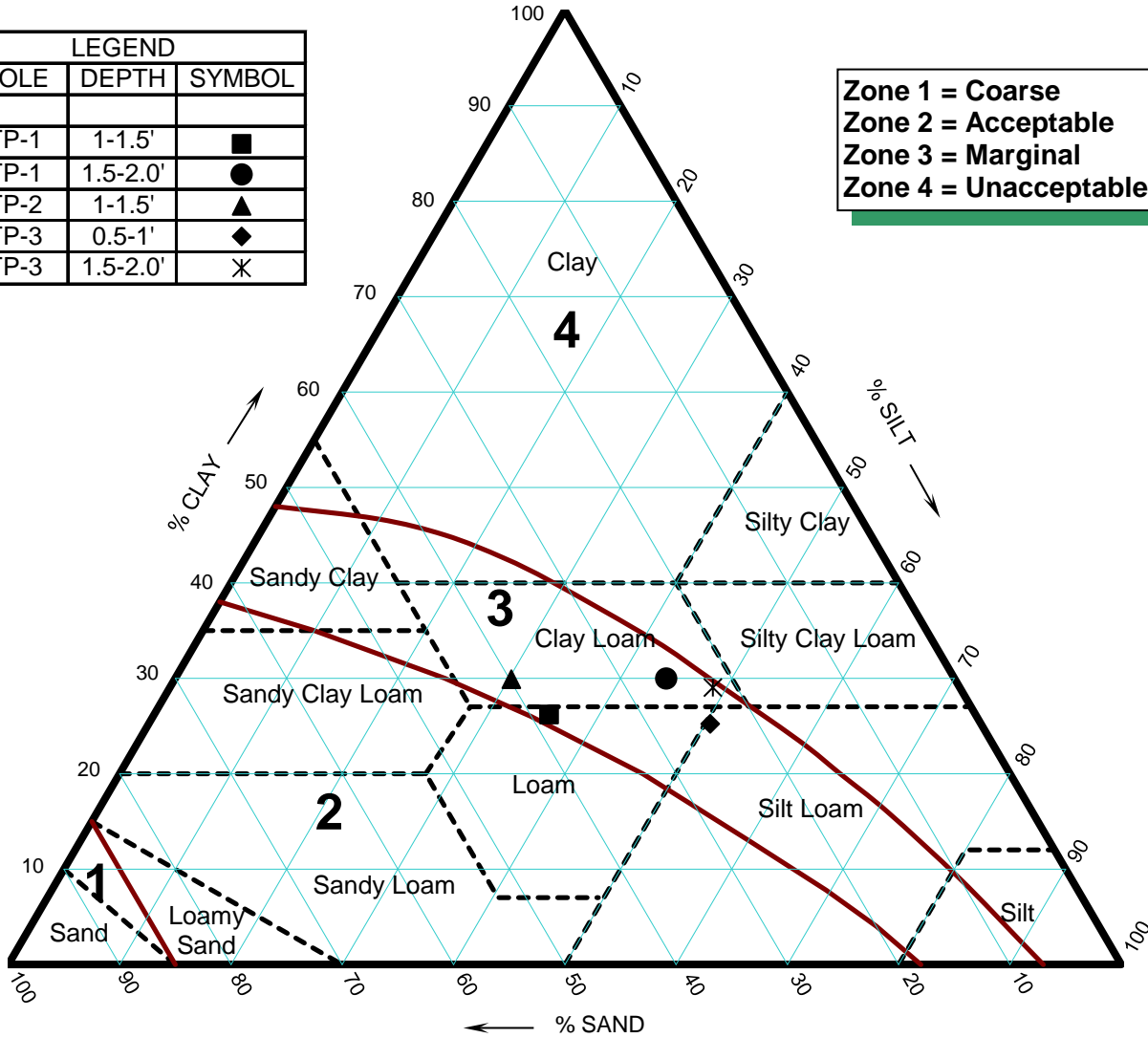

NOTES

1. Soil texture is plotted on triangle based on percent sand, silt, and clay as determined by hydrometer analysis.
2. Adjustment for coarse fragments has been made by moving the plotted point in the sand direction an additional 2% for each 10% (by volume) of fragments greater than 2mm in diameter.
3. Adjustment for compactness of soil has been made by moving the plotted point in the clay direction an additional 15% for soils having a bulk-density greater than 1.7 gm/cc, when analyzed.
4. For soils falling in sand, loamy sand, or sandy loam, classification adjustment for bulk density will generally not affect suitability and a bulk-density analysis was not necessary.

JOB NUMBER: 017062.100

DATE: 05/02/18

JOB NAME: Arcata Land Company

APN: 507-181-007



812 W. Wabash
 Eureka, CA 95501-2138
 (707) 441-8855



Reference: 017062.100

May 2, 2018

Arcata Land Company
P.O. Box 997
Arcata, CA 95519

SOIL PERCOLATION SUITABILITY / TEXTURAL ANALYSIS RESULTS

Job Name: Arcata Land Company Sampled By: PRS
Date Sampled: 04/03/18 Date Tested: 05/02/18
Date Received: 04/03/18 AP Number: 507-181-007

Sample ID	Depth	% Sand	% Clay	% Silt	% Coarse Fragments by		Zone	Bulk Density
					Volume			
TP-4	0.5-1'	14.9	28.4	56.7	36.0		3	*
		Material: Silt Loam						
TP-5	0.5-1'	22.8	24.5	52.7	22.1		3	*
		Material: Loam						
TP-5	1.5-2'	19.9	30.6	49.5	20.3		3	*
		Material: Clay Loam						
TP-6	0.5-1'	26.4	26.4	47.2	15.2		3	*
		Material: Loam						
OW-6	1-2'	16.7	30.4	52.9	0.0		4	*
		Material: Silty Clay Loam						

* = no peds provided

Regional Water Quality Control Board Zone Descriptions:

Zone 1 - Soils in this zone are very high in sand content. They readily accept effluent, but because of their low silt and clay content they provide minimal filtration. These soils demand greater separation distances from groundwater.

Zone 2 - Soils in this zone provide adequate percolation rates and filtration of effluent. They are suitable for use of a conventional system without further testing.

Zone 3 - Soils in this zone are expected to provide good filtration of effluent, but their ability to accept effluent at a suitable rate is questionable. These soils require wet-weather percolation tests to verify their suitability for effluent disposal by conventional leachfield methods.

Zone 4 - Soils in this zone are unsuitable for a conventional leachfield because of their severe limitations for accepting effluent.



SOILS PERCOLATION TEST DATA SHEET

CLIENT	<u>Arcata Land Company</u>	DATE	<u>4/4/2018</u>
JOB REF.	<u>017062.100</u>	APN	<u>507-181-007</u>
TEST PIT No.	<u>PP-1</u>	TESTED BY	<u>PRS</u>
DEPTH TESTED	<u>12-24"</u>	DTW	<u>>8'</u>
PRE-SOAK	<u>1 Hour</u>		

Reading No.	Start Time	Stop Time	Interval (Minutes)	Water Level Drop (Inches)	Percolation Rate (Minutes per Inch)
1	11:40	11:55	15	1	15
2	11:55	12:10	15	1	15
3	12:10	12:25	15	1	15
4	12:25	12:40	15	1	15
5	12:40	12:55	15	1	15
6	12:55	1:10	15	1	15

STABILIZED PERCOLATION RATE = 15

TEST PIT No.	<u>PP-2</u>	TESTED BY	<u>ESP</u>
DEPTH TESTED	<u>6"-18"</u>	DTW	<u>>8'</u>
PRE-SOAK	<u>1 Hour</u>		

Reading No.	Start Time	Stop Time	Interval (Minutes)	Water Level Drop (Inches)	Percolation Rate (Minutes per Inch)
1	11:40	11:55	15	5	3
2	11:55	12:10	15	6	2.5
3	12:10	12:25	15	5	3
4	12:25	12:40	15	5	3
5	12:40	12:55	15	5	3
6	12:55	1:10	15	5	3

STABILIZED PERCOLATION RATE = 3

TEST PIT No.	<u>PP-3</u>	TESTED BY	<u>PRS</u>
DEPTH TESTED	<u>12"-24"</u>	DTW	<u>>8'</u>
PRE-SOAK	<u>1Hour</u>		

No.	Time	Time	(Minutes)	Drop (Inches)	(Minutes per Inch)
1	11:42	11:57	15	4	3.75
2	11:57	12:12	15	4	3.75
3	12:12	12:27	15	4	3.75
4	12:27	12:42	15	4	3.75
5	12:42	12:57	15	4	3.75
6	12:57	1:12	15	4	3.75

STABILIZED PERCOLATION RATE = 4





SOILS PERCOLATION TEST DATA SHEET

CLIENT	<u>Arcata Land Company</u>	DATE	<u>4/4/2018</u>
JOB REF.	<u>017062.100</u>	APN	<u>507-181-007</u>
TEST PIT No.	<u>PP-4</u>	TESTED BY	<u>ESP</u>
DEPTH TESTED	<u>6"-18"</u>	DTW	<u>7.9'</u>
PRE-SOAK	<u>1 Hour</u>		

Reading No.	Start Time	Stop Time	Interval (Minutes)	Water Level Drop (Inches)	Percolation Rate (Minutes per Inch)
1	11:42	11:57	15	4	3.75
2	11:57	12:12	15	5	3
3	12:12	12:27	15	4	3.75
4	12:27	12:43	15	4	3.75
5	12:43	12:57	15	4	3.75
6	12:57	1:12	15	4	3.75

STABILIZED PERCOLATION RATE = 4

TEST PIT No.	<u>PP-5</u>	TESTED BY	<u>PRS</u>
DEPTH TESTED	<u>12"-24"</u>	DTW	<u>>8'</u>
PRE-SOAK	<u>1 Hour</u>		

Reading No.	Start Time	Stop Time	Interval (Minutes)	Water Level Drop (Inches)	Percolation Rate (Minutes per Inch)
1	11:43	11:58	15	6	2.5
2	11:58	12:13	15	6	2.5
3	12:13	12:28	15	6	2.5
4	12:28	12:43	15	5.5	2.73
5	12:43	12:58	15	5.5	2.73
6	12:58	1:12	15	5.5	2.73

STABILIZED PERCOLATION RATE = 3

TEST PIT No.	<u>PP-6</u>	TESTED BY	<u>ESP</u>
DEPTH TESTED	<u>6"-18"</u>	DTW	<u>7.75'</u>
PRE-SOAK	<u>1Hour</u>		

No.	Time	Time	(Minutes)	Drop (Inches)	(Minutes per Inch)
1	11:43	11:58	15	4	3.75
2	11:58	12:13	15	4	3.75
3	12:13	12:28	15	4	3.75
4	12:28	12:43	15	4	3.75
5	12:43	12:58	15	4	3.75
6	12:58	1:12	15	4	3.75

STABILIZED PERCOLATION RATE = 4



Observation Well Data

				017062.100 Arcata Land Company				APN: 507-181-007							
Observation Well ID				OW-1		OW-2		OW-3		OW-4		OW-5		OW-6	
Total well depth (Feet)				10.00		10.00		10.00		10.00		10.00		10.00	
Height of top of casing above ground (Feet)				2.1		1.6		2.05		1.75		2.15		1.85	
Well depth below ground surface (Feet)				7.90		8.40		7.95		8.25		7.85		8.15	
DATE	PRECIPITATION (IN)		TIME												
(mm/dd/yr)	Daily	Total	(am/pm)	Reading	Depth bags	Reading	Depth bags	Reading	Depth bags	Reading	Depth bags	Reading	Depth bags	Reading	Depth bags
03/27/18	0.00	33.18	pm	ND	ND	9.6	8	ND	ND	9	7.25	ND	ND	ND	ND
04/09/18	2.52 ¹	35.72	pm	ND	ND	9.3	7.7	ND	ND	9.4	7.65	9.8	7.65	8.9	7.05
04/13/18	1.38 ²	37.1	am	ND	ND	9.1	7.5	ND	ND	9.1	7.35	9.8	7.65	8.55	6.7
04/30/18	0.87 ³	38.52	pm	ND	ND	9.6	8	ND	ND	9.8	8.05	9.8	7.65	9.55	7.7

Reading = measured reading of groundwater relative to the top of well casing in feet.

Depth = depth to groundwater below the ground surface in feet.

ND = non-detection of groundwater (dry well).

¹ 2.52 inches of rain over the previous 96 hours

² 1.38 inches of rain over the previous 72 hours

³ 0.87 inches of rain in the previous 72 hours

**Percolation Test Data
(Parcel D)**

2



SOILS PERCOLATION TEST DATA SHEET

CLIENT	<u>Arcata Land Co.</u>	DATE	<u>3/13/2020</u>
JOB REF.	<u>017062.100</u>	APN	<u>506-231-011 Parcel D</u>
TEST PIT No.	<u>PP-21</u>	TESTED BY	<u>E. Phillips</u>
DEPTH TESTED	<u>34"-40"</u>	DTW	<u>>6 feet</u>
PRE-SOAK	<u>1 Hour</u>		

Reading No.	Start Time	Stop Time	Interval (Minutes)	Water Level Drop (Inches)	Percolation Rate (Minutes per Inch)
1	11:25	11:40	15	1/2	30
2	11:40	11:55	15	3/4	20
3	11:55	12:10	15	1/2	30
4	12:10	12:25	15	1/2	30
5	12:25	12:40	15	1/2	30
6	12:40	12:55	15	1/2	30

STABILIZED PERCOLATION RATE = 30

TEST PIT No.	<u>PP-22</u>	TESTED BY	<u>E. Phillips</u>
DEPTH TESTED	<u>30"-36"</u>	DTW	<u>>6 feet</u>
PRE-SOAK	<u>1 Hour</u>		

Reading No.	Start Time	Stop Time	Interval (Minutes)	Water Level Drop (Inches)	Percolation Rate (Minutes per Inch)
1	11:30	11:45	15	1 1/4	12
2	11:45	12:00	15	1 1/4	12
3	12:00	12:15	15	1	15
4	12:15	12:30	15	1	15
5	12:30	12:45	15	1	15
6	12:45	13:00	15	1	15

STABILIZED PERCOLATION RATE = 15

TEST PIT No.	<u>PP-23</u>	TESTED BY	<u>E. Phillips</u>
DEPTH TESTED	<u>32"-38"</u>	DTW	<u>>6 feet</u>
PRE-SOAK	<u>1 Hour</u>		

Reading No.	Start Time	Stop Time	Interval (Minutes)	Water Level Drop (Inches)	Percolation Rate (Minutes per Inch)
1	11:35	11:50	15	2	8
2	11:50	12:05	15	2	8
3	12:05	12:20	15	1 3/4	9
4	12:20	12:35	15	1 3/4	9
5	12:35	12:50	15	1 3/4	9
6	12:50	13:05	15	1 3/4	9

STABILIZED PERCOLATION RATE = 9

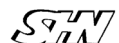

TEST PIT No. PP-24
 DEPTH TESTED 32"-38"
 PRE-SOAK 1 Hour

TESTED BY E. Phillips
 DTW >6 feet

Reading No.	Start Time	Stop Time	Interval (Minutes)	Water Level Drop (Inches)	Percolation Rate (Minutes per Inch)
1	14:05	14:20	15	2 3/4	5
2	14:20	14:35	15	2 1/2	6
3	14:35	14:50	15	2 1/4	7
4	14:50	15:05	15	2	8
5	15:05	15:20	15	2	8
6	15:20	15:35	15	2	8

STABILIZED PERCOLATION RATE = 8

**Laboratory Textural Analysis
(Parcel D)**

3



Reference: 017062.100

SOIL PERCOLATION SUITABILITY / TEXTURAL ANALYSIS RESULTS

Job Name: Arcata Land Co. Sampled By: ESP
Date Sampled: 03/13/20 Date Tested: 03/19/20
Date Received: 03/13/20 AP Number: 506-231-011

<u>Sample ID</u>	<u>Depth</u>	<u>% Sand</u>	<u>% Clay</u>	<u>% Silt</u>	<u>% Coarse Fragments by Volume</u>	<u>Zone</u>	<u>Bulk Density</u>
PP-21	36"	33.7	24.8	41.5	0.0	3	*
	Material: Loam						
PP-22	32"	28.1	21.8	50.1	0.0	3	*
	Material: Silt Loam						
PP-23	32"	26.8	26.4	46.8	0.0	3	*
	Material: Loam						
PP-24	34"	16.6	34.9	48.5	0.0	4	*
	Material: Silty Clay Loam						
TP-25	32"	43.5	18.6	37.9	0.0	2	*
	Material: Loam						

* = no peds provided

Regional Water Quality Control Board Zone Descriptions:

Zone 1 - Soils in this zone are very high in sand content. They readily accept effluent, but because of their low silt and clay content they provide minimal filtration. These soils demand greater separation distances from groundwater.

Zone 2 - Soils in this zone provide adequate percolation rates and filtration of effluent. They are suitable for use of a conventional system without further testing.

Zone 3 - Soils in this zone are expected to provide good filtration of effluent, but their ability to accept effluent at a suitable rate is questionable. These soils require wet-weather percolation tests to verify their suitability for effluent disposal by conventional leachfield methods.

Zone 4 - Soils in this zone are unsuitable for a conventional leachfield because of their severe limitations for accepting effluent.

SOIL PERCOLATION SUITABILITY CHART

LEGEND		
HOLE	DEPTH	SYMBOL
PP-21	36"	■
PP-22	32"	●
PP-23	32"	▲
PP-24	34"	◆
TP-25	32"	✱

Zone 1 = Coarse
Zone 2 = Acceptable
Zone 3 = Marginal
Zone 4 = Unacceptable

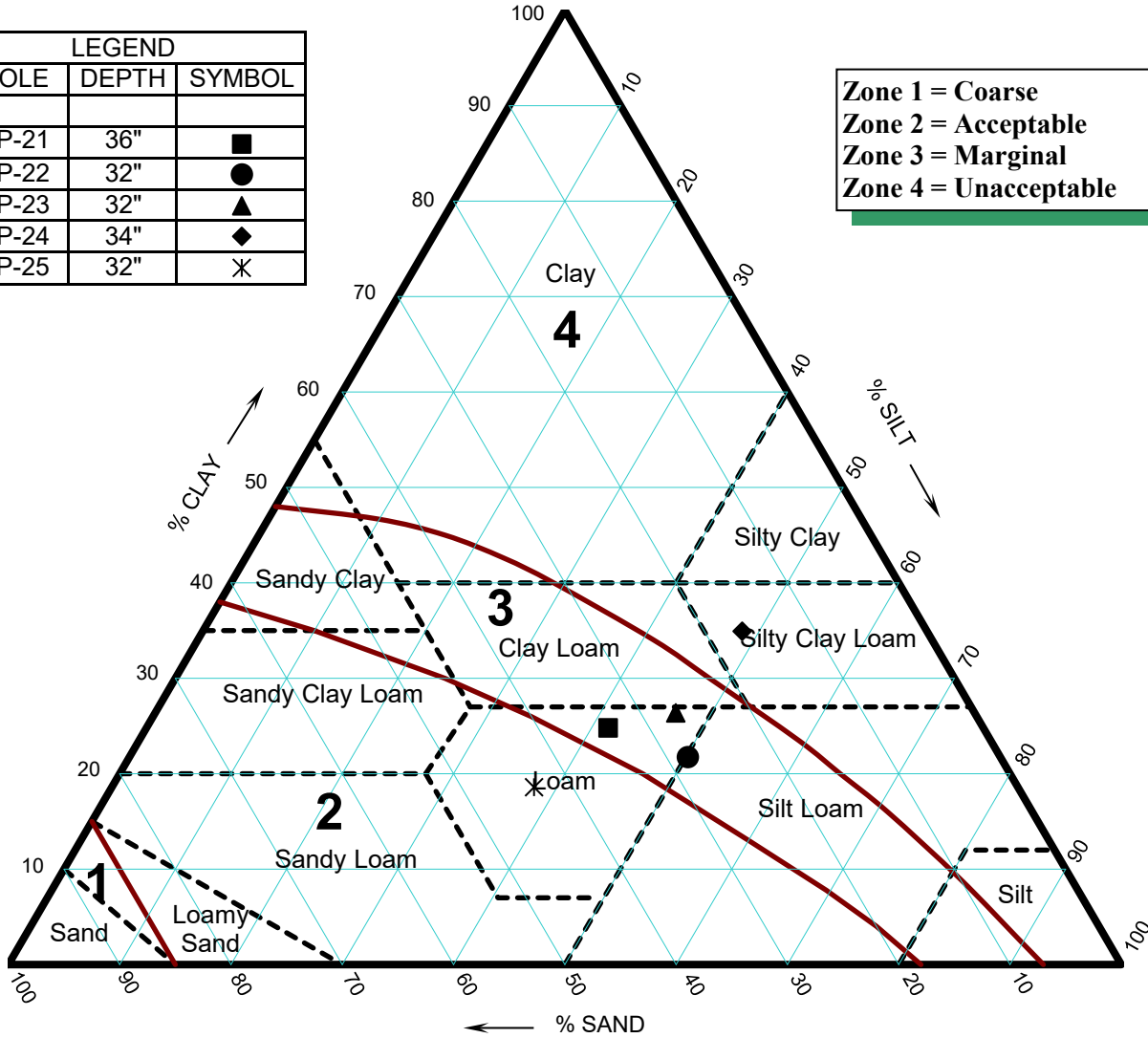

NOTES

1. Soil texture is plotted on triangle based on percent sand, silt, and clay as determined by hydrometer analysis.
2. Adjustment for coarse fragments has been made by moving the plotted point in the sand direction an additional 2% for each 10% (by volume) of fragments greater than 2mm in diameter.
3. Adjustment for compactness of soil has been made by moving the plotted point in the clay direction an additional 15% for soils having a bulk-density greater than 1.7 gm/cc, when analyzed.
4. For soils falling in sand, loamy sand, or sandy loam, classification adjustment for bulk density will generally not affect suitability and a bulk-density analysis was not necessary.

JOB NUMBER: 017062.100
JOB NAME: Arcata Land Co.

DATE: 03/19/20
APN: 506-231-011



**Pressure Distribution
System Design Calculations
and Specifications (Parcel D)**

4



Low-Pressure Pipe Distribution Network Design Calculations and Specifications

Project No.: 0017062.100
Date: May 2020
Client: Arcata Land Co., LLC
Prepared by: Giovanni Vadurro, CEG 2554
Location: Arcata, Humboldt County; Portion of APN 506-231-011, Parcel D

Setbacks for Subsurface Disposal Field:

Wetlands: >100 feet
Perennial Stream: >100 feet
Ephemeral Stream: >50 feet
Springs: >50 feet
Wells: >100 feet
Property Line: >10 feet
Foundation of Building: >10 feet
Slope breaks in excess of 25°: >100 feet

Design Criteria:

Depth to seasonal high groundwater: 6± feet below ground surface
USDA Soil Classification: Loam (Zone 2/3), Silt Loam (Zone 3), Silty Clay Loam (Zone 4)
Measured Percolation Rates: 8 to 30 minutes per inch (MPI)
Soil Application Rate: 0.363 gpd/ ft² based on slowest percolation rate
Wastewater Flow in gallons per day (gpd): 4,060 gpd

Summary of Pressurized Distribution System Specifications:

- Septic Tank, Pump Vaults, and Pump system:
 - Septic Tank: 12,000-gallon, 2-compartment fiberglass tank with three risers
 - Pump Vault: 4,000-gallon single-compartment pre-cast concrete tank or fiberglass tank with two risers
 - High Head Effluent Pump: Orenco PI5007 High Head Effluent Pump 50 GPM, 3/4HP 220V 1Ø 50Hz
 - Distributing Valve: Orenco V6404A Automatic Distributing Valve 1.5" Inlet & Outlets 15-100 GPM Flow Range 4 Zone
- Pressurized Distribution System:
 - Number of Pressurized Distribution Laterals and Length = 32 x 70 feet
 - Split into 4 separate distribution cells with 8 laterals each connected to end-feed manifolds
- Trench Depth = 36 inches
- Trench Width = 24 inches
- Trench Backfill: 3/8-inch washed pea gravel (18-inches below pipe and 6-inches of pipe cover)

Low-Pressure Pipe Distribution Design Calculations

May 2020

Page 2

- Spacing between Laterals = **8 feet** (center to center)
- Distribution Lateral Diameter = **1 ¼-inch Sch. 40 PVC**
- Orifice Diameter and Spacing = **1/8-inch with 5-foot spacing**
- End-feed Manifold Length and Diameter = **24 feet of 1 ½-inch Sch. 40 PVC**
- Transport Pipe Length and Diameter = **1,200 feet of 3-inch HDPE Pipe** (contractor to verify length in field based on distance from pump tank to distributing valve)

Low-Pressure Pipe Distribution Network Design Calculations:

- (1) Daily flow rate in gallons per day (gpd):
 - (116 workers x 35 gpd per person) = **4060 gpd**
- (2) Field measured percolation rate in minutes per inch (MPI):
 - **8 to 30 MPI**
- (3) Soil Application Rate in gallons per day per square foot (gpd/ft²) based on 30 MPI percolation rate:
 - **0.363 gpd/ ft²**
- (4) Total trench sidewall and trench bottom area required below the pressurized pipe:
 - = Daily design wastewater flow rate / Soil Application Rate:
 - = (4,060 gpd) ÷ (0.363 gpd/ft²)
 - = **11,185 ft²**
- (5) Length of pressurized distribution lateral required using 18-inches of pea gravel below the pipe and 24-inch wide trenches (use trench sidewall and bottom area of **5 ft² per lineal foot of trench**):
 - = (11,185 ft²) ÷ (5 feet)
 - = **2,237 feet (Use 2,240 ft)**
- (6) Pressurized Distribution Dispersal Field Dimensions:
 - **Use thirty-two (32) 70-foot pressurized distribution laterals spaced 8-foot center-to-center**
 - **Divide into eight (8) separate cells each containing eight (8) distribution laterals of seventy feet (70) in length**
 - **Maintain 10-foot horizontal separation at cell boundaries**
 - **The total area required per cell is approximately 3,480 ft² (145 feet x 24 feet)**
- (7) Orifice diameter and spacing for pressurized laterals:
 - Design using 3-foot pressure head at discharge
 - Use **1/8-inch diameter orifices with 5-foot spacing** (begin orifice placement 2.5-feet from ends of laterals)
 - Number of orifices per 70 feet of pressurized lateral = **14 orifices**
- (8) Discharge rate per orifice in gallons per minute (gpm):
 - Use 3-foot pressure head with 1/8-inch orifice diameter
 - $Q = (A \times (2gh)^{0.5}) \times C_d$
 - $Q = (8.52 \times 10^{-5} \text{ ft}^2 \times 13.9 \text{ ft/s}) \times 0.61 = 7.22 \times 10^{-4} \text{ ft}^3/\text{s} = \mathbf{0.34 \text{ gpm}}$
- (9) Discharge rate per lateral:
 - Flow rate per orifice = 0.32 gpm
 - Flow rate per 70 feet of lateral = 0.34 gpm/orifice x 14 orifices = **4.8 gpm per lateral**
- (10) Discharge rate for each distribution cell:
 - Eight (8) laterals x 4.8 gpm/lateral = **38 gpm**
- (11) Transport Line Diameter and Length:

- **Use solid 3-inch diameter HDPE Pipe** for transport line from pump to six-way automatic distributing valve
 - **Use length of approximately 1,200 feet** (Contractor to verify length in field)
- (12) Manifold Diameter and Length:**
- **Use solid 1 ½-inch diameter Schedule 40 PVC** for end-feed manifolds
 - **Use manifold lengths of 24 feet**
- (13) Pressurized Lateral Diameter and Length:**
- Use **1 ¼-inch diameter Schedule 40 PVC** for each pressurized lateral
 - Use **32 pressurized laterals** with length of **70 feet** each
 - Split into four (4) separate distribution cells with eight (8) laterals each; each set of laterals to be connected to the end-feed manifold; manifolds are to be connected to the automatic distributing valve assembly.
- (14) Friction Head Losses:**
- Loss through discharge: **2.8 ft**
 - Loss in transport pipe before valve: **4.2 ft**
 - Loss through distributing valve: **9.5 ft**
 - Loss in transport pipe after valve: **5.3 ft**
 - Loss in manifold: **0.5 ft**
 - Loss in laterals: **0.1 ft**
 - Add-on friction losses: **10 ft**
 - Maximum elevation lift: **10 ft**
 - Residual head at last orifice: **3 ft**
 - **Total Head Loss = 46 ft±**
- (15) Pump Selection:**
- Size pump for design flow rate of 38 gpm against 46 feet total dynamic head
 - Use Orenco PI5007 High Head Effluent Pump 50 GPM, 3/4HP 220V 1Ø 50Hz
- (16) Dose Volume and Frequency:**
- Volume of transport line before valve = 460 gallons
 - Volume of transport line after valve = 39 gallons
 - Volume of manifold = 2.5 gallons
 - Volume of laterals per zone = 40.4 gallons
 - Total volume before valve = 460 gallons
 - Total volume after valve = 82 gallons
 - Use dose volume = **500 gallons**
 - 4060 gpd/500 gal/dose = **8 doses per day**

**Civil Plan Sheets G-1, G-2,
C-1, C-2, C-3, C-4 and C-5
(Parcel D)**

5

ARCATA LAND COMPANY, LLC APN 506-231-011, PARCEL D

ONSITE WASTEWATER TREATMENT AND DISPOSAL SYSTEM DESIGN

ARCATA, CALIFORNIA

PREPARED BY:



JUNE 2020

APPROVALS

GIOVANNI A. VADURRO
SHN CONSULTING ENGINEERS AND GEOLOGISTS
ENGINEERING GEOLOGIST

DATE

INDEX OF SHEETS

SEQ	SHEET	TITLE
1	G-1	COVER
2	G-2	STANDARD ABBREVIATIONS AND LEGENDS
3	C-1	SITE PLAN
4	C-2	SEPTIC TANK DETAILS
5	C-3	PUMP TANK DETAILS
6	C-4	DISPOSAL SYSTEM DETAILS
7	C-5	BUOYANCY CALCULATIONS

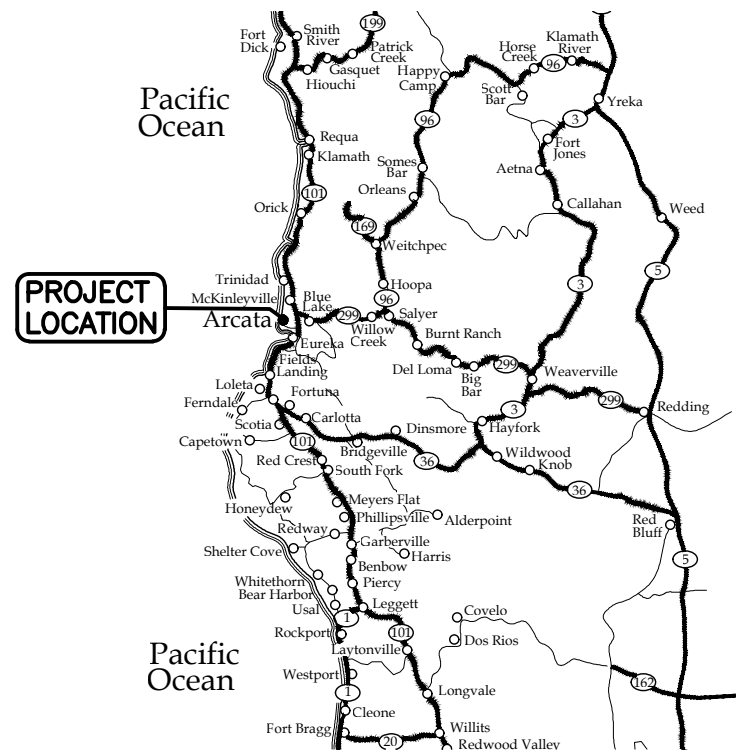

LOCATION MAP

NTS



VICINITY MAP

NTS



Know what's below.
Call before you dig.

Contractor shall call
Underground Service Alert at
811 two working days prior
to excavation.
Landline: 1-800-227-2600

SAVED: 6/12/2020 2:06 PM CSWANSON, PLOTTED: 6/12/2020 2:07 PM CHUCK SWANSON
 \\Eureka\Projects\2017\017062-ArcataLandCo\100-Leachfield\Draws\506-231-011\017062-100-COVER.dwg

VERIFY SCALES
 1" = 100' AS SHOWN ON ORIGINAL DRAWING
 IF NOT ONE INCH ON THIS SHEET, ADJUST SCALES ACCORDINGLY

812 W. WABASH AVE.
 EUREKA, CA 95501
 WWW.SHN-ENGR.COM
 707-441-8655



NO.	DATE	REVISION	BY

APVD	GAY	CHK	CRS	DR	GAY	DSN

ARCATA LAND COMPANY, LLC
 ONSITE WASTEWATER TREATMENT AND DISPOSAL SYSTEM
 ARCATA, CALIFORNIA

SHEET	G-1
SEQ	1
DATE	06/2020
PROJ. NO.	017062.100

COVER

SAVED: 6/12/2020 2:05 PM CSWANSON, PLOTTED: 6/12/2020 2:05 PM CHUCK SWANSON
 \\Eureka\Projects\2017\017062-ArcataLandCo\100-Leachfield\Draws\506-231-011\017062-100-SITE.dwg

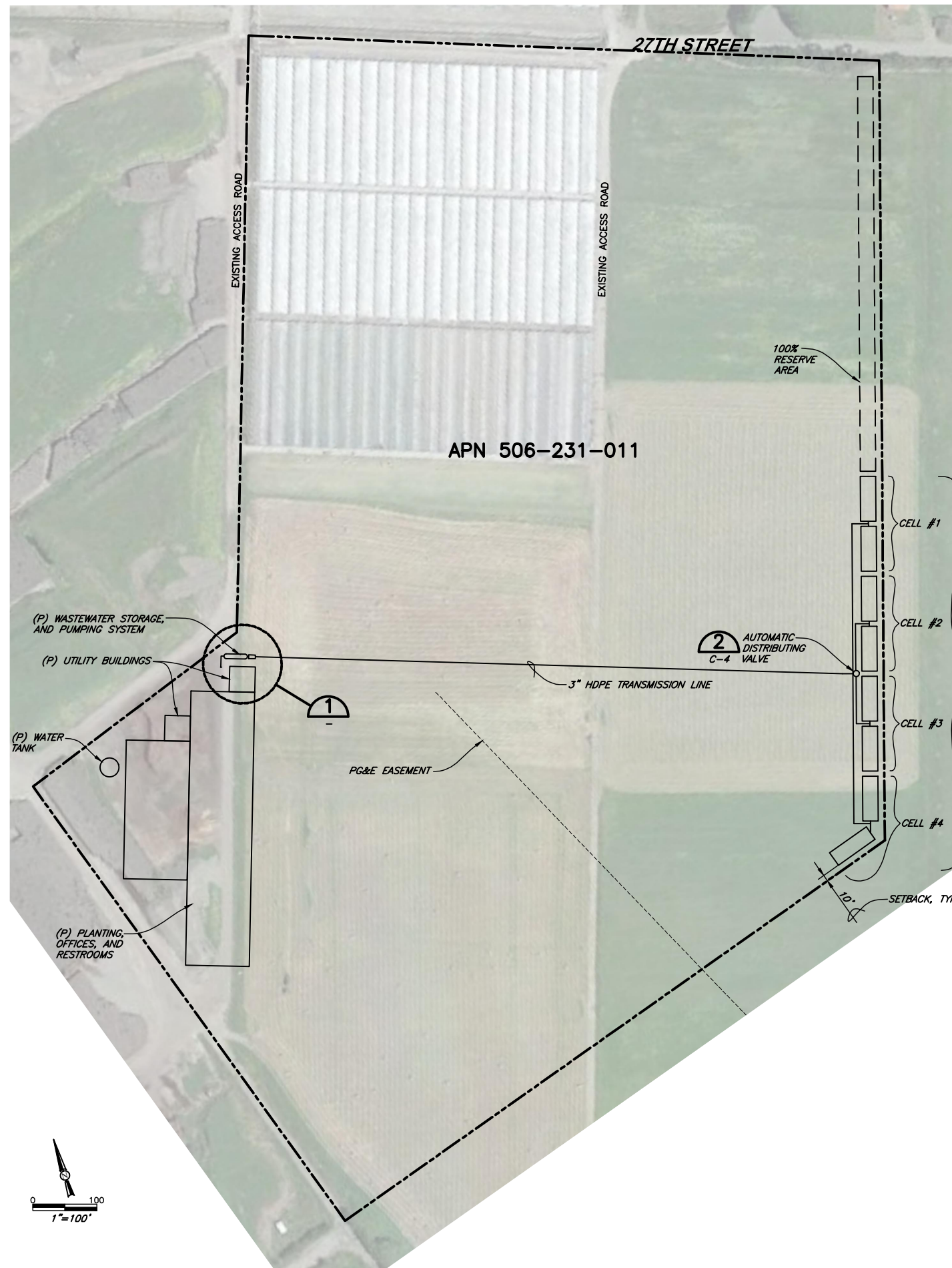

GENERAL NOTES:

1. THE WORKING DRAWINGS ARE GENERALLY DIAGRAMMATIC. THEY DO NOT SHOW EVERY OFFSET, BEND OR ELBOW REQUIRED FOR INSTALLATION IN THE SPACE PROVIDED. THEY DO NOT SHOW EVERY DIMENSION, COMPONENT PIECE, SECTION, JOINT OR FITTING REQUIRED TO COMPLETE THE PROJECT. ALL LOCATIONS FOR WORK SHALL BE CHECKED AND COORDINATED WITH EXISTING CONDITIONS IN THE FIELD BEFORE BEGINNING CONSTRUCTION. EXISTING UNDERGROUND UTILITIES WITHIN THE LIMITS OF EXCAVATION SHALL BE VERIFIED AS TO CONDITION, SIZE AND LOCATION BY UNCOVERING, PROVIDED SUCH IS PERMITTED BY LOCAL PUBLIC AUTHORITIES WITH JURISDICTION, BEFORE BEGINNING CONSTRUCTION. CONTRACTOR SHALL NOTIFY ENGINEER OF ANY DISCREPANCIES.
2. THE CONTRACTOR SHALL SECURE ALL NECESSARY PERMITS PRIOR TO THE COMMENCEMENT OF CONSTRUCTION.
3. THE CONTRACTOR SHALL PROVIDE A COPY OF THE TRENCH PERMIT FROM THE CALIFORNIA DIVISION OF INDUSTRIAL SAFETY PRIOR TO THE EXCAVATION OF ANY TRENCH OVER FIVE FEET IN DEPTH.
4. CONTRACTOR SHALL PERFORM TRENCH WORK IN CONFORMANCE WITH THE CALIFORNIA DIVISION OF INDUSTRIAL SAFETY REQUIREMENTS. SAID SHALL CONFORM TO ALL APPLICABLE OCCUPATIONAL SAFETY AND HEALTH STANDARDS, RULES, REGULATIONS AND ORDERS ESTABLISHED BY THE STATE OF CALIFORNIA AND OTHER APPLICABLE AGENCIES.
5. CONTRACTOR AGREES THAT IN ACCORDANCE WITH GENERALLY ACCEPTED CONSTRUCTION PRACTICES, GENERAL CONTRACTOR WILL ASSUME SOLE AND COMPLETE RESPONSIBILITY FOR JOB SITE CONDITIONS DURING THE COURSE OF CONSTRUCTION OF THE PROJECT, INCLUDING SAFETY OF ALL PERSONS AND PROPERTY. ALL WORK AND EQUIPMENT SHALL COMPLY WITH THE CALIFORNIA DIVISION OF INDUSTRIAL SAFETY REQUIREMENTS. THIS REQUIREMENT SHALL BE MADE TO APPLY CONTINUOUSLY, AND NOT BE LIMITED TO NORMAL WORKING HOURS. CONTRACTOR FURTHER AGREES TO HOLD HARMLESS, INDEMNIFY AND DEFEND THE OWNER, THE ENGINEER AND HIS/HER CONSULTANTS.
6. THE CONTRACTOR SHALL INDEPENDENTLY REVIEW GROUND, TOPOGRAPHY THROUGHOUT THE SITE, AND ASSUME THE RISK OF COMPLETING THE WORK SET OUT ON THESE PLANS, REGARDLESS OF ROCK, WATER TABLE OR OTHER CONDITIONS WHICH MAY BE ENCOUNTERED IN THE COURSE OF THE WORK.
7. ANY DISCREPANCY DISCOVERED BY THE CONTRACTOR IN THESE PLANS, OR ANY FIELD CONDITIONS DISCOVERED BY THE CONTRACTOR THAT MAY DELAY OR OBSTRUCT THE PROPER COMPLETION OF THE WORK SHOWN HEREIN SHALL BE BROUGHT TO THE ATTENTION OF THE OWNER AND THE ENGINEER IMMEDIATELY UPON DISCOVERY. SAID NOTIFICATION SHALL BE IN WRITING.
8. PAVED AREAS AT THE ACCESS POINTS SHALL BE SWEEPED OR VACUUMED AS OFTEN AS EACH DAY TO ELIMINATE TRACKING SOIL AND DEBRIS ONTO THE PUBLIC STREETS. ANY SOILS AND/OR DEBRIS, ROCK, GRAVEL, ETC. TRACKED ONTO PUBLIC STREET AS A RESULT OF THIS PROJECT SHALL BE REMOVED IMMEDIATELY. PAVED AREAS WITHIN THE RIGHT OF WAY SHALL BE LEFT IN A CLEANED CONDITION AT THE END OF EACH WORK DAY.
9. ALL UNDERGROUND IMPROVEMENTS SHALL BE INSTALLED TESTED AND APPROVED PRIOR TO PAVING OR BACKFILLING.
10. THE CONTRACTOR SHALL NOT BEGIN EXCAVATING UNTIL ALL EXISTING UTILITIES HAVE BEEN MARKED IN THE FIELD. THE CONTRACTOR SHALL NOTIFY EACH APPLICABLE ENTITY AT LEAST 48 HOURS PRIOR TO COMMENCING WORK. CALL UNDERGROUND SERVICE ALERT (USA) TWO WORKING DAYS BEFORE DIGGING AT (800) 227-2600 FOR LOCATES.
11. GRADING AND CONSTRUCTION CONTRACTORS SHALL STOP WORK IF CULTURAL RESOURCES ARE DISCOVERED DURING CONSTRUCTION.
12. THE CONTRACTOR SHALL GIVE THE INSPECTOR 48 HOURS ADVANCE NOTICE OF ANY CONSTRUCTION OR REQUIRED TESTING.
13. THE CONTRACTOR SHALL INSTALL APPROVED PHYSICAL BARRIERS TO ENSURE THAT ALL DEBRIS IS CAPTURED AND REMOVED FROM SURFACE RUNOFF PRIOR TO RELEASING SITE RUNOFF.
14. ALL SITE GRADING WILL BE INSPECTED BY THE ENGINEER. COMPACTION TESTING WILL BE CONDUCTED AFTER SUFFICIENT DENSITIES HAVE BEEN ACHIEVED IN THE CONTRACTOR'S OPINION. THE CONTRACTOR SHALL MAKE ALL REQUESTS FOR MATERIALS TESTING AT LEAST 48 HOURS IN ADVANCE. ANY SOILS THAT FAIL TO MEET THE REQUIRED COMPACTION LEVELS SHALL BE REWORKED, AND RECOMPACTED. ALL COSTS ASSOCIATED WITH ACHIEVING COMPACTION STANDARDS SHALL BE INCLUDED IN THE CONTRACTOR'S ORIGINAL BID.
15. THE TOPSOIL SHALL BE REMOVED FROM CUT AND FILL AREAS AND SHALL NOT BE USED FOR ENGINEERED FILL. TOPSOIL SHALL BE STOCKPILED SEPARATELY AND REPLACED OVER AREAS OF EXPOSED SUBGRADE TO A MINIMUM DEPTH OF 6 INCHES.
16. NO CHANGES OR MODIFICATIONS SHALL BE MADE TO THESE PLANS WITHOUT WRITTEN APPROVAL BY THE ENGINEER.
17. TOPSOIL AND VEGETATION OUTSIDE OF CONSTRUCTION SHALL NOT BE DISTURBED.

DISPOSAL FIELD NOTES:

1. PRESSURE HEAD OF 3FT SHALL BE MAINTAINED AT END OF FURTHEST LINE IN DISTRIBUTION SYSTEM. CONTRACTOR TO VERIFY THIS REQUIREMENT IS MET IN THE FIELD.
2. ALL VALVE AND IRRIGATION BOXES ARE TO BE RATED FOR INCIDENTAL H-20 TRAFFIC LOADING.
3. DISPOSAL FIELD SHALL BE CONSTRUCTED USING ONLY HAND TOOLS OR LIGHTWEIGHT TRACK-MOUNTED EQUIPMENT APPROVED BY THE ENGINEER. NO HEAVY EQUIPMENT WILL BE PERMITTED IN THE AREA OF THE DISPOSAL FIELD.
4. EXISTING GROUND OUTSIDE OF THE IMMEDIATE LIMITS OF THE INDIVIDUAL DISPOSAL FIELD AND TRENCHES SHALL REMAIN UNDISTURBED.

EROSION CONTROL NOTES:

1. BMP'S TO BE INSTALLED PRIOR TO SITE BEING DISTURBED AND MAINTAINED SUCH THAT NO VISIBLE SEDIMENT LEAVES THE SITE.
2. TRACKING CONTROLS: ENTRANCE/EXIT.
3. DISTURBED AREAS PROTECTED TO EXTENT PRACTICAL DURING CONSTRUCTION.
4. STOCKPILE MANAGEMENT TO BE IMPLEMENTED.
5. DISTURBED AREA STABILIZED AS SOON AS POSSIBLE.

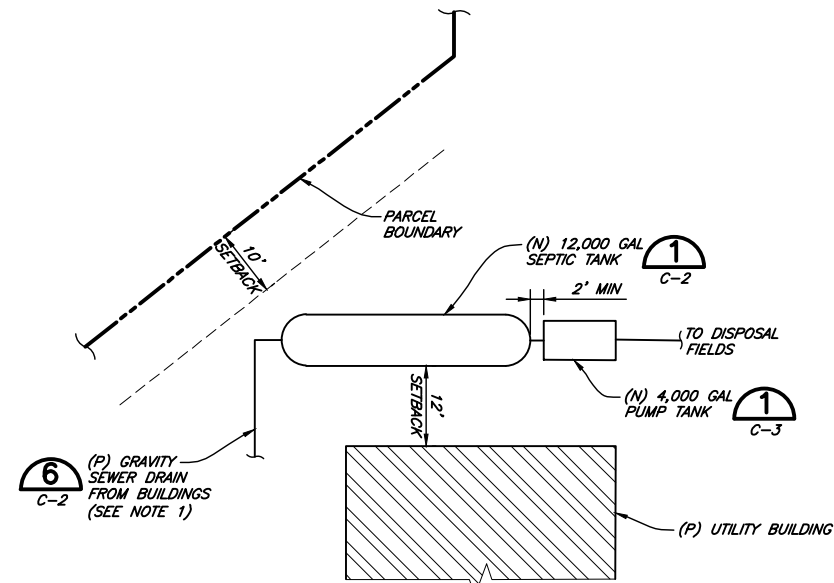

DETAIL 1
 NTS
 (ENLARGED WASTEWATER SYSTEM PLAN)

NOTES:

1. GRAVITY SEWER LATERAL FROM (P) BUILDINGS SHALL MAINTAIN MINIMUM 2% SLOPE, DRAIN FREELY TO (N) SEPTIC TANK, BE 4\"/>

VERIFY SCALES
 BAR IS ONE INCH ON ORIGINAL DRAWING
 IF NOT ONE INCH ON THESE PLANS, SCALES ACCORDINGLY

812 W. WABASH AVE.
 FURRECH, CA 95001
 WWW.SJW.COM
 707-441-8855

SJW

NO.	DATE	BY	REVISION

DSGN: GAY
 DR: CRS
 CHK: GAY
 APVD:

ARCATA LAND COMPANY, LLC
 ONSITE WASTEWATER TREATMENT AND DISPOSAL SYSTEM
 ARCATA, CALIFORNIA

SITE PLAN

SHEET C-1
 SEQ 3
 DATE 06/2020
 PROJ. NO. 017062.100

SAV: 6/12/2020 2:07 PM C:\SWANSON\PROJECTS\6/12/2020 2:07 PM CHUCK SWANSON
 \\Eureka\Projects\2017\017062-ArcataLandCo\100-Leachfield\Drawings\506-231-011\017062-100-TANK-DETL5.dwg

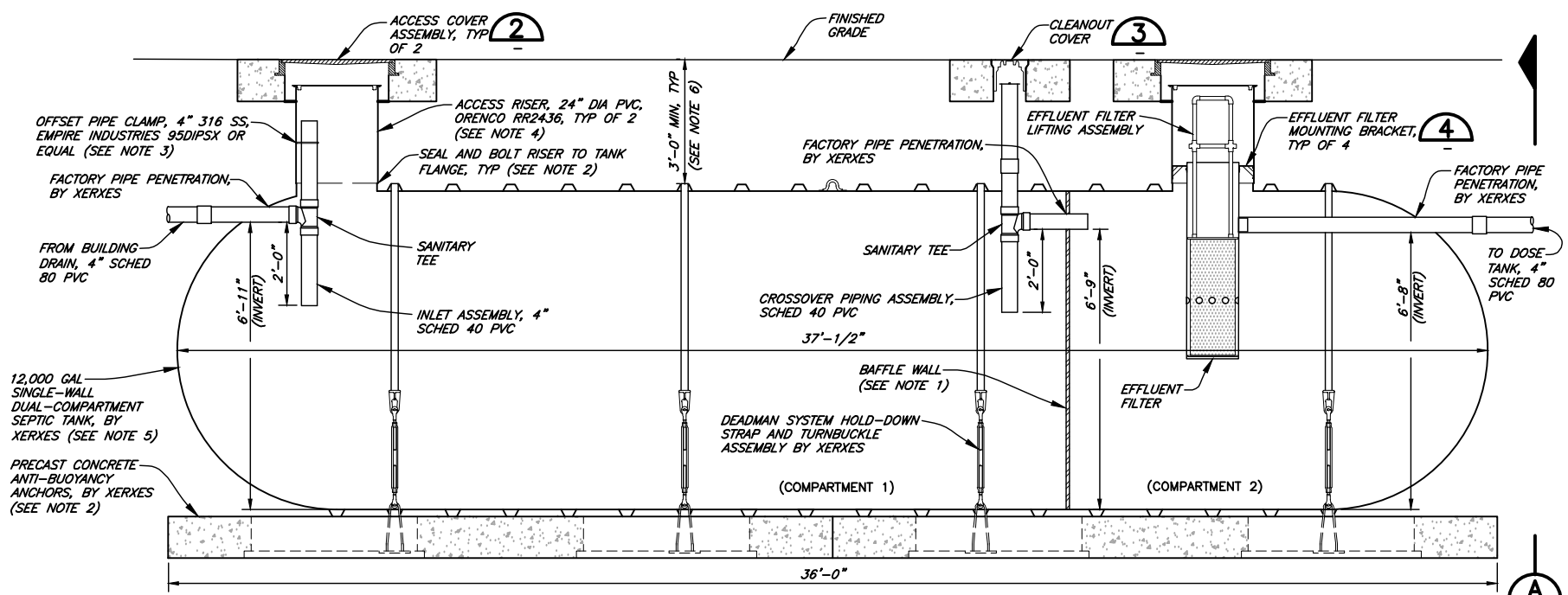

- NOTES:**
1. SEPTIC TANK COMPARTMENT 1 MUST BE TWICE THE VOLUME OF COMPARTMENT 2, AT A MINIMUM.
 2. XERKES TANK, ANCHORS, AND ALL APPURTENANCES SHALL BE INSTALLED IN ACCORDANCE WITH MANUFACTURER'S RECOMMENDATIONS. SEE SHEET C-5 FOR XERKES ANTI-FLOATATION ANCHOR CALCULATIONS.
 3. ALL BOLT HOLES IN TANK RISERS SHALL BE SEALED WATERTIGHT WITH EXTERIOR-GRADE SILICONE SEALANT.
 4. RISER LENGTH, INLET PIPE VERTICAL EXTENSION LENGTH, CROSSOVER PIPE VERTICAL EXTENSION LENGTH, AND EFFLUENT FILTER HANDLE ASSEMBLY LENGTH MAY NEED TO BE LONGER OR CUT TO LENGTH AS-NEEDED TO ALLOW EASY ACCESS FROM FINISHED GRADE. CONTRACTOR TO VERIFY FINISHED GRADE AND DEPTH OF TANK COVER PRIOR TO ORDERING MATERIALS.
 5. DRY TANK WEIGHT IS APPROXIMATELY 7,600 POUNDS.
 6. TANK SHALL BE INSTALLED LEVEL TO ENSURE PROPER GRAVITY PIPE FLOW AND PREVENT BACKFLOW OF SEWAGE INTO THE GRAVITY DRAIN FROM BUILDINGS.

SEPTIC TANK DETAIL 1
NTS C-1

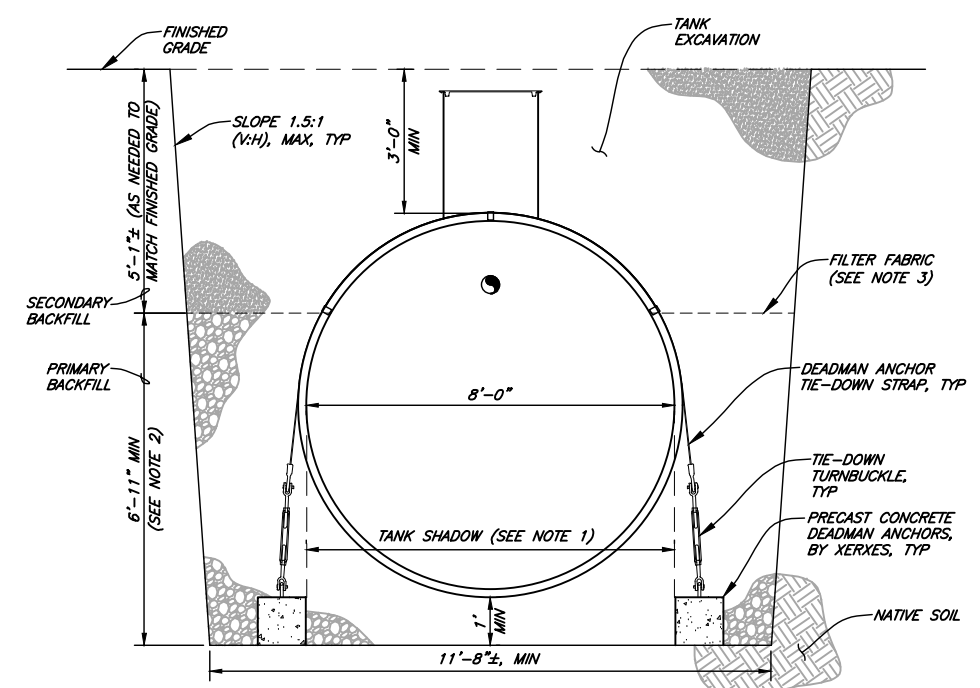

- NOTES:**
1. DEADMAN ANCHORS SHALL NOT BE PLACED INSIDE THE TANK SHADOW.
 2. PRIMARY BACKFILL SHALL EXTEND TO 75% OF THE TANK DIAMETER FROM THE BOTTOM OF THE TANK, AT A MINIMUM.
 3. FILTER FABRIC SEAMS SHALL OVERLAP 12" AT A MINIMUM.
 4. USE HAND-GUIDED VIBRATING PLATE MECHANICAL COMPACTOR FOR SOIL COMPACTION.

SECTION A
NTS

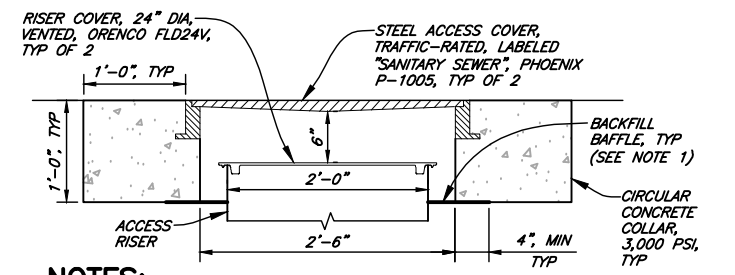

- NOTES:**
1. CIRCULAR BACKFILL BAFFLE SHALL BE CUT TO FIT ACCESS RISER OUTSIDE DIAMETER SNUGLY, AND EXTEND BELOW CONCRETE COLLAR 4" AT A MINIMUM.

ACCESS COVER ASSEMBLY DETAIL 2
NTS

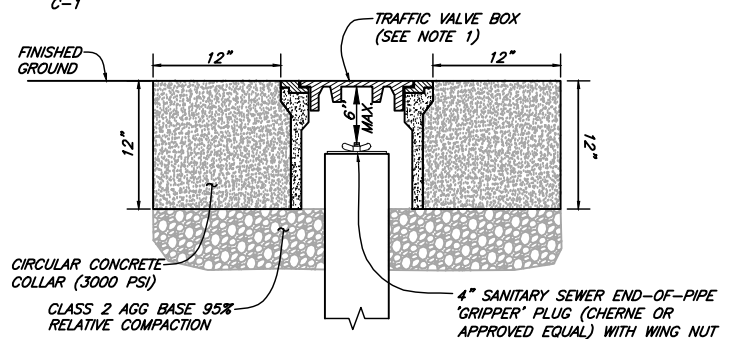

- NOTES:**
1. INSTALL CHRISTY MODEL G5 TRAFFIC VALVE BOX (OR APPROVED EQUAL) AND CAST IRON LID MARKED "SEWER". CENTER THE BOX OVER THE RISER, AND SET THE LID TO FINISHED GRADE.

CLEANOUT COVER DETAIL 3
NTS

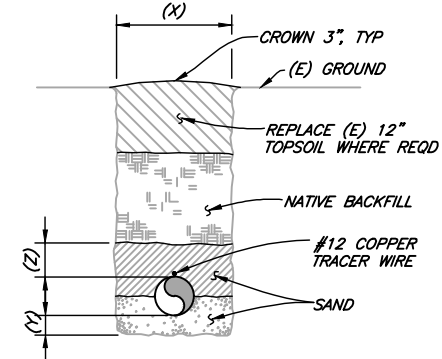

- NOTES:**
1. CROWN AS DIRECTED BY ENGINEER
 2. PROVIDE NECESSARY DRAINAGE AS REQD
 3. REPLACE TOPSOIL AND RESEED PER SPECIFICATIONS
 4. CLEAN UP ALL GRAVEL AND SPOILS

TYPICAL TRENCH DETAIL 6
NTS C-1

PIPE SIZE	(X) TRENCH WIDTH		(Y) BEDDING (MIN)	(Z) COVER (MIN)
	(MIN)	(MAX)		
4"	18"	30"	4"	6"
6"	18"	30"	6"	8"
8"	21"	32"	6"	10"
10"	24"	36"	8"	12"
12"	26"	36"	8"	12"
15"	30"	42"	8"	12"
18"	32"	44"	8"	12"
21"	36"	48"	8"	12"
24"	42"	48"	8"	12"

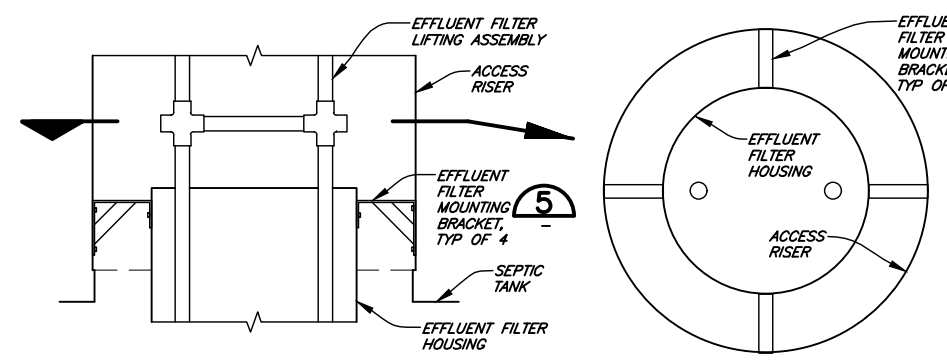

EFFLUENT FILTER MOUNTING BRACKET DETAIL 4
NTS

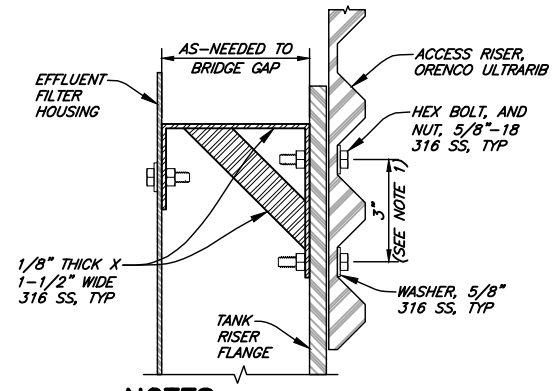

- NOTES:**
1. CONTRACTOR SHALL VERIFY ALL DIMENSIONS IN FIELD.
- DETAIL 5**
NTS

VERIFY SCALES
 1" = 10' INCH ON ORIGINAL DRAWING
 IF NOT ONE INCH ON THIS SHEET, ADJUST SCALES ACCORDINGLY

812 W. WABASH AVE.
 EUREKA, CA 95501
 WWW.SHN-ENGR.COM
 707-441-8655

SHN

NO.	DATE	BY	REVISION

DSSN GAY
 DR CRS
 CHK GAY
 APVD

ARCATATA LAND COMPANY, LLC
 ONSITE WASTEWATER TREATMENT AND DISPOSAL SYSTEM
 ARCATATA, CALIFORNIA

SEPTIC TANK DETAILS

SHEET C-2
 SEQ 4
 DATE 06/2020
 PROJ. NO. 017062.100

SAVED: 6/12/2020 2:08 PM CSWANSON, PLOTTED: 6/12/2020 2:08 PM CHUCK SWANSON
 \\Eureka\Projects\2017\017062-ArcataLandCo\100-Leachfield\Draws\506-231-011\017062-100-TANK-DETAILS.dwg

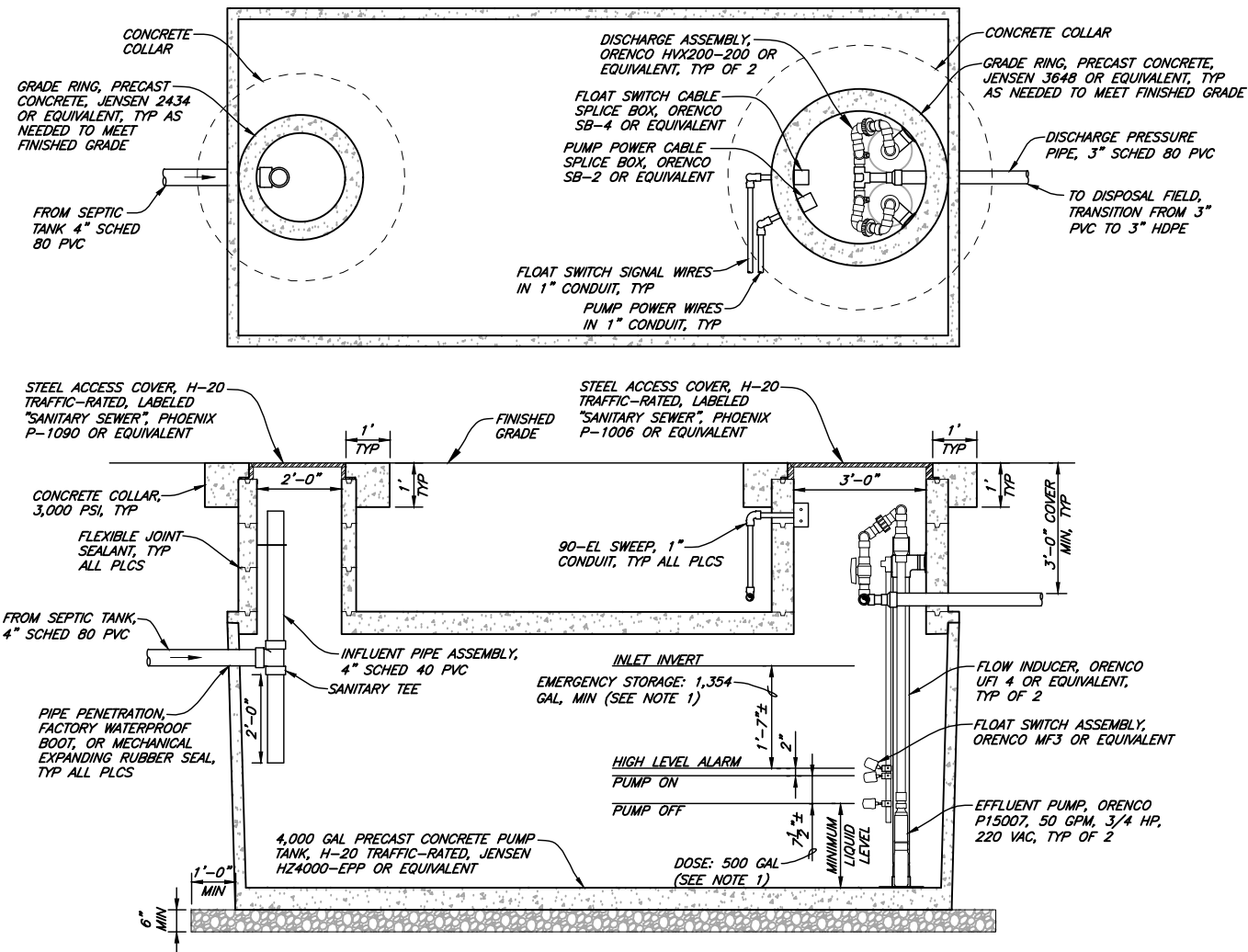

NOTES:

1. VOLUME DIMENSIONS ARE APPROXIMATE AND MAY VARY BASED ON THE ACTUAL DIMENSIONS OF THE TANK. EMERGENCY STORAGE VOLUME AND DOSE VOLUME SHALL BE CONFIRMED BASED ON THE ACTUAL DIMENSIONS OF THE TANK INSTALLED.
2. TANK SHALL BE LEAK TESTED IN ACCORDANCE WITH HUMBOLDT COUNTY DEPARTMENT OF ENVIRONMENTAL HEALTH ONSITE WASTEWATER TREATMENT SYSTEM GUIDELINES.(2017) SECTION 4.3.
3. VALVE VAULT LID SHALL BE INSTALLED IN PRECAST CONCRETE VAULT COVER IN ACCORDANCE WITH MANUFACTURER INSTRUCTIONS.

PUMP TANK DETAIL 1

NTS

C-1

VERIFY SCALES
 1" = 1'-0" INCH ON ORIGINAL DRAWING
 IF NOT ONE INCH ON THIS SHEET, ADJUST SCALES ACCORDINGLY

812 W. WABASH AVE.
 EUREKA, CA 95501
 WWW.SHN-ENGR.COM
 707-441-8655



NO.	DATE	REVISION	BY

DSGN	GAY
DR	CRS
CHK	GAY
APVD	

ARCATA LAND COMPANY, LLC
 ONSITE WASTEWATER TREATMENT AND DISPOSAL SYSTEM
 ARCATA, CALIFORNIA

DOSE TANK DETAILS

SHEET	C-3
SEQ	5
DATE	06/2020
PROJ. NO.	017062.100

SAVED: 6/12/2020 2:09 PM CSWANSON, PLOTTED: 6/12/2020 2:10 PM CHUCK SWANSON
 \\Eureka\Projects\2017\017062-ArcataLandCo\100-Leachfield\Drawgs\506-231-011\017062-100-DISPOSAL-DTLS.dwg

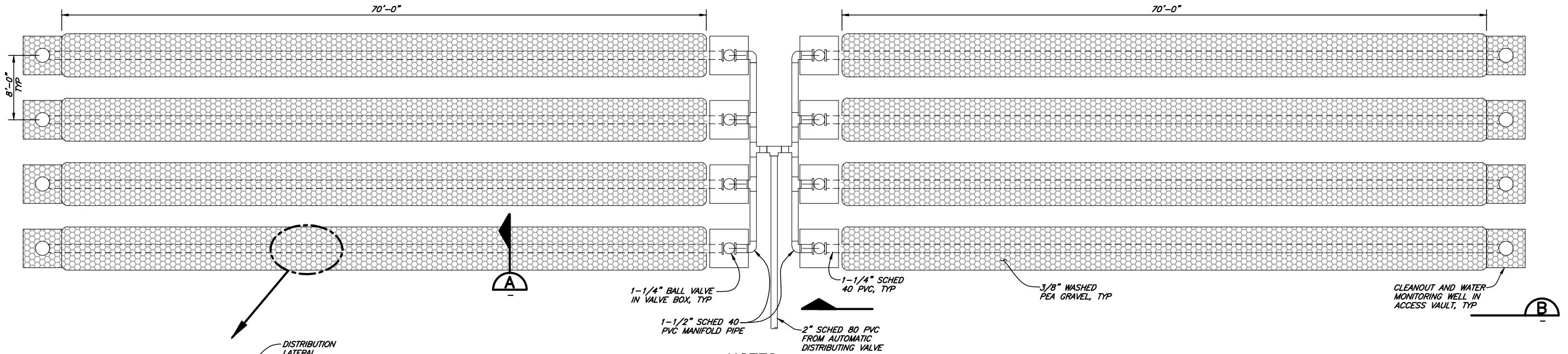

NOTES:
1. TYP OF 4.

DETAIL 1
NTS

(DISTRIBUTION SYSTEM LAYOUT)

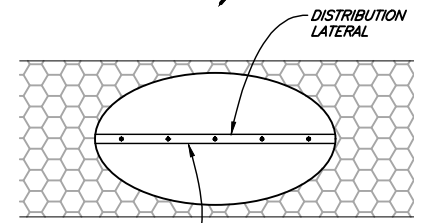

PIPE SIZE=1-1/4" SCHED 40 PVC
 ORIFICE SIZE=1/8"
 ORIFICE SPACING=60"
 BEGIN AND END ORIFICE PLACEMENT
 2.5' FROM ENDS OF LATERAL

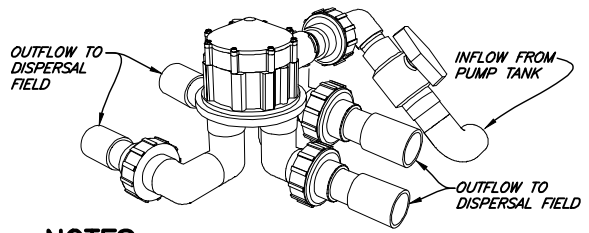

NOTES:
HYDROTEK VALVE, MODEL #V6404A, BY ORENCO SYSTEMS, LLC.

DETAIL 2
NTS C-1

(AUTOMATIC DISTRIBUTING VALVE)

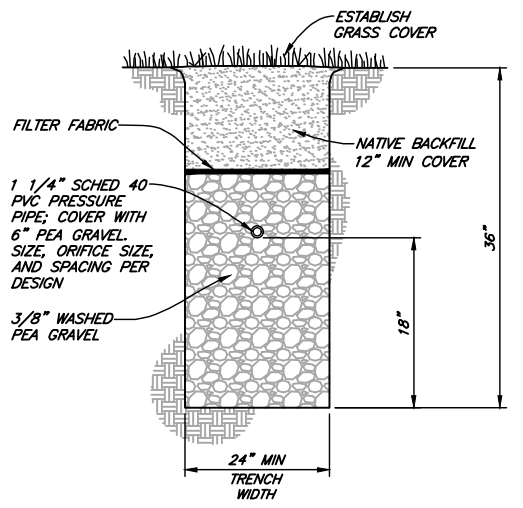

SECTION A
NTS

(TRENCH SECTION)

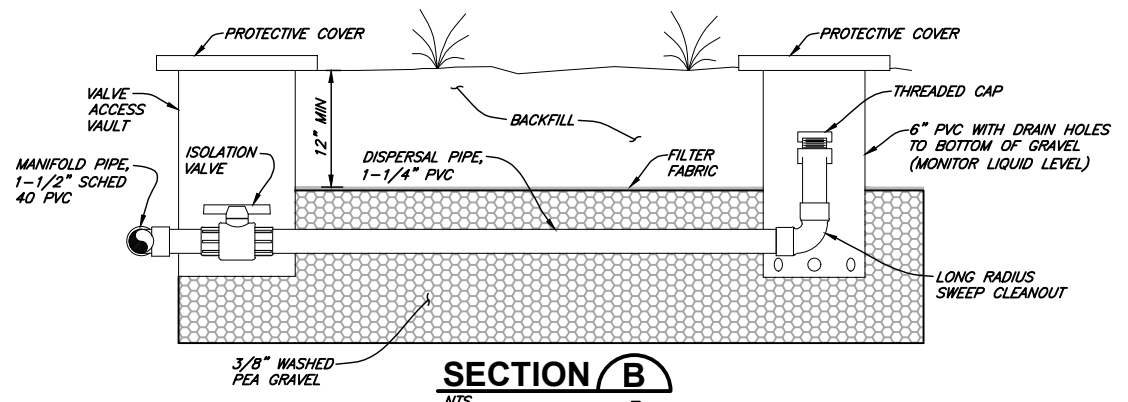

SECTION B
NTS

(LONGITUDINAL TRENCH SECTION)

VERIFY SCALES
 BAR IS ONE INCH ON ORIGINAL DRAWING
 O IF NOT ONE INCH ON THESE SCALES ACCORDINGLY

812 W. WABASH AVE.
 FULLERTON, CA 92601
 WWW.S&W-ENR.COM
 707-441-8855



NO.	DATE	REVISION	BY

DESIGN	GAY
DR	CRS
CHK	GAY
APVD	

ARCATO LAND COMPANY, LLC
 ONSITE WASTEWATER TREATMENT AND DISPOSAL SYSTEM
 ARCATO, CALIFORNIA

DISPOSAL FIELD DETAILS

SHEET	C-4
SEQ	6
DATE	06/2020
PROJ. NO.	017062.100



May 19, 2020

David Holmes
E-mail: david.holmes@shawcor.com

CC: Bill Robbins

Re: One 8-foot-diameter 12,000-gallon Single-Wall Tank
Buoyancy Calc – Arcata Land Co

Dear David:

We have summarized the buoyancy data you requested. All of the calculations are based on the site data you have provided to us and on nominal engineering values for the physical parameters.

All of the calculations are based on standard engineering practice. We use approaches in a manner similar to the protocols presented in the PEI/RP 100-17 manual to calculate the underground tank Buoyancy Safety Factors.

It is the tank owner's responsibility to determine the suitability and applicability of installation. Our sole responsibility in any installation is as stated in our Limited Warranty.

Our calculations show that, given the installation parameters that you have provided to us (calculated with the tank empty, the water table at the same elevation as the top of the tank, burial depth of 3 feet, and using factory-supplied deadmen) the Buoyancy Safety Factor is **1.73:1**. We recommend a minimum Buoyancy Safety Factor of 1.20:1. I have included a copy of the worksheet for your files.

If we can be of additional assistance, please feel free to contact us.

Sincerely,

Jeffrey Lexvold
Sales Support Manager

Attachment

7901 Xerxes Avenue South • Minneapolis • Minnesota • United States • 55431-1288
Ph: 952-887-1890 • Fax: 952-887-1870 • Web: www.zcl.com

XERXES CORPORATION		DEADMAN BURIAL WATER AT TANK TOP	Arcata Land Co	05/19/20
TANK DATA		INSTALLATION		
NOM. CAP. (GAL.)	12000	TOTAL COVER INCLUDING SOIL & TOP SLAB (FT)		
TYPE (SINGLEWALL=1;DW=3)	1	TOP SLAB THICKNESS (IN)		
DRY=1; WET=2	1	TOP SLAB LENGTH (FT)		
NOM. TANK DIA. (FT.)	8	TOP SLAB WIDTH (FT)		
*****		DEADMAN LNG (FT)		
PROD. STORED (GAL)	0	DEADMAN WID (IN)		
SPEC. GRAV. USED	1.00	DEADMAN THK (IN)		
		# OF 30" DIAMETER RISERS		
DOWN FORCE/UP FORCE =		1.73 :1		
		TOTAL WEIGHTS		
DOWN FORCES		CONCRETE WEIGHT 6336.00 LBS.		
		BACKFILL WEIGHT 162729.82 LBS.		
		TANK WEIGHT 5100.00 LBS.		
		PRODUCT WEIGHT 0.00 LBS.		
		TOTAL DOWN FORCE---- 174165.82 LBS.		
UP FORCES		TANK DISP. FORCE 100924.32 LBS.		
		TOTAL UP FORCE---- 100924.32 LBS.		
		WORKSHEET		
		TANK DATA		
SHELL DIAMETER-----	7.67 FT.	* ACTUAL CAP (GAL)	11682.00	
SHELL LENGTH-----	29.38 FT.	* TANK WT. (LBS.)	5100.00	
DOME PROJECTION-----	3.83 FT.	* O.A.L. (FT.)	37.04	
MID POINT HEIGHT-----	6.83 FT.	* NUMBER OF RIBS	22.00	
COLUMN HEIGHT-----	10.67 FT.	* *****		
RIB VOLUME-----	2026.00 CU. IN.	DOME A. (SQ FT)	46.16	
		DOME VOL. (CU FT)	235.95	
		REINFORCED CONCRETE VOLUMES (CU. FT.)		
TOP SLAB-----	0.00	DEADMEN	72.00	
FORCE = VOL. X 150 LBS/CF	0.00	FORCE (LBS) = VOL. X 88 LBS/CF	6336.00	
TOP SLAB & DEADMEN FORCE		6336.00 LBS.		
		BACKFILL VOLUMES (CU. FT.)		
OVER TANK SHELL-----	631.45 DRY	185.27 WET		
OVER TANK DOMES-----	138.49 DRY	58.99 WET		
OVER DEADMEN-----	216.00 DRY	552.00 WET		
END WEDGE-----	99.69 DRY	106.53 WET		
SUBTOTAL VOL (CU. FT.)	1085.63 DRY	902.79 WET		
SUBTOTAL WTS (LBS.)	108562.57 DRY	54167.25 WET		
TOTAL BACKFILL WEIGHT		162729.82 LBS.		
		BUOYANCY		
SHELL VOLUME-----	1356.07 CUBIC FT.			
DOME VOLUME-----	235.95 CUBIC FT.			
RIB VOLUME-----	25.79 CUBIC FT.			
TOTAL VOLUME	1617.81 CUBIC FT.			
VOL X 7.48 GAL/CU.FT.	12101.24 GALLONS			
FORCE = GAL X 8.34 (LBS./GAL)		100924.32 LBS.		

SAVED: 6/12/2020 2:11 PM CSWANSON, PLOTTED: 6/12/2020 2:11 PM CHUCK SWANSON
 \\Eureka\Projects\2017\017062-ArcataLandCo\100-Leachfield\Draws\506-231-011\017062-100-BUOY-CALC.dwg

VERIFY SCALES
 1" = 1' IF NOT ONE INCH ON THIS SHEET, ADJUST SCALES ACCORDINGLY

812 W. WABASH AVE.
 EUREKA, CA 95501
 WWW.SHN-ENGR.COM
 707-441-8655



BY	
REVISION	
DATE	
NO.	

DSGN	GAV
DR	CRS
CHK	GAV
APVD	

ARCATA LAND COMPANY, LLC
 ONSITE WASTEWATER TREATMENT AND DISPOSAL SYSTEM
 ARCATA, CALIFORNIA
BUOYANCY-CALCS

SHEET	C-5
SEQ	7
DATE	06/2020
PROJ. NO.	017062.100