

EXHIBIT B

SECTION 6, TOWNSHIP 4 NORTH, RANGE 1 WEST
SECTIONS 15, 16, 20, 21, 29, 31, 32 TOWNSHIP 5 NORTH, RANGE 1 WEST
COUNTY OF HUMBOLDT, STATE OF CALIFORNIA



PREPARED BY OR UNDER SUPERVISION OF:

R. W. Bronkall 12/17/2021

ROBERT W. BRONKALL, PLS 7645
HUMBOLDT COUNTY SURVEYOR

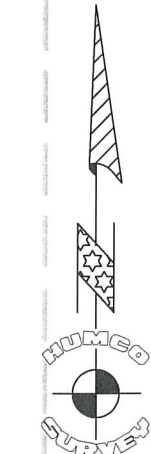
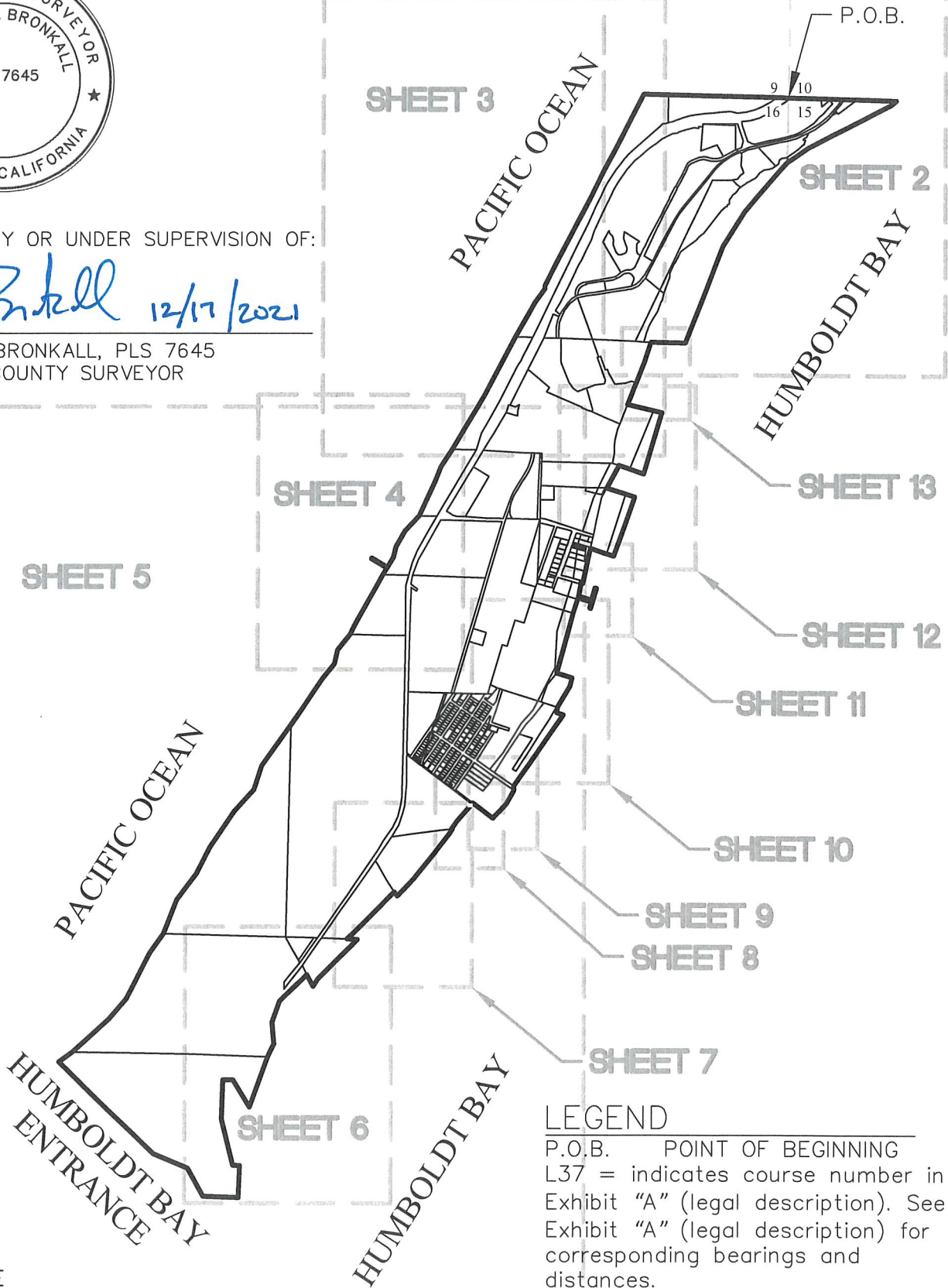

NOT TO SCALE

LEGEND
P.O.B. POINT OF BEGINNING
L37 = indicates course number in Exhibit "A" (legal description). See Exhibit "A" (legal description) for corresponding bearings and distances.

PACIFIC OCEAN

NORTH LINE
SECTION 16

P.O.B. NORTHEAST
CORNER SECTION 16

NORTH LINE
SECTION 15

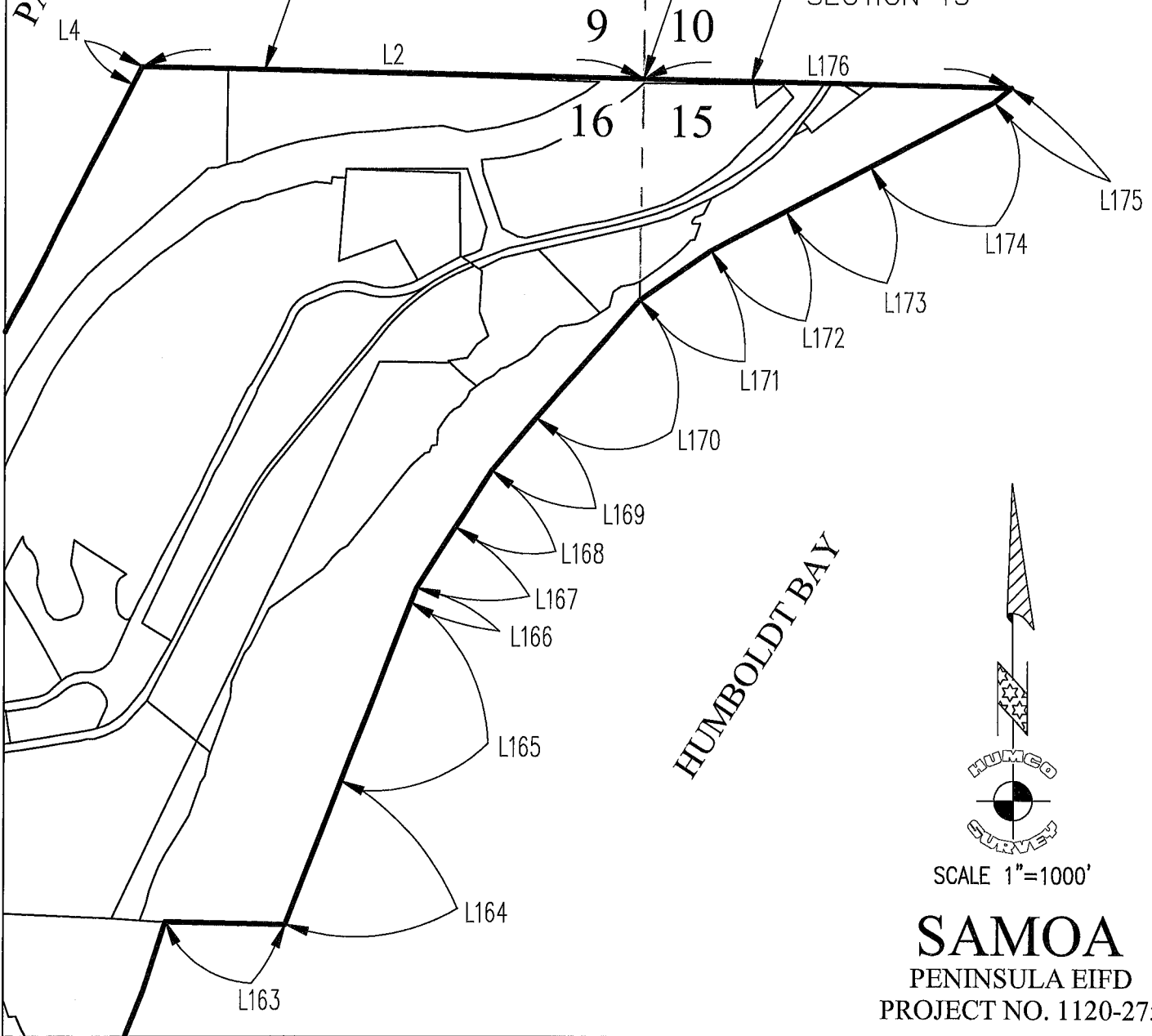

HUMBOLDT BAY

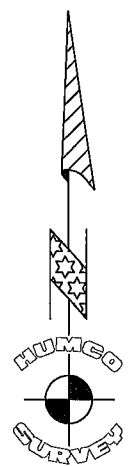

SCALE 1"=1000'

SAMOA
PENINSULA EIFD
PROJECT NO. 1120-275

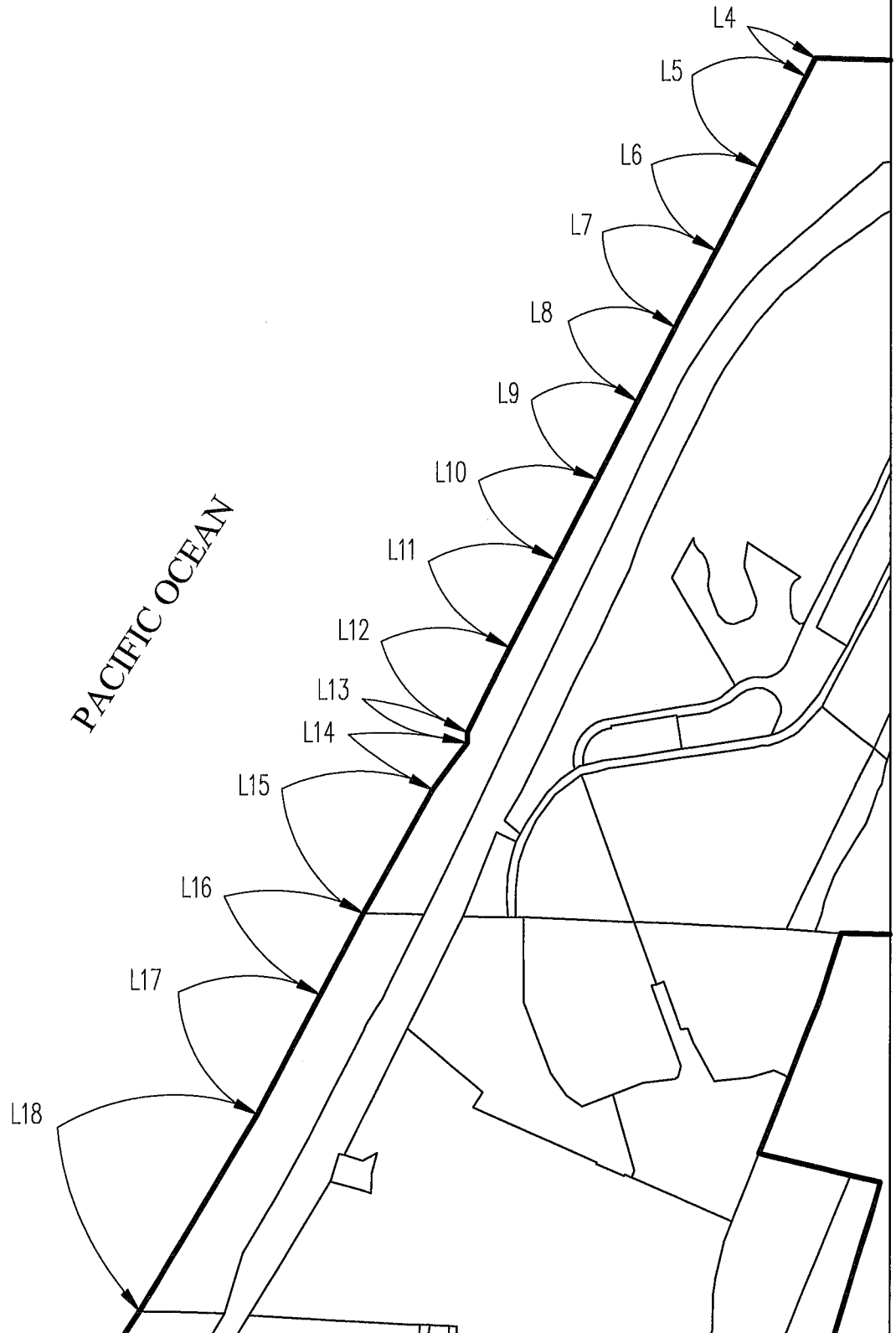
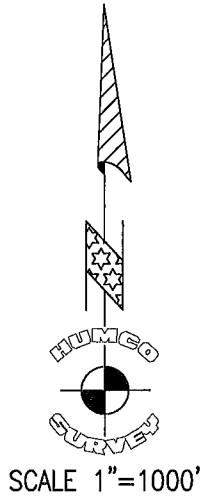

SAMOA
PENINSULA EIFD
PROJECT NO. 1120-275

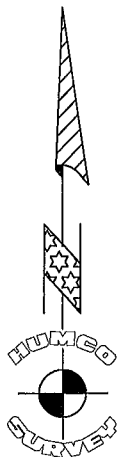

SCALE 1"=600'

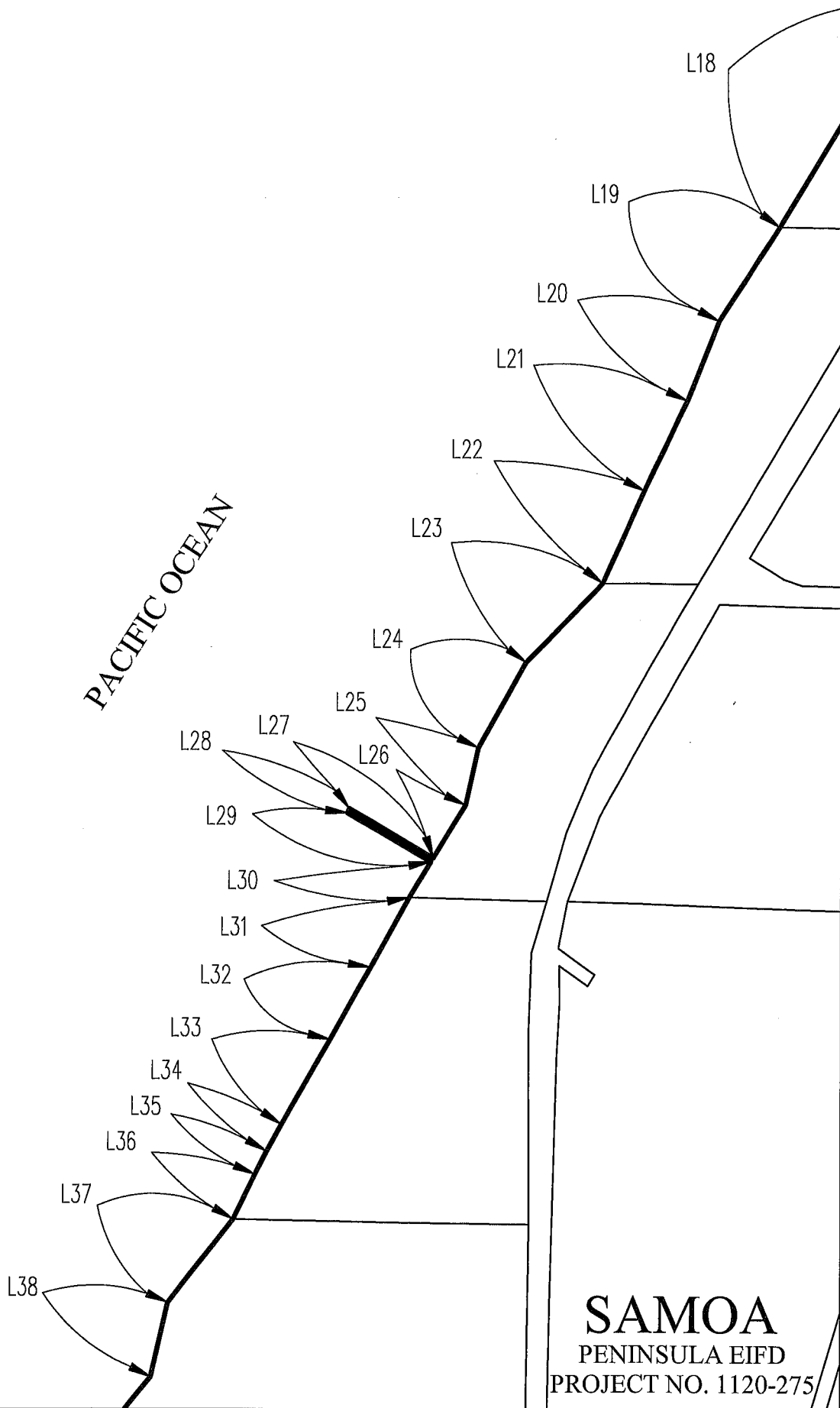

PACIFIC OCEAN

SAMOA
PENINSULA EIFD
PROJECT NO. 1120-275

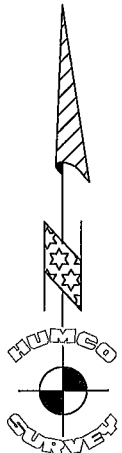

SCALE 1"=2000'

PACIFIC OCEAN

HUMBOLDT BAY ENTRANCE

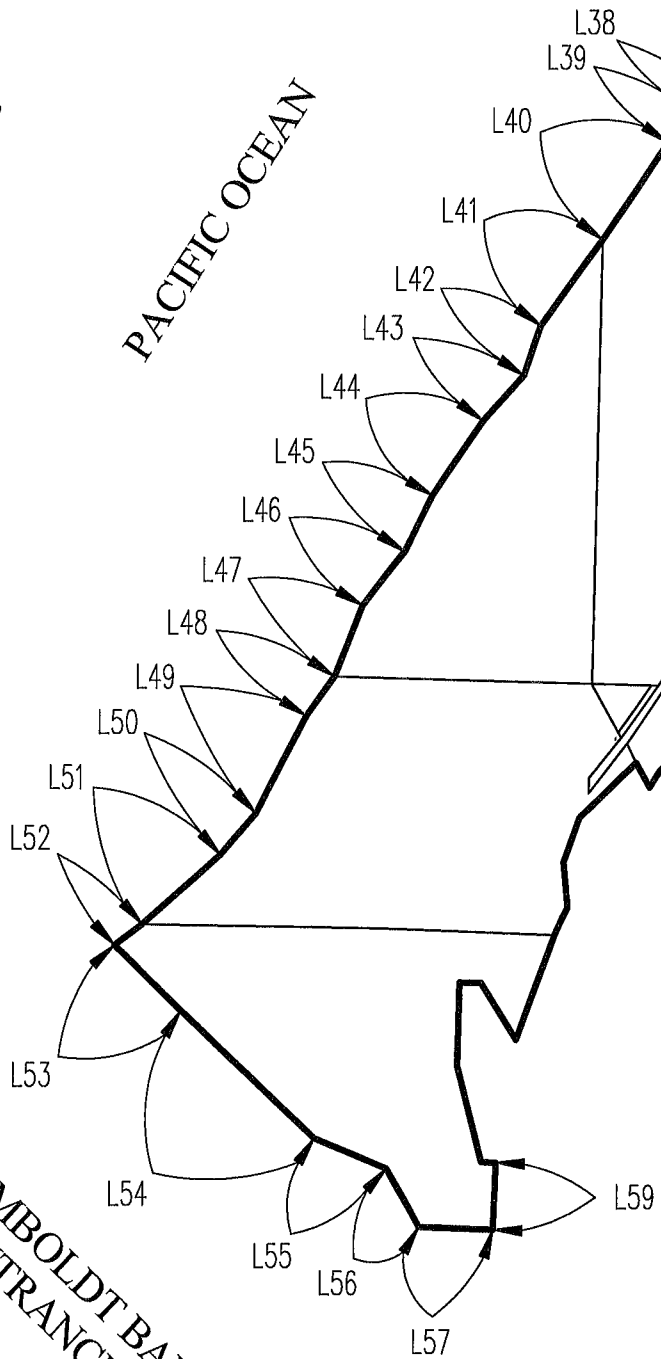

HUMBOLDT BAY

SAMOA
PENINSULA EIFD
PROJECT NO. 1120-275

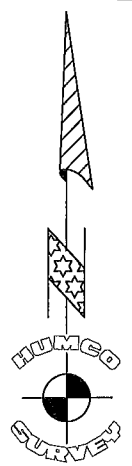

SCALE 1"=600'

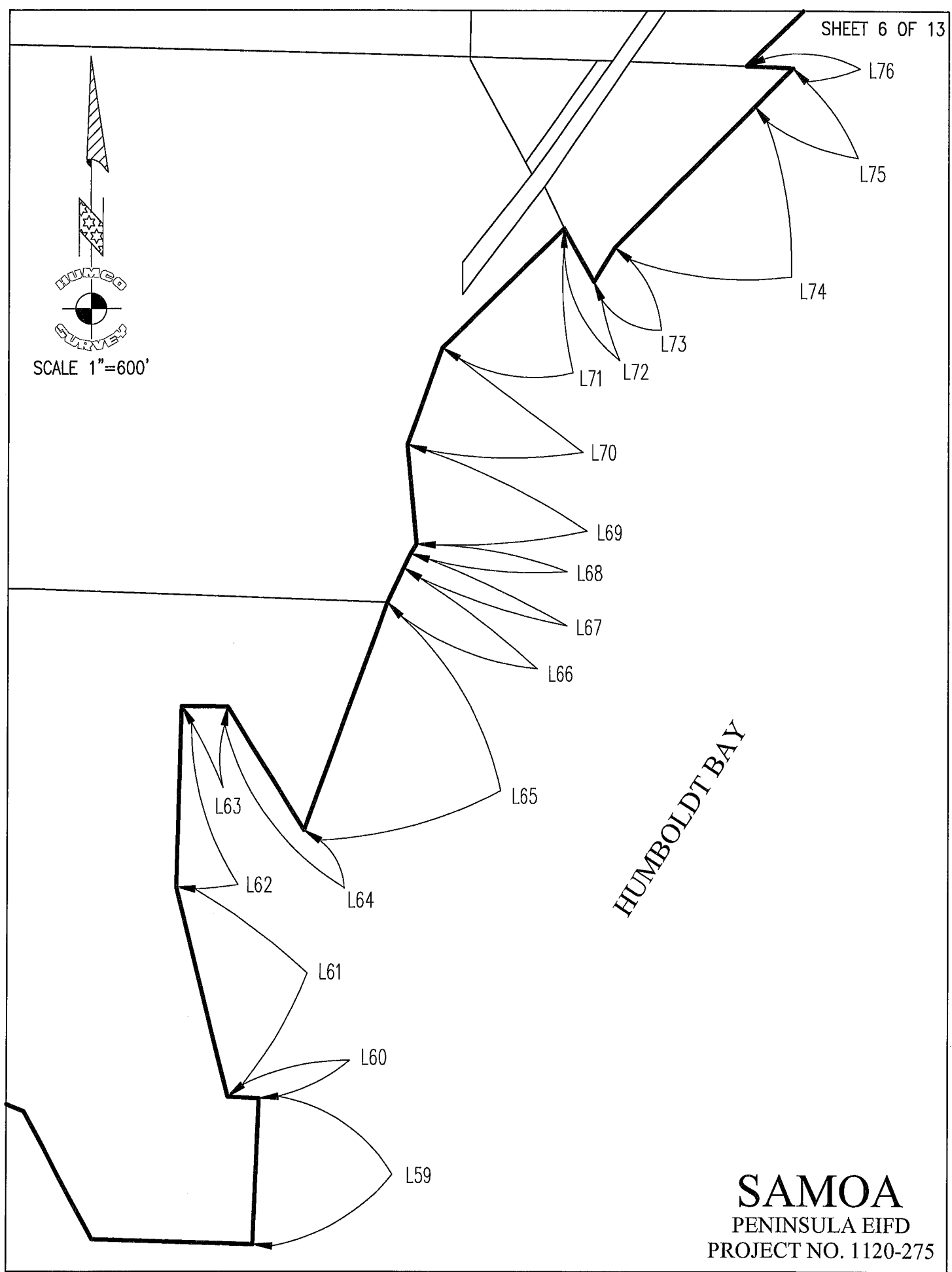

HUMBOLDT BAY

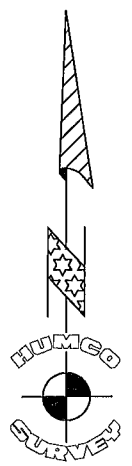

SCALE 1"=400'

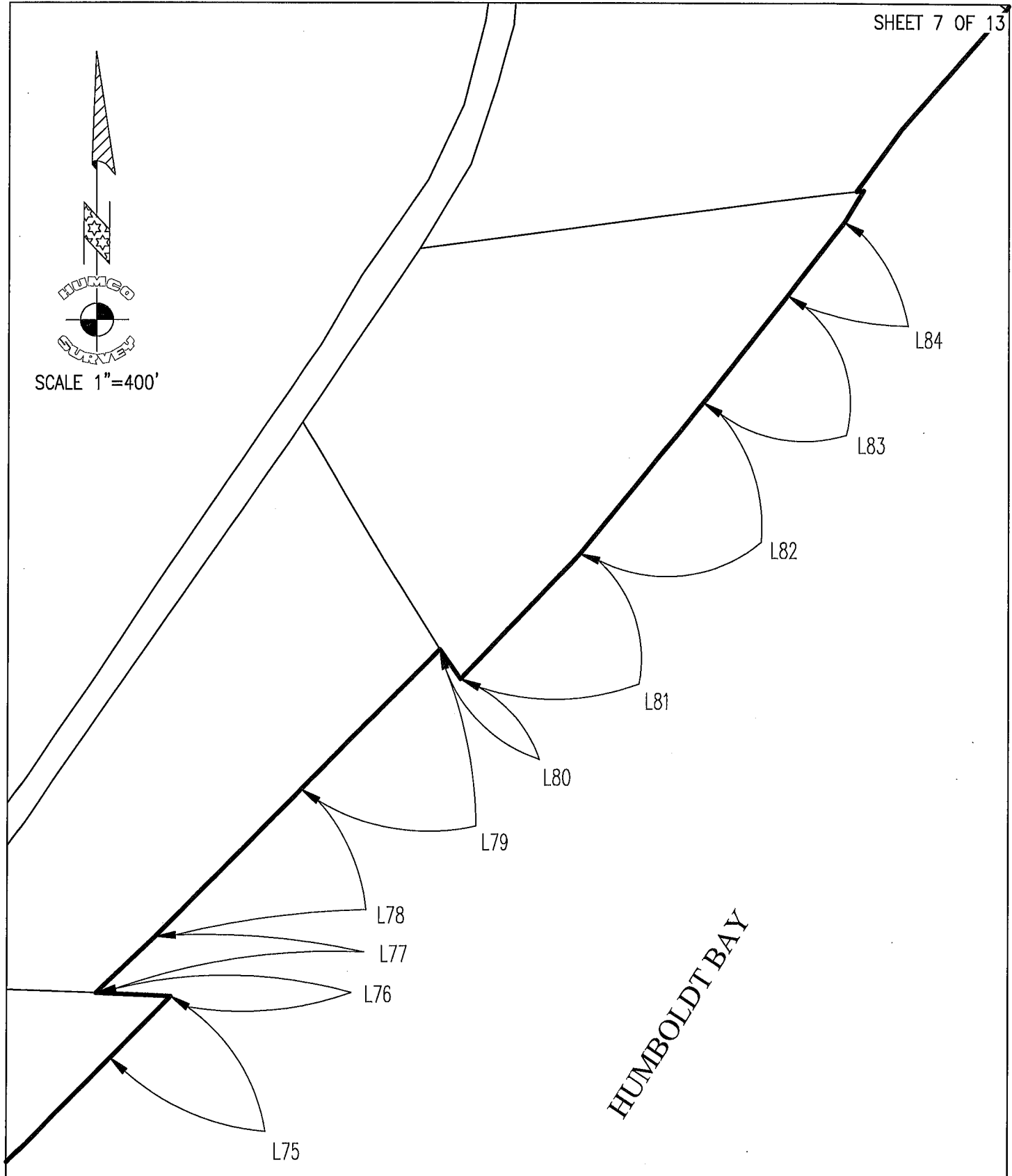

HUMBOLDT BAY

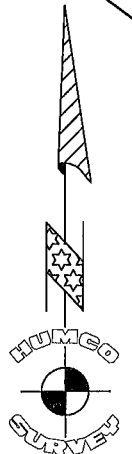

SCALE 1"=200'

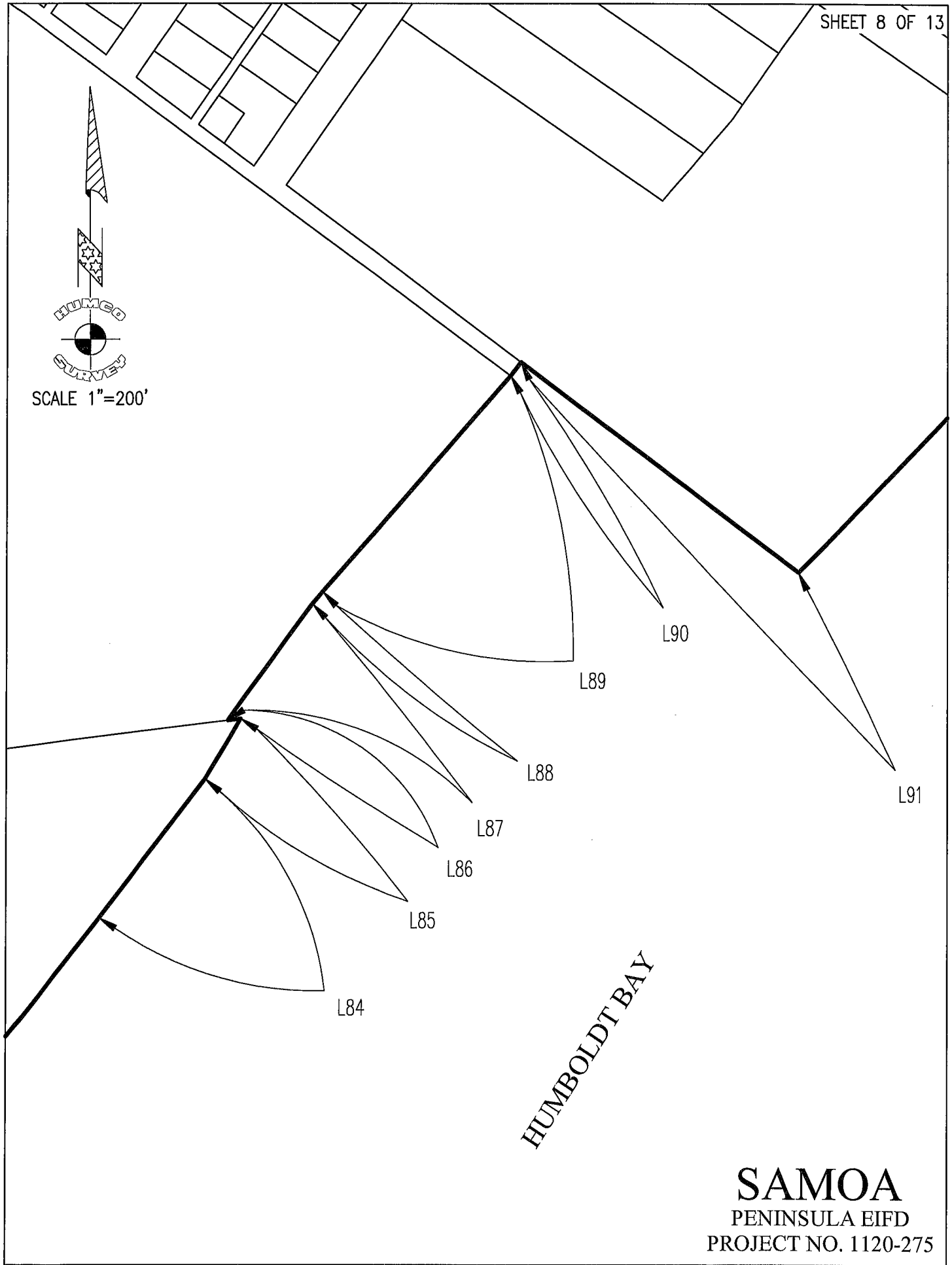

SAMOA
PENINSULA EIFD
PROJECT NO. 1120-275

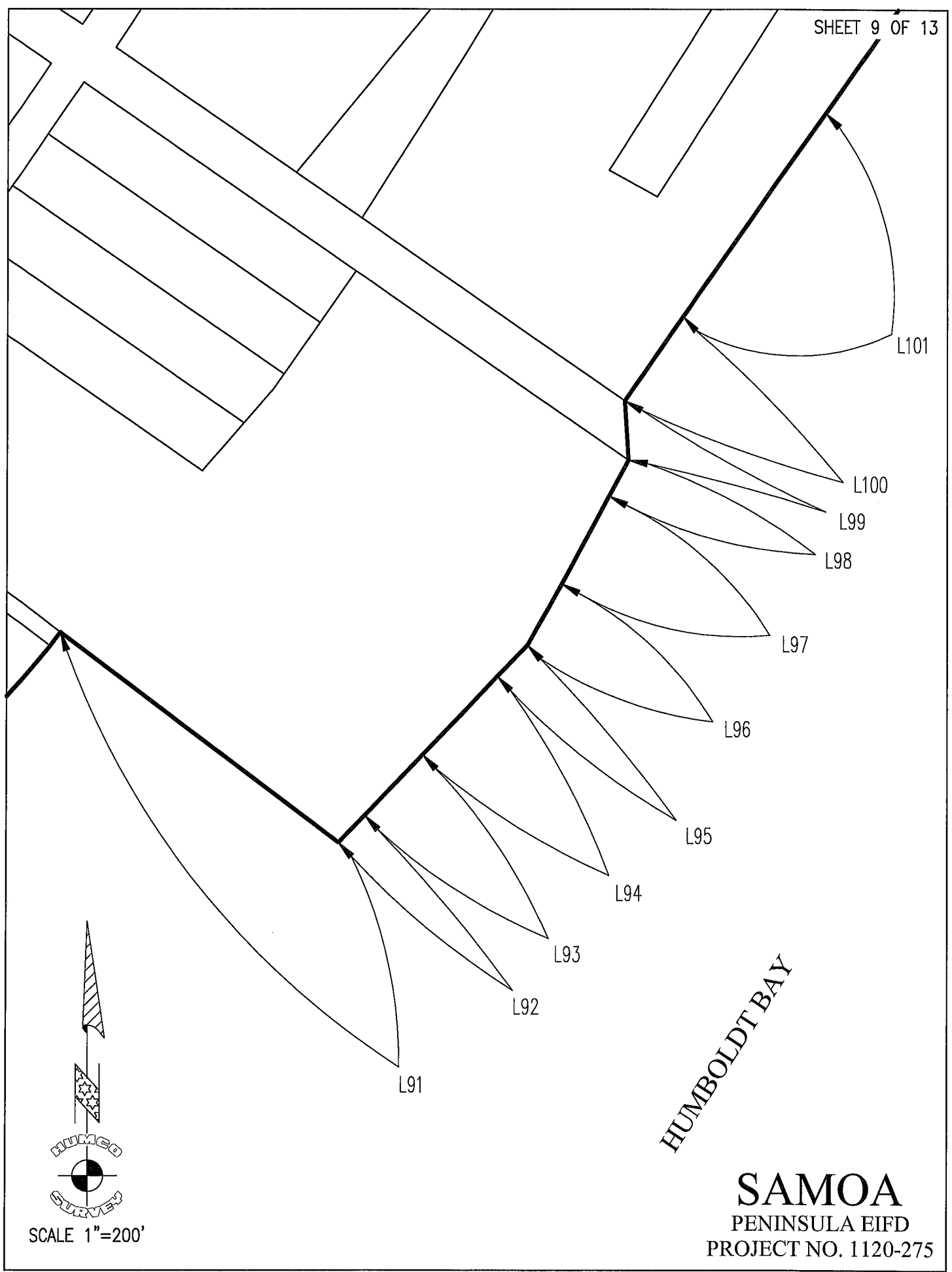

HUMBOLDT BAY

SAMOA
PENINSULA EIFD
PROJECT NO. 1120-275

HUMBOLDT
SURVEY

SCALE 1"=200'

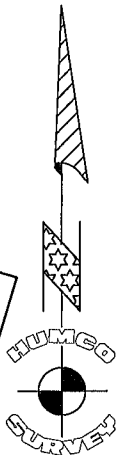

SCALE 1"=400'

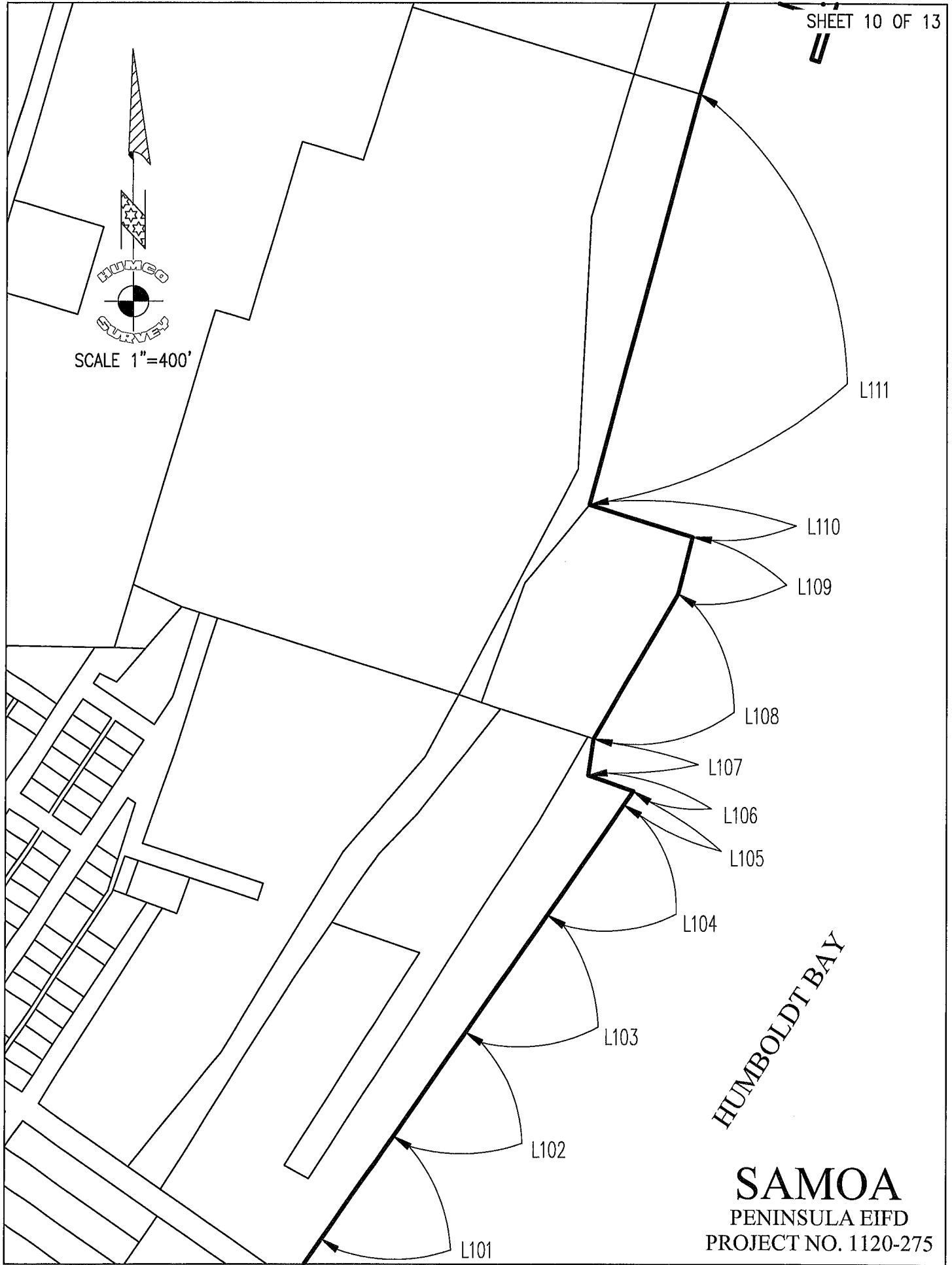

HUMBOLDT BAY

SAMOA
PENINSULA EIFD
PROJECT NO. 1120-275

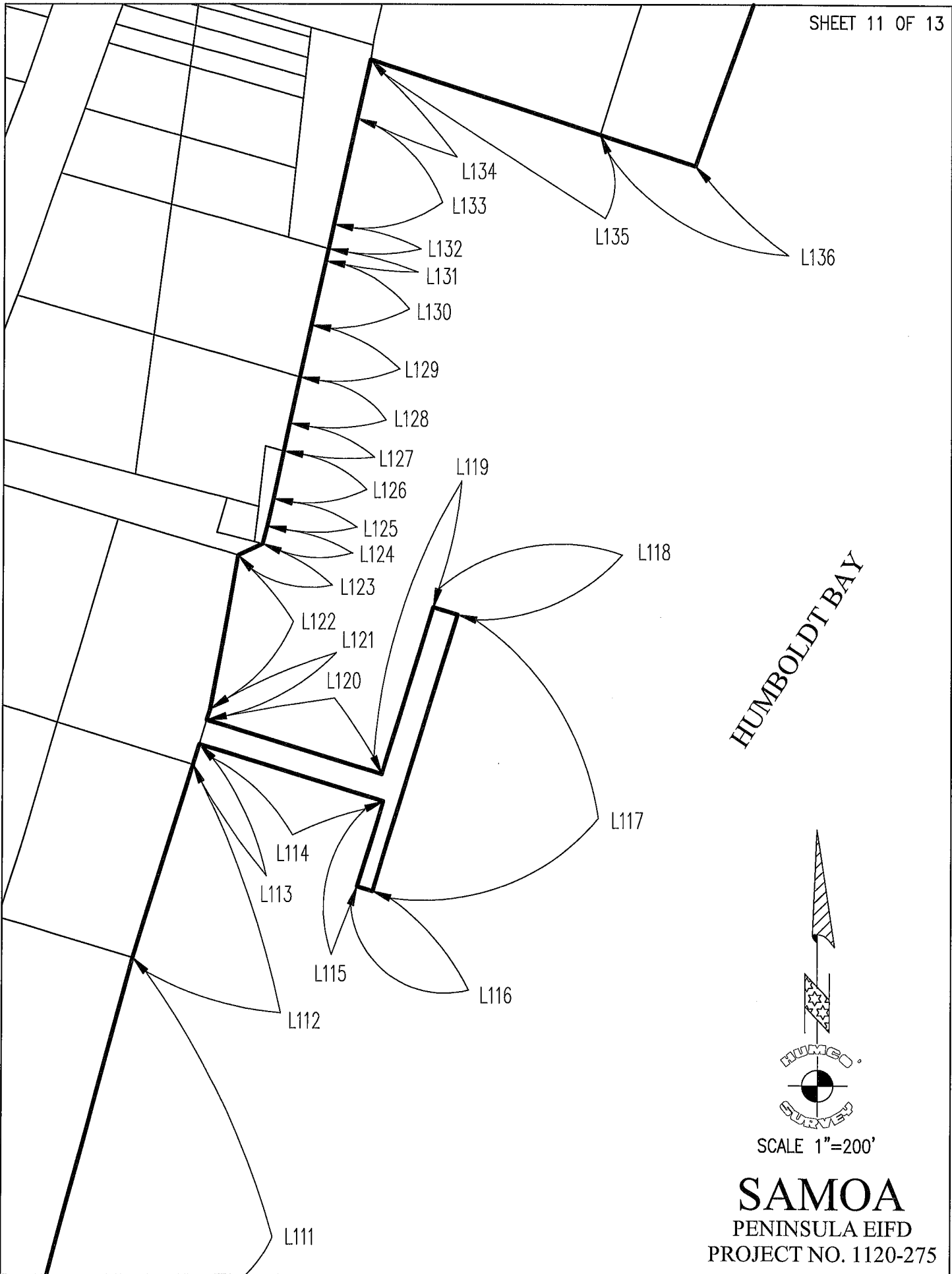

HUMBOLDT BAY

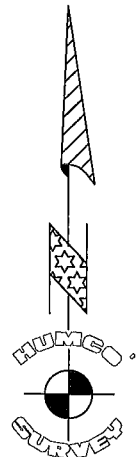

SCALE 1"=200'

SAMOA
PENINSULA EIFD
PROJECT NO. 1120-275

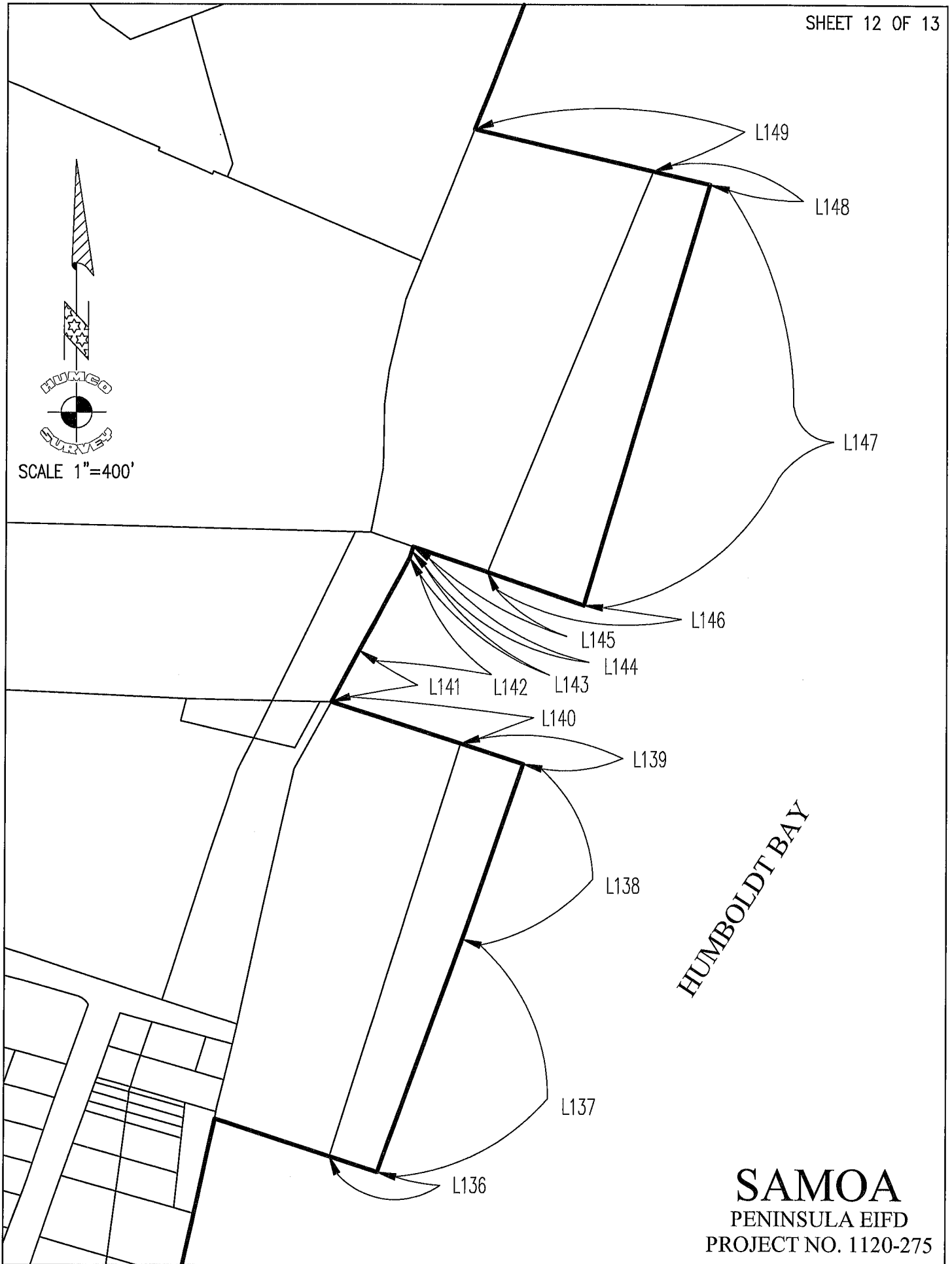

SCALE 1"=400'

HUMBOLDT BAY

SAMOA
PENINSULA EIFD
PROJECT NO. 1120-275

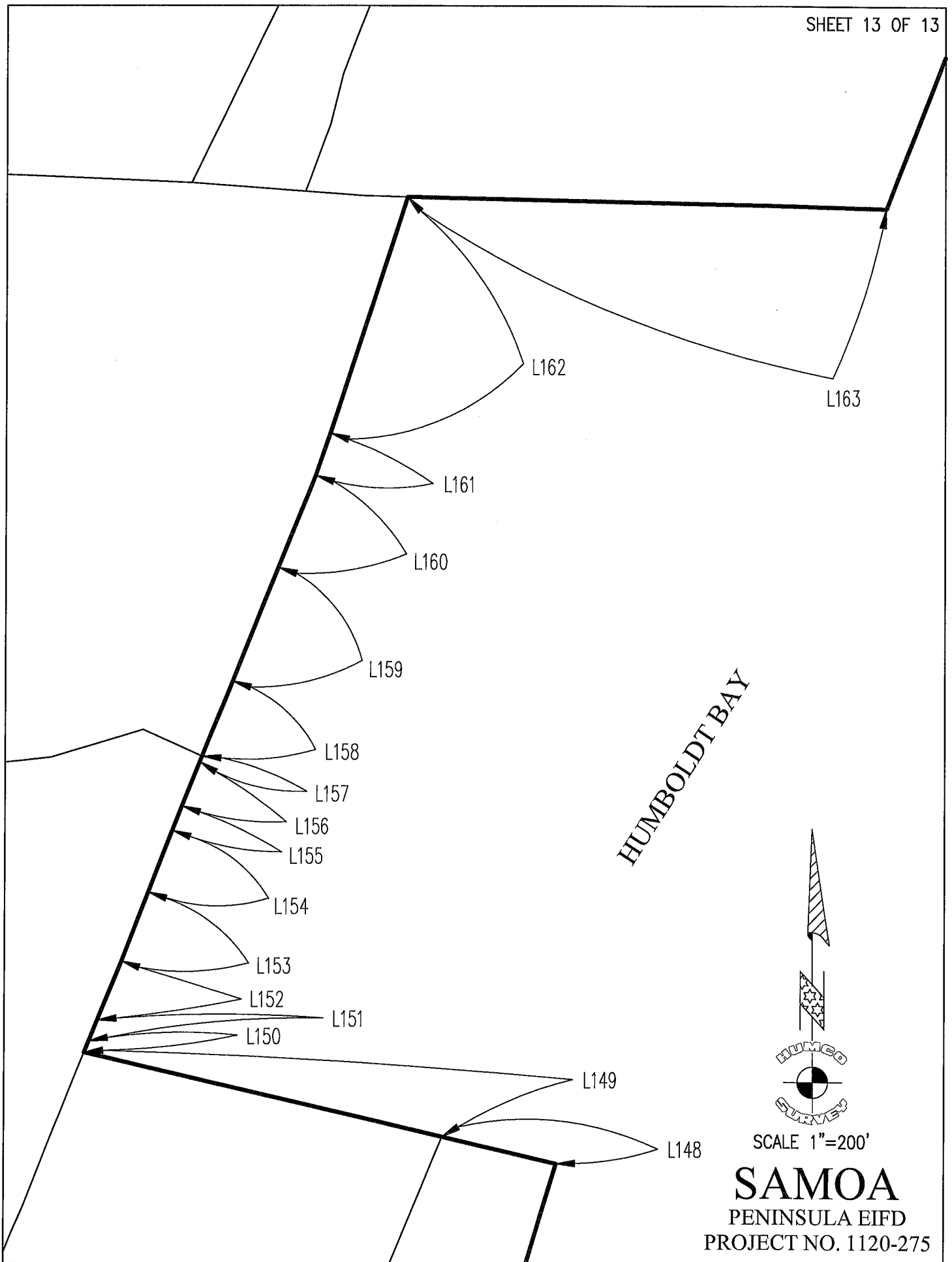

HUMBOLDT BAY

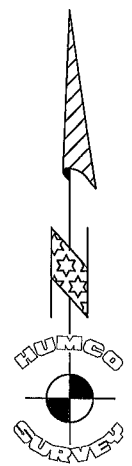

SCALE 1"=200'

SAMOA
PENINSULA EIFD
PROJECT NO. 1120-275