

## **SUPPLEMENTAL INFORMATION #2**

For the Board of Supervisors Agenda of  
March 17,2020

- Consent Agenda Item
- Continued Hearing Item
- Matters Set for Time Certain # K-2
- Public Hearing Item
- New Business

**Re: Redwood Properties' Appeal of the Planning Commission Approval of The Emerald Triangle Group, LLC Co's Special Permits to Allow Cannabis Distribution and Non-Volatile Manufacturing in the C-2(D) Zoning District**

Attached for the Board's record and review is (are) the following supplementary information item(s):

1. Letter from Joshua Allen project manager and planner for Emerald Triangle addressing concerns of the Appeal.
2. Public Comments in support of the project

To: Humboldt County Board of Supervisors  
825 5th Street  
Eureka, CA 95501

Date: March 1, 2020

From: Joshua Allen, MPA  
PO Box 272  
Fields Landing, CA 95537  
planittechs@gmail.com

Subject: Concerning the Appeal of PLN-12733-SP and PLN-12747-SP for APN 032-051-032 at 829 Redwood Drive, Garberville

Your Honors,

Please accept these comments concerning the appeal of PLN-12733-SP and PLN-12747-SP for APN 032-051-032 at 829 Redwood Drive, Garberville. I am the planner and project manager for the applicant, Emerald Triangle Group, and these are my professional comments concerning the appeal. In general, I highly disagree with the appeal letter dated December 18, 2018 by Allison Jackson on behalf of her client Craig Lehman the owner of Redwood Properties adjacent to the project, and agree with both County Staff and the Planning Commission determination that this project is exempt from California Environmental Quality Act (CEQA) with "No Significant Environmental Impact". Further, my professional opinion is that the appeal and the commenters are based upon un-factual and emotional not in my backyard syndrome, otherwise known as NIMBYism.

The project is question is the reuse of a Community Commercial Zoned with Design Control (C-2-D) building in downtown Garberville which is owned and mostly used by the applicant (Figure 1). This building is an old three-story multiuse mercantile store built in 1895. In the back is a dilapidated concrete structure not historical in nature which originally was used to manufacture ice (Figure 2) and a metal two-story mini-storage. During the last one hundred thirty years (130yr) the uses for the building have gone through many different mixed uses and the County Tax Assessor does not track business licenses prior to 2000.

The building frontage has three (3) separate entrances. On the ground floor are two (2) to commercial spaces with front and back street access, which have been vacated and unused by previous tenants for years, and are the location of the proposed cannabis distribution and Type 6 hash/press manufacturing facilities. A middle street entry to the second story with office spaces rented to a couple small business which there is no intent of removing. In the backyard, isolated and not touching any building, is the ice house which is proposed to be a small Type 6 ethanol extraction laboratory. Also, within the backyard is a stairwell which leads to the third-floor owner's incidental caretaker residence, and the mini-storage abutting the alley (Figure 3).

**Figure 1: Frontage of 829 Redwood Drive, Garberville**



**Figure 2: Old 12'x16' Two-Story Ice House to be Replaced with 12'x16' One-Story Modern Ethanol Lab in Same Footprint**

Over time the concept of manufacturing has changed, with the original intent of the ice house to provide a needed product to the community, and until now most uses on the property were unregulated. In the past building was used to manufactured ice for fridge boxes using machinery filled with ammonia. It's impossible to know what else has been manufactured in the building's footprint in the past, though the proposed use is consistent with light commercial manufacturing of goods, and therefore best to use Black's Law Dictionary of "manufacture":

1. "The primary meaning of this word is "making with the hand," but this definition is too narrow for its present use. Its meaning has expanded as workmanship and art have advanced, so that now nearly all artificial products of human industry, nearly all such materials as have acquired changed conditions or new

and specific combinations, whether from the direct action of the human hand, from chemical processes devised and directed by human skill, or by the employment of machinery, are now commonly designated as “manufactured.” <https://thelawdictionary.org/manufacture/>



**Figure 3: Project Footprint**

The use of the entire building, including the ethanol laboratory, meets Humboldt County Code Title III Division 1 Chapter 4 Section 314.2.2 C-2 Zone as intended for principal and permitted uses. The building is proposed for projects which are business offices providing services of a light commercial character, conducted entirely within an enclosed building, with the owner's incidental residence, printing, and handicraft manufacture within the laboratory which will replace the footprint of the ice house. Replacing the ice house and then light manufacturing of goods is consistent with past use.

Further, this project was submitted in December 2016 under Ordinance No. 2559 Section 314-55.4 of Chapter 4 of Division 1 of Title III., otherwise known as Ordinance 1.0. The intent has been to achieve a building permit which requires a cannabis permit first and have been dealing with the changing nature of both local and state regulations. At that time of submission under Section 314-55.4.11 Performance Standards for setbacks on page 13 were only specific to cultivation and processing.

- I. 314-55.4.11(d) The area of cannabis cultivation and on-site processing shall be located as shown on the application site plan, set back at least 30 feet from any property line, and 600 feet from any School, School Bus Stop, Church or other Place of Religious Worship, Public Park, or Tribal Cultural Resources (as these terms are defined in section 55.2.6 and 55.4.7){...}

Ordinance 1.0 differentiated between processing and manufacturing facilities. Being specific and different facilities Section 314-55.4.11(d) does not apply. As defined within Code Section 314-55.4.7 Definitions on page 22:

- I. "Manufacturing Facility" means a process whereby the raw agricultural product is transformed into a concentrate, an edible product, or a topical product, and the production, preparation, propagation, or compounding of medical cannabis or medical cannabis products, directly or indirectly, by extraction methods, independently by means of chemical synthesis, or by a combination of extraction and chemical synthesis.
- II. "Processing Facility" means the location or facility where medical cannabis is dried, cured, graded, trimmed, and/or packaged by or under the control of one or more licensed cultivators, at a location separate from the cultivation site where the medical cannabis is grown and harvested.

When Ordinance No. 2599 amended Sections 314-55.4, 314-55.3.11.7, 314-55.3.7 and 314-55.3.15 of Chapter 4 of Division 1 of Title III of the County Code, otherwise known as Ordinance 2.0, it was implied and intended that Ordinance 1.0 standards still applied to distribution and manufacturing submitted prior to the December 31, 2016 deadline. Specifically, 314-55.4.3.1 Applicability and Interpretation was intended to protect the vested interests of business that applied under Ordinance 1.0 and adjusted to the changes in regulation as they sought not only a building permit, but also state licensing, both of which are dependent upon a cannabis permit, and Ms. Jackson has misinterpreted this section of code. The only operations intended by the Board of Supervisors to be updated to Ordinance 2.0 regulations was open air cultivation.

- I. 55.4.3.1 All facilities and activities involved in the commercial cultivation, processing, manufacturing, and distribution, testing, and sale of cannabis within the jurisdiction of the County of Humboldt outside of the Coastal Zone shall be controlled by the provisions of this Section, regardless of whether those activities existed or occurred prior to the adoption of this Section. Applications for Commercial Cannabis Activity land use permits filed on or before December 31, 2016 shall be governed by the regulations in effect at the time of their submittal, **except as follows and is otherwise prescribed herein. Zoning Clearance Certificate applications for Open Air Cultivation filed on or before December 31, 2016 shall be controlled by the provisions of section 55.4.6.7 of this Section.**

Granted the language is clumsy with incorrect usage of commas and periods as written by County Staff but it effectively does nothing to either application. The purpose and intent of the Supervisors was that Open Air Cultivation meet additional Provisions for Neighborhood Compatibility under Section 314-55.4.6.7 for an Open Air Cultivation

Zoning Clearance Certificate for submitted under prior to Ordinance 2.0. Explicit Community Planning Areas were named including Blue Lake, Fieldbrook-Glendale, Fortuna, Hydesville-Carlotta, McKinleyville, Rio Dell-Scotia, Shelter Cove, Trinidad-Westhaven, and Willow Creek (pg. 22). Garberville is not listed, nor are the applications submitted for Open Air Cultivation, and therefore these projects are exempt from Ordinance 2.0 requirements for manufacturing or distribution.

Ms. Jackson incorrectly states that the projects are an environmental impact under CEQA requiring an Environmental Impact Report (EIR). My professional opinion is that County Staff and the Planning Commission correctly determined the projects Categorical Exempt after a public hearing and the Board of Supervisors should support these findings. Additionally, CEQA §15302 Class 2 Exemption applies for the replacement of the old ice house with a modern structure consistent with past use of the creation of small manufacturing of commercial goods using equipment that contains regulated hazardous materials. Specifically, CEQA Chapter 3 Article 19 §15302 Categorical Exemption should be applied as follows:

I. Replacement structure within same footprint with a fire safe light commercial manufacturing meeting all public health and safety codes.

A. §15302 Class 2: Replacement or Reconstruction consists of replacement or reconstruction of existing structures and facilities where the new structure will be located on the same site as the structure replaced and will have substantially the same purpose and capacity as the structure replaced, including but not limited to:

1. (b) Replacement of a commercial structure with a new structure of substantially the same size, purpose, and capacity.

Both projects are within the same footprint of the current structures. The use of the structures would be business offices, light commercial manufacturing, and storage of commercial products. Uppers floors of the building are separate from the project, under control of the applicant as the owner, and current uses would be maintained. The baseline of property is it's in disrepair from age and requires alteration or replacement for proposed uses allowed under Code and State Law to operate for commercial uses while meeting current public health and safety standards. Overall, the projects will not only rehabilitate the property, but also provide economic opportunities for the area, and are consistent with the past use of the building.

Complaints about the project are NIMBYism at best and do not meet the significance of impact requiring a CEQA EIR. Unfortunately for the appellant, CEQA addresses only environmental impacts, not social or economic impacts, which are only relevant to the extent they cause an issue such as blight. The project shall not create blight as the project building permit application is being adapted to maintain a storefront appearance and opportunity for cannabis tourism while being a secure safe facility after receiving public comment. The building has not been used for retail for years due to Garberville experiencing long-term economic decline, these projects would bring about a much-needed service facilities for local farmers, create twelve livable wage jobs with a

half million-dollar payroll, and generate tax revenue for the County and State. The local community impact to the project is not significant due to the rehabilitation and beneficial use of the property.

Impacts from the small ethanol extraction laboratory are also unfound and based upon unfamiliarity with the science of the project. The small extraction lab will be located within a new building upon the footprint of the old ice manufacturing house. There are not any environmental impacts due to the following:

- I. The original use of the structure was light commercial manufacturing in nature and has been used to support uses upon the property since 1895.
- II. The current building and proposed enclosed replacement structure are not attached to any other building with approximately six feet (6') between it and Humboldt Brand Business Solutions at APN 032-051-008.
- III. The replacement structure shall meet, if not exceed, all current fire, building, health, and safety standards for a non-volatile extraction laboratory.
- IV. Ethyl alcohol (ethanol) is classified as a non-volatile flammable liquid substance at room temperature that does not readily evaporate into a gas at normal conditions.
- V. Ethanol has a flash point of fifty-seven-degrees Fahrenheit (57°F) when it begins to slowly vaporize into the air. Higher temperatures increase the rate of vaporization and has a boiling point when it becomes a gas of one hundred seventy-three degrees Fahrenheit (173°F) (Figure 4).
- VI. Ethanol has a potential explosion limit between three and three tenths percent to eighteen percent (3.3%-18%) per volume of air when vaporized and requires a direct ignition source such as a spark or open flame. At those levels of vaporization, a person would become instantly drunk and aware there was an issue.

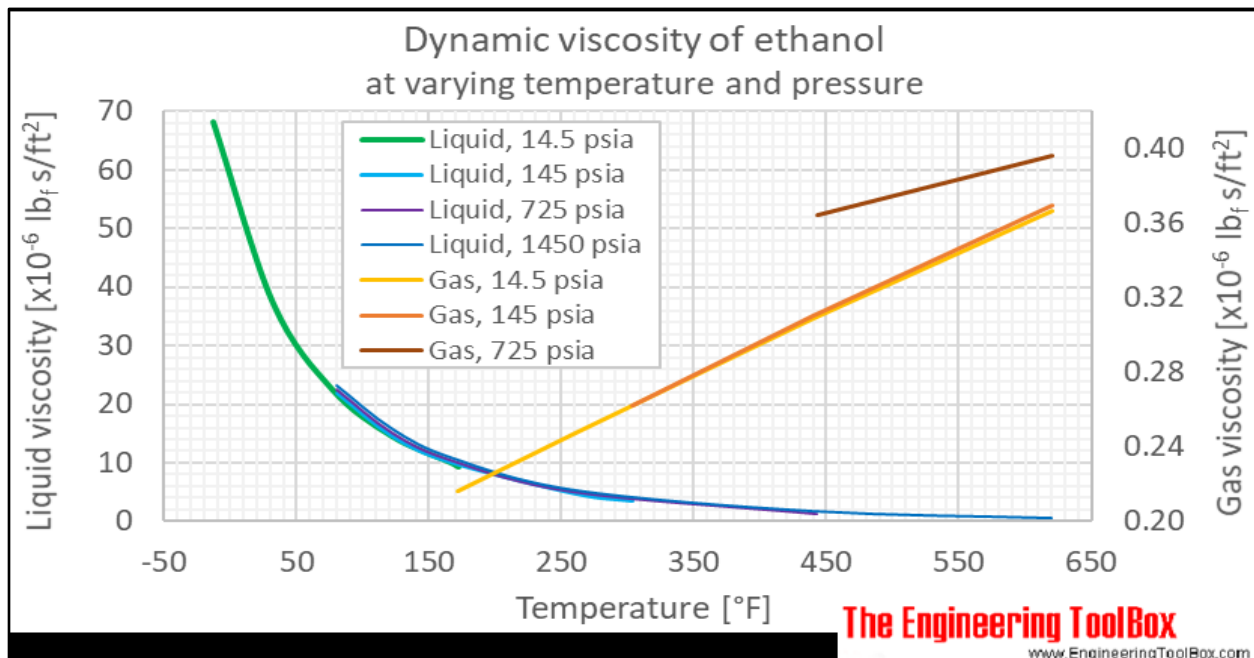

**Figure 4: Ethanol Temperature and Pressure Properties**

- VII. Ethanol has an autoignition temperature of six hundred eighty-five degrees Fahrenheit (685°F).
- VIII. Three-hour (3hr) fire separation walls shall be installed within the replacement structure.
- IX. Class A fire rated metal roof with a minimum of one-hour (1hr) fire separation shall be installed.

X. Minimum of two (2) UL Listed - \*Ceasefire CFP 1100 Low Profile Dry Chemical Fire Suppression System Units shall be installed (Figure 5).



**Figure 5: Ceasefire CFP 1100**

- XI. Ethanol shall be stored in the amount of one hundred twenty gallons (120gal) or less within sealed labeled containers and kept within UL Listed sixteen-gauge (16ga) steel fire cabinet(s) at all times when not in use.
- XII. An ENMET EX-5120 explosion proof sensor/transmitter with a NDIR sensor, or equivalent system, shall be installed to monitor air levels with alarms to trigger a ventilation system.
- XIII. An engineered ventilation hood with odor removal system shall be installed and connected to the air sensor system within the lab structure.
- XIV. A Hazardous Materials Business Plan meeting California Health & Safety Code, Division 20, Chapter 6.95 shall be submitted with the building permit application.
- XV. A copy of the Hazardous Materials Business Plan with a spill cleanup kit shall be kept on site at all times and qualified lab staff trained in its implementation.

XVI. Ethanol is an expensive resource which can be recaptured and reused continuously to reduce business expenses, deliveries, and storage amount.

XVII. The machinery for the ethanol extraction of cannabis crude is nothing more than a glorified UL listed stainless steel sealed and self-contained washing machine which holds twenty-five to thirty gallons (25-30gal) of ethanol at temperatures averaging minus forty degrees Fahrenheit (-40°F) (Figure 6).



**Figure 6: Ethanol Extraction Unit**

XVIII. The extraction unit and associated equipment have an ethanol recapture efficiency rate of ninety-seven percent (97%) which is kept and reused within the system.

XIX. Other equipment, such as the UL listed Rick Simpson Oil machine, vacuum oven, and five-gallon (5gal) rotovap also recapture ethanol, shall be installed under the ventilation hood system, and be certified by a licensed engineer to meet all current health and safety codes.



- XX. Within the Type 6 Hash/Press Manufacturing Frontage there shall be not ethanol storage or extraction machinery utilized. All equipment used within this facility shall be small mechanical in nature to extract additional raw products such as UL listed hydraulic press, water bubble hash filtration machine, steam vapor terpene distiller, joint rollers, and separator.
- XXI. Raw product made within the ethanol lab and hash/press facility shall either be assembled then packaged as a product on site, or, sold in bulk to another licensee such as a cannabis baker/packager/distributor to be produced into a secondary value-added Humboldt made product.

In terms of any setbacks from schools or bus stops (aka sensitive receptors) there are no applicable regulations under CEQA to keep the project from being permitted or licensed. Under Ordinance 1.0 there were no setback provisions for manufacturing or distribution from churches or schools, although, the assumption has always been that public schools always have a minimum six-hundred foot (600') setback. Ordinance 2.0 Section 55.4.6.4.4 setbacks from sensitive receptors are only required if either the school or bus stop were currently in use at the time of project application submittal. The Community Presbyterian Church and day care, as noted by the Pastor in his comment letter, has been burned down, was not in operation when the application was submitted, nor is currently in use.

Bureau of Cannabis Control (BCC) shall also undertake CEQA review for licensing. The only State setbacks are six hundred feet (600') from schools or licensed day care, with exceptions which apply to these projects. BCC shall refer to California Code of Regulations (CCR) Title 16 Division 42 §5026 regulations to determine an appropriate premise location. Specifically, they will determine the following under CEQA as to whether an exemption shall be issued:

- I. (a) A premises licensed under this division shall not be located within a 600-foot radius of a school providing instruction in kindergarten or any grades 1 through 12, day care center, or youth center that is in existence at the time the license is issued.
- II. (b) Notwithstanding subsection (a) of this section, if a local jurisdiction has issued a license or permit to conduct commercial cannabis activity at a premises that is located within a 600foot radius of a school providing instruction in kindergarten or any grades 1 through 12, day care center, or youth center, the Bureau may approve the premises for licensure if the following conditions are met:
  - A. (1) The applicant submits a copy of a valid license or permit from the local jurisdiction with the application for licensure; and
  - B. (2) The local jurisdiction notifies the Bureau that the applicant is in compliance with all applicable local ordinances and regulations pursuant to Business and Professions Code section 26055(g)(2)(C).

Clearly the regulations regarding potential affects the projects may have on the church's day care activities do not fall within the level of significance required for CEQA or denial of either the County permit or State license. Under Ordinance 1.0 there were no requirements to be setback from a sensitive receptor except public schools, and, if 2.0

were applied the permit meets approval due to timing of the project's application submittal. Further, due to the County permit and fact that the church with day care are closed means that the BCC shall issue a CEQA exemption under §5026(a)(b) in order to release licensing. Therefore, the issue of the day care does not reach a level of significance under CEQA to justify an EIR.

Another concern brought up by the appeal is the issue of the use of the hours of operation, alley, parking, deliveries, and emergency vehicle access for the site (Figure 7).

I. Hours of Operation

A. The facility is not going to be running twenty-four hours per day, instead, the following is proposed to occur:

1. Main business hours during harvest peaks would be from 8am to 12pm and consist of two (2) shifts.
  - a. Morning shift: 8am to 4pm.
  - b. Evening 4pm to 12pm.
2. Incoming and outgoing deliveries may occur after business hours during the early morning hours for delivery traffic and logistic purposes to provide goods to licensed dispensaries outside of Humboldt County.

II. Alley

- A. A public right of way which is County maintained.
- B. Accessed from Maple Lane a County maintained road.
- C. Approximately one hundred seventy-five feet (175') long.
- D. The public right of way ends behind the project site at APN 032-051-056 (Redwood Properties) owned by Lehman. Though, it is unknown if there is deeded access through Lehman's property to Redwood Drive.
- E. A gate located upon Lehman's property blocks circulation to Redwood Drive via the driveway shared by Getti Up Coffee and Johnston's Motel.
- F. There are future development plans on file with the building department for APN 032-051-020 to build a mixed-used development using the alley as access for a large parking lot without circulation through to Locust Street (Figure 8 & 9). This project has been plotted in Figure 7 to scale for reference.

III. Parking

- A. The project site is a well-established mixed-use commercial area that was developed prior to current code requirements and is therefore grandfathered under the code it was developed.
- B. There are sufficient spots according to an engineered report to meet the project needs.
- C. The majority of parking is located Redwood Drive and Maple Lane upon public County maintained streets.
- D. An ADA access parking and additional spots are rented at the Hemp Connection.
- E. After further investigation it appears that there are three (3) nine feet by eighteen feet spaces upon the property adjacent to the alley. These spaces have been plotted in Figure 7 to scale for reference.



F. Figure 7: Project Site General Area

Parking & Site Maps

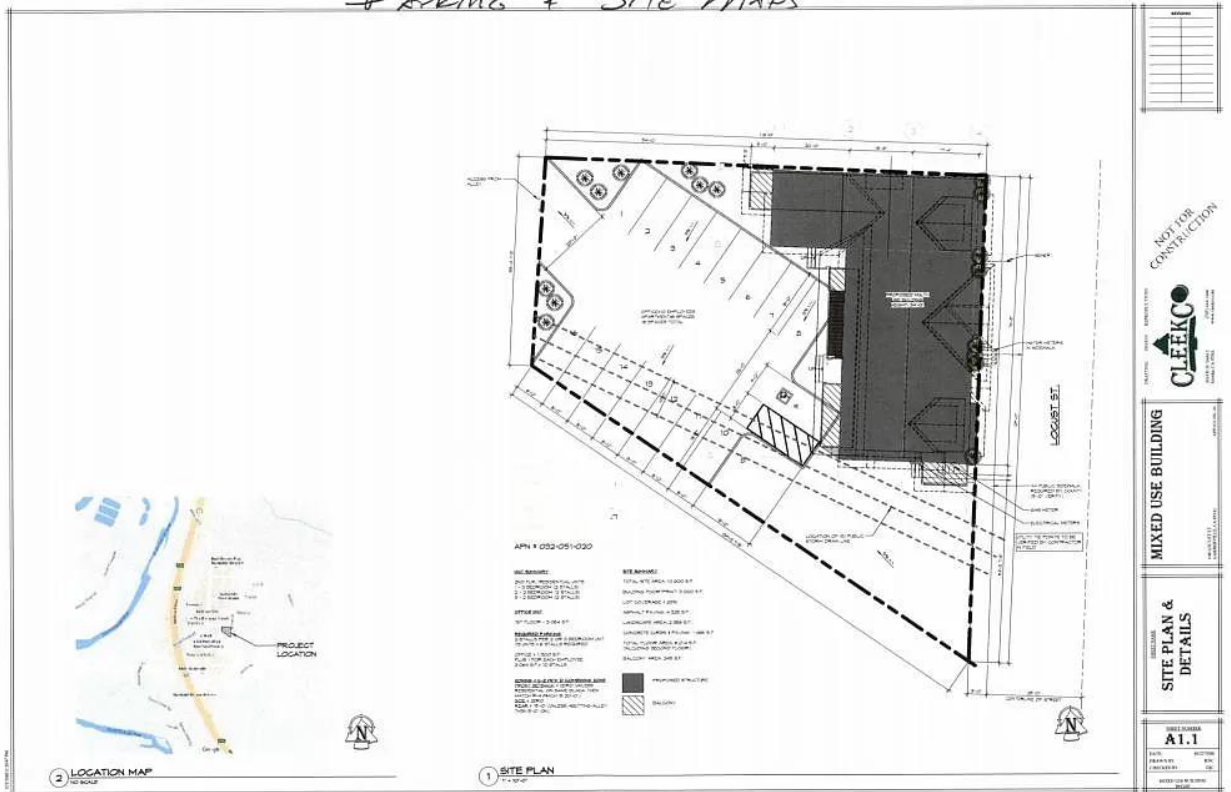

NOT FOR CONSTRUCTION

**CLEEKCO**

MIXED USE BUILDING

SITE PLAN & DETAILS

PROJECT NO. A1.1



NOT FOR CONSTRUCTION

**CLEEKCO**

MIXED USE BUILDING

RENDERINGS

PROJECT NO. A0.3

Figures 8 & 9: APN 032-051-020 Future Development



**Figure 10: View of Alley & Gate from Maple Lane**



**Figure 11: View of Gate at Getti Up Coffee & Johnston's Driveway**

IV. Deliveries

- A. There is plenty of space for fourteen feet by twenty-five feet (14'x25') loading zone on the backside of the property adjacent to the alley. This space has been plotted in Figure 7 to scale for reference.
- B. Cannabis deliveries are typically undertaken full-sized vans and large semi-tractor trailer trucks are not used.
- C. Full size vans average seven feet by twenty feet (7'x20') in size.
- D. Full size vans have a twenty-five feet or less (>25') turning radius.
- E. A full-size van has enough room within the alley to safely pull in, park upon the property within the loading zone, and pull out into the alley back to Maple Lane. A visualization of the van, turning radius, and its position during a turn have been plotted in Figure 7 to scale for reference.

V. Emergency Vehicle Access

- A. Public and private roadways are regulated by CCR Title 14 Division 1.5 Chapter 7 Subchapter 2 Articles 1-5 State Responsibility Area (SRA) Fire Safe Regulations.
  - 1. Roads and driveways, whether public or private, unless exempted under 14 CCR § 1270.02(d), shall provide for safe access for emergency wildfire equipment and civilian evacuation concurrently, and shall provide unobstructed traffic circulation during a wildfire emergency consistent with 14 CCR §§ 1273.00 through 1273.09.
  - 2. 14 CCR §1273.05(a) Turnarounds are required on driveways and dead-end roads.
  - 3. 14 CCR §1273.05(b) The minimum turning radius for a turnaround shall be forty (40) feet, not including parking, in accordance with the figures in 14 CCR §§ 1273.05(e) and 1273.05(f). If a hammerhead/T is used instead, the top of the "T" shall be a minimum of sixty (60) feet in length.
  - 4. 14 CCR §1273.05 (c) Driveways exceeding 150 feet in length, but less than 800 feet in length, shall provide a turnout near the midpoint of the driveway.
- B. Humboldt County Code Title III Division 11 Fire Safe Regulations Chapter 2 Emergency Access are identical to SRA requirements.
- C. There is currently sixty feet (60') hammerhead-T emergency vehicle access at the end of the alley upon APN 032-051-056 and 032-051-056. This turnaround has been plotted on Figure 7 for reference.
- D. Through access to Locust Street is blocked by a fence on APN 032-051-020 which also has future development plans for one-way parking access using the alley.
- E. Through access to Redwood Drive is blocked by Lehman's gate on APN 032-051-056.
- F. The gate upon Lehman's property will not stand in the way of emergency vehicles which are often used to ram obstacles over during an emergency and hose can be placed over the fence.

Based upon these facts there are no unusual circumstances arising from this project. The project is consistent with the use and nature of the property. There will not be any expansion of uses or structures under the proposed permit applications as all uses shall occur within the original footprint of enclosed spaces with the intent to be consistent with past associated uses. The permit applications are required as the first step to build and operate a compliant operation which meets current standards of public health and safety under County and State law.

Further, it is recommended that the County take into account future planned mixed-used development of APN 032-051-020 and look into a long-term solution to the alley including circulation. A potential easy solution is for the County to complete the alley connection to Redwood Drive via Rewood Properties, Getti Up, and Johnston's Motel driveways with fourteen and eight tens feet (14.8') roadway. This can be accomplished through eminent domain and fair market compensation of the road surface to the property owners as it is necessity to connect a public right of way alley from Redwood Drive to Maple Lane (Figure 12).

The downtown mixed-use area is in need of an alley connection as it is a developing city. The gate on Lehman's property which cuts off access could be considered blight as it is potentially deleterious to the surrounding community due to it's potential to block emergency vehicle access and cause further issues with future development. Due to a lack of inadequate planning in the past, eliminating current blight is an adequate justification for eminent domain of a public right of way alley, as it would negate the existence of a negative externality stemming from the property itself which affects neighboring businesses. Further, an alley created through eminent domain would promote economic development in within the business district, especially considering the future planned development next door on the vacant field, and therefore necessitates the development of the alley as a County maintain alley. It is justifiable to undertake eminent domain for the public need and purpose of the developing the alley which has been upheld by many planning related court cases.

Your Honors, I hope this letter and its explanations have been helpful in your approval determination of this project. I look forward to speaking with you and answering your questions in person at the upcoming public hearing. Thank you for your time and consideration.

Sincerely,



Joshua Allen

Plan It Techs, LLC (formerly CannaFarms Consulting, LLC)

*Masters Public Administration in Government Management, CSU Chico*

*Bachelors of Science Natural Resource Planning, Humboldt State*



Figure 12: Long-term Planning Circulation Recommendation



## CFP 1100 Low Profile Dry Chemical Fire Suppression System Unit Specifications:



**NYC Fire Dept.**  
**Certificate of Approval**  
**#5754**

Suppressing Agent: CF-33 ABC Dry Chemical Blend

Maximum Total Flood Volume: 10'x 10'x 13' = 1300 Cu. Ft.  
3.05m x 3.05m x 3.96m = 36.84 Cubic Meters

Reach Coverage Area: 10'x 10' = 100 Sq. Ft.  
3.05m x 3.05m = 9.30 Square Meters

Temperature Rating/Validation: - 20°F to 120°F / -29°C to 49°C

Cylinder: Worthington Cylinder

Diameter: 7.50" / 19.05cm

Length: 30.41" / 77.24cm

Capacity: 15.00 lbs / 6.80 kg

Unit Weight: 48.00 lbs / 21.78 kg

Ship Weight: 55.00 lbs / 24.95 kg

Operating Pressure: 175 psi / 1207 kPa

Propellant: High Purity Compressed Dry Nitrogen

Standard System Activation: 155°Fahrenheit / 68.3° Celsius

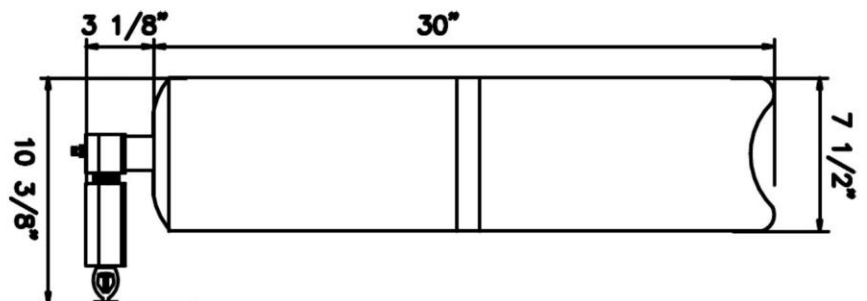

**Section 1 - Chemical Product and Company Identification**

**MSDS Name:** Ethanol, Absolute

**Synonyms:** Ethyl Alcohol; Ethyl Alcohol Anhydrous; Ethyl Hydrate; Ethyl Hydroxide; Fermentation Alcohol; Grain Alcohol

**Company Identification:**

VEE GEE Scientific, Inc.  
13600 NE 126th PI Ste A  
Kirkland, WA 98034

**For information in North America, call:** 425-823-4518

**Section 2 - Composition, Information on Ingredients**

CAS#	Chemical Name	Percent	EINECS/ELINCS
64-17-5	Ethanol	ca. 100	200-578-6

**Hazard Symbols:** F

**Risk Phrases:** 11

**Section 3 - Hazards Identification**

**Emergency Overview**

**Appearance:** Colorless clear liquid. Flash Point: 16.6 deg C. **Warning!** Flammable liquid and vapor. Causes respiratory tract irritation. May cause central nervous system depression. Causes severe eye irritation. This substance has caused adverse reproductive and fetal effects in humans. Causes moderate skin irritation. May cause liver, kidney and heart damage.

**Target Organs:** Kidneys, heart, central nervous system, liver.

**Potential Health Effects**

**Eye Contact:** Causes severe eye irritation. May cause painful sensitization to light. May cause chemical conjunctivitis and corneal damage.

**Skin Contact:** Causes moderate skin irritation. May cause cyanosis of the extremities.

**Ingestion:** May cause gastrointestinal irritation with nausea, vomiting and diarrhea. May cause systemic toxicity with acidosis. May cause central nervous system depression, characterized by excitement, followed by headache, dizziness, drowsiness, and nausea. Advanced stages may cause collapse, unconsciousness, coma and possible death due to respiratory failure.

**Inhalation:** Inhalation of high concentrations may cause central nervous system effects characterized by nausea, headache, dizziness, unconsciousness and coma. Causes respiratory tract irritation. May cause narcotic effects in high concentration. Vapors may cause dizziness or suffocation.

**Chronic Exposure:** May cause reproductive and fetal effects. Laboratory experiments have resulted in mutagenic effects. Animal studies have reported the development of tumors. Prolonged exposure may cause liver, kidney, and heart damage.

**Section 4 - First Aid Measures**

**Eye Contact:** Get medical aid. Gently lift eyelids and flush continuously with water.

**Skin Contact:** Get medical aid. Wash clothing before reuse. Flush skin with plenty of soap and water.

**Ingestion:** Do not induce vomiting. If victim is conscious and alert, give 2-4 cupfuls of milk or water. Never give anything by mouth to an unconscious person. Get medical aid.

**Inhalation:** Remove from exposure and move to fresh air immediately. If not breathing, give artificial respiration. If breathing is difficult, give oxygen. Get medical aid. Do NOT use mouth-to-mouth resuscitation.

**Notes to Physician:** Treat symptomatically and supportively. Persons with skin or eye disorders or liver, kidney, chronic respiratory diseases, or central and peripheral nervous system diseases may be at increased risk from exposure to this substance.

**Antidote:** None reported.

**Section 5 - Fire Fighting Measures**

**General Information:** Containers can build up pressure if exposed to heat and/or fire. As in any fire, wear a self-contained breathing apparatus in pressure-demand, MSHA/NIOSH (approved or equivalent), and full protective gear. Vapors may form an explosive mixture with air. Vapors can travel to a source of ignition and flash back. Will burn if involved in a fire. Flammable Liquid. Can release vapors that form explosive mixtures at temperatures above the flashpoint. Use water spray to keep fire-exposed containers cool. Containers may explode in the heat of a fire.

**Fire Extinguishing Media:** For small fires, use dry chemical, carbon dioxide, water spray or alcohol-resistant foam. For large fires, use water spray, fog, or alcohol-resistant foam. Use water spray to cool fire-exposed containers. Water may be ineffective. Do NOT use straight streams of water.

**Autoignition Temperature:** 363°C ( 685.40°F)

**Flash Point:** 16.6°C ( 61.88°F)

**Explosion Limits, lower:** 3.3 vol%.

**Explosion Limits, upper:** 19.0 vol%

**NFPA Rating:** (estimated) Health: 2; Flammability: 3; Instability: 0

## Section 6 -

## Accidental Release Measures

**General Information:** Use proper personal protective equipment as indicated in Section 8.

**Spills/Leaks:** Absorb spill with inert material (e.g. vermiculite, sand or earth), then place in suitable container. Remove all sources of ignition. Use a spark-proof tool. Provide ventilation. A vapor suppressing foam may be used to reduce vapors.

## Section 7 -

## Handling and Storage

**Handling:** Wash thoroughly after handling. Use only in a well-ventilated area. Ground and bond containers when transferring material. Use spark-proof tools and explosion proof equipment. Avoid contact with eyes, skin, and clothing. Empty containers retain product residue (liquid and/or vapor) and can be dangerous. Keep container tightly closed. Avoid contact with heat, sparks and flame. Avoid ingestion and inhalation. Do not pressurize, cut, weld, braze, solder, drill, grind, or expose empty containers to heat, sparks or open flames.

**Storage:** Keep away from heat, sparks, and flame. Keep away from sources of ignition. Store in a tightly closed container. Keep from contact with oxidizing materials. Store in a cool, dry, well-ventilated area away from incompatible substances. Flammables-area. Do not store near perchlorates, peroxides, chromic acid or nitric acid.

## Section 8 -

## Exposure Controls, Personal Protection

Chemical Name	ACGIH	NIOSH	OSHA - Final PELs	OSHA - Vacated Pels
Ethanol	1000 ppm	1000 ppm TWA 1900 mg/m3 TWA 3300 ppm IDLH	1000 ppm TWA 1900 mg/m3 TWA	1000 ppm TWA 1900 mg/m3 TWA

**Engineering Controls:** Use explosion-proof ventilation equipment. Facilities storing or utilizing this material should be equipped with an eyewash facility and a safety shower. Use adequate general or local exhaust ventilation to keep airborne concentrations below the permissible exposure limits.

### Personal Protective Equipment

**Eyes:** Wear appropriate protective eyeglasses or chemical safety goggles as described by OSHA's eye and face protection regulations in 29 CFR 1910.133 or European Standard EN166.

**Skin:** Wear appropriate protective gloves to prevent skin exposure.

**Clothing:** Wear appropriate protective clothing to prevent skin exposure.

**Respirators:** A respiratory protection program that meets OSHA's 29 CFR 1910.134 and ANSI Z88.2 requirements or European Standard EN 149 must be followed whenever workplace conditions warrant a respirator's use.

## Section 9 -

## Physical and Chemical Properties

**Physical State:** Clear liquid

**Appearance:** Colorless

**Odor:** Mild, pleasant

**pH:** Not available

**Vapor Pressure:** 59.3 mm Hg @ 20° C

**Vapor Density:** 1.59

**Evaporation Rate:** Not available

**Viscosity:** 1.200 cP @ 20° C

**Boiling Point:** 78° C

**Freezing/Melting Point:** -114.1° C

**Decomposition Temperature:** Not available

**Solubility:** Miscible

**Specific Gravity/Density:** 0.790 @ 20° C

**Molecular Formula:** C<sub>2</sub>H<sub>5</sub>OH

**Molecular Weight:** 46.0414

## Section 10 -

## Stability and Reactivity

**Chemical Stability:** Stable under normal temperatures and pressures.

**Conditions to Avoid:** Incompatible materials, ignition sources, excess heat, oxidizers.

**Incompatibilities with Other Materials:** Strong oxidizing agents, acids, alkali metals, ammonia, hydrazine, peroxides, sodium, acid anhydrides, calcium hypochlorite, chromyl chloride, nitrosyl perchlorate, bromine pentafluoride, perchloric acid, silver nitrate, mercuric nitrate, potassium-tert-butoxide, magnesium perchlorate, acid chlorides, platinum, uranium hexafluoride, silver oxide, iodine heptafluoride, acetyl bromide, disulfuryl difluoride, tetrachlorosilane plus water, acetyl chloride, permanganic acid, ruthenium (VIII) oxide, uranyl perchlorate, potassium dioxide.

**Hazardous Decomposition Products:** Carbon monoxide, irritating and toxic fumes and gases, carbon dioxide.

**Hazardous Polymerization:** Will not occur.

## Section 11 -

## Toxicological Information

**Carcinogenicity:** ACGIH: A4 - Not Classifiable as a Human Carcinogen

**Epidemiology:** Ethanol has been shown to produce fetotoxicity in the embryo or fetus of laboratory animals. Prenatal exposure to ethanol is associated with a distinct pattern of congenital malformations that have collectively been termed the "fetal alcohol syndrome".

**Teratogenicity:** Oral, Human - woman: TDLo = 41 gm/kg (female 41 week(s) after conception) Effects on Newborn - Apgar score (human only) and Effects on Newborn - other neonatal measures or effects and Effects on Newborn - drug dependence.

**Reproductive Effects:** Intrauterine, Human - woman: TDLo = 200 mg/kg (female 5 day(s) pre-mating) Fertility - female fertility index (e.g. # females pregnant per # sperm positive females; # females pregnant per # females mated).

**Neurotoxicity:** No information available.

**Mutagenicity:** DNA Inhibition: Human, Lymphocyte = 220 mmol/L.; Cytogenetic Analysis: Human, Lymphocyte = 1160 gm/L.; Cytogenetic Analysis: Human, Fibroblast = 12000 ppm.; Cytogenetic Analysis: Human, Leukocyte = 1 pph/72H (Continuous).; Sister Chromatid Exchange: Human, Lymphocyte = 500 ppm/72H (Continuous).

## Section 11 -

## Toxicological Information (continued)

**Other Studies:** Standard Draize Test(Skin, rabbit) = 20 mg/24H (Moderate) Standard Draize Test: Administration into the eye (rabbit) = 500 mg (Severe).

## Section 12 -

## Ecological Information

**Environmental Toxicity:** Fish: Rainbow trout: LC50 = 12900-15300 mg/L; 96 Hr; Flow-through @ 24-24.3°C Rainbow trout: LC50 = 11200 mg/L; 24 Hr; Fingerling (Unspecified) ria: Phytobacterium phosphoreum: EC50 = 34900 mg/L; 5-30 min; Microtox test 250 ppm/6hr/goldfish/lethal/fresh water.

**Environmental:** Ethanol: In water, will volatilize and probably degrade.

**Physical:** No information available.

**Other:** Not expected to bioconcentrate in fish.

## Section 13 -

## Disposal Considerations

Chemical waste generators must determine whether a discarded chemical is classified as a hazardous waste. US EPA guidelines for the classification determination are listed in 40 CFR Parts 261.3. Additionally, waste generators must consult state and local hazardous waste regulations to ensure complete and accurate classification.

**RCRA P-Series:** None listed.

**RCRA U-Series:** None listed.

## Section 14 -

## Transport Information

	US DOT	Canada TDG
Shipping Name	Ethanol	Ethanol
Hazard Class	3	3 (6.1)
UN Number	UN1170	UN1986
Packing Group	II	II
Other		FP 18C

## Section 15 -

## Regulatory Information

**US Federal**

**TSCA:** CAS# 64-17-5 is listed on the TSCA inventory.

**Health & Safety Reporting List:** None of the chemicals are on the Health & Safety Reporting List.

**Chemical Test Rules:** None of the chemicals in this product are under a Chemical Test Rule.

**Section 12b:** None of the chemicals are listed under TSCA Section 12b.

**TSCA Significant New Use Rule:** None of the chemicals in this material have a SNUR under TSCA.

**SARA:**

**CERCLA Hazardous Substances and corresponding RQs:** None of the chemicals in this material have an RQ.

**SARA Section 302 Extremely Hazardous Substances:** None of the chemicals in this product have a TPQ.

**SARA Codes:** CAS # 64-17-5: acute, chronic, flammable.

**Section 313:** No chemicals are reportable under Section 313.

**Clean Air Act:** This material does not contain any hazardous air pollutants. This material does not contain any Class 1 Ozone depleters. This material does not contain any Class 2 Ozone depleters.

**Clean Water Act:** None of the chemicals in this product are listed as Hazardous Substances under the CWA. None of the chemicals in this product are listed as Priority Pollutants under the CWA. None of the chemicals in this product are listed as Toxic Pollutants under the CWA.

**OSHA:** None of the chemicals in this product are considered highly hazardous by OSHA.

**STATE:** Ethanol can be found on the following state right to know lists: California, New Jersey, Pennsylvania, Minnesota, Massachusetts.

This product contains Ethanol, a chemical known to the state of California to cause birth defects or other reproductive harm.

California No Significant Risk Level: None of the chemicals in this product are listed.

**European/International Regulations****European Labeling in Accordance with EC Directives**

**Hazard Symbols:** F

**Risk Phrases:**

R 11 Highly flammable.

**Safety Phrases:**

S 7 Keep container tightly closed.

S 9 Keep container in a well-ventilated place.

S 16 Keep away from sources of ignition - No smoking.

S 33 Take precautionary measures against static discharges.

## Section 15 -

## Regulatory Information (continued)

**WGK (Water Danger/Protection):** CAS# 64-17-5: 0

**Canada - DSL/NDSL:** CAS# 64-17-5 is listed on Canada's DSL List.

**Canada - WHMIS:** This product has a WHMIS classification of B2, D2A.

**Canadian Ingredient Disclosure List:** CAS# 64-17-5 is listed on Canada's Ingredient Disclosure List.

**Exposure Limits:** CAS# 64-17-5: OEL-AUSTRALIA:TWA 1000 ppm (1900 mg/m3); OEL-BELGIUM:TWA 1000 ppm (1880 mg/m3); OEL-CZECHOSLOVAKIA:TWA 1000 mg/m3;STEL 5000 mg/m3; OEL-DENMARK:TWA 1000 ppm (1900 mg/m3); OEL-FINLAND:TWA 1000 ppm (1900 mg/m3);STEL 1250 ppm (2400 mg/m3); OEL-FRANCE:TWA 1000 ppm (1900 mg/m3);STEL 5000 pp; OEL-GERMANY:TWA 1000 ppm (1900 mg/m3); OEL-HUNGARY:TWA 1000 mg/m3;STEL 3000 mg/m3; OEL-THE NETHERLANDS:TWA 1000 ppm (1900 mg/m3); OEL-THE PHILIPPINES:TWA 1000 ppm (1900 mg/m3); OEL-POLAND:TWA 1000 mg/m3; OEL-RUSSIA:STEL 1000 mg/m3; OEL-SWEDEN:TWA 1000 ppm (1900 mg/m3); OEL-SWITZERLAND:TWA 1000 ppm (1900 mg/m3); OEL-THAILAND:TWA 1000 ppm (1900 mg/m3); OEL-TURKEY:TWA 1000 ppm (1900 mg/m3); OEL-UNITED KINGDOM:TWA 1000 ppm (1900 mg/m3) JAN9 OEL IN BULGARIA, COLOMBIA, JORDAN, KOREA check ACGIH TLV OEL IN NEW ZEALAND, SINGAPORE, VIETNAM check ACGI TLV

## Section 16 -

## Additional Information

**MSDS Creation Date:** 08/23/2004

*The information above is believed to be accurate and represents the best information currently available to us. However, we make no warranty of merchantability or any other warranty, express or implied, with respect to such information, and we assume no liability resulting from its use. Users should make their own investigations to determine the suitability of the information for their particular purposes. In no event shall VEE GEE Scientific be liable for any claims, losses, or damages of any third party or for lost profits or any special, indirect, incidental, consequential or exemplary damages, howsoever arising, even if VEE GEE Scientific has been advised of the possibility of such damages.*

# CUP-30

**CENTRIFUGE UTILITY PLATFORM**

## Closed-Loop Alcohol Extraction System

The CUP-30 is our large capacity centrifuge system that uses programmable sequences to target and extract your desired compounds from botanical biomasses. Utilizing closed-loop technology the CUP-30 has a runtime of 15-20 minutes and a throughput of approximately 600 lbs per 8-hour work day, ensuring the easy delivery of high-purity extractions.



**98%** Botanical Compound  
Removal



**97%** Alcohol Removal



**-40°C** Low Temperature  
Rating



**Dimensions** | CUP-30: w/o Auxiliary Components  
(49" L x 27.5" W x 58.5" H)

**Electrical Requirements** | 230v Three-Phase,  
Full-Load Amperage (FLA): 15

- Closed-Loop System
- 3rd Party Engineer Reviewed
- UL Listed US/Canada
- 304 & 316L Sanitary Stainless Steel
- Vacuum Jacket Insulation
- Easy Material Loading/Unloading
- Bi-Directional Agitation
- Variable Speed Control
- Heavy-Duty Spin Drying
- 6 Month Parts/Labor Warranty
- Technical Support
- Made in USA



# CUP-30

CENTRIFUGE UTILITY PLATFORM



Call Us: (707) 222-6066

sales@deltaseparations.com

-  **25-30 lbs** | Plant material per batch (depending on mill size)
-  **15-20 min** | Average Run Time (depending on SOP)
-  **25-30 gal.** | Alcohol Requirement Per Run (wash tincture can be used twice)



## Standard Features

### Vessel

- (1) Alcohol Feed Port: 1.5" Sanitary Triclamp Fittings
- (1) 1.5" Tri-clamp; Remote Discharge Vent and Pressure Relief Port
- 2" Tri-Clamp Angled Drain
- Liquid/Vapor Tight (No Pressure) Vessel with EPDM Lid Seal

### Dimensions

- CUP-30: w/o Auxiliary Components (49" L x 27.5" W x 58.5" H)
- Weight: 890 lbs / 404 kg
- Main Control Panel: (24" L x 32" W x 54" H)

### Controls

- Industrial HazLoc Control Panel
- Touchscreen HMI
- 20ft Tethered Control Panel (Installed Outside of HazLoc)
- Emergency Stop
- Variable Frequency Drive: 0-1500 RPM

### Electrical

- 230V, 15 amp, Three-Phase
- 5HP Motor
- UL-NEMA L15-30 Plug

### Included Ancillary Equipment

#### (1) 30 Gallon Jacketed Stainless Steel Discharge Vessel

- Dimensions 30"L x 30"W x 24"H
- Weight x 114 lbs / 52 kg

#### (1) Barrier Fluid Reservoir

- Dimensions - 39"L x 18"W x 56"H
- Weight x 113 lbs / 51 kg

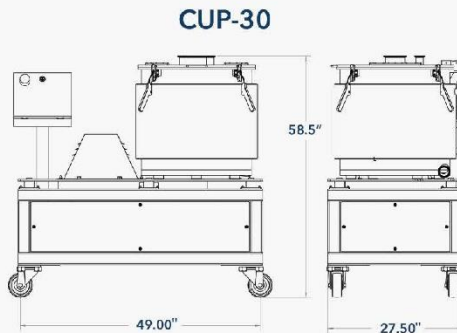

#### Main Control Panel

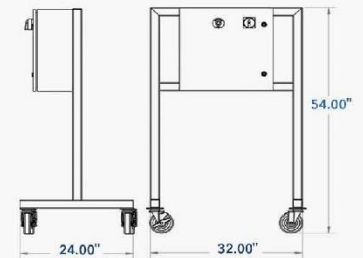

#### Barrier Fluid Reservoir

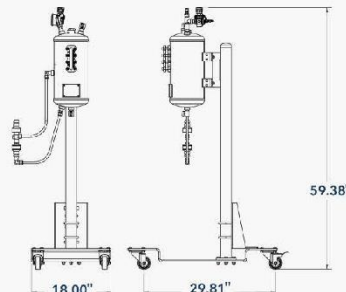

#### Discharge Vessel

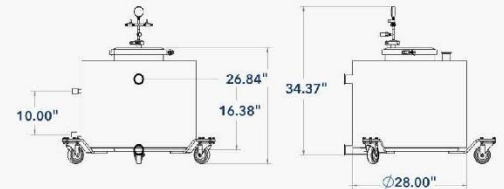

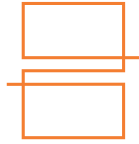

# HUMBOLDT COUNTY GROWERS ALLIANCE

March 10, 2020

Humboldt County Board of Supervisors  
825 5th St,  
Eureka, CA 95501

Attention Clerk of the Board, Kathy Hayes  
[KHayes@co.humboldt.ca.us](mailto:KHayes@co.humboldt.ca.us)

Regarding: Appeal from December 5, 2019, Planning Commission Approval of Emerald Triangle Group LLC's Special Permit Application Numbers PLN-12733-SP and PLN-12747-SP; Assessor's Parcel Number: 032-051-032; 829 Redwood Drive, Garberville Area.

Dear Board of Supervisors,

On behalf of the Humboldt County Growers Alliance, the trade association representing 266 legal Humboldt County cannabis businesses, which includes Emerald Triangle Group's, Joe Bilandzija, CEO of The Humboldt Cure—HCGA supports the Planning Commission's approval of two Special Permits for a Type 6 solventless manufacturing and Type 11 distribution facility on Redwood Dr. in Garberville.

HCGA attended the December 5, 2019 Planning Commission hearing and spoke on behalf of the project. We listened to the considerations discussed by Planning Staff and Commissioners and believe that all applicable environmental considerations were addressed by planning staff and the applicant.

One of the discussion points was about the walkability of Redwood Drive, and wanting to develop businesses with storefront capabilities that would benefit tourism and quality of life for residents and visitors. From our understanding, the Emerald Triangle Group is open to considering some type of storefront that would serve these benefits and needs, without jeopardizing their existing environmental analysis, or state licensing requirements.

Emerald Triangle Group has diligently moved their project forward through all environmental considerations over the past four years, culminating in approval at the Planning Commission. We ask you for your vote to deny the appeal, and allow the project to move forward.

Respectfully,

*Natalynne DeLapp*

Natalynne DeLapp  
Operations Director

HCGA.CO

427 F STREET, SUITE 213, EUREKA, CA, 95501



Honorable Supervisors,

I am writing in regards of my project located 825, & 827 Redwood Drive Garberville Ca 95542 (APN 032-051-032). We have applied for a special permit 12747 for and special permit 12733 for. The Project was approved by the planning commission on December 5<sup>th</sup> 2019. It involves distribution of cannabis out of 825 Redwood Dr, Non-Volatile manufacturing (excluding ethanol) out of 827 Redwood Dr, Non Volatile (Ethanol) extraction out of a proposed 12x16 metal building, and storage of cannabis in the 2 story storage containers. We have included a tourist destination that would consist of a viewing area. The project was appealed on December 18<sup>th</sup> 2019. The appellant cited concerns for odor, parking, fire safety, inappropriate use of C-2 zoning, and that the project was incorrectly exempt from CEQA EIR. My response to the concerns are as follows:

**Odor:**

Odor control will occur with the use of Activated Carbon Filters. The odor control system will be sized and designed in accordance with the California Building Code so that no odors leave the premises.



**Parking:**

The previous businesses in the building were a thrift shop and a restaurant, the cumulative calculated Occupancy Loads for both business was 31 persons. The new Occupancy Loads for the F-1 Factory Industrial Group reduces the Occupancy Load to 21 persons, cumulative for all license types based on the use and floor space. With the addition of the tourism viewing area an additional 10 persons is added to the occupancy load. This project has the same potential traffic impacts and parking impacts as the previous uses.

**Fire Safety:**

The metal building that will house the Ethanol extraction process will be designed to meet Moderate-Hazard Factory Industrial Group

requirements in the California Building Code, and be equipped with fire suppression.

The 3-story building will actually be safer after upgrading the electrical wiring to code.

The Fire Chief actually stated "The district objects to the volatile manufacturing portion of the proposed operation." There was confusion when the letter was sent to him and he received 2 applications one for Non-Volatile and one for Volatile manufacturing. Since we are not operating a Volatile manufacturing the Fire Chief is not opposed to the project.

#### **Appropriability of C-2 Zoning:**

Part 1 of Section A of Chapter 4 of Division 1 of Title III, Principal Zones:

Handicraft manufacture and wholesale outlet stores are mentioned as uses allowed with a use permit. As well as any use not specifically enumerated in this Division, if it is similar to and compatible with the uses permitted in the CG zone.

**(Ordinance 1.0)** Section 2.Section 314-55.4 of Chapter 4 of Division 1 of Title III is hereby amended to read as follows:

55.4.8.5 **Manufacturing** of commercial cannabis for medical use shall be a permitted use in zoning districts **C-2**, C-3, MB, ML, U (where developed as industrial use), and MH, subject to a Special Permit and the conditions and limitations set forth in this Section.

55.4.8.6 **Wholesale Distribution Facilities** for commercial cannabis for medical use shall be a permitted use in zoning districts **C-2**, C-3, MB, ML, U (where developed as industrial use), and MH, subject to a Special Permit and the conditions and limitations set forth in this Section.

**(Ordinance 2.0)** Ordinance No. 2599, amending sections 314-55.4, 314-55.3.11.7, 314-55.3.7 and 314-55.3.15 of Chapter 4 of Division 1 of Title III of the County Code (CCLUO for the Areas Outside the Coastal Zone)

#### 55.4.3 APPLICABILITY AND INTERPRETATION

55.4.3.1 All facilities and activities involved in the commercial cultivation, processing, manufacturing, and distribution, testing, and sale of cannabis within the jurisdiction of the County of Humboldt outside of the Coastal Zone shall be controlled by the provisions of this Section, regardless of whether those activities existed or occurred prior to the adoption of this Section. **Applications for Commercial Cannabis Activity land use permits filed on or before December 31, 2016 shall be governed by the regulations in effect at the time of their submittal**, except as follows and is otherwise prescribed herein. Zoning Clearance Certificate

applications for Open Air Cultivation filed on or before December 31, 2016 shall be controlled by the provisions of section 55.4.6.7 of this Section.

**55.4.6.7 Zoning Clearance Certificates for Open Air Cultivation submitted under prior ordinance -Provisions for Neighborhood Compatibility**

Where located in or within one thousand feet (1000') of any incorporated city, Sphere of Influence (SOI) of any incorporated city, Tribal Lands, or within any of the following mapped Community Planning Areas: Blue Lake, Fieldbrook-Glendale, Fortuna, Hydesville-Carlotta, McKinleyville, Rio Dell-Scotia, Shelter Cove, Trinidad-Westhaven, and Willow Creek, Zoning Clearance Certificate applications submitted prior to January 1, 2016 shall be subject to compliance with the following provisions, which are designed to ensure compatibility with surrounding land uses and control of potential nuisance, and are hereby retroactively applicable. For purposes of determining the Trinidad Planning Area, the City of Trinidad General Plan shall be utilized.

**CEQA:**

15301. EXISTING FACILITIES

Class 1 consists of the operation, repair, maintenance, permitting, leasing, licensing, or minor alteration of existing public or private structures, facilities, mechanical equipment, or topographical features, involving negligible or no expansion of existing or former use beyond that existing at the time of the lead agency's determination. The types of "existing facilities" itemized below are not intended to be all-inclusive of the types of projects which might fall within Class 1. The key consideration is whether the project involves negligible or no expansion of an existing use.

Examples include but are not limited to:

(a) Interior or exterior alterations involving such things as interior partitions, plumbing, and electrical conveyances;

(b) Existing facilities of both investor and publicly owned utilities used to provide electric power, natural gas, sewerage, or other public utility services;

(c) Existing highways and streets, sidewalks, gutters, bicycle and pedestrian trails, and similar facilities (this includes road grading for the purpose of public safety), and other alterations such as the addition of bicycle facilities, including but not limited to bicycle parking, bicycle-share facilities and bicycle lanes, transit improvements such as bus lanes, pedestrian crossings, street trees, and other similar alterations that do not create additional automobile lanes);

(d) Restoration or rehabilitation of deteriorated or damaged structures, facilities, or mechanical equipment to meet current standards of public health and safety, unless it is determined that the damage was substantial and resulted from an environmental hazard such as earthquake, landslide, or flood;

(e) Additions to existing structures provided that the addition will not result in an increase of more than:

- (1) 50 percent of the floor area of the structures before the addition, or 2,500 square feet, whichever is less; or
- (2) 10,000 square feet if:
- (A) The project is in an area where all public services and facilities are available to allow for maximum development permissible in the General Plan and
- (B) The area in which the project is located is not environmentally sensitive.
- (f) Addition of safety or health protection devices for use during construction of or in conjunction with existing structures, facilities, or mechanical equipment, or topographical features including navigational devices;
- (g) New copy on existing on and off-premise signs;
- (h) Maintenance of existing landscaping, native growth, and water supply reservoirs (excluding the use of pesticides, as defined in Section 12753, Division 7, Chapter 2, Food and Agricultural Code);
- (i) Maintenance of fish screens, fish ladders, wildlife habitat areas, artificial wildlife waterway devices, streamflows, springs and waterholes, and stream channels (clearing of debris) to protect fish and wildlife resources;
- (j) Fish stocking by the California Department of Fish and Game; *Association of Environmental Professionals 2019 CEQA Guidelines* 272
- (k) Division of existing multiple family or single-family residences into common-interest ownership and subdivision of existing commercial or industrial buildings, where no physical changes occur which are not otherwise exempt;
- (l) Demolition and removal of individual small structures listed in this subdivision:
- (1) One single-family residence. In urbanized areas, up to three single-family residences may be demolished under this exemption.
- (2) A duplex or similar multifamily residential structure. In urbanized areas, this exemption applies to duplexes and similar structures where not more than six dwelling units will be demolished.
- (3) A store, motel, office, restaurant, or similar small commercial structure if designed for an occupant load of 30 persons or less. In urbanized areas, the exemption also applies to the demolition of up to three such commercial buildings on sites zoned for such use.
- (4) Accessory (appurtenant) structures including garages, carports, patios, swimming pools, and fences.
- (m) Minor repairs and alterations to existing dams and appurtenant structures under the supervision of the Department of Water Resources.
- (n) Conversion of a single family residence to office use.
- (o) Installation, in an existing facility occupied by a medical waste generator, of a steam sterilization unit for the treatment of medical waste generated by that facility provided that the unit is installed and operated in accordance with the Medical Waste Management Act (Section 117600, et seq., of the Health and Safety Code) and accepts no offsite waste.
- (p) Use of a single-family residence as a small family day care home, as defined in Section 1596.78 of the Health and Safety Code.

**Note:** Authority cited: Section 21083, Public Resources Code;  
References: Sections 21084, Public Resources Code; *North County Advocates v. City of Carlsbad* (2015) 241 Cal.App.4th 94;  
*Communities for a Better Environment v. South Coast Air Quality Management Dist.* (2010) 48 Cal.4th 310; *Bloom v. McGurk* (1994) 26 Cal.App.4th 1307.

#### 15303. NEW CONSTRUCTION OR CONVERSION OF SMALL STRUCTURES

Class 3 consists of construction and location of limited numbers of new, small facilities or structures; installation of small new equipment and facilities in small structures; and the conversion of existing small structures from one use to another where only minor modifications are made in the exterior of the structure. The numbers of structures described in this section are the maximum allowable on any legal parcel. Examples of this exemption include, but are not limited to:

- (a) One single-family residence, or a second dwelling unit in a residential zone. In urbanized areas, up to three single-family residences may be constructed or converted under this exemption.
- (b) A duplex or similar multi-family residential structure, totaling no more than four dwelling units. In urbanized areas, this exemption applies to apartments, duplexes and similar structures designed for not more than six dwelling units.
- (c) A store, motel, office, restaurant or similar structure not involving the use of significant amounts of hazardous substances, and not exceeding 2500 square feet in floor area. In urbanized areas, the exemption also applies to up to four such commercial buildings not exceeding 10,000 square feet in floor area on sites zoned for such use if not involving the use of significant amounts of hazardous substances where all necessary public services and facilities are available and the surrounding area is not environmentally sensitive.
- (d) Water main, sewage, electrical, gas, and other utility extensions, including street improvements, of reasonable length to serve such construction.
- (e) Accessory (appurtenant) structures including garages, carports, patios, swimming pools, and fences.
- (f) An accessory steam sterilization unit for the treatment of medical waste at a facility occupied by a medical waste generator, provided that the unit is installed and operated in accordance with the Medical Waste Management Act (Section 117600, et seq., of the Health and Safety Code) and accepts no offsite waste.

**Note:** Authority cited: Section 21083, Public Resources Code;  
Reference: Sections 21084, Public Resources Code.

We believe that a Class 2 category exemption for 15302. REPLACEMENT OR RECONSTRUCTION would be applicable for the demolition and reconstruction of the proposed metal building.  
Thank you for considering my project. I look forward to a positive ruling.

Thanks-  
Joe "Fasho" Bilandzija

---

March 4, 2020

Dear Supervisors,

My name is Jesus Cogles, a resident of Garberville, CA and I am writing this letter in support of Emerald Triangle Groups distribution and manufacturing project located at 825 Redwood Dr. in Garberville, CA. I know a couple of the people involved with this project and extend my support because they are invested in the growth of our community by creating jobs and helping our economy in this small town. Also, with the legalization of cannabis in the state of California, legal businesses help support a regulated market where we can all benefit, versus black-market illegal activities. I truly hope you take my letter into consideration and give this project the opportunity it deserves.

Sincerely,

Jesus Cogles

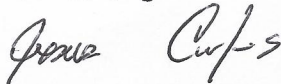

777 ALDERPOINT RD. GARBERVILLE, CA. 95542

Dear Board of Supervisors,

I am writing this letter in hopes that you hear my story and realize that a project such as the one the Emerald Triangle Group is proposing will bring much needed relief to our community. My family has owned and operated the Alderpoint General Store for the last 30 years, which created an avenue to form tight knit personal relationships with people in our community. Everyone that comes to the AP Store to get their cold drinks, a snack or a sandwich from the deli, also get to socialize with others and talk about life. Imagine being the cashier or manager there, you know everyone's gossip. Sometimes I would joke that the cashiers are more like therapists for certain people in town. It has always been a safe place to meet up, charge your phone or get cell service. People have always looked to the Alderpoint Store for more than just groceries. With all that being said, over these last few years, while cannabis legalization was being established, the stories of these customers and friends have changed. The tone of these tales was once filled with joy and prosperity, but now the dialogue and feelings of our community have changed to dreary, confused and almost hopeless. Everyone in Humboldt County felt the sting that legalization brought onto us. Cannabis legalization has brought small family legacy farms on their knees and out of their pockets, to try and find other means of income. Most people in my community are struggling and like most other businesses, the Alderpoint Store's revenue is tied directly to our community's economy. When the community is thriving, the store is thriving as well. Right now, the AP store is not doing well. We are struggling to put items on our shelves, and are unable to make necessary repairs to our gas pumps to provide fuel for the community, which is a very important necessity living in the hills. It has now gotten to the point me and my family have made the decision to lease out the store because we have emptied our savings accounts trying to keep the store alive during this time. People all over town are selling their houses and moving away. People I thought I would never see leave this place packing up and moving out of state, that is if they are lucky enough to sell their property. Alderpoint already had a bad reputation because of the rowdy people that live here, but now when people drive through its desolate and almost resembles a ghost town. The Alderpoint Store is feeling what the farmers feel. We are hurting with the community. The Schultz's love this community because it has kept our family fed for the last 30 years and I know that this struggle that we are

all going through is because a lack of resources provided to the cannabis cultivators in Southern Humboldt. From the West side to the East side of Southern Humboldt, farmers are being stripped of their land and homes, because the people of our beautiful community are doing the thing we know how to do, which is cannabis farming. Even though cannabis has been legalized there still aren't any avenues or easy access points for the small farmer to distribute their product in Southern Humboldt. Most of these farms are in the hills that take some skill getting to and you must be familiar with the area to even find some of these farms. Having a local person such as Joe Bilandzija open a distribution center in Garberville gives the hill farmers an advantage because he is familiar with this area and he is able to identify with the average farmer, because he is one too. I believe that having a cannabis distribution facility in Garberville will greatly improve the success rate of the legal farmer in our community, and the end result will be that the rest of the community will thrive as well. I truly believe that by giving the famers an outlet in a town they are already familiar with bring some positivity back to the community. Our small stores, our farmers and our community need this.

Thank you for your time and consideration,

Leeana Schultz

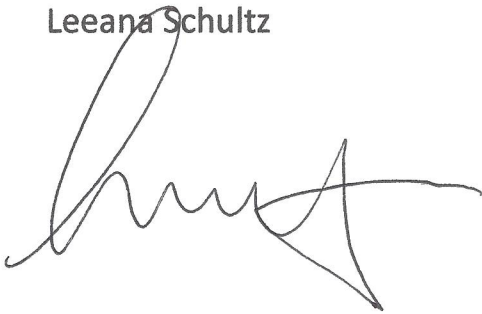
A handwritten signature in black ink, appearing to read 'Leeana Schultz', written in a cursive style.





January 30, 2020

To: Humboldt County Board of Supervisors

My name is David Nicoletti, I am the owner of DTN Engineering and a licensed Civil Engineer. As the Civil Engineer for this project I am writing in support of the Emerald Triangle Group facility being that is being proposed at 82 Redwood Dr Garberville, California. The property at this address is Zoned Commercial General (CG), which allows Light Industrial as a Conditionally Permitted Use. The activities that will be occurring at this property qualify as Light Industrial in accordance with the legal definition of Light Industrial.

The legal definition for Light Industrial is as follows:

*Light industry refers to manufacturing activity that uses moderate amounts of partially processed materials to produce items of relatively high value per unit weight. Light industries require only a small amount of raw materials, area and power. The value of the goods produced is relatively low and they are easy to transport. Light industries cause relatively little pollution when compared to heavy industries. As light industry facilities have less environmental impact than those associated with heavy industry zoning laws permit light industry near residential areas. It is a criterion for zoning classification. The manufacturing of clothes, shoes, furniture, consumer electronics and household items are a few examples of light industries.*

The legal definition of Light Industrial fits the use of this project and since the improvements required for a change of occupancy are minimal, I concur with County Staff's assessment that the project is exempt from CEQA.

This project qualifies in the CBC as Factory Industrial Group F-1, which fits in with the legal definition of Light Industrial above. This project's Factory Use as F-1 impacts the Occupancy Loads by reducing it from the Occupancy Loads from the previous businesses that were in this building. The previous businesses in the building on the first floor were a thrift shop and a restaurant, the cumulative calculated Occupancy Loads for both business was 31 persons and the new Occupancy Loads for the F-1 Factory Industrial Group reduces the Occupancy Load to 21 persons cumulative for both license types based on the used and floor space. This reduction decreases the traffic impacts and parking impacts from the previous businesses.

This project will be using Cold Water Extraction inside of the main building to manufacture "Bubble Hash". The Ethanol extraction process being used on this property will occur in a newly constructed metal building that will be replacing the concrete structure (icehouse) behind the main structure. The Ethanol is contained within a solid-state extraction machine and will be placed within spill containment. The metal building will be designed and constructed to meet CBC requirements for the F-1 Factory Industrial Group. The first floor of the building will be improved to meet current electrical, plumbing, mechanical, and ADA Code requirements improving the integrity of the building from its current condition.

2731 K Street Unit A Eureka, CA 95501  
Ph: (916) 215-7769  
Email: dnicoletti@dtngineering.com



In accordance with the Commercial Cannabis Land Use Ordinance (CCLUO) and with the State of California Bureau of Cannabis Control (BCC) requirements for both odor control and security. The odor control will be designed such that odors will not leave the building do to the fact that there are no side setbacks from the property line to the building.

The ancillary benefits for having this business located on Redwood Drive in Garberville will be a reduction in vagrancy due to an operational businesses, employees will be spending money with local business purchasing food, drinks, gas, etc., and help local cultivators in Southern Humboldt get their product to market using the Distribution side of the business. The overall impacts to the community will be overwhelmingly positive and I encourage the County Board of Supervisors to approve this project.

Thank you very much for this consideration.

Sincerely

*David Nicoletti*

David Nicoletti PE #76814

The Hemp Connection  
412 Maple Garberville, CA. 95542  
707 934- 4851  
Marie Mills  
March 6, 2020

To Whom It May Concern:

My name is Marie Mills, co-owner of The Hemp Connection retail business located on the 800 block of Redwood Drive, Garberville, CA. I am writing this letter in support Joseph Bilandzija of the Emerald Triangle Group, LLC, Co. located at 829 Redwood Drive, Garberville.

On Dec. 5 2019 the Humboldt County Planning Commission approved the permits required for the Emerald Triangle Group to manufacture cannabis, using non volatile means and to distribute the manufactured product to legally permitted dispensaries.

A number of business owners on the 800 block of Redwood Drive have expressed opposition to the Emerald Triangle Group being permitted to manufacturing at the 829 Locust Street location because of the fire danger. They also express concerns about traffic and parking at this location.

Having heard about fires in Humboldt County caused by butane explosions during the extraction process of CBD and THC elements in the manufacture of Cannabis products, I decided to do some computer research. I discovered that the closed loop ethanol extraction system is one of the safest methods available with a very low fire risk. Joseph Bilandzija has informed me that his Emerald Triangle group plans to use this safe method in their manufacture of Cannabis products. Because the Emerald Group plans to pick up and deliver to permitted dispensaries, there should be no issues concerning traffic or parking. Joseph has rented 1 parking space for the year 2020 at The Hemp Connections' private parking lot for his van, which will be used for pick up and delivery.

I support Joseph Bilandzija of the Emerald Triangle Group in being allowed to open his business in the very near future. Four businesses on the 800 block of Redwood drive have closed in the last 2 years.leaving empty buildings. There are plenty of empty public parking spaces on the street and a great need for new businesses to open in order for Garberville to survive this economic recession. I believe Joseph and his group would be an asset to our business community by helping with our recovery.

Sincerely,

Marie Mills  
The Hemp Connection

3/7/2020

Dear Board of Supervisors,

My name is Vivian Mou. The owner of Humboldts Dankest, a cannabis company based out of Myers Flat. I support the Emerald Triangle Group's distribution and manufacturing project located in Garberville. They are very good people and are a valuable asset to the community. They can also provide services to many farms like mine for processing and packaging services. It will benefit all the little mom and pops farm; whom are the culture of our county and the roots of the cannabis culture. However, many of us do not have the funding to be set up fully to run our business the way we would like to. Therefore, having this type of company being up will help and give us small time farmer more options in continuing our business. Thank you for your time and consideration.

Sincerely,

Vivian Mou



03/07/2020



Charles Perry

777 Alderpoint Rd. Garberville, CA. 95542

adamperry702@gmail.com

March 4, 2020

Dear Supervisors,

My name is Charles Perry and I am a resident of Garberville, CA. I am writing this letter in support of my friends at Emerald Triangle Groups Distribution and Manufacturing project located at 825 Redwood Dr. in Garberville, CA. I am hoping to partner with this project in the near future for legal cannabis and manufacturing needs. More importantly, this project will help our community through job creation, and revenue from taxes. A project like this will only help in the growth of our community while supplementing a need for legal cannabis businesses. I hope you take my letter into consideration and let this project continue.

Sincerely yours,

Charles Perry

"TO THE BOARD OF"  
SUPERVISORS

HELLO MY NAME IS CHAD MUSSEY  
OWNER OF BENTZOW VALLEY FARMS. I'VE  
BEEN LIVING IN HUMBOLDT COUNTY FOR 23  
YEARS AND COUNTING. I'VE KNOWN JOSEPH  
BILANDZITA ALL HIS LIFE. JOSEPH ALWAYS  
HAS BEEN A STAND UP HUMAN BEING AND  
OUR COMMUNITY NEED HIS PROFESSIONALISM IN  
THIS COMMUNITY. HE HAS AN OPPORTUNITY TO  
HELP THIS COMMUNITY GET BACK ON ITS FEET  
RIGHT HERE IN HUMBOLDT COUNTY SPECIALLY  
HERE IN BARBERVILLE. AS A COMMUNITY  
WE NEED JOSEPH'S DISTRIBUTION BUSINESS.  
I'VE NOTICED WITH THE COMMUNITY WE LIVE  
IN IT BUT AS PROSPEROUS AS IT ONCE  
WAS. NOW THAT CANNABIS IS LEGAL AND  
WE AS FARMERS NEED DISTRIBUTION  
BUSINESS'S TO DEPEND ON SPECIALLY BEING  
A FARMER HERE IN HUMBOLDT COUNTY. BUT  
MOST IMPORTANT WE NEED MORE DISTRIBUTION  
HERE LOCALLY IN BARBERVILLE CALIFORNIA.

AND AS OF NOW WITH THE STATE AND  
HERE IN Humboldt County MORE AND MORE  
LEGAL Cannabis FARMS ARE BEING PERMITTED.  
AND BECAUSE OF THAT THERES GOING TO MUCH  
PRODUCT AND NOT ENOUGH DISTROBUTORS TO  
SELL OUR FARM PRODUCT. IF ANYTHING  
WE NEED MORE DISTROBUTORS RIGHT HERE  
IN SOUTHERN Humboldt County. ESPECIALLY  
HERE IN GARBERVILLE Ca. SO PLEASE HELP  
US HELP OUR COMMUNITY GROW TOGETHER  
TO HELP EACH OTHER SERIVE IN A  
GROWING Cannabis BUSINESS. WE AS FARMERS  
NEED ALL THE HELP WE CAN GET. I  
ALSO HAVE A FAMILY LIKE JOSEPH BILANDITA  
I HAVE THREE BOYS AND A BEAUTIFUL WIFE.  
AND WE NEED TO STICK TOGETHER IN THIS  
SMALL TOWN AND STAY TOGETHER AND GROW  
TOGETHER TO TRY TO BE ~~Successfull~~ Successfull.  
IN OUR COMMUNITY ITS GOING TO BE HARDER TO  
SERIVE WITHOUT A DISTRO HERE IN GARBERVILLE  
SO PLEASE HELP US. THANK YOU FOR  
READING MY LETTER.

Shedley

Cristina Bejarano

827 Redwood Dr.

Suite C

Garberville, CA 95542

March 3, 2020

Dear Supervisors,

My name is Cristina Bejarano, I am a resident of Garberville, CA since 2018. I am writing to show support for Emerald Triangle Groups distribution and manufacturing project located at 825 Redwood Dr. Garberville, CA. I truly believe this project will positively impact the town of Garberville by helping our economy through the creation of jobs, as well as revenue/taxes.

Please take my letter into consideration as I would love to continue to see our community grow and this project will do just that.

Sincerely,

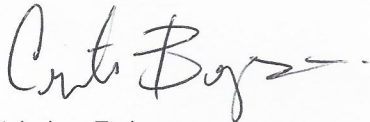
A handwritten signature in black ink that reads "Cristina Bejarano". The signature is written in a cursive style with a long horizontal flourish at the end.

Cristina Bejarano



Dee Nelson  
P.O. Box 684  
Redway, CA 95560

March 9, 2020

RE: Emerald Triangle Group Project

To Whom it May Concern,

I met Joe Bilandzija 5 years ago when he was a volunteer coach and sponsor for the Southern Humboldt Youth Basketball League while I was President of the organization. I have always found Joe to be an honest, respectful, and strait forward guy who gives of his time and energy for the betterment of our community. I have watched Joe build his businesses on those same principals.

Southern Humboldt, Garberville in particular, is at an economic crossroads. It's heartbreaking to walk down the street and see empty store fronts, knowing personally the families who have had to close their doors because of the negative trickle down effect cannabis legalization has had on our community. I currently own the oldest gift shop in Humboldt County and for over a year the three businesses next to me on Redwood Drive were empty. Tourists and locals alike would regularly comment about how uninviting it made the town. Unfortunately, we aren't the only block in this small town struggling with this issue. The block the Emerald Triangle Group is attempting to put their business on is littered with closed and empty store fronts and the space they will occupy has been unused for over a year and a half. These vacancies hurt all the businesses in town. The empty feeling of town caused by these vacancies mean people are shopping here less and many times the properties are squatted in front of by homeless individuals, vandalized, and collect litter further discouraging shopping and tourism further. The Emerald Triangle Group project will help to revitalize the main street of Garberville.

I acted as the Executive Director of the Southern Humboldt Chamber of Commerce for nine years and time and time again I was told that Humboldt needs to be the "Napa of cannabis." Yet we have very little infrastructure or support businesses to make that transition and attract new tourism dollars. Joe's plan for the Emerald Triangle Group space will not only create much needed jobs, but will offer opportunity for community organizations to lead educational tours on a daily basis. The services the Emerald Triangle Group Plans to offer from the space in question will also benefit the community by keeping local money in the local economy. Giving farmers the option to utilize the services of the Emerald Triangle Group allows them to continue to compete in the market place in crucial if we to save the Southern Humboldt economy.

Joe's entrepreneurial attitude and true passion for cannabis will not only move the industry forward, but also help to solidify Humboldt's place in the market. Please consider the positive effect the Emerald Triangle Group Project will have on the Southern Humboldt Community and allow them to move forward.

Sincerely,



Dee Nelson

**From:** [Coach](#)  
**To:** [Luther, Stephen](#)  
**Subject:** Fwd: ridgeline letter  
**Date:** Tuesday, March 10, 2020 11:49:27 PM

---

Hello Stevie,

Could this letter be added as a supplemental?

Best-

Joe "Fasho" Bilandzija |CEO |The Humboldt Cure, INC

Humboldt, California

(707) 951-7185

[info@thehumboldtcure.com](mailto:info@thehumboldtcure.com)

[www.thehumboldtcure.com](http://www.thehumboldtcure.com)

\*Check out our regenerative farmed cannabis products at

[www.thehumboldtcure.org](http://www.thehumboldtcure.org)

\*Don't miss out on our limited edition gear available exclusively at [www.curemerch.com](http://www.curemerch.com)

**CONFIDENTIALITY NOTICE:** This email and attachments within are intended for the above recipient only. You may not reproduce or publish this email, or its contents, without our written consent. If you have received this email by error please contact us immediately at [support@thehumboldtcure.com](mailto:support@thehumboldtcure.com) and immediately delete all record of it from your digital and physical records.

[|Sign Up Now | Instagram| Facebook|](#)

Ca Cannabis License Numbers PAL18-0002631, PAL18-0001153, PAL18-0000138

---

**From:** jason gellman <[supergellman@hotmail.com](mailto:supergellman@hotmail.com)>

**Sent:** Tuesday, March 10, 2020 7:17 PM

**To:** [coach@thehumboldtcure.com](mailto:coach@thehumboldtcure.com)

**Subject:** ridgeline letter

To Whom It May Concern,

I am writing this letter in support of Joe Bilandzija ?, in his endeavor to open a cannabis extraction facility and distribution center in Garberville, CA. I am the owner of Ridgeline Farms, a licensed cannabis farm near Garberville, CA, a life-long resident and active community member here in Southern Humboldt. As a small farmer, I believe it is imperative that new business' supporting processing/extraction and distribution are created and thrive within this community. Both as a means to allow small farms, like my own, to succeed, and for our local economy to thrive. Having a small cannabis farm is hard, navigating sales through the newly formed legal system has been a constant struggle with many ups and downs. Many of the closest distributors to us are over 1.5 hours away from our town, and a lot of farms are much farther from town which adds a lot of travel time to meet with potential distributors, schedule product sampling and testing, pickups/deliveries, check in with them and schedule picking up payment which is often in small amounts many times rather than one full invoice payment, all happening for multiple batches throughout a year. That is the reality of being in this business, having more Buisness' that can serve those needs in a local setting will help all of us succeed in a time when we need all the help we can get.

On both a personal and professional level I have known Joe for quite some time, he is a smart business man and has strong community values. I believe we, as a town, should do all we can to

help those who are willing to put in the considerable time and money it takes to work in this industry and succeed. We need to support this business plan and see its benefit both for ourselves and the next generations looking to live and thrive in this beautiful small town.

Thank you for your time  
Jason Gellman