

HUMBOLDT COUNTY DEPARTMENT OF PUBLIC WORKS
ROAD EVALUATION REPORT

PART A: *Part A may be completed by the applicant*

Applicant Name: Ladonna Auxier APN: 216-382-059

Planning & Building Department Case/File No.: 12628

Road Name: Rancho Sequoia *(complete a separate form for each road)*

From Road (Cross street): Alderpoint Rd

To Road (Cross street): Upper Willow Rd.

Length of road segment: 2.10 miles Date Inspected: July 17, 2019

Road is maintained by: County Other Road Maintenance Association
(State, Forest Service, National Park, State Park, BLM, Private, Tribal, etc)

Check one of the following:

Box 1 The entire road segment is developed to Category 4 road standards (20 feet wide) or better. If checked, then the road is adequate for the proposed use without further review by the applicant.

Box 2 The entire road segment is developed to the equivalent of a road category 4 standard. If checked, then the road is adequate for the proposed use without further review by the applicant.

An equivalent road category 4 standard is defined as a roadway that is generally 20 feet in width, but has pinch points which narrow the road. Pinch points include, but are not limited to, one-lane bridges, trees, large rock outcroppings, culverts, etc. Pinch points must provide visibility where a driver can see oncoming vehicles through the pinch point which allows the oncoming vehicle to stop and wait in a 20 foot wide section of the road for the other vehicle to pass.

Box 3 The entire road segment is not developed to the equivalent of road category 4 or better. The road may or may not be able to accommodate the proposed use and further evaluation is necessary. Part B is to be completed by a Civil Engineer licensed by the State of California.

The statements in PART A are true and correct and have been made by me after personally inspecting and measuring the road.

David Nicoletti

Signature

August 18, 2019

Date

David Nicoletti PE #76814

Name Printed

Important: Read the instructions before using this form. If you have questions, please call the Dept. of Public Works Land Use Division at 707.445.7205.

PART B: Only complete Part B if Box 3 is checked in Part A. Part B is to be completed by a Civil Engineer licensed by the State of California. Complete a separate form for each road.

Road Name: Rancho Sequoia Date Inspected: July 17, 2019 APN: 216-382-059
 From Road: Alderpoint Rd (Post Mile _____) Planning & Building
 To Road: Upper Willow Rd (Post Mile 2.10) Department Case/File No.:
 12628

1. What is the Average Daily Traffic (ADT) of the road (including other known cannabis projects)?

Number of other known cannabis projects included in ADT calculations:
 (Contact the Planning & Building Department for information on other nearby projects.) _____

ADT: <400 Date(s) measured: July 17, 2019

Method used to measure ADT: Counters Estimated using ITE Trip Generation Book

Is the ADT of the road less than 400? Yes No

If YES, then the road is considered very low volume and shall comply with the design standards outlined in the American Association of State Highway and Transportation Officials (AASHTO) Guidelines for Geometric Design of Very Low-Volume Local Roads (ADT ≤400). Complete sections 2 and 3 below.

If NO, then the road shall be reviewed per the applicable policies for the design of local roads and streets presented in AASHTO A Policy on Geometric Design of Highways and Streets, commonly known as the "Green Book". Complete section 3 below.

2. Identify site specific safety problems with the road that include, but are not limited to: (Refer to Chapter 3 in AASHTO Guidelines for Geometric Design of Very Low-Volume Local Roads (ADT ≤400) for guidance.)

A. Pattern of curve related crashes.

Check one: No. Yes, see attached sheet for Post Mile (PM) locations.

B. Physical evidence of curve problems such as skid marks, scarred trees, or scarred utility poles

Check one: No. Yes, see attached sheet for PM locations.

C. Substantial edge rutting or encroachment.

Check one: No. Yes, see attached sheet for PM locations.

D. History of complaints from residents or law enforcement.

Check one: No. Yes (check if written documentation is attached)

E. Measured or known speed substantially higher than the design speed of the road (20+ MPH higher)

Check one: No. Yes.

F. Need for turn-outs.

Check one: No. Yes, see attached sheet for PM locations.

3. Conclusions/Recommendations per AASHTO. Check one:

The roadway can accommodate the cumulative increased traffic from this project and all known cannabis projects identified above.

The roadway can accommodate the cumulative increased traffic from this project and all known cannabis projects identified above, if the recommendations on the attached report are done. (check if a Neighborhood Traffic Management Plan is also required and is attached.)

The roadway cannot accommodate increased traffic from the proposed use address increased traffic.

A map showing the location and limits of the road being evaluated in PART B is attached. The statements in PART B are true and correct and have been made by me after personally evaluating the road.

David Nicoletti
 Signature of Civil Engineer

August 18, 2019
 Date



Important: Read the instructions before using this form. If you have questions, please call the Dept. of Public Works Land Use Division at 707.445.7205.

HUMBOLDT COUNTY DEPARTMENT OF PUBLIC WORKS
ROAD EVALUATION REPORT

PART A: *Part A may be completed by the applicant*

Applicant Name: Ladonna Auxier APN: 216-382-059

Planning & Building Department Case/File No.: 12628

Road Name: Upper Willow Rd (complete a separate form for each road)

From Road (Cross street): Rancho Sequoia

To Road (Cross street): Private Driveway

Length of road segment: APN 216-382-059 miles Date Inspected: July 17, 2019

Road is maintained by: County Other Road Maintenance Association
(State, Forest Service, National Park, State Park, BLM, Private, Tribal, etc)

Check one of the following:

Box 1 The entire road segment is developed to Category 4 road standards (20 feet wide) or better. If checked, then the road is adequate for the proposed use without further review by the applicant.

Box 2 The entire road segment is developed to the equivalent of a road category 4 standard. If checked, then the road is adequate for the proposed use without further review by the applicant.

An equivalent road category 4 standard is defined as a roadway that is generally 20 feet in width, but has pinch points which narrow the road. Pinch points include, but are not limited to, one-lane bridges, trees, large rock outcroppings, culverts, etc. Pinch points must provide visibility where a driver can see oncoming vehicles through the pinch point which allows the oncoming vehicle to stop and wait in a 20 foot wide section of the road for the other vehicle to pass.

Box 3 The entire road segment is not developed to the equivalent of road category 4 or better. The road may or may not be able to accommodate the proposed use and further evaluation is necessary. Part B is to be completed by a Civil Engineer licensed by the State of California.

The statements in PART A are true and correct and have been made by me after personally inspecting and measuring the road.

David Nicoletti

August 18, 2019

Signature

Date

David Nicoletti PE #76814

Name Printed

Important: Read the instructions before using this form. If you have questions, please call the Dept. of Public Works Land Use Division at 707.445.7205.

PART B: Only complete Part B if Box 3 is checked in Part A. Part B is to be completed by a Civil Engineer licensed by the State of California. Complete a separate form for each road.

Road Name: Upper Willow Rd Date Inspected: July 17, 2019 APN: 216-382-059
 From Road: Rancho Sequoia (Post Mile _____) Planning & Building
 To Road: Private Driveway APN 216-382-059 (Post Mile .12) Department Case/File No.:
 12628

1. What is the Average Daily Traffic (ADT) of the road (including other known cannabis projects)?

Number of other known cannabis projects included in ADT calculations:
 (Contact the Planning & Building Department for information on other nearby projects.) _____

ADT: <400 Date(s) measured: July 17, 2019

Method used to measure ADT: Counters Estimated using ITE Trip Generation Book

Is the ADT of the road less than 400? Yes No

If YES, then the road is considered very low volume and shall comply with the design standards outlined in the American Association of State Highway and Transportation Officials (AASHTO) Guidelines for Geometric Design of Very Low-Volume Local Roads (ADT ≤400). Complete sections 2 and 3 below.

If NO, then the road shall be reviewed per the applicable policies for the design of local roads and streets presented in AASHTO A Policy on Geometric Design of Highways and Streets, commonly known as the "Green Book". Complete section 3 below.

2. Identify site specific safety problems with the road that include, but are not limited to: (Refer to Chapter 3 in AASHTO Guidelines for Geometric Design of Very Low-Volume Local Roads (ADT ≤400) for guidance.)

A. Pattern of curve related crashes.

Check one: No. Yes, see attached sheet for Post Mile (PM) locations.

B. Physical evidence of curve problems such as skid marks, scarred trees, or scarred utility poles

Check one: No. Yes, see attached sheet for PM locations.

C. Substantial edge rutting or encroachment.

Check one: No. Yes, see attached sheet for PM locations.

D. History of complaints from residents or law enforcement.

Check one: No. Yes (check if written documentation is attached)

E. Measured or known speed substantially higher than the design speed of the road (20+ MPH higher)

Check one: No. Yes.

F. Need for turn-outs.

Check one: No. Yes, see attached sheet for PM locations.

3. Conclusions/Recommendations per AASHTO. Check one:

The roadway can accommodate the cumulative increased traffic from this project and all known cannabis projects identified above.

The roadway can accommodate the cumulative increased traffic from this project and all known cannabis projects identified above, if the recommendations on the attached report are done. (check if a Neighborhood Traffic Management Plan is also required and is attached.)

The roadway cannot accommodate increased traffic from the proposed use address increased traffic.

A map showing the location and limits of the road being evaluated in PART B is attached. The statements in PART B are true and correct and have been made by me after personally evaluating the road.

David Nicolette
 Signature of Civil Engineer

August 18, 2019
 Date



Important: Read the instructions before using this form. If you have questions, please call the Dept. of Public Works Land Use Division at 707.445.7205.

From: David Nicoletti PE QSD\QSP
DTN Engineering & Consulting
2731 K Street Unit A
Eureka, CA 95501
Email: dnicoletti@dtngineering.com

Subject: Roadway Evaluation for APN #216-382-059, APPS 12628

Introduction

On July 17, 2019, DTN Engineering & Consulting (Engineer) performed a roadway evaluation for Ladonna Auxier upon request from Humboldt County Public Works. Humboldt County Public Works has provided direction for the roads to be evaluated by the Engineer. The roads to be evaluated are as follows (see Exhibit A):

- Rancho Sequoia Road from APN 216-382-059 to Alderpoint Road Photos
- Upper Willow Rd from APN 216-382-059 to Rancho Sequoia
- Private Driveway on APN 216-382-059 to Upper Willow Rd

These roadways are being evaluated as part of the Applicant's Cannabis permit referral process. The roadways were evaluated for Category 4 compliance as described in Title III – Land Use and Development, Division II, Fire Safe Regulations (Ordinance) (Exhibit D). The driveway was evaluated for Driveways in accordance with the Ordinance. This analysis performed was in accordance with the Roadway Evaluation Report Instructions provided by Humboldt County Public Works Department.

The existing site conditions for the evaluated roadways in this Technical Memorandum consists of moderate terrain, crosses four Streamside Management Areas (SMA) (Exhibit C), and moderate seismic instability. There are gradual to moderate grades along the roadway evaluation. The Applicant will have one employee onsite and deliveries of supplies to the Applicants facilities will occur once every year.

Evaluation

Rancho Sequoia Road from Upper Willow Dr (Photo 170) to Alderpoint Road (Photos 269-276) (Exhibit B)

This evaluation will apply the Category 4 roadway criteria to Rancho Sequoia

Rd, which is not a County maintained road serving the APN # 216-382-059. Rancho Sequoia Rd varies in width from 14 feet in Photo #112 to 20 feet in Photo 253 with 1-3 foot shoulders. The grades for Rancho Sequoia Rd are all below 16%.

There are sixteen culvert crossings and at the following locations, the culverts are either crushed, clogged, or both:

- Photos – 204, 209/210, 214/217, & 222/224.

There are many curves along Rancho Sequoia Dr and approximately 50% have pullouts associated with them. At the following locations the Engineer recommends additional pullouts to be constructed at curves:

- Photos –176, 191/192, 193/194, 207, 237/238, & 265/266.

There are several abandoned vehicles in the roadway and the Engineer recommends that they be cleared for safe travel. The locations for the abandoned vehicles are as follows:

- Photos –208, 226, 246, & 264.

There is significant rutting in Rancho Sequoia Rd due to poor drainage. And roadside ditches have become clogged or non-existent due to illegal grading activities. This has created erosion issues with water cascading over the road eroding the roadbed and narrowing the travel way at Photo 204. The Engineer recommends fixing these issues and construct waterbars and rolling dips in accordance with Appendix D.

Rancho Sequoia Road has one location between Alderpoint Road and APN 216-382-059 that is a natural location to construct a turnaround, this location is at Photos 177/178. There was one hillside slip at location Photo 219, which the Engineer recommends being stabilized. At location Photo 128, a driveway enters Rancho Sequoia Rd, not at a right angle and at a curve creating a very unsafe stopping sight distance situation. The Engineer recommends that this be addressed at least with signage and possible a mirror at the driveway location.

This portion of Non-County Maintained portion of Price Creek Rd doesn't meet a Category 4 roadway or an Equivalent Category 4 roadway. It is recommended to establish pullouts for curves at the locations identified, verify sizing and fix crushed and clogged culverts, remove the abandoned vehicles, regrade the road to create positive drainage, clean ditches and re-establish roadside ditches and fix the erosion issues identified, construct a paved approach at the intersection of Rancho Sequoia Rd and

Alderpoint Rd in accordance with the Humboldt County Standard (Exhibit F). Additional recommendations would be to construct waterbars and rolling dips in accordance with Appendix D. With these improvements Rancho Sequoia Rd will be safe for vehicular travel.

Upper Willow Rd (Photos 10-22) (Exhibit B)

Upper Willow Rd was evaluated for Category 4 compliance as described in Title III – Land Use and Development, Division II, Fire Safe Regulations.

The Upper Willow Rd for APN 216-382-059 generally has a width that varies from 12 feet to 13 feet wide with 1-2 foot shoulders. The terrain is moderately hilly, and grades are below 16%.

The Private Access Rd for APN 216-382-059 generally has turnouts at curves and pullouts at strategically placed locations along with turnaround areas.

This roadway does not meet a Category 4 Roadway. The Engineer recommends regrading the Private Access Rd and construct rolling dips and water bars in accordance with Appendix D.

Private Driveway (Photos 1-9) (Exhibit B)

The of Private Driveway was evaluated for Category 1 compliance as described in Title III – Land Use and Development, Division II, Fire Safe Regulations.

The Private Driveway for APN 216-382-035 generally has a width that varies from 11 feet to 15 feet wide with 1-2 foot shoulders. The terrain is hilly and most grades are above 16%. In areas that are steeper than 16%, the Engineer does not recommend paving or changing grades because of the short distances involved and negative environmental impacts that can occur due to construction activities. The Engineer does recommend creating a hard surface with dry lime, which will not create any negative environmental impacts due to runoff since a lime road base is permeable.

The Private Driveway for APN 216-382-059 generally has turnouts at curves and pullouts at strategically placed locations along with turnaround areas.

This roadway does not meet a Category 1 Roadway. The Engineer only recommends regrading the driveway, applying a dry lime treatment to the driveway for a hard driving surface due to steep grades, and construct rolling dips and water bars in accordance with Appendix D.

Report Completed By
David Nicoletti PE:

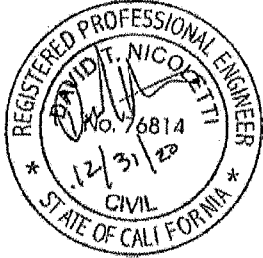

Exhibit A

Exhibit A - Overall Map

APN 216-382-059
APPS 12628

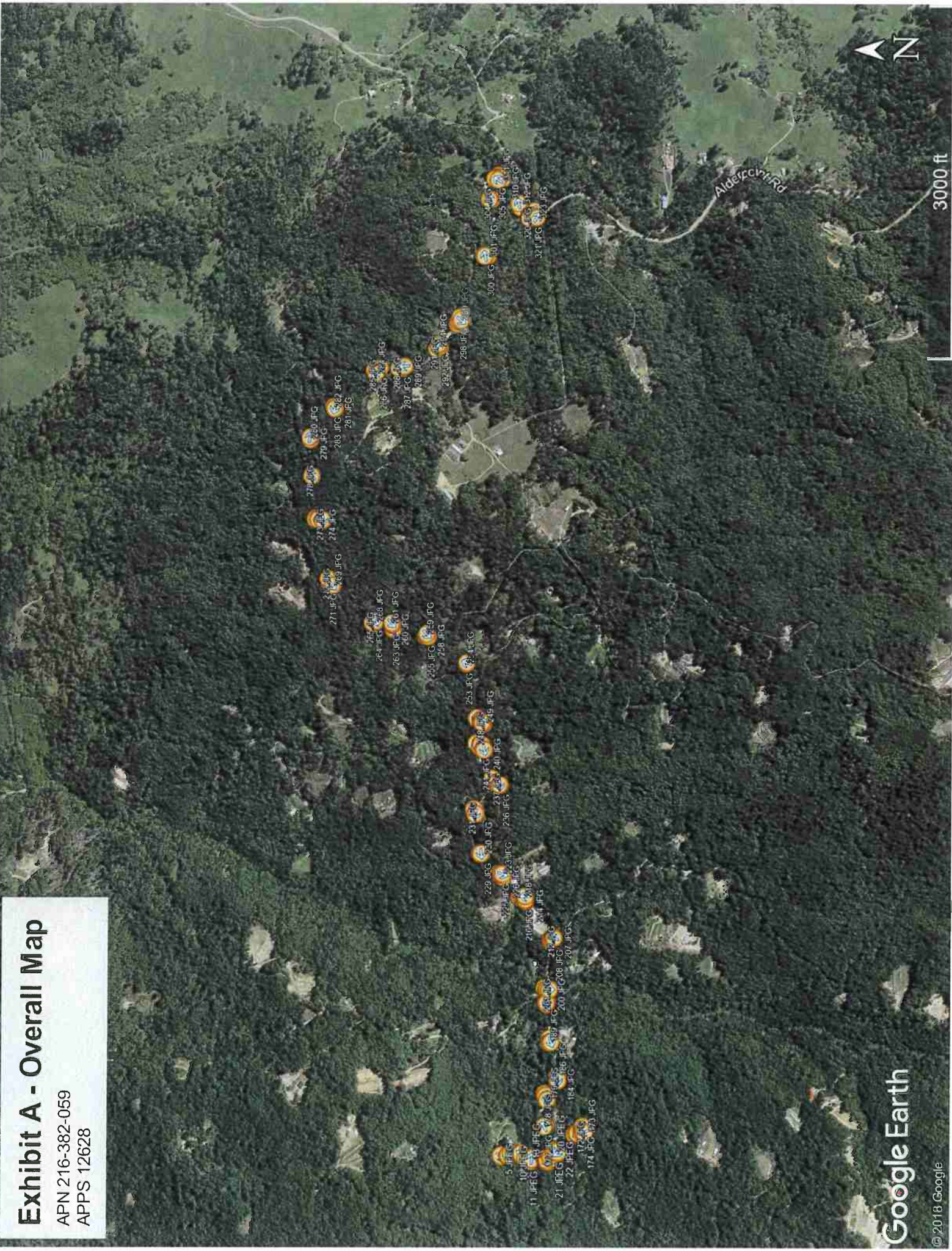

Exhibit A - Photos 166-218

APN #216-382-059

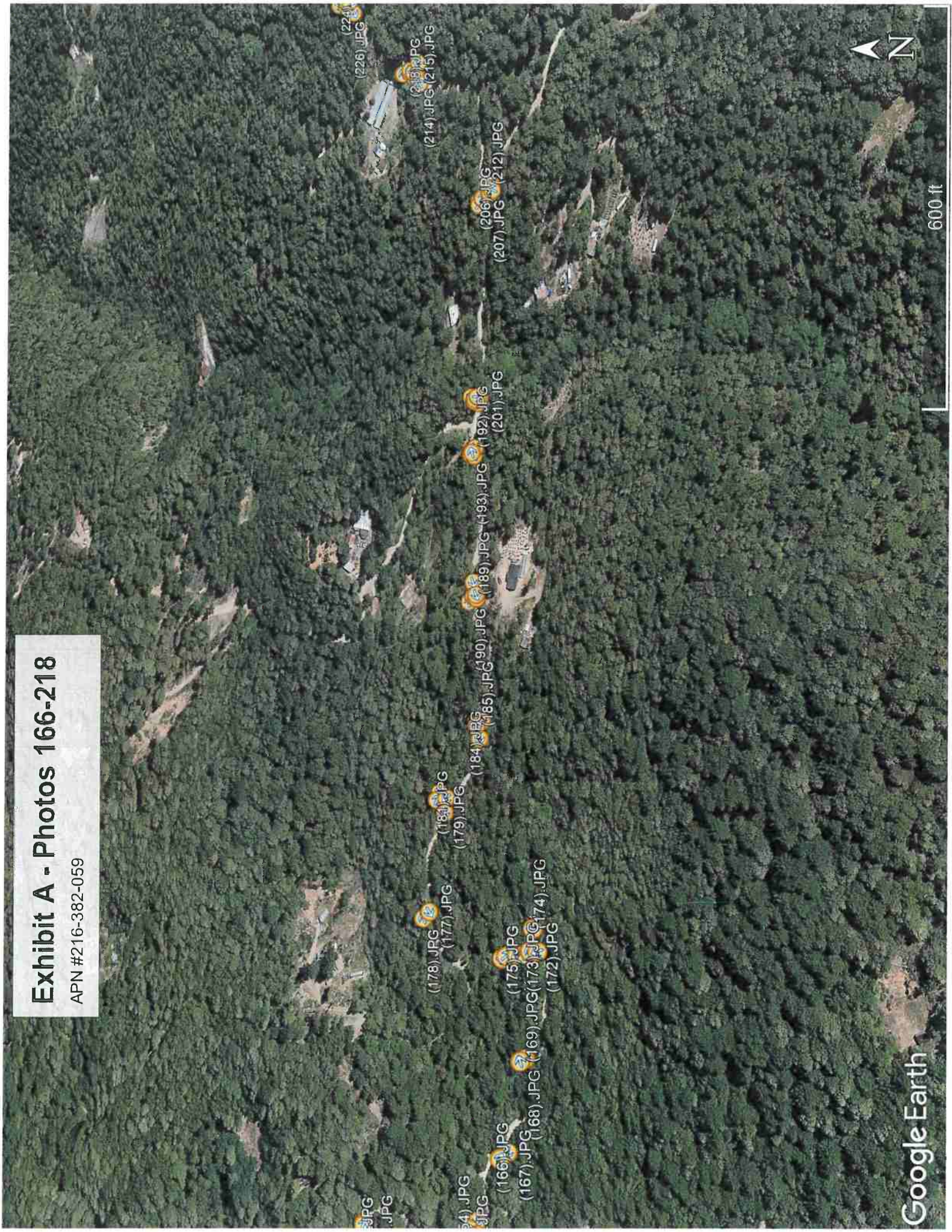

Exhibit A - Photos 219-272

APN #216-382-059



Exhibit A - Photos 273-299

APN #216-382-059

(273).JPG (274).JPG

(278).JPG

(279).JPG (280).JPG

(283).JPG (281).JPG

(284).JPG

(286).JPG

(288).JPG (287).JPG

(289).JPG

(291).JPG

(292).JPG (294).JPG

(297).JPG

(298).JPG (299).JPG

Google Earth

© 2018 Google



600 ft



Exhibit A - Photos 300-325 (Alderpoint Rd)

APN #216-382-059



(301).JPG

(302).JPG

(303).JPG

(307).JPG

(311).JPG

(309).JPG

(310).JPG

(314).JPG

(312).JPG

(313).JPG

(320).JPG

(321).JPG

(325).JPG

(322).JPG

(323).JPG



400 ft

Upper Willow Rd

APN 216-382-059
APPS 12628



Exhibit B



Photo #140, location 36 looking east on Rancho Sequoia Dr.



Photo #141, location 37 looking south on Rancho Sequoia Dr.



Photo #142, location 37 looking east on Rancho Sequoia Dr.



Photo #143, location 37 north side road 18" cpp inlet.



Photo #144, location 37 looking north on Rancho Sequoia Dr.



Photo #145, location 37 south side road 18" cpp outlet.



Photo #146, location 37 looking north on Rancho Sequoia Dr.



Photo #147, location 37 looking south on Rancho Sequoia Dr.



Photo #148, location 38 looking west on Rancho Sequoia Dr.



Photo #149, location 38 looking east on Rancho Sequoia Dr.



Photo #150, location 39 looking north west on Rancho Sequoia Dr.



Photo #151, location 39 looking south east on Rancho Sequoia Dr.



Photo #152, location 39 looking north on Rancho Sequoia Dr.



Photo #153, location 39 road width 17.6'.



Photo #154, location 39 longitudinal slope = 6.8%.



Photo #155, location 40 looking west on Rancho Sequoia Dr.



Photo #156, location 40 looking east on Rancho Sequoia Dr.



Photo #157, location 40 looking west on Rancho Sequoia Dr.



Photo #158, location 41 looking east on Rancho Sequoia Dr.



Photo #159, location 41 looking west on Rancho Sequoia Dr.

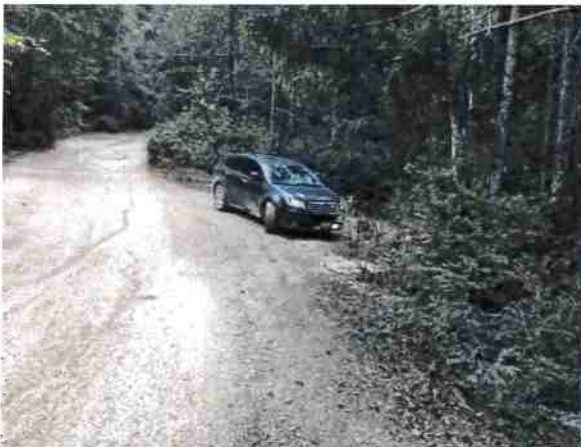

Photo #160, location 41 looking west on Rancho Sequoia Dr.



Photo #161, location 41 north end of 18" cpp Inlet.



Photo #162, location 41 south end of 18" cpp outlet.



Photo #163, location 42 looking west on Rancho Sequoia Dr.



Photo #164, location 42 looking east on Rancho Sequoia Dr.



Photo #165, location 42 looking east on Rancho Sequoia Dr.



Photo #166, location 42 road width 14.3'.



Photo #167, location 42 longitudinal slope = 5.7%.



Photo #168, location 43 looking north west on Rancho Sequoia Dr.



Photo #169, location 44 looking east on Rancho Sequoia Dr.



Photo #170, location 43 west 18" cmp inlet.



Photo #171, location 43 east 18" cmp outlet.



Photo #172, location 43 looking east on Rancho Sequoia Dr.



Photo #173, location 44 looking west on Rancho Sequoia Dr.



Photo #174, location 44 north 18" cmp inlet



Photo #175, location 44 south 18" cmp outlet



Photo #176, location 44 looking east on Rancho Sequoia Dr.



Photo #177, location 44 looking south east on Rancho Sequoia Dr.



Photo #178, location 44 looking south on Rancho Sequoia Dr.



Photo #179, location 44 looking east on Rancho Sequoia Dr.



Photo #180, location 44 looking west on Rancho Sequoia Dr.



Photo #181, location 45 looking south west on Rancho Sequoia Dr.



Photo #182, location 45 looking north east on Rancho Sequoia Dr.



Photo #183, location 45 looking north east on Rancho Sequoia Dr.



Photo #184, location 45 south east side of road near 18" cmp inlet.



Photo #185, location 45 north east side of road near 18" cmp inlet.



Photo #186, location 45 north west side of road near 18" cmp outlet.



Photo #187, location 45 looking north east on Rancho Sequoia Dr.



Photo #188, location 46 looking south west on Rancho Sequoia Dr.

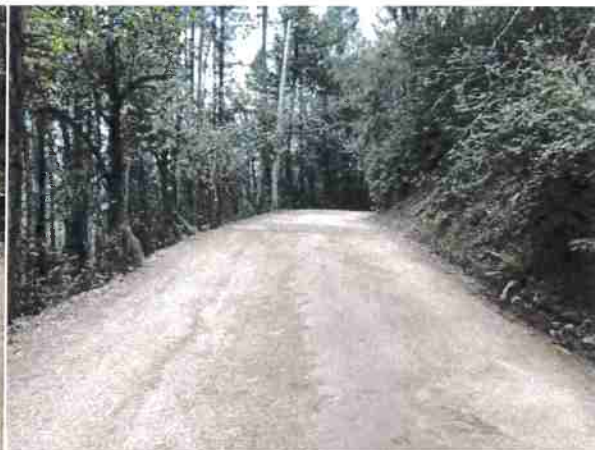

Photo #189, location 46 looking north east on Rancho Sequoia Dr.



Photo #190, location 46 looking south west on Rancho Sequoia Dr.

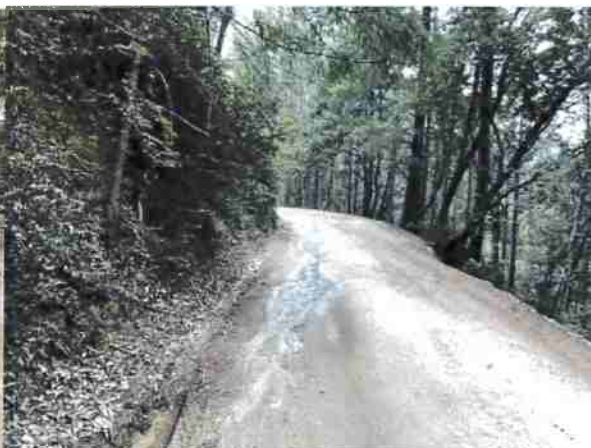

Photo #191, location 47 looking west on Rancho Sequoia Dr.



Photo #192, location 48 looking west on Rancho Sequoia Dr.



Photo #193, location 48 looking south east on Rancho Sequoia Dr.



Photo #194, location 49 looking west on Rancho Sequoia Dr.



Photo #195, location 49 Inorth end 18" cmp inlet.



Photo #196, location 49 south end 18" cmp outlet.



Photo #197, location 49 looking north west on Rancho Sequoia Dr.



Photo #198, location 49 looking west on Rancho Sequoia Dr.



Photo #199, location 49 looking north east on Rancho Sequoia Dr.



Photo #200, location 49 looking east on Rancho Sequoia Dr.



Photo #201, location 50 looking west on Rancho Sequoia Dr.



Photo #203, location 50 south side of road 18" cmp inlet.



Photo #204, location 50 north side of road 18" cmp outlet.



Photo #205, location 50 north side of road 18" cmp outlet.



Photo #206, location 50 road width = 16'.



Photo #207, location 51 looking west on Rancho Sequoia Dr.



Photo #208, location 51 looking east on Rancho Sequoia Dr.



Photo #209, location 51 south side road 18" cmp outlet.



Photo #210, location 51 north side road 18" cmp inlet.



Photo #211, location 52 looking west on Rancho Sequoia Dr.



Photo #212, location 52 looking north east on Rancho Sequoia Dr.



Photo #213, location 53 looking south west on Rancho Sequoia Dr.



Photo #214, location 53 north side of road 18" cmp inlet.



Photo #215, location 53 looking north on Rancho Sequoia Dr.



Photo #216, location 53 south side of road 18" cmp outlet.



Photo #217, location 53 south side of road 18" cmp outlet.



Photo #218, location 53 looking south on Rancho Sequoia Dr.



Photo #219, location 54 looking south on Rancho Sequoia Dr.



Photo #220, location 54 looking north on Rancho Sequoia Dr.

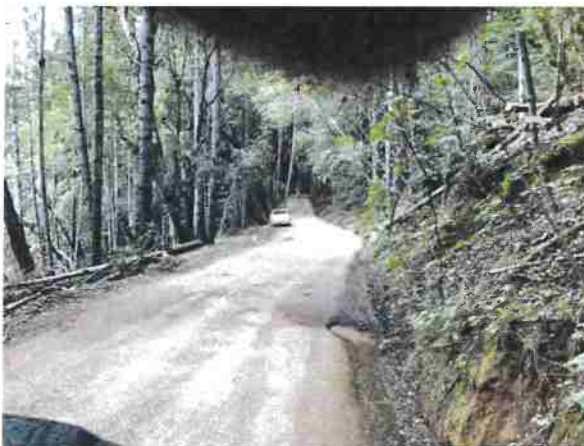

Photo #221, location 54 looking north on Rancho Sequoia Dr.



Photo #222, location 55 south side of road 18" cmp inlet.



Photo #223, location 55 looking north on Rancho Sequoia Dr.



Photo #224, location 55 north side of road 18" cmp outlet.



Photo #225, location 55 north side of road 18”
cmp outlet.



Photo #226, location 55 looking north on
Rancho Sequoia Dr.



Photo #227, location 56 looking south west on
Rancho Sequoia Dr.



Photo #228, location 56 looking north west on
Rancho Sequoia Dr.



Photo #229, location 56 looking east on
Rancho Sequoia Dr.



Photo #230, location 56 looking east on
Rancho Sequoia Dr.



Photo #231, location 57 looking west on Rancho Sequoia Dr.



Photo #232, location 57 looking east on Rancho Sequoia Dr.



Photo #233, location 57 looking east on Rancho Sequoia Dr.



Photo #234, location 57 looking west on Rancho Sequoia Dr.



Photo #235, location 58 looking east on Rancho Sequoia Dr.



Photo #236, location 59 looking west on Rancho Sequoia Dr.



Photo #237, location 59 looking west on Rancho Sequoia Dr.



Photo #238, location 60 looking west on Rancho Sequoia Dr.



Photo #239, location 60 looking east on Rancho Sequoia Dr.



Photo #240, location 61 looking north west on Rancho Sequoia Dr.



Photo #241, location 61 looking south east on Rancho Sequoia Dr.



Photo #242, location 63 looking north west on Rancho Sequoia Dr.



Photo #243, location 62 looking south on Rancho Sequoia Dr.



Photo #244, location 62 looking north on Rancho Sequoia Dr.

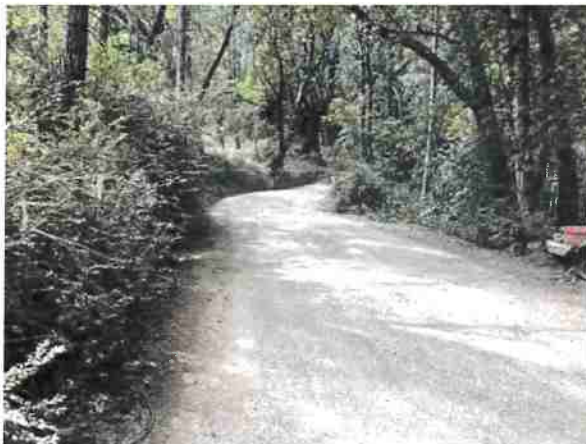

Photo #245, location 63 looking west on Rancho Sequoia Dr.



Photo #246, location 63 looking north west on Rancho Sequoia Dr.



Photo #247, location 63 looking east on Rancho Sequoia Dr.



Photo #248, location 63 looking west on Rancho Sequoia Dr.



Photo #249, location 64 looking west on Rancho Sequoia Dr.



Photo #250, location 64 looking east on Rancho Sequoia Dr.



Photo #251, location 64 looking east on Rancho Sequoia Dr.



Photo #252, location 64 longitudinal slope = 6.0%.



Photo #253, location 64 road width = 19.8'.

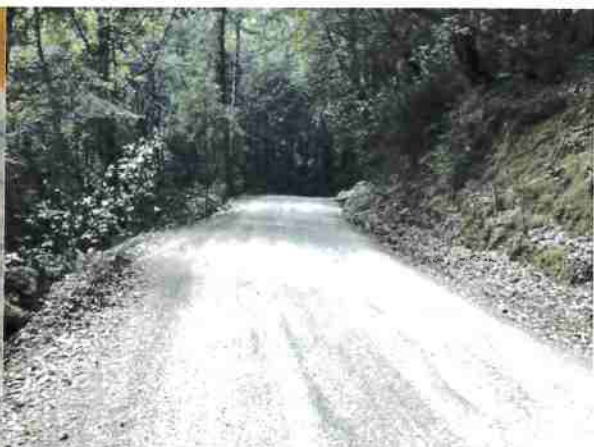

Photo #254, location 65 looking east on Rancho Sequoia Dr.



Photo #255, location 65 looking east on Rancho Sequoia Dr.



Photo #256, location 65 looking west on Rancho Sequoia Dr.



Photo #257, location 66 looking east on Rancho Sequoia Dr.



Photo #258, location 66 looking west on Rancho Sequoia Dr.



Photo #259, location 66 looking east on Rancho Sequoia Dr.



Photo #260, location 67 looking west on Rancho Sequoia Dr.



Photo #261, location 67 looking south on Rancho Sequoia Dr.



Photo #262, location 67 looking north on Rancho Sequoia Dr.



Photo #263, location 67 looking south west on Rancho Sequoia Dr.



Photo #264, location 67 looking north east on Rancho Sequoia Dr.



Photo #265, location 68 looking east on Rancho Sequoia Dr.



Photo #266, location 68 looking west on Rancho Sequoia Dr.



Photo #267, location 68 looking east on Rancho Sequoia Dr.



Photo #268, location 69 looking east on Rancho Sequoia Dr.



Photo #269, location 69 Rancho Sequoia Dr. and Alderpoint Rd.



Photo #270, location 69 Rancho Sequoia Dr. and Alderpoint Rd.



Photo #271, location 69 Rancho Sequoia Dr. and Alderpoint Rd.



Photo #272, location 69 Rancho Sequoia Dr. and Alderpoint Rd.



Photo #273, location 69 Rancho Sequoia Dr. and Alderpoint Rd.



Photo #274, location 69 Rancho Sequoia Dr. and Alderpoint Dr.



Photo #275, location 69 west end of 30" cmp outlet.



Photo #276, location 69 east end of 30" cmp inlet.

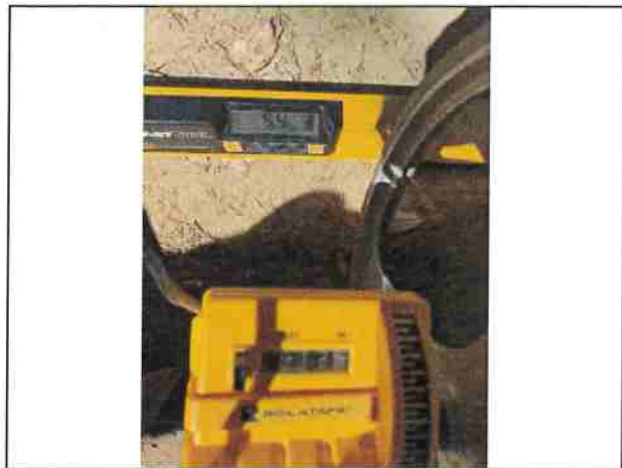

Photo #19 Upper Willow Rd Slope 5.4% Width 12'9"

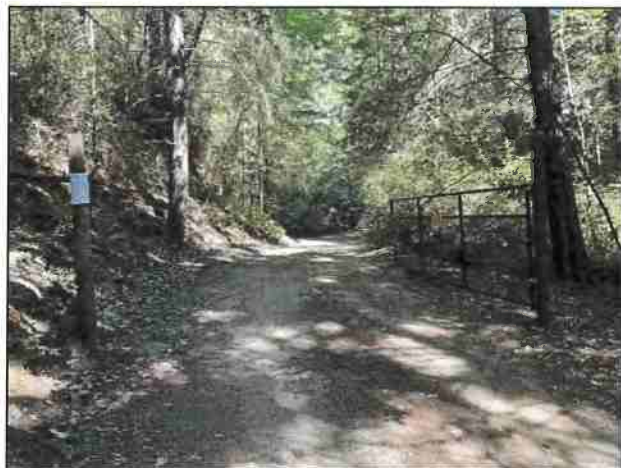

Photo #20 Upper Willow Rd @ Curve w/ Pullout & Gate Looking NW



Photo # 21 Upper Willow Rd Looking SW Towards Rancho Sequoia



Photo # Upper Willow Rd Gate Width 14'0"

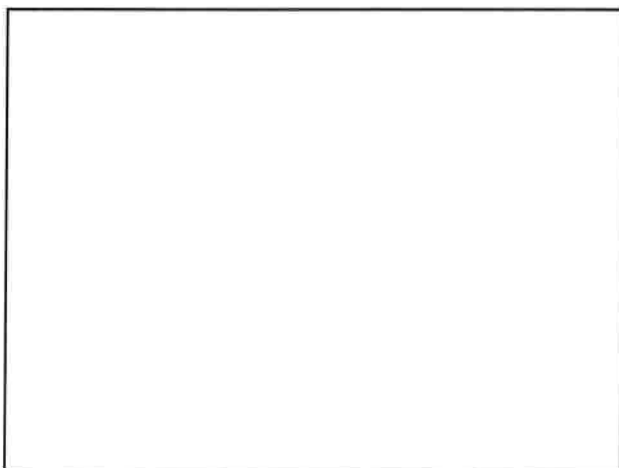

Photo #

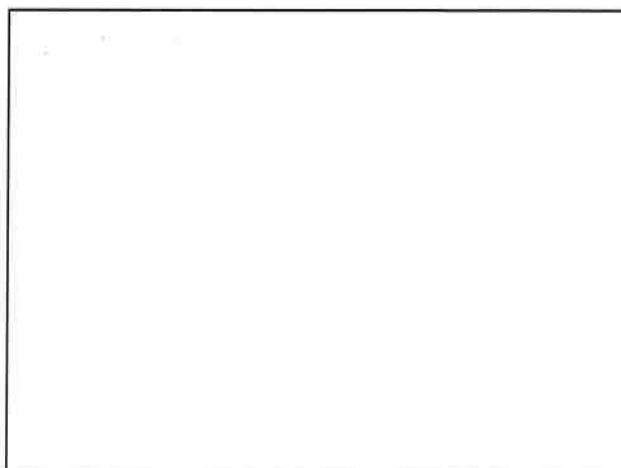

Photo #

Exhibit C

Exhibit D

TITLE III - LAND USE AND DEVELOPMENT

DIVISION 11

FIRE SAFE REGULATIONS

Chapter 1 - Administration

- § 3111-1. Title.
- § 3111-2. Purpose.
- § 3111-3. Scope.
- § 3111-4. Provisions for Application of These Regulations.
- § 3111-5. Inspection Authority.
- § 3111-6. Inspections.
- § 3111-7. Exceptions - Intent.
- § 3111-8. Exceptions to Standards.
- § 3111-9. Requests for Exceptions.
- § 3111-10. Appeals.
- § 3111-11. Definitions.
- § 3111-12. Distance Measurements.
- § 3111-13. Maintenance of Defensible Space Measures.

Chapter 2 - Emergency Access

- § 3112-1. Road and Driveway Access - Intent.
- § 3112-2. Application of Design Standards.
- § 3112-3. Road Width.
- § 3112-4. Roadway Surface.
- § 3112-5. Roadway Grades.
- § 3112-6. Roadway Radius.
- § 3112-7. Roadway Turnarounds.
- § 3112-8. Roadway Turnouts.
- § 3112-9. Roadway Structures.
- § 3112-10. One-Way Roads.
- § 3112-11. Dead-End Roads.
- § 3112-12. Driveways.
- § 3112-13. Gate Entrances.

Chapter 3 - Signing and Building Numbers

- § 3113-1. Signing and Building Numbering - Intent.
- § 3113-2. Size of Letters, Numbers and Symbols for Street and Road Signs.
- § 3113-3. Visibility and Legibility of Street and Road Signs.
- § 3113-4. Height of Street and Road Signs.
- § 3113-5. Names and Numbers on Street and Road Signs.
- § 3113-6. Intersecting Roads, Streets and Private Lanes.
- § 3113-7. Signs Identifying Traffic Access Limitation.
- § 3113-8. Installation of Road, Street and Private Lane Signs.
- § 3113-9. Addresses for Buildings.
- § 3113-10. Size of Letters, Numbers and Symbols.
- § 3113-11. Installation, Location and Visibility of Addresses.

Chapter 4 - Emergency Water Standards

- § 3114-1. Water Standards - Intent.
- § 3114-2. Application.
- § 3114-3. General Standards.
- § 3114-4. Hydrant/Fire Valve.
- § 3114-5. Signing of Water Sources

Chapter 5 - Fuel Modification Standards

- § 3115-1. Fuel Modification - Intent.
- § 3115-2. Setback for Structure Defensible Space.
- § 3115-3. Disposal of Flammable Vegetation and Fuels.
- § 3115-4. Greenbelts.

Chapter 6 - Enforcement

- § 3116-1. Violation.

TITLE III - LAND USE AND DEVELOPMENT

DIVISION 11

FIRE SAFE REGULATIONS

CHAPTER 1

ADMINISTRATION

3111-1. TITLE.

These regulations shall be known as the "SRA Fire Safe Regulations" and shall constitute the basic wildland fire protection standards of the County for lands within State Responsibility Areas (SRA). (Ord. 1952, § 1, 12/17/1991)

3111-2. PURPOSE.

These regulations have been prepared and adopted for the purpose of establishing minimum wildlife protection standards in conjunction with building, construction and development in SRA. These regulations constitute local alternative standards as authorized by Section 4290 of the Public Resources Code. The future design and construction of structures, subdivisions and developments in SRA shall provide for basic emergency access and perimeter wildlife protection measures as specified in the following sections. These measures shall provide for emergency access; signing and building numbering; private water supply reserves for emergency fire use; and vegetation modification. The fire protection standards which follow shall specify the minimums for such measures. (Ord. 1952, § 1, 12/17/1991)

3111-3. SCOPE.

(a) These regulations shall apply as appropriate to all of the following activities which are approved in the SRA after January 1, 1992: (Ord. 1952, § 1, 12/17/1991)

- (1) the creation of new parcels, excluding lot line adjustments as specified in Government Code (GC) Section 66412 (d); (Ord. 1952, § 1, 12/17/1991)
- (2) new construction, not relating to an existing structure, which requires a building permit; (Ord. 1952, § 1, 12/17/1991)
- (3) land use or development which requires a use permit; (Ord. 1952, § 1, 12/17/1991)
- (4) the siting of manufactured homes; and (Ord. 1952, § 1, 12/17/1991)
- (5) new road construction, including construction of a road that does not currently exist, or an extension of an existing road. (Ord. 1952, § 1, 12/17/1991)

(b) Notwithstanding paragraph (a) of this section, these regulations shall not apply to: (Ord. 1952, § 1, 12/17/1991)

- (1) enlargement, alteration, repair or improvement of any building or structure existing on the effective date of these regulations; (Ord. 1952, § 1, 12/17/1991)
- (2) new construction of accessory structures where the main building exists on the effective date of these regulations; (Ord. 1952, § 1, 12/17/1991)

- (3) land use or development which requires a use permit where the Planning Director and CAL FIRE determines that no increase in fire risk would result from the use or activity (e.g., wetland restoration or fish and wildlife habitat management); (Ord. 1952, § 1, 12/17/1991; amended by Ord. 2540, Section 1, 11/17/2015)
- (4) roads required as a condition of tentative parcel or final maps prior to the effective date of these regulations; roads for agricultural or mining use solely on one ownership; and roads use solely for the management and harvesting of wood products; and (Ord. 1952, § 1, 12/17/1991)
- (5) repair or maintenance of any road, street or private lane existing on the effective date of these regulations. (Ord. 1952, § 1, 12/17/1991)

3111-4. PROVISIONS FOR APPLICATION OF THESE REGULATIONS.

These regulations shall be applied as follows:

- (a) The County shall provide the local CAL FIRE Unit with notice of applications for building permits, tentative parcel maps, tentative maps, and use permits for construction or development within SRA. (Ord. 1952, § 1, 12/17/1991; amended by Ord. 2540, Section 1, 11/17/2015)
- (b) The County shall request CAL FIRE to review and make fire protection recommendations on applicable construction or development permits or maps provided by the County. CAL FIRE shall respond within thirty (30) days of the referral. (Ord. 1952, § 1, 12/17/1991; amended by Ord. 2540, Section 1, 11/17/2015)
- (c) The County shall ensure that the applicable sections of this ordinance become a condition of approval of any applicable construction or development permit or map. (Ord. 1952, § 1, 12/17/1991)
- (d) The application of these regulations shall be confined to the real property that is the subject of the building permit or other grant of land use or development approval by the County, unless otherwise stated. (Ord. 1952, § 1, 12/17/1991)

Nothing contained in these regulations shall be considered as abrogating the provisions of any ordinance, rule or regulation of the state or county, including the provisions of the California Environmental Quality Act (CEQA), which may require the evaluation and mitigation of potential impacts of the project beyond the limits of the real property that is the subject of the building permit or other grant of land use or development approval before the County. (Ord. 1952, § 1, 12/17/1991)

3111-5. INSPECTION AUTHORITY.

- (a) Inspection shall be made pursuant to Section 6 by:
 - (1) the Planning Director or his/her designee, or (Ord. 1952, § 1, 12/17/1991)
 - (2) the Director of the California Department of Forestry and Fire Protection (CAL FIRE) or his/her designee. (Ord. 1952, § 1, 12/17/1991; amended by Ord. 2540, Section 1, 11/17/2015)

(b) The County shall report violations of these regulations to the CAL FIRE Unit headquarters with responsibility for SRA fire protection for the County. (Ord. 1952, § 1, 12/17/1991; amended by Ord. 2540, Section 1, 11/17/2015)

3111-6. INSPECTIONS.

(a) The inspection authority may inspect for compliance with these regulations. When conducted, inspections should occur prior to the following events: (Ord. 1952, § 1, 12/17/1991)

- (1) issuance of a use permit; (Ord. 1952, § 1, 12/17/1991)
- (2) issuance of a Certificate of Occupancy under a building permit; (Ord. 1952, § 1, 12/17/1991)
- (3) recordation of a parcel or final map for a subdivision; (Ord. 1952, § 1, 12/17/1991)
- (4) filing of a notice of completion (other than for a building permit); (Ord. 1952, § 1, 12/17/1991) or
- (5) final inspection of any project or building permit. (Ord. 1952, § 1, 12/17/1991)

(b) It shall be the duty of the holder of the building permit or other permit or map approval issued by the County to notify the County, or CAL FIRE, as appropriate, that the construction and/or improvement required under these regulations is ready for inspection and to assure that the premises will be accessible at the time scheduled for inspection. Inspections shall be requested by the applicant at least forty-eight (48) hours in advance of the intended inspection. (Ord. 1952, § 1, 12/17/1991; amended by Ord. 2540, Section 1, 11/17/2015)

(c) The inspection authority shall notify or inform the permit holder of the day during which the inspection is to be conducted and shall attempt to notify the permit holder if the inspection cannot be made as scheduled. (Ord. 1952, § 1, 12/17/1991)

(d) Annual inspection conducted by CAL FIRE pursuant to Public Resources Code Section 4290 shall to the extent practical include notification as provided in paragraph (c) of this section for inspections which focus on individual parcels and by public notice for area-wide inspections. (Ord. 1952, § 1, 12/17/1991; amended by Ord. 2540, Section 1, 11/17/2015)

3111-7 EXCEPTIONS - INTENT.

The County seeks to protect the intent of the State Fire Safe Regulations while ensuring that no undue hardship occurs at the county level due to conditions peculiar to the County. The exceptions procedure is provided with the intent of ensuring that every individual who is negatively impacted will get a fair hearing before local authorities who are competent to judge the legitimacy of that individual's concerns. The local inspection authority together with the local representative of CAL FIRE is therefor directed to deal with requests for exceptions to the provisions of these regulations on a case by case basis, making a comprehensive review of the circumstances in each case, taking special note of such factors as: (Ord. 1952, § 1, 12/17/1991; amended by Ord. 2540, Section 1, 11/17/2015)

- (a) community standards as expressed in the County' Alternative Owner Building Ordinance; and (Ord. 1952, § 1, 12/17/1991)
- (b) economic factors which may affect the affordability of housing as described in the Housing Element of the County's General Plan. (Ord. 1952, § 1, 12/17/1991)

3111-8. EXCEPTIONS TO STANDARDS.

Upon request by the applicant, exceptions to standards within this ordinance and mitigated practices shall be allowed by the inspection authority, where the exception provides the same overall practical effect as these regulations towards providing defensible space. In evaluating requests for exceptions to standards, the inspection authority shall be guided by Section 3111-7 of these regulations (Intent). (Ord. 1952, § 1, 12/17/1991)

3111-9. REQUESTS FOR EXCEPTIONS.

- (a) An applicant may apply to the Planning Director for an exception to the standards within this ordinance. The application for an exception shall be accompanied by such information as the Planning Department requires and by a fee established by the Board of Supervisors. At minimum, the application shall contain the following information: (Ord. 1952, § 1, 12/17/1991)
- (1) a description of the specific section(s) for which an exception is requested, (Ord. 1952, § 1, 12/17/1991)
 - (2) material facts supporting the contention of the applicant, (Ord. 1952, § 1, 12/17/1991)
 - (3) details of the exception or mitigation measures proposed, and (Ord. 1952, § 1, 12/17/1991)
 - (4) a map showing the proposed location and siting of the exception or mitigation measure(s). (Ord. 1952, § 1, 12/17/1991)
- (b) The Planning Director shall request the California Department of Forestry and Fire Protection (CAL FIRE) to review the exception request. CAL FIRE shall respond within thirty (30) days of the referral with documentation outlining the effects of the requested exception on wildland fire protection. If CAL FIRE does not respond within the time provided, the Planning Director shall assume that CAL FIRE supports the exception. The Planning Director shall not approve an exception request if the recommendation from CDF is for denial. (Ord. 1952, § 1, 12/17/1991; amended by Ord. 2540, Section 1, 11/17/2015)
- (c) The Planning Director shall give written notice of his/her decision to the applicant. Notice shall also be given to any parties requesting such notice and to CAL FIRE. (Ord. 1952, § 1, 12/17/1991; amended by Ord. 2540, Section 1, 11/17/2015)

3111-10. APPEALS.

- (a) Any person aggrieved by the decision of the Planning Director may appeal to the Board of Supervisors. The appeal shall be filed with the Planning Department within ten (10) days of the date of the notice and shall be accompanied by a written statement of the reasons why the decision was in error and by a fee established by the Board of Supervisors. (Ord. 1952, § 1, 12/17/1991)
- (b) The Board of Supervisors shall consider the appeal at the earliest possible date. The decision of the Board of Supervisors is final and binding. (Ord. 1952, § 1, 12/17/1991)
- (c) If an appeal is granted, the Board of Supervisors shall make findings that the decision meets the intent of providing defensible space consistent with these regulations. Such findings shall include reasons for the decision. (Ord. 1952, § 1, 12/17/1991)

- (d) A written copy of the findings adopted under paragraph (c) above shall be provided to the CAL FIRE Unit headquarters that administers SRA fire protection in the County. (Ord. 1952, § 1, 12/17/1991; amended by Ord. 2540, Section 1, 11/17/2015)

3111-11. DEFINITIONS.

Unless the context otherwise requires, the definitions set out in this ordinance shall be used in the interpretation and construction of these regulations. Words used in the present tense shall include the future tense, and in the future tense shall include the present tense; the singular number shall include the plural number, and the plural shall include the singular. (Ord. 1952, § 1, 12/17/1991)

Abatement: For the purpose of this ordinance means the restoration of the specific measure(s) or mitigation required as a condition of the permit, parcel or map approval pursuant to these regulations. (Ord. 1952, § 1, 12/17/1991)

Accessory building: Any building used as an accessory to residential, Commercial, recreational, industrial, or educational purposes as defined in the California Building Code, 2013 Edition, Chapter 3, Group U Occupancy, as amended from time to time by the State, that requires a building permit. (Ord. 1952, § 1, 12/17/1991; amended by Ord. 2540, Section 1, 11/17/2015)

Agriculture: Land used for agricultural uses as defined in Humboldt County Code Section 312-6. (Ord. 1952, § 1, 12/17/1991)

Board: The Humboldt County Board of Supervisors. (Ord. 1952, § 1, 12/17/1991)

Building: Any structure used or intended for supporting or sheltering any use or occupancy that is defined in the California Building Code, 1989 Amendments, Chapter 11, except Group M, Division 1, Occupancy. For the purpose of the ordinance, building includes mobile homes and manufactured homes, churches, and day care facilities. (Ord. 1952, § 1, 12/17/1991)

California Environmental Quality Act (CEQA): Means the California Environmental Quality Act, California Public Resources Code Section 21000 et seq. (Ord. 1952, § 1, 12/17/1991)

CAL FIRE: California Department of Forestry and Fire Protection. (Ord. 1952, § 1, 12/17/1991; amended by Ord. 2540, Section 1, 11/17/2015)

County: The County of Humboldt. (Ord. 1952, § 1, 12/17/1991)

Dead-end road: A road that has only one point of vehicular ingress/egress, including cul-de-sacs and looped roads. (Ord. 1952, § 1, 12/17/1991)

Defensible space: The area within the perimeter of a parcel, development, neighborhood or community where basic wildland fire protection practices and measures are implemented, providing the key point of defense from an approaching wildfire or defense against encroaching wildfires or escaping structure fires. The perimeter used in this regulation is the area encompassing the parcel or parcels proposed for construction and/or development, excluding the physical structure itself. The area is characterized by the establishment and maintenance of emergency vehicle access, emergency water reserves, street names and building identification, and fuel modification measures. (Ord. 1952, § 1, 12/17/1991)

Development: As defined in Section 66418.1 of the California Government Code. (Ord. 1952, § 1, 12/17/1991)

Director of Public Works: The Director of the Department of Public Works or his/her designee. (Ord. 1952, § 1, 12/17/1991)

Drafting: The transfer of water from the source, usually a tank or pond, to the fire engine or water tender where the head pressure of the water source on the hydrant is insufficient to perform the operation without suction provided by a pump on the fire apparatus. (Added by Ord. 2540, Section 1, 11/17/2015)

Driveway: A vehicular access that serves no more than two buildings, with no more than three dwelling units on a single parcel, and any number of accessory buildings. (Ord. 1952, § 1, 12/17/1991)

Dwelling unit: Any building or portion thereof which contains living facilities, including provisions for sleeping, eating, cooking and/or sanitation for not more than one family. (Ord. 1952, § 1, 12/17/1991)

Exception: An alternative to the specified standard requested by the applicant that may be necessary due to health, safety, environmental conditions, physical site limitations or other limiting conditions such as recorded historical sites, that provides mitigation of the problem. (Ord. 1952, § 1, 12/17/1991)

Feasible: Means capable of being accomplished in a successful manner within a reasonable period of time, taking into account economic, environmental, legal, social, and technological factors. (Added by Ord. 2540, Section 1, 11/17/2015)

Fire valve: See hydrant. (Ord. 1952, § 1, 12/17/1991)

Fuel modification area: An area where the volume of flammable vegetation has been reduced, providing reduced fire intensity and duration. (Ord. 1952, § 1, 12/17/1991)

Greenbelts: A facility or land-use, designed for a use other than fire protection, which will slow or resist the spread of a wildfire. Includes parking lots, irrigated or landscaped areas, golf courses, parks, playgrounds, maintained vineyards, orchards or annual crops that do not cure in the field. (Ord. 1952, § 1, 12/17/1991)

Hammerhead "T": A roadway that provides a "T" shaped, three-point turnaround space for emergency equipment, being no narrower than the road that serves it. (Ord. 1952, § 1, 12/17/1991; amended by Ord. 2540, Section 1, 11/17/2015)

Hydrant: A valved connection on a water supply/storage system, having at least one 2-1/2 inch outlet, with male American National Fire Hose Screw Threads (NH) used to supply fire apparatus and hose with water. (Ord. 1952, § 1, 12/17/1991)

Local Authority having jurisdiction: This term shall have the following meaning with regard to administration of the following codes and regulations: County Road Manual, the Director of the Department of Public Works; California Building Code, the Chief Building Official; and Uniform Fire Code, the State Fire Marshal or the local fire agency. (Added by Ord. 2540, Section 1, 11/17/2015)

Local fire agency: A local fire organization recognized by the County Local Agency Formation Commission (LAFCO) which has shared responsibility on SRA lands. (Ord. 1952, § 1, 12/17/1991)

Manufactured home: As defined in California Health and Safety Code Sections 18007, 18008, and 199791. (Ord. 1952, § 1, 12/17/1991)

Mountainous Terrain: Any combination of gradients, length of grade, or horizontal or vertical alignment that will cause trucks to operate at very slow speeds for considerable distances or at frequent intervals; generally associated with steep terrain with cross slopes of 30% or greater. (Added by Ord. 2540, Section 1, 11/17/2015)

Occupancy: The purpose for which a building, or part thereof, is used or intended to be used. (Ord. 1952, § 1, 12/17/1991)

One-way road: A minimum of one traffic lane width designed for traffic flow in one direction only. (Ord. 1952, § 1, 12/17/1991)

Planning Director: Director of the Planning and Building Department or his/her designee. (Ord. 1952, § 1, 12/17/1991)

Roads, streets, private lanes: Vehicular access to more than one parcel; access to any industrial or commercial occupancy; or vehicular access to a single parcel with more than two buildings or four or more dwellings units. (Ord. 1952, § 1, 12/17/1991)

Roadway: Any surface designed, improved, or ordinarily used for vehicle travel. (Ord. 1952, § 1, 12/17/1991)

Roadway structures: Bridges, culverts, and other appurtenant structures which supplement the roadway bed or shoulders. (Ord. 1952, § 1, 12/17/1991)

Same practical effect: As used in this ordinance, means an exception or alternative with the capability of applying accepted wildland fire suppression strategies and tactics, and provisions for firefighter safety, including: (Ord. 1952, § 1, 12/17/1991)

- (a) access for emergency wildland fire equipment, (Ord. 1952, § 1, 12/17/1991)
- (b) safe civilian evacuation, (Ord. 1952, § 1, 12/17/1991)
- (c) signing that avoids delays in emergency equipment response, (Ord. 1952, § 1, 12/17/1991)
- (d) available and accessible water to effectively attack wildfire or defend a structure from wildfire, and (Ord. 1952, § 1, 12/17/1991)
- (e) fuel modification sufficient for civilian and firefighter safety. (Ord. 1952, § 1, 12/17/1991)

Shoulder: Roadbed or surface adjacent to the traffic lane. (Ord. 1952, § 1, 12/17/1991)

State Board of Forestry (SBOF): A nine member board, appointed by the Governor, which is responsible for developing the general forest policy of the state, for determining the guidance policies of the Department of Forestry and Fire Protection, and for representing the state's interest in federal land in California. (Ord. 1952, § 1, 12/17/1991)

State Responsibility Area (SRA): As defined in Public Resources Code Sections 4126-4127; and the California Code of Regulations, Title 14, Division 1.5, Chapter 7, Article 1, Sections 1220-1220.5. (Ord. 1952, § 1, 12/17/1991)

Structure: That which is built or constructed, an edifice or building of any kind, or any piece of work artificially built up or composed of parts joined together in some definite manner. (Ord. 1952, § 1, 12/17/1991)

Subdivision: As defined in Section 66424 of the California Government Code. (Ord. 1952, § 1, 12/17/1991)

Traffic lane: The portion of the roadway that provides a single line of vehicle travel, excluding striping, where present. (Ord. 1952, § 1, 12/17/1991; amended by Ord. 2540, Section 1, 11/17/2015)

Turnaround: A roadway, unobstructed by parking, which allows for a safe opposite change of direction for emergency equipment. Design of such area may be a hammerhead "T", Slip "T" or terminus bulb. (Ord. 1952, § 1, 12/17/1991; amended by Ord. 2540, Section 1, 11/17/2015)

Turnouts: A widening in a roadway to allow vehicles to pass. (Ord. 1952, § 1, 12/17/1991)

Vertical clearance: The minimum specified height of a bridge or overhead projection above the roadway. (Ord. 1952, § 1, 12/17/1991)

Wildfire: As defined in California Public Resources Code Sections 4103 and 4104. (Ord. 1952, § 1, 12/17/1991)

3111-12. DISTANCE MEASUREMENTS.

All specified or referenced distances are measured along the ground surface, unless otherwise stated. (Ord. 1952, § 1, 12/17/1991)

3111-13. MAINTENANCE OF DEFENSIBLE SPACE MEASURES.

(a) To ensure continued maintenance of properties in conformance with these standards and measures and to assure continued availability, access, and utilization of the defensible space provided for in these standards during a wildfire, provisions for annual maintenance shall be included in the development plans and/or shall be provided as a condition of approving any activity subject to these regulations. Provisions deemed to satisfy this requirement include but are not limited to: (Ord. 1952, § 1, 12/17/1991)

- (1) establishment of a County Service Area (CSA) for the subdivision prior to map recordation; (Ord. 1952, § 1, 12/17/1991)
- (2) development of a binding maintenance association or similar agreement between affected property owners formed for the subdivision prior to map recordation; (Ord. 1952, § 1, 12/17/1991)
- (3) recordation of binding Covenants, Conditions, and Restrictions (CC&R) for maintenance of individual measures which are enforceable against the property; or (Ord. 1952, § 1, 12/17/1991)
- (4) recordation of a Notice of Requirement for Maintenance against the real property by the County prior to issuance of a building permit or as a condition of a initiating a use authorized under a use permit. (Ord. 1952, § 1, 12/17/1991)

(b) The inspection authority may conduct inspections to ensure compliance with the standards as set forth in the development plans and/or conditions of permit, parcel or map approval. Inspections should be conducted in accordance with Section 3111-6, paragraph (d) of these regulations. Violation of these regulations shall be subject to the penalties as set forth in Section 3116-1 of this ordinance. (Ord. 1952, § 1, 12/17/1991)

CHAPTER 2

EMERGENCY ACCESS

3112-1. ROAD AND DRIVEWAY ACCESS - INTENT.

Road and street networks, whether public or private, unless exempted under Section 3111-3(b), shall provide for safe access for emergency wildland fire equipment and civilian evacuation concurrently, and shall provide unobstructed traffic circulation during a wildfire emergency consistent with Sections 3112-2 through 3112-13. (Ord. 1952, § 1, 12/17/1991)

3112-2. APPLICATION OF DESIGN STANDARDS.

The design and improvement standards as referenced in these regulations shall be those as set forth in the Appendix to Title III, Division 2, of the Humboldt County Code, and in the County Roadway Design Manual. Application of these design and improvement standards shall be consistent with the intent as prescribed in Section 3112-1, and shall be based upon: (Ord. 1952, § 1, 12/17/1991)

- (a) legal requirements, (Ord. 1952, § 1, 12/17/1991)
- (b) sound engineering principles and practices and engineering geological evaluation of necessary, (Ord. 1952, § 1, 12/17/1991)
- (c) traffic safety considerations, (Ord. 1952, § 1, 12/17/1991)
- (d) economy of design and maintenance, and (Ord. 1952, § 1, 12/17/1991)
- (e) allowance for the special nature of Humboldt County roads and traffic problems. (Ord. 1952, § 1, 12/17/1991)

Interpretation of these standards shall be provided by the Director of Public Works. (Ord. 1952, § 1, 12/17/1991)

3112-3. ROAD WIDTH.

All roads shall be constructed to a minimum Road Category 4 road standard of two ten (10) foot traffic lanes, not including shoulders, capable of providing for two-way traffic flow to support emergency vehicle and civilian egress. This standard may be modified where an exception has been granted pursuant to Sections 3111-7 through 3111-10 of this ordinance, and the development is made subject to the following provisions. (Ord. 1952, § 1, 12/17/1991; amended by Ord. 2540, Section 1, 11/17/2015)

- (a) A traffic lane meeting the standard for Road Category 2 (12 feet) shall be considered as meeting the requirements of this section for a single lot division into two (2) parcels, where all the following conditions are met: (Ord. 1952, § 1, 12/17/1991; amended by Ord. 2540, Section 1, 11/17/2015)
 - (1) The subdivision is conditioned so as to limit site development as follows: (Ord. 1952, § 1, 12/17/1991)

For a parcel or parcels having a minimum parcel size of less than 20 acres, not more than one (1) dwelling unit shall be permitted for each parcel. (Ord. 1952, § 1, 12/17/1991)

For a parcel or parcels having a minimum parcel size of 20 acres or more, not more than two (2) dwelling units shall be permitted for each parcel. (Ord. 1952, § 1, 12/17/1991)

- (2) Rights to further subdivide the parcels created by the land division would be conveyed to the county until such time as the full road segment was improved to a minimum of Road Category 3 or 4 for traffic lane, as appropriate. (Ord. 1952, § 1, 12/17/1991)
 - (3) Inter-visible turnouts are installed in conformance Section 3112-8 of these regulations. (Ord. 1952, § 1, 12/17/1991)
- (b) In mountainous terrain and/or where geologic or other natural features make infeasible full development of two ten (10) foot wide traffic lanes, a traffic lane meeting the standard for Road Category 3 (16 feet) shall be considered as meeting the requirements of this section for subdivisions of three (3) to eight (8) parcels, where all the following conditions are met: (Ord. 1952, § 1, 12/17/1991; amended by Ord. 2540, Section 1, 11/17/2015)
- (1) The subdivision is conditioned so as to limit site development as follows: (Ord. 1952, § 1, 12/17/1991)

For a parcel or parcels having a minimum parcel size of less than 20 acres, not more than one (1) dwelling unit shall be permitted for each parcel. (Ord. 1952, § 1, 12/17/1991)

For a parcel or parcels having minimum parcel size of 20 acres, not more than two (2) dwelling units shall be permitted for each parcel. (Ord. 1952, § 1, 12/17/1991)
 - (2) Rights to further subdivide the parcels created by the subdivision would be conveyed to the County until such time as the full road segment was improved to a minimum of Road Category 4 for a traffic lane. (Ord. 1952, § 1, 12/17/1991; amended by Ord. 2540, Section 1, 11/17/2015)
 - (3) The roadbed width shall include a minimum of two-foot (2') wide bladed shoulders on each side of the traffic lane. (Ord. 1952, § 1, 12/17/1991; amended by Ord. 2540, Section 1, 11/17/2015)
- (c) In mountainous terrain and/or where geologic or other natural features make infeasible full development of two ten (10) foot wide traffic lanes, a traffic lane meeting the standard for Road Category 3 (16 feet) shall be considered as meeting the requirements of this section for subdivisions of not more than nineteen (19) parcels, where all the following conditions are met: (Ord. 1952, § 1, 12/17/1991; amended by Ord. 2540, Section 1, 11/17/2015)
- (1) The requirements of Section 3112-3(b) are satisfied. (Ord. 1952, § 1, 12/17/1991)
 - (2) The minimum parcel size for the subdivision is forty (40) acres or larger. (Ord. 1952, § 1, 12/17/1991)

3112-4. ROADWAY SURFACE.

The surface of all roadways shall provide unobstructed access to conventional drive vehicles, including sedans and fire engines. The surface shall conform to the standards of a Road Category 4 roadway. Where Road Category 2 or 3 has been approved pursuant to Section 3112-3, the surface shall conform to the standards for these categories, as appropriate. Roadways shall be designed and maintained to support the imposed load of fire apparatus weighing at least 75,000 pounds. Ord. 1952, § 1, 12/17/1991; amended by Ord. 2540, Section 1, 11/17/2015)

3112-5. ROADWAY GRADES.

The grade for all roads, streets, and private lanes shall conform to the standards for Road Category 4. The grade for driveways shall conform to the standards for Road Category 1. No roadway grade in excess of 16 percent shall be permitted unless it has been demonstrated to be in conformance with the County Roadway Design Manual. (Ord. 1952, § 1, 12/17/1991)

3112-6. ROADWAY RADIUS.

- (a) The roadway radius for all roads, and private lanes shall conform to the standards for Road Category 4. The minimum roadway radius for driveways shall conform to the standards for Road Category 1. No roadway shall have a horizontal inside radius of curvature of less than 50 feet unless it has been demonstrated to be in conformance with the County Roadway Design Manual. (Ord. 1952, § 1, 12/17/1991)
- (b) Curve alignments shall provide for curve widening on low radius curves to compensate for off tracking characteristics of trucks and trailers. Additional surface width of four (4) feet shall be added to curves of 50-100 feet radius; two (2) feet to those from 100-200 feet. Design of curve alignments shall be in conformance with the County Design Manual. (Ord. 1952, § 1, 12/17/1991)
- (c) The length of vertical curves in roadways, exclusive of gutters, ditches, and drainage structures designed to hold or divert water, shall not be less than 100 feet. Design of vertical curves shall be in conformance with the County Roadway Design Manual. (Ord. 1952, § 1, 12/17/1991)

3112-7. ROADWAY TURNAROUNDS.

Turnarounds are required on driveways and dead-end roads as specified in these regulations. The minimum turning radius for a turnaround shall be 40 feet from the center line of the road, not including the parking lane. If a hammerhead "T" is used, the top of the "T" shall be a minimum of 60 feet in length. If a slip "T" design is used, the projection shall have a minimum depth of forty (40) feet. Turnaround designs shall conform to the diagrams below in Figures 3112-7A, 3112-7B and 3112-7C, as applicable. (Ord. 1952, § 1, 12/17/1991; amended by Ord. 2540, Section 1, 11/17/2015)

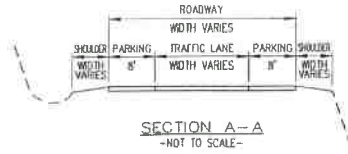
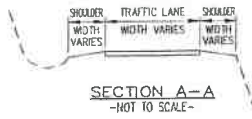

- REFERENCES**
 COUNTY CODE SECTIONS:
 3111-11 DEFINITIONS
 3112-3 ROADWAY WIDTHS
 3112-3 SHOULDER WIDTHS
 3112-4 ROADWAY SURFACE
 3112-5 ROADWAY GRADES
 3112-6 ROADWAY RADIUS
 3112-7 ROADWAY TURNAROUNDS
 3112-11 DEAD-END ROADS
 3112-12 DRIVEWAYS
 3112-13 GATES
 3113-7 SIGNS

NOTES
 NO PARKING IS ALLOWED ON ROADWAY, IN AREAS WHERE PARKING ON THE ROADWAY IS PROBABLE, PAINT CURB RED (WHEN PRESENT) AND/OR INSTALL CA MUTCD R28F(CA) "NO STOPPING - FIRE LANE" SIGNS, AS DIRECTED BY COUNTY. REFERENCE: CA-MUTCD SECTION 2B.46 AND CALIFORNIA VEHICLE CODE SECTION 22500.1

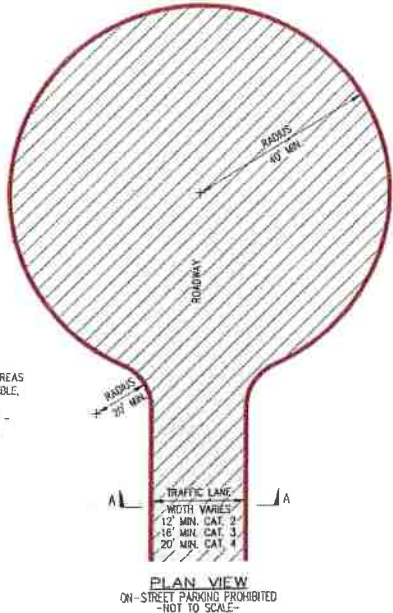

- REFERENCES**
 COUNTY CODE SECTIONS:
 3111-11 DEFINITIONS
 3112-3 ROADWAY WIDTHS
 3112-3 SHOULDER WIDTHS
 3112-4 ROADWAY SURFACE
 3112-5 ROADWAY GRADES
 3112-6 ROADWAY RADIUS
 3112-7 ROADWAY TURNAROUNDS
 3112-11 DEAD-END ROADS
 3112-12 DRIVEWAYS
 3113-7 SIGNS

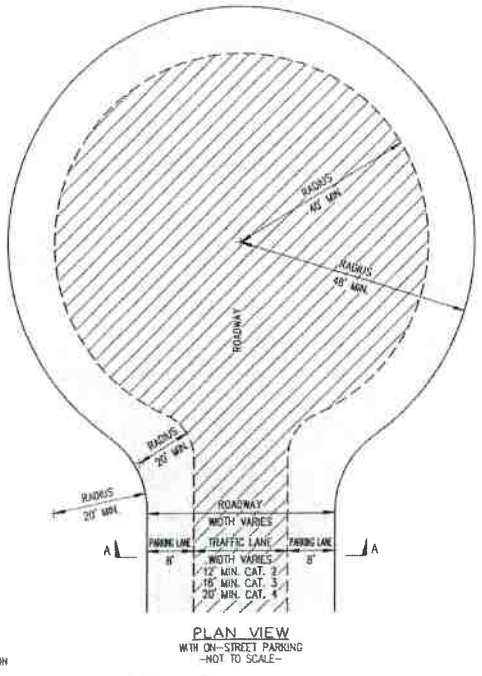
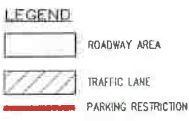

Type 1
 On-Street Parking Prohibited

Type 2
 On-Street Parking Allowed

FIGURE 3112-7A
 Cul-de Sac

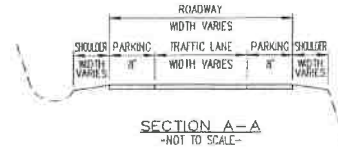
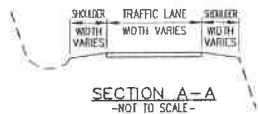

- REFERENCES**
 COUNTY CODE SECTIONS:
 311-11 DEFINITIONS
 312-3 ROADWAY WIDTHS
 312-3 SHOULDER WIDTHS
 312-4 ROADWAY SURFACE
 312-5 ROADWAY GRADES
 312-6 ROADWAY RADII
 312-7 ROADWAY TURNAROUNDS
 312-11 DEAD-END ROADS
 312-12 DRIVEWAYS
 312-13 GATES
 313-7 SIGNS

NOTES
 NO PARKING IS ALLOWED ON ROADWAY. IN AREAS WHERE PARKING ON THE ROADWAY IS PROBABLE, PAINT CURB RED (WHEN PRESENT) AND/OR INSTALL CA-MUTCD R28F(CA) "NO STOPPING - FIRE LANE" SIGNS, AS DIRECTED BY COUNTY. REFERENCE: CA-MUTCD SECTION 2B.46 AND CALIFORNIA VEHICLE CODE SECTION 22500.1

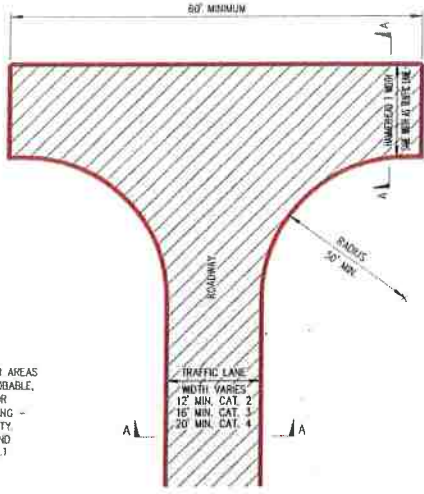

PLAN VIEW
 ON ROADWAY PARKING PROHIBITED
 -NOT TO SCALE-

LEGEND

- ROADWAY AREA
- TRAFFIC LANE
- PARKING RESTRICTION

Type 1
 On-Street Parking Prohibited

- REFERENCES**
 COUNTY CODE SECTIONS:
 311-11 DEFINITIONS
 312-3 ROADWAY WIDTHS
 312-3 SHOULDER WIDTHS
 312-4 ROADWAY SURFACE
 312-5 ROADWAY GRADES
 312-6 ROADWAY RADII
 312-7 ROADWAY TURNAROUNDS
 312-11 DEAD-END ROADS
 312-12 DRIVEWAYS
 312-13 GATES
 313-7 SIGNS

NOTES
 IN AREAS WHERE PARKING AT THE TURN AROUND IS PROBABLE, PAINT CURB RED (WHEN PRESENT) AND/OR INSTALL CA-MUTCD R28F(CA) "NO STOPPING - FIRE LANE" SIGNS, AS DIRECTED BY COUNTY. REFERENCE: CA-MUTCD SECTION 2B.46 AND CALIFORNIA VEHICLE CODE SECTION 22500.1

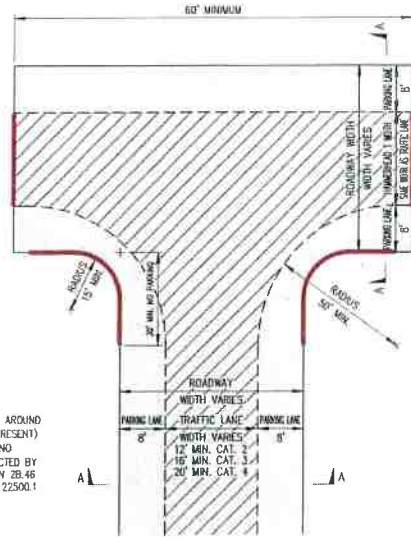

PLAN VIEW
 ON ROADWAY PARKING ALLOWED
 -NOT TO SCALE-

LEGEND

- ROADWAY AREA
- TRAFFIC LANE
- PARKING RESTRICTION

Type 2
 On-Street Parking Allowed

FIGURE 312-7B
 Hammerhead "T"

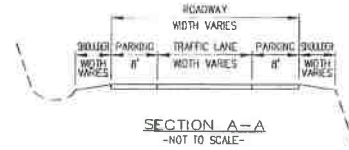
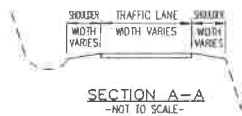

- REFERENCES**
 COUNTY CODE SECTIONS
 3111-11 DEFINITIONS
 3112-3 ROADWAY WIDTHS
 3112-3 SHOULDER WIDTHS
 3112-4 ROADWAY SURFACE
 3112-5 ROADWAY GRADES
 3112-6 ROADWAY RADII
 3112-7 ROADWAY TURNAROUNDS
 3112-11 DEAD-END ROADS
 3112-12 DRIVEWAYS
 3112-13 GATES
 3113-7 SIGNS

NOTES
 NO PARKING IS ALLOWED ON ROADWAY IN AREAS WHERE PARKING ON THE ROADWAY IS PROBABLE. PAINT CURB RED (WHEN PRESENT) AND/OR INSTALL CA-MUTCD R26F(CA) "NO STOPPING - FIRE LANE" SIGNS, AS DIRECTED BY COUNTY. REFERENCE: CA-MUTCD SECTION 2B.46 AND CALIFORNIA VEHICLE CODE SECTION 22500.1



- LEGEND**
- ROADWAY AREA
 - TRAFFIC LANE
 - PARKING RESTRICTION

Type 1
 On-Street Parking Prohibited

- REFERENCES**
 COUNTY CODE SECTIONS
 3111-11 DEFINITIONS
 3112-3 ROADWAY WIDTHS
 3112-3 SHOULDER WIDTHS
 3112-4 ROADWAY SURFACE
 3112-5 ROADWAY GRADES
 3112-6 ROADWAY RADII
 3112-7 ROADWAY TURNAROUNDS
 3112-11 DEAD-END ROADS
 3112-12 DRIVEWAYS
 3112-13 GATES
 3113-7 SIGNS

NOTES
 IN AREAS WHERE PARKING AT THE TURN AROUND IS PROBABLE, PAINT CURB RED (WHEN PRESENT) AND/OR INSTALL CA-MUTCD R26F(CA) "NO STOPPING - FIRE LANE" SIGNS, AS DIRECTED BY COUNTY. REFERENCE: CA-MUTCD SECTION 2B.46 AND CALIFORNIA VEHICLE CODE SECTION 22500.1

- LEGEND**
- ROADWAY AREA
 - TRAFFIC LANE
 - PARKING RESTRICTION

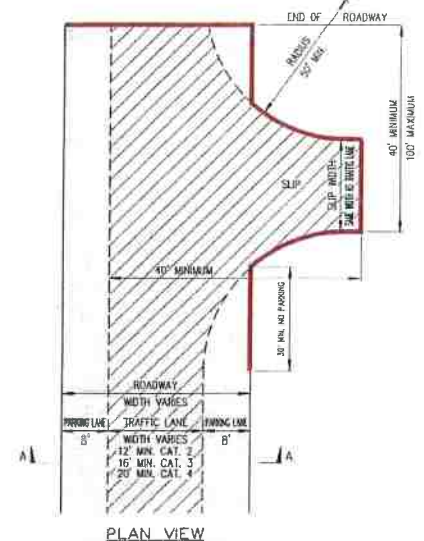

Type 2
 On-Street Parking Allowed

FIGURE 3112-7C
 Slip "T"

3112-8. ROADWAY TURNOUTS.

Turnouts shall be designed in conformance with the County Roadway Design Manual. Turnouts shall be required on roadways constructed to the standard of Road Category 2 and at locations as specified in these regulations. Turnouts shall be a minimum of twenty (20) feet wide, to include width of adjacent traffic lane, and thirty (30) feet long with a minimum of 25 foot taper on each end (eighty (80) feet total length). Turnout designs shall conform to the diagram below. (Ord. 1952, § 1, 12/17/1991; amended by Ord. 2540, Section 1, 11/17/2015)

FIGURE 3112-8
Roadway Turnout

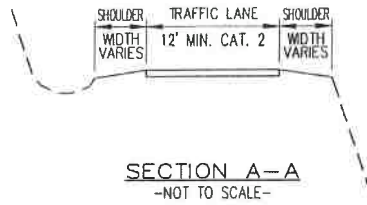

REFERENCES

- COUNTY CODE SECTIONS:
 3111-11 DEFINITIONS
 3112-3 ROADWAY WIDTHS
 3112-3 SHOULDER WIDTHS
 3112-4 ROADWAY SURFACE
 3112-5 ROADWAY GRADES
 3112-6 ROADWAY RADIUS
 3112-8 TURNOUTS
 3112-12 DRIVEWAYS
 3113-7 SIGNS

NOTES

NO PARKING IS ALLOWED ON ROADWAY. IN AREAS WHERE PARKING ON THE ROADWAY IS PROBABLE, PAINT CURB RED (WHEN PRESENT) AND/OR INSTALL CA-MUTCD R26F(CA) "NO STOPPING - FIRE LANE" SIGNS, AS DIRECTED BY COUNTY. REFERENCE CA-MUTCD SECTION 2B.46 AND CALIFORNIA VEHICLE CODE SECTION 22500.1



LEGEND

-  ROADWAY AREA
-  TRAFFIC LANE
-  PARKING RESTRICTION

3112-9. ROADWAY STRUCTURES.

- (a) All driveway, road, street, and private lane roadway structures shall be constructed to carry at least the maximum load and provide the minimum vertical clearance as required in California Vehicle Code Sections 35250, 35550, and 35750. Where a bridge, culvert or an elevated surface is part of a fire apparatus access road, the roadway structure shall be constructed and maintained in accordance with the American Association of State and Highway Transportation Officials Standard Specifications for Highway Bridges, 17th Edition, published 202 (known as AASHTO HB-17), hereby incorporated by reference, or an equivalent or greater AASHTO standard as may be from time to time adopted. Roadway structures shall be designed for a live load sufficient to carry the imposed loads of fire apparatus. The minimum vertical clearance shall be 15 feet at all points on the surface of the roadway. (Ord. 1952, § 1, 12/17/1991; amended by Ord. 2540, Section 1, 11/17/2015)

- (b) Appropriate signing, including but not limited to vehicle load, vertical clearance, one-way road, or single lane conditions, shall be posted at both entrances to bridges. This requirement may be omitted for bridges on private roads and driveways where compliance with paragraph (a) of this section has been demonstrated to the satisfaction of the Director of Public Works. Where elevated surfaces designed for emergency vehicle use are adjacent to surfaces which are not designed for such use, barriers or signs, or both, as approved by the Department of Public Works, shall be installed and maintained. (Ord. 1952, § 1, 12/17/1991; amended by Ord. 2540, Section 1, 11/17/2015)
- (c) A bridge with only one traffic lane may be authorized by the County; however, the bridge shall provide for unobstructed visibility from one end to the other and shall have intervisible turnouts at both ends. (Ord. 1952, § 1, 12/17/1991)
- (d) The County may allow a flatcar bridge having a width of not less than nine (9) feet to be used as a roadway structure on a private lane or driveway provided the requirements of Section 3112-9(c) are satisfied. No exception request shall be required for the reduced roadway width. (Ord. 1952, § 1, 12/17/1991)

3112-10. ONE-WAY ROADS.

All one-way roads shall be constructed to provide a minimum, not including shoulders, of one ~~to~~ twelve (12) foot traffic lane. The County may approve one-way roads. All one-way roads shall connect to a two-lane roadway at both ends, and shall provide access to an area currently zoned for no more than ten (10) dwelling units. In no case shall it exceed 2,640 feet in length. A turnout shall be placed approximately at the midpoint of each one-way road. (Ord. 1952, § 1, 12/17/1991; amended by Ord. 2540, Section 1, 11/17/2015)

3112-11. DEAD-END ROADS.

- (a) The maximum length of a dead-end road, including all dead-end roads accessed from that dead-end road, shall not exceed the following cumulative lengths, regardless of the number of parcels served: (Ord. 1952, § 1, 12/17/1991)

| | |
|--|-----------|
| parcels zoned for less than one acre | 800 feet |
| parcels zoned for 1 acre to 4.99 acres | 1350 feet |
| parcels zoned for 5 acres to 19.99 acres | 2640 feet |
| parcels zoned for 20 acres to 39.99 acres | 5280 feet |
| parcels zoned for 40 acres to 159.99 acres | 7500 feet |
| parcels zoned for 160 acres or larger | Unlimited |

All lengths shall be measured from the edge of the roadway surface at the intersection that begins the road to the end of the road surface at its farthest point. Where a dead-end road crosses areas of differing zoned parcel sizes, requiring different length limits, the shortest allowable length shall apply. (Ord. 1952, § 1, 12/17/1991)

- (b) Where parcels are zoned 5 acres or larger, turnarounds shall be provided at a maximum of 1320 foot intervals. (Ord. 1952, § 1, 12/17/1991)
- (c) Each dead-end road shall have a turnaround constructed at its terminus. (Ord. 1952, § 1, 12/17/1991)

3112-12. DRIVEWAYS.

- (a) All driveways shall be constructed to provide a minimum Road Category 1 standard of one ten (10) foot traffic lane and fourteen (14) feet of unobstructed horizontal clearance (two (2) feet on each side of the traffic lane). The minimum vertical clearance shall be 15 feet along its entire length. Driveways in excess of 1320 feet in length shall be constructed to the standard for Road Category 2 of one twelve (12) foot traffic lane. (Ord. 1952, § 1, 12/17/1991; amended by Ord. 2540, Section 1, 11/17/2015)

- (b) Driveways exceeding 150 feet in length, but less than 800 feet in length, shall provide a turnout near the midpoint of the driveway. Where a driveway exceeds 800 feet, turnouts shall be spaced at intervals at approximately 400 foot intervals. The location and spacing of turnouts shall be in conformance with the County Roadway Design Manual. (Ord. 1952, § 1, 12/17/1991; amended by Ord. 2540, Section 1, 11/17/2015)
- (c) A turnaround shall be provided at all building sites on driveways over 300 feet in length, or 200 feet if required by the local fire agency, and shall be within fifty (50) feet of the building. (Ord. 1952, § 1, 12/17/1991; amended by Ord. 2540, Section 1, 11/17/2015)

3112-13. GATE ENTRANCES.

- (a) Gate entrances shall be at least two (2) feet wider than the width of the traffic lane(s) serving the gate, and a minimum width of fourteen (14) feet of unobstructed horizontal clearance and unobstructed vertical clearance of fifteen (15) feet. (Ord. 1952, § 1, 12/17/1991; amended by Ord. 2540, Section 1, 11/17/2015)
- (b) All gates providing access from a road to a driveway shall either: (Ord. 1952, § 1, 12/17/1991)
 - (1) be located a minimum of thirty (30) feet from the roadway, or (Ord. 1952, § 1, 12/17/1991)
 - (2) if located closer than thirty (30) feet from the roadway, turnout(s) shall be constructed near the gate entrance to allow parking next to the traffic lane(s) for use from each direction of travel. The location of the turnouts shall permit safe turning movements and maintain adequate sight visibility. (Ord. 1952, § 1, 12/17/1991)
- (c) All gates providing access from a road to a driveway shall open to allow a vehicle to stop without obstructing traffic on that road. (Ord. 1952, § 1, 12/17/1991)
- (d) Where a one-way road with a single traffic lane provides access to a gated entrance, a forty (40) foot turning radius shall be used. (Ord. 1952, § 1, 12/17/1991 ; amended by Ord. 2540, Section 1, 11/17/2015)
- (e) Security gates shall not be installed without approval and where security gates are installed, they shall have an approved means of emergency operation acceptable to CAL FIRE and the local fire agency. The security gates and the emergency operation shall be maintained operational at all times. (Added by Ord. 2540, Section 1, 11/17/2015)

CHAPTER 3

SIGNING AND BUILDING NUMBERING

3113-1. SIGNING AND BUILDING NUMBERING - INTENT.

To facilitate locating a fire and to avoid delays in response, all newly constructed or approved roads, streets, and building shall be designated by names or numbers, posted on signs clearly visible and legible from the roadway. This section shall not restrict the size of letters or numbers appearing on street signs for other purposes. (Ord. 1952, § 1, 12/17/1991)

3113-2. SIZE OF LETTERS, NUMBERS AND SYMBOLS FOR STREET AND ROAD SIGNS.

Notwithstanding any other provisions of the Code, the size of letter, numbers, and symbols for street and road signs shall be a minimum 4 inch letter height, 1/2 inch stroke, reflectorized, and contrasting with the background color of the sign. Wooden street and road signs meeting the standards for letter height, stroke, and contrast shall be permitted in all locations with an exception issued pursuant to Sections 3111-7 through 3111-10 of this ordinance. (Ord. 1952, § 1, 12/17/1991; amended by Ord. 2540, Section 1, 11/17/2015)

3113-3. VISIBILITY AND LEGIBILITY OF STREET AND ROAD SIGNS.

Street and road signs shall be visible from both directions of vehicle travel for a distance of at least 100 feet. (Ord. 1952, § 1, 12/17/1991)

3113-4. HEIGHT OF STREET AND ROAD SIGNS.

Height of street and road signs shall be uniform county wide, and meet the visibility and legibility standards of these regulations. (Ord. 1952, § 1, 12/17/1991)

3113-5. NAMES AND NUMBERS ON STREET AND ROAD SIGNS.

Newly constructed or approved public and private roads and streets must be identified by a name or number consistent with the Uniform Numbering System as set forth in Humboldt County Code Sections 442-1 through 441-11. All signs shall be mounted and oriented in a uniform manner. (Ord. 1952, § 1, 12/17/1991)

3113-6. INTERSECTING ROADS, STREETS AND PRIVATE LANES.

Signs required by these regulations identifying intersecting roads, streets and private lanes shall be placed at the intersection of those roads, streets, and/or private lanes. (Ord. 1952, § 1, 12/17/1991)

3113-7. SIGNS IDENTIFYING TRAFFIC ACCESS LIMITATIONS.

A sign identifying access flow limitation, including but not limited to weight or vertical clearance limitations, dead-end road, one way road or single lane conditions, shall be placed: (Ord. 1952, § 1, 12/17/1991)

- (a) at the intersection preceding the traffic access limitation, and (Ord. 1952, § 1, 12/17/1991)
- (b) no more than 100 feet before such traffic access limitation. (Ord. 1952, § 1, 12/17/1991)

3113-8. INSTALLATION OF ROAD, STREET AND PRIVATE LANE SIGNS.

Road, street and private lanes signs required by these regulations shall be installed prior to final acceptance by the County of road improvements. (Ord. 1952, § 1, 12/17/1991)

3113-9. ADDRESSES FOR BUILDINGS.

All buildings shall be issued an address in accordance with the County Uniform Numbering System, Humboldt County Code Section 442 et seq. Accessory buildings will not be required to have a separate address; however, each dwelling unit within a building shall be separately identified. (Ord. 1952, § 1, 12/17/1991)

3113-10. SIZE OF LETTERS, NUMBERS AND SYMBOLS.

Notwithstanding Humboldt County Code Section 442-1, the size of letters numbers and symbols for addresses shall be a minimum 4 inch letter height, 1/2 inch stroke, reflectorized, and contrasting with the background color of the sign. Addresses shall use Arabic numbers and alphabetical letters. Wooden address signs meeting the standards for letter height, stroke, and contrast shall be permitted in all locations with an exception issued pursuant to Sections 3111-7 through 3111-10 of this ordinance. (Ord. 1952, § 1, 12/17/1991; amended by Ord. 2540, Section 1, 11/17/2015)

3113-11. INSTALLATION, LOCATION AND VISIBILITY OF ADDRESSES.

- (a) All buildings shall have a permanently posted address, which shall be placed at each driveway entrance and visible from both directions of travel along the road fronting the property. In all cases, the address shall be posted at the beginning of construction and shall be maintained thereafter, and the address shall be visible and legible from the road on which the address is located. (Ord. 1952, § 1, 12/17/1991; amended by Ord. 2540, Section 1, 11/17/2015)
- (b) Address signs along one-way roads shall be visible from both the intended direction of travel and the opposite direction. (Ord. 1952, § 1, 12/17/1991)
- (c) Where multiple addresses are required at a single driveway, they shall be mounted on a single post. (Ord. 1952, § 1, 12/17/1991)
- (d) Where a roadway provides access and to a single commercial or industrial business, the address sign shall be placed at the nearest road intersection providing access to that site. (Ord. 1952, § 1, 12/17/1991)

CHAPTER 4

EMERGENCY WATER STANDARDS

3114-1. WATER STANDARDS - INTENT.

Emergency water for wildfire protection shall be available, accessible, and maintained in quantities and locations specified in statute and these regulations, in order to attack a wildfire and defend property from a wildfire. (Ord. 1952, § 1, 12/17/1991; amended by Ord. 2540, Section 1, 11/17/2015)

3114-2. APPLICATION.

The provisions of this chapter shall apply in the tentative and parcel map process when new parcels are approved by the County. When a water supply for structure defense is required to be installed, such protection shall be installed and made serviceable before and during the time of construction except when alternative methods of protection are provided and approved by the local authority having jurisdiction. A water source on an adjacent parcel for which the subject property has access by means of a recorded easement shall be accepted as meeting the intent of this section. (Ord. 1952, § 1, 12/17/1991; amended by Ord. 2540, Section 1, 11/17/2015)

3114-3. GENERAL STANDARDS.

- (a) Water systems that comply with the below standard or standards meet or exceed intent of these regulations:

Water systems equaling or exceeding the National Fire Protection Association (NFPA) Standard 1142, "Standard on Water Supplies for Suburban and Rural Fire Fighting," 2012 Edition, hereby incorporated by reference, or California Fire Code, California Code of Regulations, title 24, part 9, shall be accepted as meeting the requirements of this section. (Ord. 1952, § 1, 12/17/1991; amended by Ord. 2540, Section 1, 11/17/2015)

- (b) Notwithstanding the above water system standards, a water system serving an individual residential dwelling which meets the 2,500 gallon emergency water supply requirements of the County's Alternative Owner Builder Ordinance, Humboldt County Code Section 331.5-13(h), and which conforms to the minimum pipe size and valving requirements set forth in these regulations, shall be accepted as meeting the requirements of this section. (Ord. 1952, § 1, 12/17/1991)
- (c) Such emergency water may be provided in a fire agency mobile water tender, or naturally occurring or manmade containment structure, as long as the specified quantity is immediately available. (Ord. 1952, § 1, 12/17/1991; amended by Ord. 2540, Section 1, 11/17/2015)
- (d) Nothing in these regulations prohibits the combined storage of emergency wildfire and structural firefighting water supplies unless so prohibited by local ordinance or specified by the local fire agency. (Ord. 1952, § 1, 12/17/1991; amended by Ord. 2540, Section 1, 11/17/2015)
- (e) Where freeze protection is required by the County or local fire agency, such measures shall be provided. (Ord. 1952, § 1, 12/17/1991; amended by Ord. 2540, Section 1, 11/17/2015)

3114-4. HYDRANT/FIRE VALVE.

- (a) The hydrant or fire valve shall be eighteen (18) inches above grade, eight (8) feet from flammable vegetation, no closer than four (4) feet nor farther than twelve (12) feet from a roadway, and in a location where fire apparatus using it will not block the roadway. (Ord. 1952, § 1, 12/17/1991; amended by Ord. 2540, Section 1, 11/17/2015)

The hydrant serving any building shall: (Ord. 1952, § 1, 12/17/1991)

- (1) be not less than fifty (50) feet nor more than 1/2 mile from the building it is to serve, except that a hydrant serving any building on a lot less than ten (10) acres in acre shall be located within 500 feet of the building; provided that the local fire agency may allow a hydrant to be located up to 1000 feet from the building when site conditions warrant. (Ord. 1952, § 1, 12/17/1991; amended by Ord. 2540, Section 1, 11/17/2015)
 - (2) be located at a turnout or turnaround, along the driveway to that building or along the road that intersects with that driveway. (Ord. 1952, § 1, 12/17/1991)
- (b) The hydrant head shall be brass or other corrosion resistant material with 2-1/2 inch National Hose male thread with a cap for pressure and gravity flow systems, and 4-1/2 inch National Hose male thread for draft systems. Such hydrants shall be wet or dry barrel as required by the delivery system. Crash protection meeting the requirements of the Uniform Mechanical Code shall be installed as required by the County. (Ord. 1952, § 1, 12/17/1991; amended by Ord. 2540, Section 1, 11/17/2015)
- (c) All pipes supplying water to hydrants must be at least 3 inches in diameter; however, a pipe having a diameter of less than 3 inches may be used provided it can demonstrate the capability of supplying a minimum 200 gallon per minute (gpm) flow from the hydrant connection. (Ord. 1952, § 1, 12/17/1991)

3114-5. SIGNING OF WATER SOURCES.

Each hydrant/fire valve or access to water shall be identified as follows:

- (a) if located along a driveway, except where the residence is served with an individual water supply, a reflectorized blue marker with a minimum dimension of three (3) inches shall be located on the driveway address sign and mounted on a fire retardant post; or
- (b) if located along a driveway where a residence is served with an individual water supply, a wooden sign with a minimum three (3) inch letter height, 3/8 inch stroke, contrasting with the background color of the sign, with the wording "FIRE WATER" mounted on a wooden post or compliance with section (a) above shall be acceptable with an exception issued pursuant to Sections 3111-7 through 3111-10 of this ordinance, or (Ord. 1952, § 1, 12/17/1991; amended by Ord. 2540, Section 1, 11/17/2015)
- (c) if located along a street or road, (Ord. 1952, § 1, 12/17/1991)
 - (1) a reflectorized blue marker, with a minimum dimension of three (3) inches, shall be mounted on a fire retardant post. The sign post shall be within three (3) feet of said hydrant/fire valve, with the sign no less than three (3) feet nor greater than five (5) feet above the ground, in a horizontal position and visible from the roadway, or (Ord. 1952, § 1, 12/17/1991)
 - (2) as specified in the State Fire Marshal's Guidelines for Hydrant Markings Along State Highways and Freeways, May 1988. (Ord. 1952, § 1, 12/17/1991); amended by Ord. 2540, Section 1, 11/17/2015)

CHAPTER 5

FUEL MODIFICATION STANDARDS

3115-1. FUEL MODIFICATION - INTENT.

To reduce the intensity of wildfire by reducing the volume and density of flammable vegetation, the strategic siting of fuel modification and greenbelts shall provide (1) increased safety for emergency fire equipment and evacuating civilians by its utilization around structures and roads, including driveways; and (2) a point of attack or defense from a wildfire. (Ord. 1952, § 1, 12/17/1991; amended by Ord. 2540, Section 1, 11/17/2015)

3115-2. SETBACK FOR STRUCTURE DEFENSIBLE SPACE.

- (a) Notwithstanding other provisions of this Code, all parcels one (1) acre and larger shall provide a minimum 30 foot setback for buildings and accessory buildings from all property lines and/or the center of a road, except as provided herein: (Ord. 1952, § 1, 12/17/1991)
- (1) a building or accessory building may be located closer than 30 foot to a property line where a maintenance and open space easement for the benefit of the subject parcel has been recorded over the adjoining lot. The extent of the adjustment shall be no greater than the width of the easement, and no exception from minimum setbacks as specified in other provisions of this Code are granted pursuant to this section. (Ord. 1952, § 1, 12/17/1991)
 - (2) a detached accessory building may be located within the 30 foot setback when it is constructed using non-combustible or fire resistive materials, and is located not closer than 20 feet to another building. (Ord. 1952, § 1, 12/17/1991)

The required specific distance between buildings or structures and property lines or the centerline of the road shall be measured perpendicularly in a horizontal plane extending across the complete length of said property line or lines and/or roadway. (Ord. 1952, § 1, 12/17/1991)

- (b) For parcels less than one (1) acre, the County shall provide for the same practical effect (Ord. 1952, § 1, 12/17/1991)

Methods of achieving the "same practical effect" include but are not limited to: (Ord. 1952, § 1, 12/17/1991)

- (1) development of a community water system meeting the specifications as set forth in Section 3114-3 (a-c); (Ord. 1952, § 1, 12/17/1991)
- (2) establishment of a County Service Area or other acceptable form of district or association to provide maintenance of defensible space measures, including vegetation modification; (Ord. 1952, § 1, 12/17/1991)
- (3) use of non-combustible or fire-resistive materials in construction of buildings or installation of sprinklers within buildings; (Ord. 1952, § 1, 12/17/1991)
- (4) development of greenbelts in strategic locations around the subdivision or parcels; or (Ord. 1952, § 1, 12/17/1991)
- (5) road development which provides for travel lanes and parking lanes that exceed the minimum requirements of these regulations. (Ord. 1952, § 1, 12/17/1991)

3115-3. DISPOSAL OF FLAMMABLE VEGETATION AND FUELS.

Disposal, including chipping, burying, burning or removal to a landfill site approved by the County, of flammable vegetation and fuels caused by site development and construction, road and driveway construction, and fuel modification shall be completed prior to completion of road construction or final inspection of a building permit or initiation of a use under a use permit. (Ord. 1952, § 1, 12/17/1991)

3115-4. GREENBELTS.

Subdivisions and other developments, which propose greenbelts as a part of the development plan, shall locate said greenbelts strategically, as a separation between wildland fuels and structures. The locations shall be approved by the inspection authority and should be consistent with the CAL FIRE Unit Fire Management Plan, where in effect. (Ord. 1952, § 1, 12/17/1991; amended by Ord. 2540, Section 1, 11/17/2015)

CHAPTER 6

ENFORCEMENT

3116-1. VIOLATION.

The following provisions shall apply to violations of the regulations as contained in this ordinance. All of the remedies provided for in this section shall be cumulative and no inclusive. (Ord. 1952, § 1, 12/17/1991)

- (a) Penalty. Any person, whether principal, agent, employee or otherwise, violating or causing or permitting the violation of any of the provisions of this Code shall be guilty of a misdemeanor and shall be subject to the penalties provided for in Section 112-5 of the Humboldt County Code. (Ord. 1952, § 1, 12/17/1991)
- (b) Public Nuisance. Any new development operated or maintained contrary to the provisions of this Code shall be the same hereby is declared to be a public nuisance and shall be subject to injunction and abatement as such. (Ord. 1952, § 1, 12/17/1991)

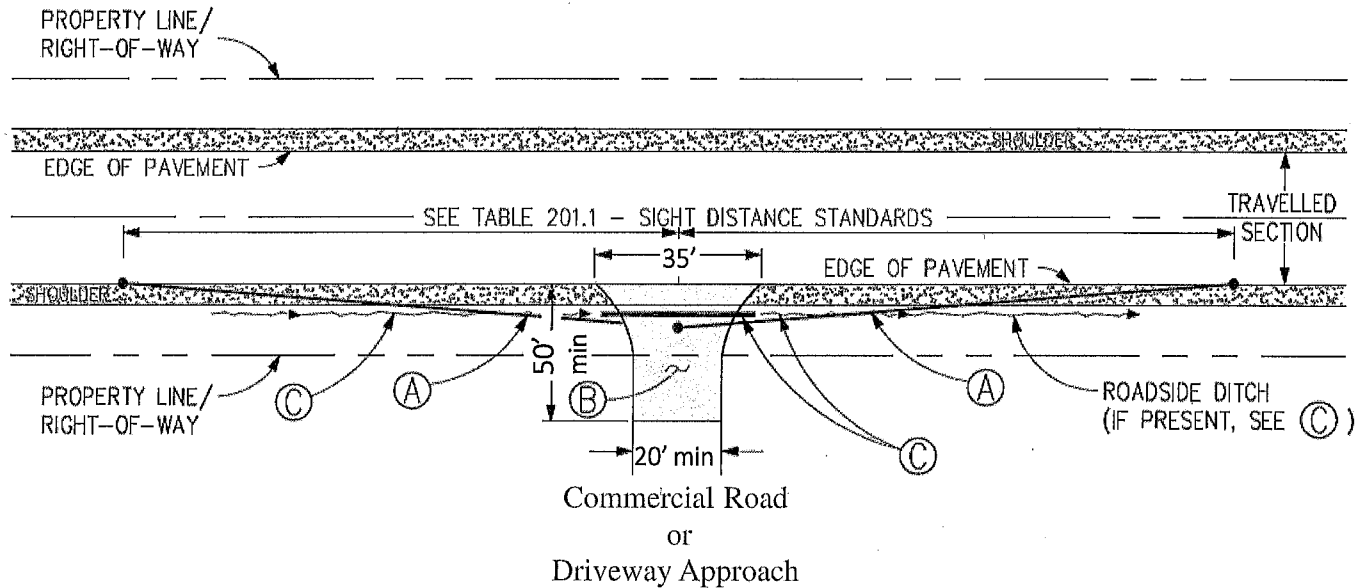

NOTE

All proposed driveway or road encroachments onto any County maintained road of within County right-of-way will be reviewed by the Department of Public Works on a case-by-case basis. This policy may result in modification to the standards or requirements set forth on this sheet.

(C) ROADSIDE DRAINAGE

The construction of any driveway approach shall not adversely impact or alter existing roadside drainage. The installation of a culvert pipe under the driveway approach in the existing ditch may be required if flow levels warrant it. Pipe size, length and location shall be determined by the Department of Public Works.

(A) SIGHT VISIBILITY LINE (TRIANGLE)

An area of unobstructed sight visibility shall be established and maintained beginning at a point 8 feet back from the edge of the existing pavement and extending each direction from the centerline of the new driveway approach.

(B) DRIVEWAY APPROACH SURFACING

If the existing County road surface is paved, the new driveway approach shall be paved with 2 inches of Type B asphalt concrete (or sufficient seal coat) on top of a minimum of 4 inches of aggregate base. The paved area shall extend a minimum of 50' feet back from the edge of the existing pavement and be flared approximately 35' feet at the intersection with the County road. The driveway shall intersect the County road at a 90° angle. The driveway grade shall not exceed 2% in the first 25 feet.

SIGHT DISTANCE STANDARDS

| Design Speed ⁽¹⁾ (mph) | Stopping ⁽²⁾ (mph) | Passing ⁽³⁾ (mph) |
|--------------------------------------|----------------------------------|---------------------------------|
| 20 | 125 | 800 |
| 25 | 150 | 950 |
| 30 | 200 | 1100 |
| 35 | 250 | 1300 |
| 40 | 300 | 1500 |
| 45 | 360 | 1650 |
| 50 | 430 | 1800 |
| 55 | 500 | 1950 |
| 60 | 580 | 2100 |
| 65 | 660 | 2300 |
| 70 | 750 | 2500 |
| 75 | 840 | 2600 |
| 80 | 930 | 2700 |

(1) See Topic 101 for selection of design speed.
 (2) Increase by 20% on sustained downgrades >3%



COUNTY OF HUMBOLDT
 DEPARTMENT OF PUBLIC WORKS
 1106 SECOND STREET * EUREKA * CA * 95501
 TEL (707) 445-7377 * FAX (707) 445-7409

**Commercial Rural
 Driveway No. 1**

STD DWG
 SHT 1 OF 1



UNIVERSITY OF CALIFORNIA
Division of Agriculture
and Natural Resources
<http://anrcatalog.ucdavis.edu>

PUBLICATION 8262

Rural Roads: A Construction and Maintenance Guide for California Landowners

SUSAN D. KOCHER, UC Cooperative Extension Natural Resources Advisor, El Dorado County; **JARED M. GERSTEIN**, Staff Research Associate, Center for Forestry, University of California, Berkeley; and **RICHARD R. HARRIS**, UC Cooperative Extension Specialist, University of California, Berkeley

Many thousands of miles of privately maintained rural roads extend throughout California, and they are used for resource management as well as residential and recreational access by over 500,000 landowners (fig. 1). The California Department of Forestry and Fire Protection (CAL FIRE) estimates that another 2.7 million acres of forest and rangeland will be developed over the next 40 years, requiring the construction of thousands of miles of new roads (CAL FIRE 2003). Poorly located, designed, or maintained roads are the primary cause of water quality degradation in rural watersheds.

This publication is designed to help rural landowners understand how to improve and maintain existing roads. It also provides guidance on planning new roads. It is written for people who have little to no previous experience in managing a road. If you have recently purchased a rural parcel or have become responsible for road maintenance on an existing parcel—or otherwise feel unprepared for maintaining roads—this publication should help you. It mainly addresses single-lane dirt or rock-surfaced rural roads, also known as “low-volume” roads because they are not expected to carry high traffic levels.

This publication should enable you to

- understand the basic principles of good road design and maintenance
- recognize current and potential road erosion and drainage problems
- consider remedial treatments that may be needed
- develop rough estimates for the costs of road improvements and maintenance
- communicate clearly with contractors who may perform work on your roads



Figure 1. Low-volume road that has been newly graded and out-sloped, San Bernardino County. *Photo:* Richard Harris.

UC PEER REVIEWED



Figure 2. This cross drain delivers sediment from the roadside ditch under the road surface to a nearby stream. The road fill is also eroding. *Photo: Jared Gerstein.*

WHY WORRY ABOUT ROAD DESIGN AND MAINTENANCE?

Road maintenance should be considered an unavoidable necessity of living in a rural area. Landowners should take the time to learn about roads because when they are well designed and maintained they have fewer impacts on the environment, are more reliable, and cost less to maintain than problem roads.

Environmental impacts

Rural roads are a major source of sediment that ends up in stream channels (fig. 2). This is especially true for unpaved roads located near streams that are used year-round. Sediment delivered to streams from roads causes streams to run muddy and take a long time to clear after storms. Sediment can end up depositing in pools and adversely affect habitat for fish and other aquatic organisms.

Reliability

Poorly designed, located, or maintained roads have a higher risk of failing during storms than roads that are well constructed and maintained. Adequately sized culverts, free-flowing ditches, and properly drained road surfaces are essential elements of a reliable road network. Without these elements in place, even a moderate winter storm can render a road impassable.

Cost of repetitive maintenance

The bottom line is that it can be extremely expensive to maintain roads that are designed, located, or constructed poorly.

It is usually more cost effective to identify and remedy chronic road problems than to treat only the symptoms of the problem year after year. For example, it will cost less in the long run to install proper drainage structures and rock surfacing on a road that gets muddy and rutted every winter than to regrade the road surface every spring.

UNDERSTANDING ROAD COMPONENTS

Although roads vary in their configuration and design, they have common elements that affect their functionality and durability. Roads must create a flat surface for vehicle travel on sloped land. To do this, part of the hillslope is cut away (the *cut slope*) and the removed soils are placed below (the *fill slope*) and compacted to create a flat bench or *traveled way*. This is called *cut-and-fill* construction (fig. 3). A *balanced cut-and-fill* project uses all the cut material to generate the fill. In *full-bench* construction, the cut is made wide enough to accommodate the entire traveled way (fig. 4). The cut mate-

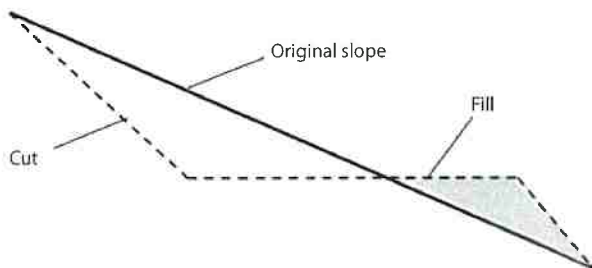

Figure 3. Cut-and-fill road construction design. *Source: Kramer 2001.*

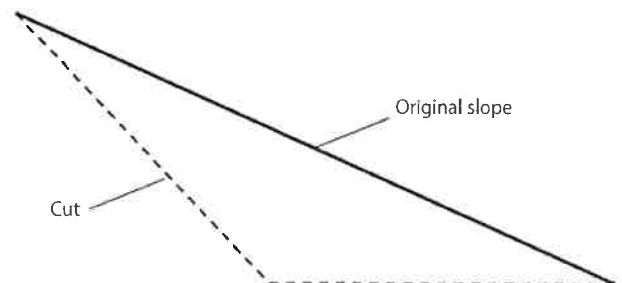

Figure 4. Full-bench road construction design. *Source: Redrawn from Kramer 2001.*

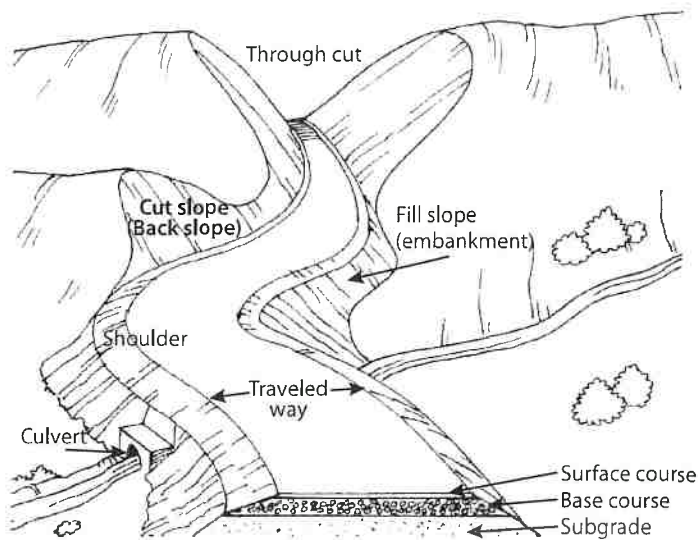

Figure 5. Components of a road. Source: Keller and Sherar 2003.

material is not used in the road construction and must be hauled (*end-hauled*) to an off-site disposal area. Full-bench construction reduces the risk of fill slope failure but is usually more expensive due to hauling costs.

Ideally, a road should consist of three layers (fig. 5). The *subgrade* is the bottommost layer at the level of the in-place material. The *base course* is the main load-spreading layer and typically consists of gravels or gravelly soils, with sand and/or clay intermixed. The *surface course* or *surfacing* may consist of native materials, imported rock, or asphalt. It is placed on top of the base course to improve rider comfort, provide structural support, and weatherproof the road for wet season use. As a practical matter, many rural roads are not constructed in this way but consist entirely of native materials encountered during grading. This can be a factor contributing to poor performance.

All roads must incorporate features to drain water off the road surface and allow it to cross from one side to the other. Road drainage is the key to a road's integrity. *Culverts* are metal, concrete, or plastic pipes set beneath the road surface to drain ditches, springs, or streams crossed by the road. Culverts move water from the inside of the road (next to the cut slope) through a pipe to the outside of the road (to the fill slope or edge of bench). *Ditches* are used to collect water that accumulates from the road surface or hillslope on the inside or cut-slope side of an in-sloped road. *Ditch relief culverts* drain the accumulated water from the inside ditch to the outside of the road.

Besides culverts, common stream-crossing structures include bridges and low-water crossings or fords. *Bridges* usually cause fewer environmental impacts than culverts because they may not alter the natural channel form or require placement of fill in the channel. However, they are often more expensive to install than culverts. *Low-water fords* involve modifying and sometimes hardening a swale or stream channel to allow vehicles to drive through during low-flow periods (figs. 6 and 7). Less fill is introduced to the stream channel; however, vehicles driving through may input sediment to the stream continuously. Fords are typically impassable during high flows and so are rarely suitable for permanent roads.



Figure 6. Low-water crossing on a perennial stream, San Bernardino County. Photo: Richard Harris.



Figure 7. Concreted low-water crossing placed on bedrock outcrop in intermittent stream. Photo: Angela Wilson, Central Valley Regional Water Quality Control Board.



Figure 8. Rolling dips installed to drain an out-sloped road. *Source:* Bill Weaver, Pacific Watershed Associates.



Figure 9. Water bars installed on a road after timber harvesting. *Source:* Angela Wilson, Central Valley Regional Water Quality Control Board.

Rolling dips are constructed breaks in the road grade designed to drain water directly from the road surface to the outside of a road without using an inside ditch or ditch relief culvert (fig. 8). They require vehicles to slow their speed of travel.

A *water bar* is a mound of soil and an accompanying ditch on the road surface that interrupts water flow and diverts it off the road surface (fig. 9). It is typically not passable by vehicles and so is not used on permanent roads. A *berm* is a ridge of rock, soil, or asphalt usually found on the outside of a road shoulder to control surface water. It directs runoff to specific locations where water can be discharged without causing erosion. *Armoring* is the placement of a layer of rock on cut or fill slopes or ditches to prevent water from eroding the soil.

UNDERSTANDING ROAD DESIGN AND DRAINAGE

Draining water from the road surface quickly, without letting it concentrate, is key to preventing erosion and thus to maintaining a stable driving surface. Two characteristics influence how well water drains from the road surface: the steepness of the road (i.e. its *grade* or *gradient*), and the shape and cross slope of the traveled way. The gradient of the road is determined by its location and routing; thus, it cannot be changed without moving the road. The cross-sectional shape and slope of a road are the primary design features that may be manipulated to improve drainage.



Figure 10. These ruts were created by wet-weather use of an unsurfaced, poorly drained road. *Photo:* Angela Wilson, Central Valley Regional Water Quality Control Board.

Gradient

Roads with a gentle gradient are easiest to maintain as long as the slope is adequate to drain the water off the road surface. In general, road grades need to be a minimum of two percent to facilitate drainage, so that water will not accumulate on the surface and saturate the subgrade. Saturated subgrades in combination with repetitive splash erosion due to vehicle traffic are responsible for pot-holes and ruts (fig. 10). Steeper roads drain water more quickly, but this allows the water to develop more erosive power, necessitating measures to prevent erosion and destabilization.

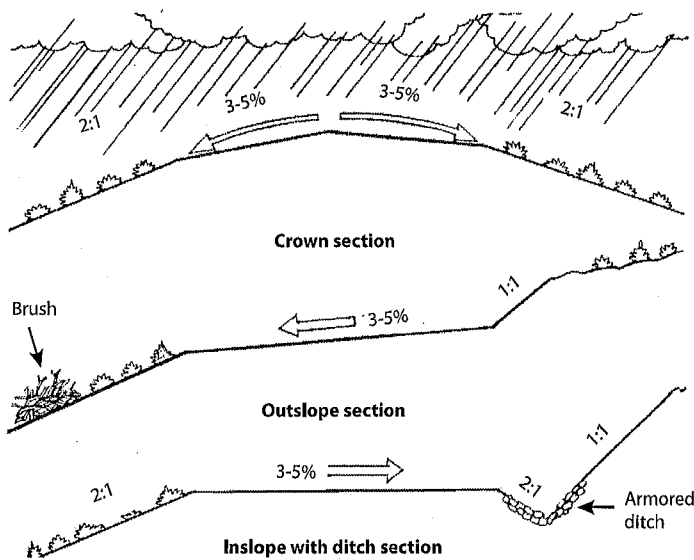

Figure 11. Typical road drainage options. Source: Keller and Sherar 2003.

Shape and slope of the surface

The shape and slope of the road surface determines how water will drain from it (fig. 11). In-sloped, out-sloped, and crowned roads drain water differently. The surface of an *in-sloped* road has a gentle tilt towards the cut slope of the hillside. Water collecting on the surface is drained into a ditch constructed between the road surface and the cut slope. Until recently, most roads in California were designed and constructed as in-sloped roads. When constructed in native materials, in-sloped roads are prone to erosion. Erosion can occur in the ditch, due to concentrated flow; on the road surface when ditch capacity is exceeded; or at the outfalls of culverts and cross drains receiving ditch flow. Ditch relief culverts must be installed frequently to accept ditch flow and dispose of it in a nonerosive manner.

Out-sloped roads are built with a slight angle of the road surface towards the fill slope. This allows the road surface runoff to sheet flow in a dispersed manner over the fill slope onto the adjacent hillside. Continuously concentrated runoff is avoided. Assuming that the fill slope and hillside are adequately vegetated or otherwise protected, no erosion occurs. Without a ditch, no ditch relief culverts are needed. This minimizes costs, reduces the chance of road failure due to culvert plugging, and may require less road width. Fill slopes may be armored to avoid erosion. Out-sloped roads may be difficult to drain on steep hillslopes and on road grades over 10 to 12 percent. They may be unsafe in areas with slippery soils or snow cover or in places where roads become icy, especially on curves where momentum would carry vehicles to the edge.

Crowned roads disperse water to each side of the road. They often require a system of ditches and cross drains which can be difficult to create and maintain. Therefore, they work best on two-lane roads with gentle grades or on the crest of hills.

UNDERSTANDING THE TYPE OF ROAD NEEDED

Deciding what kinds of roads you need for access to and on your property is an important step towards good stewardship. This includes considering whether or not existing roads are adequately designed for the intended uses. In some cases, existing roads may need to be upgraded to accommodate your uses or entirely new roads may be required.

The appropriate road design depends on the intended use. Roads with relatively high traffic levels, heavy truck use, or all-season use require a higher design standard and possibly a higher level of maintenance. In any case, the guiding principles should be to minimize erosion and ensure that the road is designed and maintained according to its use.

All-season roads

These are used year-round and are intended to be in continuous service for the foreseeable future. In rural subdivisions, these tend to be the "community roads" that run across multiple parcels and collect traffic from individual driveways. On timberlands or ranches, these permanent roads are the "haul roads" that can be used year-round, but receive most traffic during the dry season. Typically, all-season roads have rock

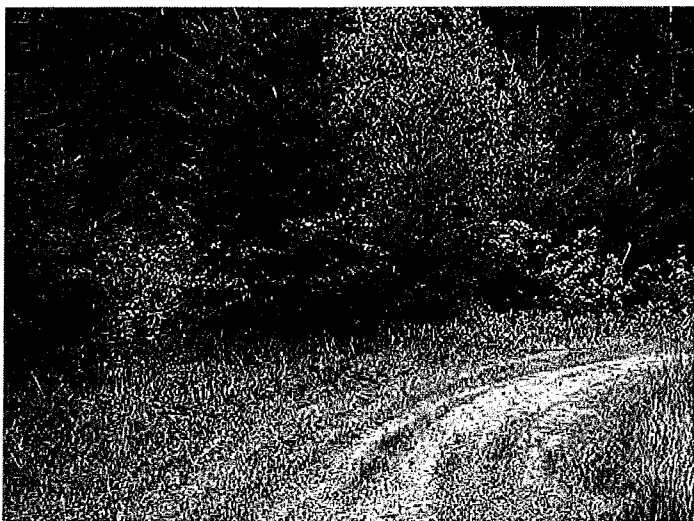

Figure 12. Grass cover on the surface of a road used for dry-season access.
 Source: Julie Bawcom, California Geological Survey.

or other surfacing (at least on steep hills and near stream channels) and bridges or culverts at stream crossings. They may be in-sloped, out-sloped, or crowned alone or in combination. They may be graded and resurfaced regularly to maintain a smooth running surface.

Seasonal roads

These may be constructed to a lower standard because they are used only during the dry season (fig. 12). They are often permanent roads so they require provisions for drainage even if they are not used in the winter. Rock surfacing may not be required. Fords, rather than culverts or bridges, may be used at stream crossings, particularly if the streams do not flow in the summer. Seasonal roads may have a steeper gradient than all-season roads and utilize an out-sloping drainage design.

They may be closed after seasonal use and winterized by installation of water bars and revegetation of the road surface.

Temporary roads

These are used for only a short time and for a dedicated purpose, such as a timber harvest. Use is generally confined to the dry season and design standards may be minimal. Construction should minimize the volume of material excavated by following existing contours and cutting as little as possible. The road is closed after use, although the road bed may be retained for future use. Adequate closure should include removal of stream-crossing structures and associated fills along with installation of water bars to prevent any accumulation of water on the road surface. If vegetation cannot grow back on the road surface, it may be necessary to break up compaction and loosen the soil by 'ripping' it with a bulldozer. When closed, the entrance to the road should be blocked off to prevent all vehicle access.

ROAD DESIGN PRINCIPLES

Construction

- Minimize the number and length of roads in the watershed.
- Minimize the width of the road and the area disturbed during construction.
- Minimize road gradient. Gradient should be 12 percent or less.
- Use balanced cut-and-fill construction in gentle terrain.
- Avoid construction on steep slopes over 60 percent. Use full-bench construction where slopes over 60 percent cannot be avoided.
- Minimize cuts, fills, and vegetation clearing. Construct cut slopes on a $\frac{3}{4}$:1 or flatter slope.
- Build fill slopes on a $1\frac{1}{2}$:1 or flatter slope.

Streams

- Stay as far away from streams as possible and minimize the number of crossings.
- Design crossings with adequate capacity to pass the 100-year storm flow plus the debris and sediment carried through the culvert during the storm.

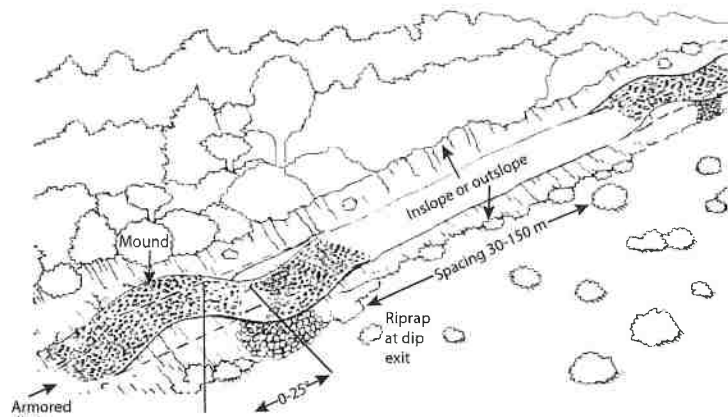

Figure 13A. Rolling dip on an out-sloped road. Proportions are exaggerated for clarity. (In practice, rolling dips can be subtle and still be effective.) Source: Keller and Sherar 2003.

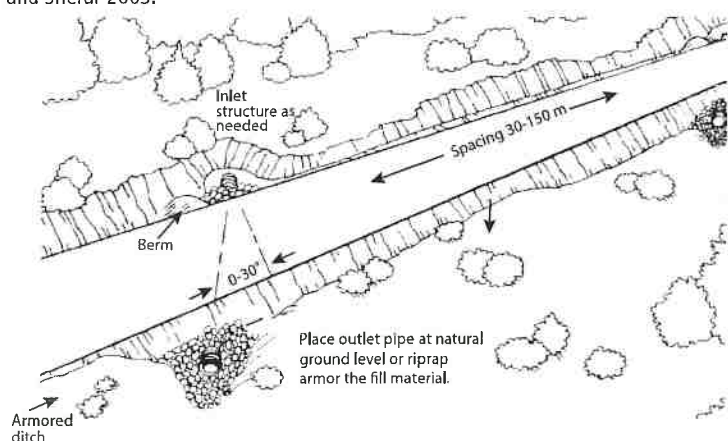

Figure 13B. Installation of ditch relief culverts on an in-sloped road section. Source: Keller and Sherar 2003.

- Reduce the potential for streams to be diverted onto the road surface by installing dips and trash barriers on streams that are not fish bearing.
- Protect crossing outlets with erosion control measures or downspouts.
- Facilitate fish passage, preferably by installing bridges, on fish-bearing streams.
- Use special techniques to cross meadows and other wet areas.

Drainage

- Provide adequate road surface drainage and minimize the concentration of runoff.
- Out-slope roads whenever practical. Road surfaces should slope 3 to 5 percent for road grades less than 10 percent. Install rolling dips for drainage (fig. 13A).
- In-slope road surfaces at an angle of 3 to 5 percent. Install ditch relief culverts (fig. 13B).
- Crown road sections with gentle slopes to prevent standing water on the road.
- Avoid wet and unstable areas.

LOW-VOLUME ROAD DRAINAGE PRINCIPLES

Situating and designing roads correctly from the outset will save a landowner years of worry and maintenance costs caused by avoidable road problems. The key to proper road design is to abide by established guidelines and hire good help. These guidelines can also be used to address maintenance problems on existing roads.

It is often said that the three most important considerations for road design are drainage, drainage, drainage! Drainage features should include ditch relief culverts for in-sloped roads and rolling dips for out-sloped roads. Rolling dips or ditch relief culverts of at least 12 inches in diameter should be spaced as necessary to effectively drain the road, and no further apart than every 400 feet (table 1). Adequate drainage control during the winter is also critical for seasonal and temporary roads. Water bars should be installed every 250 feet or closer when the road is closed (table 2). Drainage features should be spaced more closely on roads with steep grades or erodible soils composed of silt or fine sands. (A conversion table is provided at the end of this publication for calculating equivalents between English and metric systems of measurement.)

Table 1. Rolling dip and ditch relief culvert recommendations

| Road grade (%) | Soil erodibility | |
|----------------|-------------------------------|--------------------|
| | Low to non-erosive soils (ft) | Erosive soils (ft) |
| 0-3 | 400 | 250 |
| 4-6 | 300 | 160 |
| 7-9 | 250 | 130 |
| 10-12 | 200 | 115 |
| 12+ | 160 | 100 |

Source: Adapted from Keller and Sherar 2003.

Table 2. Water bar spacing recommendations

| Road or trail grade (%) | Soil erodibility | |
|-------------------------|-------------------------------|--------------------|
| | Low to non-erosive soils (ft) | Erosive soils (ft) |
| 0-5 | 250 | 130 |
| 6-10 | 200 | 100 |
| 11-15 | 150 | 65 |
| 16-20 | 115 | 50 |
| 21-30 | 100 | 40 |
| 30+ | 50 | 30 |

Source: Adapted from Keller and Sherar 2003.



Figure 14. This fill slope erosion was caused by a plugged cross-drain inlet that diverted ditch flow over the road surface. *Photo: Angela Wilson, Central Valley Regional Water Quality Control Board.*

RECOMMENDED ROAD MAINTENANCE PRACTICES

Even properly designed and constructed roads need inspection and maintenance to function well and avoid road and environmental damage. Maintenance should be performed when needed. The longer the delay in needed maintenance, the more damage will occur and the more costly the repairs will be (fig. 14).

Maintenance should focus on correcting problems that may lead to road failure. This involves ensuring that the established drainage system is not compromised. Culverts plugged with debris often lead to ditch or stream water flowing on to the road surface, which can cause surface erosion or even wash away the entire road prism. Preventing such occurrences should be a top priority. Closing a road during the rainy season can reduce damage caused by vehicles and avoid substantial maintenance costs.

KEY MAINTENANCE PRACTICES

- Inspect roads regularly, especially before the winter season and following heavy rains.
- Keep ditches and culverts free from debris.
- Remove slide material from the road or ditches where it blocks normal drainage.
- Regrade and shape the road surface periodically to maintain proper surface drainage.
 - Keep rolling dips shaped and graded.
 - Keep the downhill side of the road free of berms unless they are intentionally placed to control water or traffic.
 - As necessary, apply surfacing such as aggregate or pavement to protect the roadbed.
- Avoid disturbing soil and vegetation in ditches, shoulders, and on cut-and-fill slopes.
- Maintain an erosion-resistant surfacing such as grass or rock in ditches.
- Close the road during very wet conditions.
- Carry a shovel in your vehicle during the rainy season to clean out ditches, redirect water off the road surface, etc.

The key to good maintenance is identification of maintenance needs through frequent inspections. Road inspections should focus on identifying areas where problems may occur in future storms (fig. 15). All parts of the road including the road surface and cut-and-fill slopes should be inspected, as well as drainage structures such as culverts, bridges, and water bars. Ideally, inspections should be done in time to allow for repairs before the rainy season.

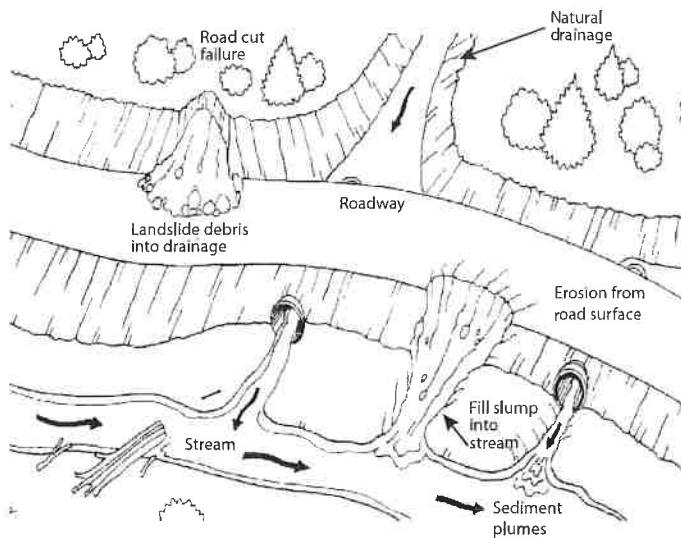

Figure 15. Road system problems to look for during a road inspection.
Source: Keller and Sherar 2003.

WHAT TO LOOK FOR DURING A ROAD INSPECTION

- **Culverts:** Clear debris and sediment from culvert inlets (see figs. 16 and 17). Straighten bent culvert ends. If erosion has occurred at outlets, install energy dissipaters or armoring.
- **Bridges:** Inspect bridge abutments. Remove logs or branches lodged in the bridge structure.
- **Water bars:** Confirm that the water bars are working properly and directing drainage off the side of the road. Inspect the area downslope of the water bars for evidence of rills or gullies indicating that the slope requires additional protection from concentrated roadside drainage.
- **Rolling dips:** If erosion has occurred at the outside edge of the dip, install energy dissipaters or armoring.
- **Inside ditches:** Use a shovel to clear debris from the ditch. Avoid grading in ditches.
- **Cut-and-fill slopes:** Inspect for rilling, slumping, or cracks. Install more drainage structures if problems are found. Remove unstable material with an excavator.



Figure 16. Culvert plugged with sediment at inlet. Photo: Angela Wilson, Central Valley Regional Water Quality Control Board.



Figure 17. Culvert with rusted bottom and breakage caused by sediment. Photo: Angela Wilson, Central Valley Regional Water Quality Control Board.

RECOGNIZING AND FIXING COMMON ROAD PROBLEMS

Many road problems are quite easy to detect because they result in reduced driving comfort (e.g., rutting, potholes or wash boarding, erosion of portions of the roadbed, and deposition of soil on the road surface). Obvious problems such as these may cause impacts to streams and aquatic organisms by, for example, depositing sediment or creating barriers to fish passage. Road treatments can be designed to alleviate problems for traffic as well as aquatic habitat without much additional cost. Appropriate treatments for specific kinds of problems are identified here. Before initiating a treatment on your property, it is advisable to consult a professional erosion control or geotechnical specialist.



Figure 18. Water collecting on a forest road because of poor drainage. *Photo: Jared Gerstein.*

Potholes, Gullies, Extensive Rilling, Mud, and Other Road Surface Problems

Symptom

Potholes, ruts, and mud on the surface of the road are symptoms of drainage problems (fig. 18). A properly designed and maintained road will have very little standing or running water on the road surface, even during rain storms.

Finding the underlying problem

In order to locate the source of the problem, follow the water. Water may be originating from springs in the cut bank or under the road, from small creeks diverted onto the road surface, or from retained rain water due to improper drainage. The problem may also be caused by a combination of these.

First, look for springs on the cutbank or under the road. Water-loving vegetation, such as ferns or rushes, is a good indicator of the existence of springs. After a storm ends, puddles will dry out elsewhere on the road but remain much longer where you have springs. If no springs are found, look for streams diverting water onto the road surface. Small swales that are dry most of the year may flow during rain storms; go look for them while it is raining. Look for the original stream on the downhill side of the road.

If the road is retaining rain water on the surface during and shortly after rains, the road may need to be reshaped in order to drain water more efficiently. It is common for roads

that have been poorly maintained for years to develop berms on one or both sides of the road, preventing water from draining from the road surface.

Solutions

Possible treatments for spring seepage onto roads are installing deeper inboard ditches and culverts to drain the water under the road, building up the road surface with base rock, or others as appropriate. Stream diversions onto the road surface may be treated by installing a culvert or rocked dip to place the stream back in its natural channel. Standing water due to poor drainage should be treated by changing the shape of the road to out-sloped, in-sloped, or crowned. Breach berms at strategic nonerosive locations to allow drainage and prevent their re-creation during grading. Out-sloping roads and installing rolling dips should be done whenever possible. Rock surfacing may also need to be added.

Dysfunctional Ditches

Symptom

One of the liabilities of a ditch system is the possibility of ditches plugging with debris, causing water to flow onto the road surface. Ditch water “captured” by the road surface can cause severe erosion (fig. 19) and even wash out the road completely.

Finding the underlying problem

Water may flow out of a ditch onto a road when the capacity of the ditch is exceeded. This occurs when the volume of runoff exceeds the ditch capacity or, more commonly, when a ditch relief culvert is plugged with debris. In the latter instance, the plugged cul-



Figure 19. Erosion caused by ditch water leaving the ditch and traveling across the road. *Photo: Susan Kocher.*

vert may be located at the point where water flows onto the road or it may be uphill from there. Once the plugged culvert is located, examine its size and alignment. If a culvert plugs regularly, especially with sediment, there may be a design problem. If the culvert is less than 18 inches in diameter, it may be too small. If the culvert is installed at too sharp of an angle at the inlet, ditch water may not be directed into the culvert at high flow. If the cross-drain grade is too flat, sediment may settle out in the culvert rather than passing through it, causing blockage.

Solution

Once the plugged culvert is located, material blocking the culvert inlet should be removed. If this is the first time the culvert has plugged and

the blockage was caused by a recently fallen tree or branch, simply removing the blockage may be sufficient. If the culvert repeatedly plugs, it may be undersized or misaligned and need to be replaced or realigned. In some cases, excess sediment may be evidence of upslope instabilities that need to be addressed.

Symptom

Another liability of ditch systems can be inadequate cross drains. Without a sufficient number of cross drains or ditch relief culverts, ditch water may become increasingly concentrated, gain erosive power, and cause ditch erosion in larger storms. Deeply incised ditches can be a hazard to driving, especially when they become large enough to accommodate a car tire (fig. 20).

Finding the underlying problem

Ditches incise when they carry too much flow for their design capacity and they erode rather than spill water out onto the road. Too much flow in the ditch occurs because there are not enough ditch relief structures and/or because there are sources of water other than road runoff contributing to ditch flow. Examine the ditch system to see if the ditch has captured the flow from a stream channel or spring and diverted it down the ditch. If not, the most likely problem is too few ditch relief culverts or cross drains.



Figure 20. Eroding inboard ditch on an in-sloped road. This is a symptom of inadequate cross drains for conveying ditch flow across the road. *Photo: Richard Harris.*

Solution

Ditch-captured stream channels should be treated by installing a culvert under the road and reconnecting the stream channel to its original course below the road. Problems arising from inadequate drainage should be treated by adding more ditch relief culverts. A more effective long-term solution may be to out-slope the road, if feasible, and remove the ditch altogether. Armoring ditches without treating the underlying drainage problem may reduce erosion in the short term but is not considered a permanent solution.

Symptom

Ditches may become filled in with sediment, rock, or woody debris (fig. 21). This reduces their



Figure 21. Cut bank failure blocking inboard ditch. Cut bank failures cause operational and maintenance problems, especially when chronic. *Source:* Keller and Sherar 2003.

capacity to convey ditch flow. The inlets to ditch relief culverts can become filled with sediment, causing ditch water to flow over and erode the road surface.

Finding the underlying problem

Examine the cut slope along the road to identify the source of the sediment. A slump or failure in the cut slope may have delivered dirt and rocks to the ditch. Or, a tree or branch may have fallen into the ditch, causing sediment to accumulate. Sediment may have accumulated in sections of ditch that have a flat gradient.

Solution

Filled-in ditches should be cleaned out with hand tools or heavy equipment, depending on the scale of the problem. If this is a recurring problem,

the cut slope may need treatment to reduce its chances of slumping. A number of slope stabilization techniques are available and can be developed with the help of a professional erosion control or geotechnical specialist. Road surface sediment can be reduced by rocking the road. A ditch relief culvert may need to be installed before the grade flattens out, to carry water through the culvert before the sediment settles out in the ditch.

Gullies Caused by Roads

Symptom

Gullies are caused when increased or concentrated flow from the road system flows onto erosive soil. Most often, gullies originate from a road system's drainage features. They can be identified by their bare dirt banks and occurrence in places where natural streams do not occur, such as smooth hillslopes or ridges (fig. 22). Gullies may or may not threaten the roadbed itself, but they are always a significant source of sediment and thus a detriment to streams.



Figure 22. Gully caused by through-cut on road at base of steep road section. *Photo:* Jared Gerstein.

Finding the underlying problem

Inspect for gullies at the outlets of ditch relief culverts and rolling dips or where inboard ditches leave the road at a corner. Most gullies are caused by a concentration of water from the road and ditch system. Walk the road system to identify the drainage structures releasing flow that leads to gullies. Gullies can also occur when a stream has been diverted out of its natural channel. If this is the case, it is important to locate the original stream channel by walking up the gully to find where it starts.

Another cause of gullies can be culverts that have been installed improperly, with outlets set on the hillside rather than back in the natural channel. Examine culverts located at the origin of the gully flow to see if misalignment is causing the erosion.

Solution

The solution to gullies is to remove the concentrated flow from the soil it is eroding. Gullies should be dewatered by returning the flow to a controlled conveyance, either back into the ditch or stream system from which the flow escaped, or by realigning the culvert that allowed its escape. Alternatively, flow can be rerouted around the most erosive soils by installing downspouts. The goal of the treatment is typically to stabilize the gully and halt further erosion since it usually is not feasible or cost effective to fill in and restore a gully's original slope.

Stream Crossings

Stream crossings on roads can be the most significant source of sediment to streams. They are also the most likely locations to become impassable during a storm. Because of their importance to both stream health and accessibility, these sites should be carefully watched and maintained. Typical problems include culvert plugging, fill eroding, outlet scouring, and blocking of the migration of fish and other aquatic life such as amphibians.

Symptom

Culverts that convey streams under roads must be large enough to transport the flow plus the tree branches, sediment, and rocks that often accompany the flow during large rain storms (fig. 23). Stream culverts may plug when debris blocks the inlet, allowing water to overtop the crossing and possibly wash out the crossing and road altogether.

Finding the underlying problem

Culverts that plug frequently with debris may be undersized for the flow of the stream and the debris it carries, or they may be misaligned, blocking the flow of water and debris through the culvert. When material collects behind a culvert, it is likely that the culvert is too small.



Figure 23. This culvert is nearly plugged by woody debris, endangering the road.
Photo: Angela Wilson, Central Valley Regional Water Quality Control Board.

Solution

The ideal treatment for an undersized culvert is replacement with a larger one, capable of carrying flow and debris. Appropriately sizing a culvert for the stream and watershed it drains is a fairly technical task and should be done by a knowledgeable professional (Cafferata et al. 2004). In some relatively simple cases, it may be feasible to install trash and debris racks upstream from the culvert to capture and retain the debris so that it does not flow into the culvert (fig. 24). This, however, should be discouraged on fish-bearing watercourses because debris accumulations may become a barrier to migrating fish. Remember that debris racks need to be cleaned regularly to continue to function.

Symptom

Installing a culvert to convey a stream under a road involves placing a significant amount



Figure 24. A trash rack installed upstream to protect a culvert from plugging. Source: Keller and Sherar 2003.

of fill in the channel above and below the culvert, and then building the road base on that fill. The fill over the culvert may erode, narrowing the traveled way (fig. 25).

Finding the underlying problem

Road fill is most often eroded by water plunging from the outlet of a culvert that is too short. “Shotgun” culverts shoot the water down to the streambed while eroding the fill under the culvert. Inspect road culverts at the downslope ends, looking for any that stick out into the air rather than carry their flow to the base of the fill slope.

Solution

The most thorough solution to shotgun culverts is to replace them with longer pipes that are placed at the grade of the natural stream channel rather than high in the fill above the stream. Alternatively, a downspout or rock armor can be added below the outlet if erosion has not been too severe (fig. 26).

Symptom

Culverts may create barriers to fish migration (fig. 27). Problems include excessive water velocity, insufficient water depth, lack of a downstream jump pool, and excessive jump height. Culverts that are relatively



Figure 25. Eroding fill slope and culvert failure due to plugging at inlet and diversion of flow across the road. Photo: Bill Weaver, Pacific Watershed Associates.



Figure 26. Rock armoring at ditch relief culvert outfall to reduce potential for downstream erosion. Note also the berm around the fill slope to prevent road runoff from eroding it. Also, straw mulch has been placed on the fill slope to reduce erosion. Photo: Jared Gerstein.

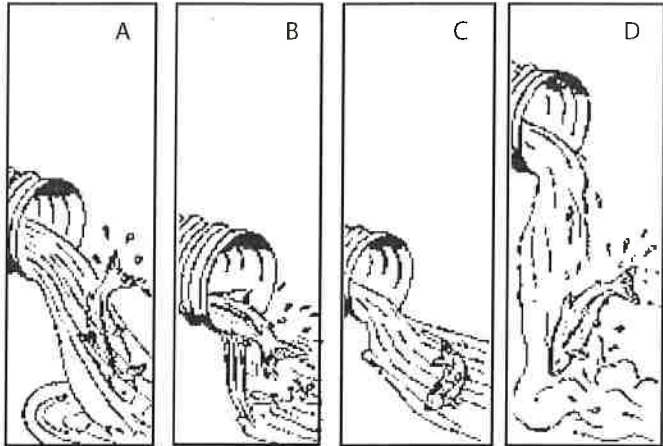

Figure 27. Barriers to fish migration caused by culverts. Source: Keller and Sherar 2003.

small for the size of the stream accelerate the speed of the flow, sometimes rendering it too fast for an adult or juvenile fish to swim against when heading upstream (fig. 27A). Culverts too large for the stream they carry may dissipate the flow to the point where it is too shallow for the fish to navigate (fig. 27B). Culverts with no natural resting place downstream may not allow fish to find a spot from which to make their jump (fig. 27C). Some culverts may be positioned too high above the stream and so require a jump that is too high for an adult or juvenile fish to make (fig. 27D).

Finding the underlying problem

All culverts and bridges over fish-bearing streams should be inspected for the existence of problems such as those shown in figure 27. Some barrier

problems will be quite obvious. Unfortunately, many are not. Therefore, the best way to identify whether your crossings are blocking fish is to consult a fisheries biologist from a state, federal, or local agency.

Solution

Replacement of problem culverts with bridges and arched culverts of adequate size is preferred because they modify the channel less and so avoid many problems that can block migration (fig. 28). Appropriate assistance should be sought in designing and constructing crossings where migrating fish must be accommodated. Contact your local Department of Fish and Game office. In some cases, passage through existing culverts may be improved by installing baffles or weirs to slow and funnel stream water. In other cases, the upstream and/or downstream channels may be modified to create resting pools and reduce the jump height.

GETTING ROAD WORK DONE

There are some things that a landowner can do to maintain his or her roads and there are other actions that are best left to professionals. If you are contemplating new road construction or major road upgrading and you are not experienced with this work, you need to get help. County public works and planning departments, your local California Department of Forestry and Fire Protection or Resource Conservation District office, UC Cooperative Extension Office, and your neighbors may be able to recommend someone who can help you plan and implement a road construction or improvement project. Depending on your location and the type of work, you may even qualify for grants and cost sharing programs (see "Sources").

Before undertaking extensive road work, it is important to have a good plan. You may retain professionals trained in road assessment to evaluate your roads in relation to your land management and use objectives. The objectives might be to reduce maintenance costs, to reduce sediment production, to protect natural resources, or to



Figure 28. An arched pipe installed on a fish-bearing stream to minimize impacts on fish habitat and migration. Source: Keller and Sherar 2003.



Figure 29. Bulldozer clearing out a road ditch. Photo: Jared Gerstein.



Figure 30. Installation of a new culvert after the old one was excavated. Photo: Jared Gerstein.

assure accessibility in all conditions. A road assessment may be used to help decide whether a road is worth maintaining in its current condition and location. Many roads were built in locations because of property boundaries, with little regard for geologic, geomorphic, biologic, or hydrologic conditions. If the road is tied to an easement and there are multiple landowners, relocation may not be an option. If a road is a chronic problem, however, relocation should be considered because it may be the cheapest and most effective remedy. A thorough road assessment will help you decide the best course of action and develop a plan for implementing road work.

Constructing or upgrading a road may require the services of a licensed civil engineer. Especially difficult projects may require other professionals including a licensed geologist or structural engineer. Simpler projects may only require a qualified equipment operator or grading contractor. When choosing an engineer or a contractor, it is important to carefully review their qualifications to do the work, their experience, and their ability to perform on time and on budget. Always ask for references and always follow up by checking them. Never hire someone who is not adequately insured against liabilities resulting from the work. You also want to make sure your contractor is licensed. Get the contractor's license number, and check with the State Contractors Licensing Board to see if there are any complaints or violations for the operator you intend to hire.

Routine road maintenance is another matter and there are many things you can do to ensure that your roads function well under all weather conditions. In some instances when a road is shared by several landowners, there may already be a road association or homeowners' association that is responsible for road maintenance. Generally, if you do not know if you are part of a road association, you probably are not. Road and homeowners' associations assess landowners a fee used to offset costs for road maintenance. The fee is either paid on a yearly basis or as the need for maintenance arises. If you have a neglected road that serves several properties and there is no road maintenance agreement between them, you might consider initiating one. One of the major problems in rural areas is "orphan roads" that no one takes responsibility for maintaining.

For the roads on your property that are your sole responsibility, the key to good maintenance is a system of inspection and record-keeping. Inspections should be performed on all your roads and stream crossings before the winter, during storm events, and after the winter. Use the diagnostic tips previously described to identify

maintenance needs. Simple tasks such as culvert and ditch clearing can be performed by most landowners (fig. 29). More complex tasks, such as roadside brushing, remedial grading repair, or installation of culverts (fig. 30), will probably require outside assistance. Keeping good maintenance records can help landowners evaluate the cost of correcting on-going problems and judge whether road upgrading projects would be cost effective. It is also essential for tax purposes.

ELEMENTS OF GOOD ROAD MAINTENANCE RECORD KEEPING

- Identify and prepare sketch maps of problem areas and treatments applied.
- For each site, describe the problem, when it started, and what caused it.
- Document the things done to fix the problem.
- List the equipment and labor hours needed to fix the problem.
- Quantify the amount of armor or rock imported to fix the problem (cubic yards).
- Quantify the amount of sediment or spoils removed (cubic yards).
- Measure the length, width, and depth of any erosion features.
- Take photos before and after the maintenance activities.

PERMITS FOR ROAD WORK

Depending on where you live, extensive road work may require a grading permit from the county public works or planning department, particularly if the project involves new road construction. Not all counties have grading ordinances but all have stipulations in their building codes that apply to grading for home sites and driveways. These are typically triggered by the extent of planned disturbance. Before undertaking any grading on your property, check with your county planning staff.

If you are planning on crossing or otherwise altering a stream or creek, you may be required to obtain a Streambed Alteration Agreement from the California Department of Fish and Game. Activities requiring these agreements include installing culverts, bridges, or fords; rip-rapping the banks of stream channels; or skidding logs across temporary crossings. Many projects that require a Streambed Alteration Agreement will also require a permit from the U.S. Army Corps of Engineers. If the project involves a stream that has anadromous fish (i.e., salmon, cutthroat trout, or steelhead), additional consultation or permits may be required from the National Marine Fisheries Service or from the U.S. Fish and Wildlife Service. Your local

Department of Fish and Game staff should be aware of the permit requirements of these agencies.



Figure 31. Bulldozer reshaping road surface to out-sloped condition to improve drainage. *Photo: Jared Gerstein.*

ESTABLISHING A WRITTEN CONTRACT FOR ROAD WORK

Landowners should establish a clear written contract for contractors providing road services. Contracts should include the necessary road specifications and standards to be constructed or maintained. The various parts of a new road to be constructed should be listed, including the subgrade and surface and the cut-and-fill slope. The standards to which these should be built, including the width of the subgrade and surface, slope of cut and fill, and depth and size of the base and surface rock, should be specified.

TYPES OF EQUIPMENT USED IN ROAD MAINTENANCE

A variety of heavy equipment may be used when constructing or maintaining a road. *Bulldozers* are often used to make road cuts, shape the road, and develop the subgrade (fig. 31). *Excavators* can be used to replace crossings and develop new road alignments (fig. 32). *Backhoes* have many uses, including replacing small crossings, loading rock, and road shaping. *Graders* are used for final road shaping, spreading surface rock, and smoothing the surface (fig. 33). *Dump trucks* are used to transport rock to the construction site and to haul away any excess cut materials (fig. 33). *Rollers* are specialized to roll over the road surface and compact rock and road materials.

ROAD WORK COSTS

Upgrading an existing road is less expensive than constructing a new one, but may still involve substantial costs. Cost depends on the heavy equipment used, hourly equipment rental or contract rates, the skill and experience of the operator, design standards of the road, and the choice of the specific drainage structures and features to be installed. Examples of costs for road improvements are listed in table 3. When

Table 3. Costs to modify and improve existing roads

| Activity | Ideal equipment | Cost rate* | Production rates [†] | Costs |
|---|--|---|--|--|
| out-sloping road and filling ditch | motor grader with rippers | \$140/hr | 500 ft/hr for a 20 ft wide road | \$280/1,000 ft |
| installing rolling dip | small dozer with rippers (John Deere 450) | \$130/hr | 1 hr each (30 to 40 ft long on flat roads) 2 hr each (50 to 100 ft long on steep roads) | \$130 to \$260 each |
| removing berm or cleaning ditch | motor grader | \$140/hr | 1,000 ft/hr | \$140/1,000 ft |
| rock-surfacing road (1.5 in. minus crushed) | dump truck spread | \$25 to \$50/ yd ³ delivered [‡] | 4 in. deep × 20 ft wide = 250 yd ³ /1,000 ft road | \$6,250 to \$12,500/1,000 ft |
| installing ditch relief culvert (40 ft of 18 in. culvert) | backhoe or tractor, laborer | \$120/hr or \$95/hr | 3 hr each + culvert (\$35/ft + \$25 coupler + \$165 labor) | \$1,950 each |
| installing stream crossing (36 in. × 40 ft culvert with 200 yd ³ fill) | excavator, small dozer, water truck, laborer | \$175/hr \$130/hr \$95/hr \$55/hr | \$2,350 culvert (w/coupler) + \$1,225 excavator + \$910 dozer + \$190 water truck + \$165 labor + \$125 tamper | \$4,965 each |
| installing culvert downspout | hand labor, equipment (>24 in. culvert) | \$55/hr \$125/hr | 2 hr labor for 20 ft × 24 in. 3 hr labor for 40ft × 36 in. | \$110 + materials \$375 + materials |
| straw mulching of bare soils areas | labor | \$55/hr \$7.50/straw bale incl. tax/delivery | 1 bale/600 ft ² to 700 ft ² + spreading at 4 bales/hr | \$36 to \$40/1,000 ft ² |
| upgrading road completely | motor grader, skip loader, dump truck, water truck, riding compactor | \$140/hr \$110/hr \$85/hr \$95/hr \$95/hr | Average mid-slope road requiring stream crossing upgrades | \$45,000 to \$77,000 per mi |

Source: Adapted from CDFG 2004 by Joe Carri Jr.

Notes: *Additional equipment mobilization costs apply (4-hour minimum for small equipment and an 8-hour minimum for large equipment).

[†]Production rates do not account for rocky soil or soft soil conditions.

[‡]Trucking and material costs for bulk rock or sand assume a round trip time from 1 to 2½ hours. Longer hauls require additional trucking costs.



Figure 32. Excavator removing a crossing, including culvert and fill. Photo: Jared Gerstein.



Figure 33. A grader spreading the gravel on the road surface placed by a dump truck. Source: Joe Hoffman, Plumas National Forest.



Figure 34. Outlet of a concrete culvert (30 inches in diameter) before the project. The culvert was placed too high in the fill, resulting in a 10-foot drop to the channel at the outlet. This caused erosion of the road fill and stream banks, eventually undermining the outer section of the culvert. *Photo: Jared Gerstein.*



Figure 35. The culvert was replaced with a metal pipe (48 inches in diameter) at the correct slope. The road surface was lowered, reducing the fill volume by 100 cubic yards. The outlet and fill were armored to prevent future diversion. *Photo: Jared Gerstein.*

using different equipment, the rates for some treatments may differ from those listed here. Tasks accomplished by manual labor, such as culvert downspout installation and straw mulching for erosion control, are much less expensive than tasks requiring heavy equipment. Installing rolling dips is substantially less expensive than installing ditch relief culverts because only one type of equipment and one worker is needed, and there is no culvert to purchase. The most expensive aspect of building or upgrading a permanent rural road is placing rock on the roadbed and road surface. The drainage structures and road shaping need to be done first, but rock surfacing is the final ingredient necessary to make the road durable for year-round travel.

ROAD WORK CASE STUDIES

Some examples of road upgrading projects are described below. These projects were undertaken by private landowners, the U.S. Forest Service, and the University of California.

Tom Long Watershed

The Tom Long Watershed in Humboldt County is like many other rural areas that have been subdivided for residential use. The road system was put in for harvesting timber during the 1950s and '60s. Harvesting was only done during the dry season and roads were only intended to handle seasonal access. In the 1970s the watershed was subdivided into 40-acre parcels with the layout based largely on the location of the original logging roads. No formal road association or methods for funding road betterment or maintenance were established in the subdivision process. After the subdivision, roads were maintained on an emergency basis, meaning that bridges and culverts were only replaced if the road was no longer passable. Roads were rarely graded and rock surfacing was seldom if ever applied. The watershed became notorious for some of the worst roads in the region.

In the late 1990s residents organized in response to the threat of increased water quality regulation and out of exasperation with degraded road conditions. Following an evaluation of the road system, a number of sites were identified for remedial treatment. The highest priority sites were problem roads and crossings nearest the fish-bearing reaches of Tom Long Creek (figs. 34 and 35). Eventually, remedial work included replacing and upgrading 17 culverts and fixing two active creek diversions at a cost of approximately \$120,000. The majority of the work was funded with a combination of local, state, and federal grant dollars intended to improve fisheries and water quality conditions.

These efforts addressed major issues, but road surfacing, drainage, and other needed improvements have not been completed. All this work requires funding, especially for equipment operators, and funds available from grant programs are limited. Gradually, the work will get accom-

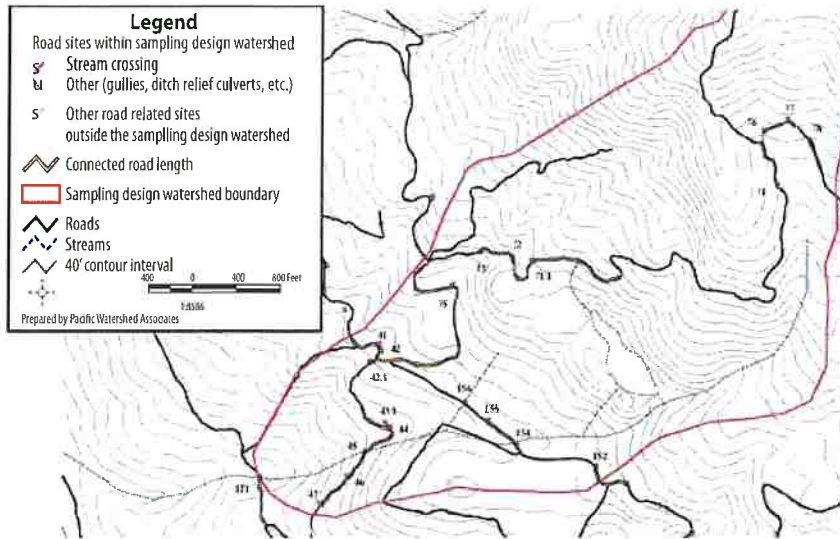

Figure 36. Road upgrading sites at the experimental watershed, Hopland Field Research and Extension Station. Source: Bill Weaver, Pacific Watershed Associates.

plished. As one resident said, “The grant resources enabled us to complete the root canals in the watershed and now we have to find the money to pay for the routine cleanings.”

University of California Hopland Field Station Research and Extension Center

Over a period of about five years, beginning in the late 1990s, the University of California implemented a program to upgrade the road system at Hopland Field Station Research and Extension Center, located in Mendocino County. The work was largely funded by grants from the Department of Fish and Game (1999 SB 271 funds), Fisheries Restoration Grant Program. After an inventory and assessment of roads throughout the

property, over 200 stream crossings and sections of road were prioritized for remedial treatment (fig. 36). Proposed treatments included replacement of culverts, installation of rolling dips and ditch relief culverts, and other measures intended to improve drainage, reduce sediment production, and generally reduce maintenance problems.

The entire program was implemented successfully by 2004. Although some newly installed culverts and fills experienced significant erosion during the first winter after construction, most post-project adjustments have diminished over time. Nearly all treatments have performed well, with a few fill failures at the outlets of rolling dips during spring 2006 (with very high precipitation). Maintenance needs and costs have declined dramatically. Personnel at the Field Station Center are especially satisfied with the superior performance of rolling dips as an alternative to cross drains for both reducing maintenance requirements and adequately draining road surfaces.

Pinchard Creek Project

The U.S. Forest Service partnered with Sierra Pacific Industries and Plumas County to upgrade a section of national forest road with serious erosion problems. The road’s native surface was very erosive and lacked drainage structures. The surface was heavily rutted with rills over 2 inches deep and over 20 feet long (fig. 37). Road cut banks were unstable and eroding with more than 5 cubic yards of material moved, 40 percent of which was delivered to the stream channel. Roadside ditches were overloaded and degrading. One stream-crossing culvert entrance was more than 30 percent blocked with sediment and debris.

The project involved out-sloping the road surface, covering it with crushed rock, and installing drainage dips (fig. 38). Two years after the completion of the project, no surface ruts or road bank erosion has occurred, roadside drainage ditches are stable with little or no sediment delivery to the stream, and culvert entrances remain clear (fig. 39). The cost of the project was \$221,603, with 35 percent from National Forest road maintenance funds, 9 percent from Sierra Pacific Industries, and 56 percent from the Plumas County Resource Advisory Committee.



Figure 37. Pinchard Creek road with rilling along the road surface before the project, 2002. *Photo: Joe Hoffman, Plumas National Forest.*



Figure 38. Pinchard Creek road immediately after project construction, 2002. *Photo: Joe Hoffman, Plumas National Forest.*



Figure 39. Pinchard Creek road two years after project construction, 2004. Note that the road surface remains in good shape without additional maintenance. *Photo: Joe Hoffman, Plumas National Forest.*

BEST MANAGEMENT PRACTICES DURING CONSTRUCTION

Construction of a new road necessarily involves a great deal of earth moving and soil disturbance. It is important that construction be managed wisely to avoid environmental impacts and damage to your property. One important thing a landowner can do is visit the site regularly during construction to ensure that the job is being done correctly. Sometimes plans made before construction are no longer feasible due to site constraints, and new decisions must be made. You need to be accessible to your contractor to help make these decisions when the situation arises.

Some general principles for best practices during construction are listed below:

- Minimize grading and soil disturbance.
- Develop an erosion control plan that includes measures on cut-and-fill slopes, drainage outlets, and disturbed areas (fig. 40).
- Avoid construction and soil disturbance in the winter.
- If construction does occur in the rainy season, ensure that the site has been storm proofed with erosion control measures when rains are forecast.
- Avoid incorporating logs or brush in the fill slope.
- Haul away excess sediment generated rather than side cast it onto the slope.
- Locate any stockpiled sediment in areas where it can be protected from erosion and will not deliver sediment to streams.
- Do not service or fuel heavy equipment where spills could enter a watercourse.

POST-PROJECT ADJUSTMENT

No matter how well planned and executed a road project has been, winter rains and traffic will lead to some adjustment of the final as-built condition during the first winter after improvements are made. Assuming that the road is in otherwise stable terrain, the adjustments will usually be minor and easily corrected. Adjustments may include some erosion of cut-and-fill slopes or culvert inlets and outlets (fig. 41). Road inspections should be done frequently during the new road's first winter season to identify any emerging problems for remediation. Developing problems may be averted with timely action. Plan for follow-up maintenance and put aside funds to perform the maintenance.



Figure 40. Using a portable blower to spread straw mulch on a disturbed road site. *Photo:* Julie Bawcom, California Geological Survey.



Figure 41. Fill surface erosion occurring after a road upgrading project. *Photo:* Bill Weaver, Pacific Watershed Associates.

SOURCES

For information on grants and cost sharing programs, check the online guides at

<http://ceres.ca.gov/foreststeward/html/financial.html>

<http://www.calwatershedfunds.org/>

http://cwp.resources.ca.gov/grant_programs.html

For more information on road design and maintenance, consult the following resources:

Caferrata, P., T. Spittler, M. Wopat, G. Bundros, and S. Flanagan. 2004. Designing watercourse crossings for passage of 100-year flood flows, wood and sediment. California Forestry Report No. 1. Sacramento: California Department of Forestry and Fire Protection.

California Department of Forestry and Fire Protection (CAL FIRE). 2003. The changing California: Forest and range 2003 assessment. Sacramento: Fire and Resource Assessment Program (FRAP).

California Department of Fish and Game (CAL FIRE). 2004. Salmonid stream habitat restoration manual, part X: Upslope assessment and restoration practices. Sacramento: California Department of Fish and Game, Inland Fisheries Division.

Keller, G., and J. Sherar. 2003. Low volume roads engineering: Best management practices field guide. USDA Forest Service/USAID. National Transportation Library Web site, http://ntl.bts.gov/lib/24000/24600/24650/Index_BMP_Field_Guide.htm

Kramer, B. 2001. Forest road contracting, construction, and maintenance for small woodland owners. Research Contribution No. 35, Corvallis: Oregon State University, Forest Research Laboratory.

USDA Forest Service. Riparian roads video short course. Oregon State University Forestry Sciences Laboratory Web site, <http://www.fsl.orst.edu/geowater/RRR/>.

Weaver, W. E., and D. K. Hagans. 1994. The handbook for forest and ranch roads: A guide for planning, designing, constructing, reconstructing, maintaining and closing wildland roads. Ukiah, California: Pacific Watershed Associates for the Mendocino County Resource Conservation District.

Wiest, R. L. 1998. A landowner's guide to building forest access roads. Radnor, PA: U.S. Department of Agriculture, Forest Service. Northeastern Area, State and Private Forestry NA-TP-06-98.

Metric Equivalents

| English unit | Metric equivalent |
|--------------|-----------------------|
| 1 inch (in) | 2.54 centimeters (cm) |
| 1 foot (ft) | 0.3048 meters (m) |
| 1 mile (mi) | 1.609 kilometers (km) |
| 1 acre | 0.4047 hectares (ha) |

FOR FURTHER INFORMATION

To order or obtain printed ANR publications and other products, visit the ANR Communication Services online catalog at <http://anrcatalog.ucdavis.edu>. You can also place orders by mail, phone, or FAX, or request a printed catalog of our products from

University of California
 Agriculture and Natural Resources
 Communication Services
 6701 San Pablo Avenue, 2nd Floor
 Oakland, California 94608-1239
 Telephone: (800) 994-8849 or (510) 642-2431
 FAX: (510) 643-5470
 E-mail inquiries: danrcs@ucdavis.edu

An electronic version of this publication is available on the ANR Communication Services Web site at <http://anrcatalog.ucdavis.edu>.

Publication 8262

ISBN-13: 978-1-60107-483-6

© 2007 by The Regents of the University of California, Division of Agriculture and Natural Resources. All rights reserved.

To simplify information, trade names of products have been used. No endorsement of named or illustrated products is intended, nor is criticism implied of similar products that are not mentioned or illustrated.

The University of California prohibits discrimination or harassment of any person on the basis of race, color, national origin, religion, sex, gender identity, pregnancy (including childbirth, and medical conditions related to pregnancy or childbirth), physical or mental disability, medical condition (cancer-related or genetic characteristics), ancestry, marital status, age, sexual orientation, citizenship, or status as a covered veteran (covered veterans are special disabled veterans, recently separated veterans, Vietnam era veterans, or any other veterans who served on active duty during a war or in a campaign or expedition for which a campaign badge has been authorized) in any of its programs or activities. University policy is intended to be consistent with the provisions of applicable State and Federal laws.

Inquiries regarding the University's nondiscrimination policies may be directed to the Affirmative Action/Staff Personnel Services Director, University of California, Agriculture and Natural Resources, 1111 Franklin Street, 6th Floor, Oakland, CA 94607-5201, (510) 987-0096. For a free catalog of other publications, call (800) 994-8849. For help downloading this publication, call (530) 297-4445.



This publication has been anonymously peer reviewed for technical accuracy by University of California scientists and other qualified professionals. This review process was managed by the ANR Associate Editor for Natural Resources.

pr-8/07-LR/CM