

Site Management Plan

(Tier 2, High Risk)

WDID- 1_12CC405506

Humboldt County
APN: 221-240-015-000, 221-240-014-000

Prepared by:



165 South Fortuna Boulevard, Fortuna, CA 95540
707-725-1897 • fax 707-725-0972
trc@timberlandresource.com

5/22/2019

Revised: 6/24/2020

Arrangement of Document Contents

- **Purpose**
- **Tier Designation**
- **Scope of Report**
- **Methods**
- **Property Description**
- **Project Description**
- **General Location Map**
- **Additional Project Permitting**
- **General Compliance Guide for Cannabis Cultivators**
 - Land Development and Maintenance, Erosion Control, and Drainage Features
 - Cleanup, Restoration, and Mitigation
 - Stream Crossing Installation and Maintenance
 - Soil Disposal and Spoils Management
 - Riparian and Wetland Protection and Management
 - Water Storage and Use
 - Fertilizers, Pesticides, and Petroleum Products
 - Cultivation Related Waste
 - Refuse and Domestic Waste
 - Annual Winterization Measures
- **Statement of Limitations**
- **Site Maps**
- **Implementation Schedule**
- **Mitigation Report tables**
- **Applicable BPTC's (BMP's)**
- **Monitoring Plan**
- **Attachments**
- **Applicable Technical Documents**
 - Site Management Plan (SMP)
 - Disturbed Area Stabilization Plan (DASP)
- **Pictures**

Purpose

This Site Management Plan (SMP) has been prepared on behalf of the cannabis cultivator for the Humboldt County property identified as assessor parcel numbers 221-240-015-000, 221-240-014-000, by agreement and in response to the State Water Resources Control Board Cannabis Cultivation Policy (Cannabis Policy), in congruence with Order WQ 2019-0001-DWQ General Waste Discharge Requirements for Discharges of Waste Associated with Cannabis Cultivation Activities (General Order). The General Order implements the Cannabis Policy requirements, specifically those requirements that address waste discharges associated with cannabis cultivation activities. Cannabis cultivators covered under the General Order are subject to the requirements of the Cannabis Policy in its entirety. The Cannabis Policy provides a statewide tiered approach for permitting discharges and threatened discharges of waste from cannabis cultivation and associated activities, establishes a personal use exemption standard, and provides conditional exemption criteria for activities with a low threat to water quality.

Tier Designation

Tiers are defined by the amount of disturbed area. Tier 1 outdoor commercial cultivation activities disturb an area equal to or greater than 2,000 square feet and less than 1 acre (43,560 square feet). Tier 2 outdoor commercial cultivation activities disturb an area equal to or greater than 1 acre. Risk designation for Tier 1 and Tier 2 enrollees under the Cannabis Policy is based on the slope of disturbed areas and the proximity to a surface water body. Characterization is based on the risk designation summarized in Table 1 below.

Table 1: Summary of Risk Designation

Low Risk	Moderate Risk	High Risk
<ul style="list-style-type: none"> • No portion of the disturbed area is located on a slope greater than 30 percent, and • All of the disturbed area complies with the setback requirements. 	<ul style="list-style-type: none"> • Any portion of the disturbed area is located on a slope greater than 30 percent, and • All of the disturbed area complies with the setback requirements. 	<ul style="list-style-type: none"> • Any portion of the disturbed area is located within the setback requirements.

Thorough assessment of the project area including roads, disturbed areas, legacy features, and cultivation areas classify this enrollment into the **Tier 2, High Risk** designation.

Scope of Report

Tier 1 and Tier 2 cannabis cultivators are required to submit and implement a Site Management Plan that describes how they are complying with the Requirements listed in Attachment A. The description shall describe how all applicable Best Practicable Treatment or Control (BPTC) measures are implemented. Cannabis cultivators within the North Coast Regional Water Quality Control Board jurisdiction are required to submit and implement Site Management Plans that describe how the Requirements are implemented property-wide, to include legacy activities. The SMP includes an Implementation Schedule to achieve compliance, but all work must be completed by the onset of the Winter Period each year. Projects designated as Moderate Risk are also required to have a Site Erosion and Sediment Control (plan) to achieve the goal of minimizing the discharge of sediment off-site. Projects designated as High Risk are also required to have a Disturbed Area Stabilization Plan to achieve the goal of stabilizing the disturbed area to minimize the discharge of sediment off-site and comply with the setback requirements. The cannabis cultivator shall ensure that all site operating personnel are familiar with the contents of the General Order and all technical reports prepared for the property. Projects which have over one acre of cannabis cultivation (total canopy area) are also required to have a Nitrogen Management Plan to describe how nitrogen is stored, used, and applied to crops in a way that is protective of water quality. A copy of the General Order, and technical reports required by the General Order, shall be kept at the cultivation site. Electronic copies of these documents are acceptable. Either format of maintained documents kept on site must be immediately presentable upon request.

Methods

The methods used to develop this SMP include both field and office components. The office component consisted of aerial photography review and interpretation, existing USGS quad map review, GIS mapping of field data, review of on-site photography points, streamflow calculations, general planning, and information gathered from the cannabis cultivator and/or landowner. The field component included mapping of all access roads, vehicle parking areas, Waters of the State, stream crossings, drainage features, cultivation sites, buildings, disturbed areas, and all other relevant site features within the project area and surrounding areas (as feasible). Cultivation areas, associated facilities, roads, and other developed and/or disturbed areas were assessed for discharges and related controllable water quality factors from the activities listed in the General Order. The field assessment also included an evaluation and determination of compliance with all applicable BPTC's per Section 2 of the General Order.

Property Description

The property assessed consists of two contiguous parcels totaling 220 acres located approximately 2.5 miles north of Briceland, California, at an elevation of approximately 1,500 feet above mean sea level. The property is located in Section 1, T4S, R2E, HB&M, Humboldt County, from the Ettersburg USGS 7.5' Quad. The property contains unnamed Class II and III watercourse that drain to Seely Creek, Redwood Creek, and the South Fork Eel River.

Project Description

Cannabis cultivation on the property consists of three 24' x 100', two 24' x 105, 24' x 90', 24' x 70', 24' x 50' greenhouses and approximately 10,000 ft², for a total, general cultivation area¹ of 27,280 ft². The cultivation areas are located within 35,420 ft² of disturbed area, which are located four separate areas on the property. There is a total of approximately 47,098 ft² of disturbed area on the property. This project being permitted by Humboldt County to cultivate to cultivate cannabis. This project was previously enrolled in the North Coast Regional Water Quality Control Board Order No. R1-2015-0023 under WDID-1B161030CHUM and has since enrolled with State Water Recourses Control Board as WDID-1_12CC405506. This project is being classified as Tier 2, High Risk.

Table 1: Cultivation Site Parameters.

Cultivation Area	Land Disturbance Area (ft ²)	General Cultivation Area ¹ (ft ²)	Adjoining Hillslopes (% Grade)
A	5,000	2,880	10 – 15%
B	6,500	2,520	10 – 15%
C	11,720	4,680	10 – 20%
D	12,200	7,200	20 – 30%
E	11,670	6,171	15 – 30%
Relocation Area	~11,470	~6,171	25 – 30%
Totals:	47,098	27,280	

¹ Area refers to the total land disturbance area. The total cannabis canopy area may vary considerably than the disturbance area.

Table 2: Project Permitting

Additional Required Permits Related to Project, Type, and Status	
SIUR	Small Irrigation and Use Registration Filed with Division of Water Rights – #H500765
LSAA/1600	Lake and Streambed Alteration Final Agreements from CDFW – Notification No. 1600-2017-0296-R1 & 1600-2016-0020-R1
401	Required
404	Issued for work under LSAA 1600-2016-0020-R1 – File Name: 2017-00358N

¹ General cultivation area refers to definable areas or groupings of closely situated cannabis cultivation. This designation does not, in any way, reflect the actual cannabis canopy area permitted or present during the assessment of the project area.

Site Management Plan

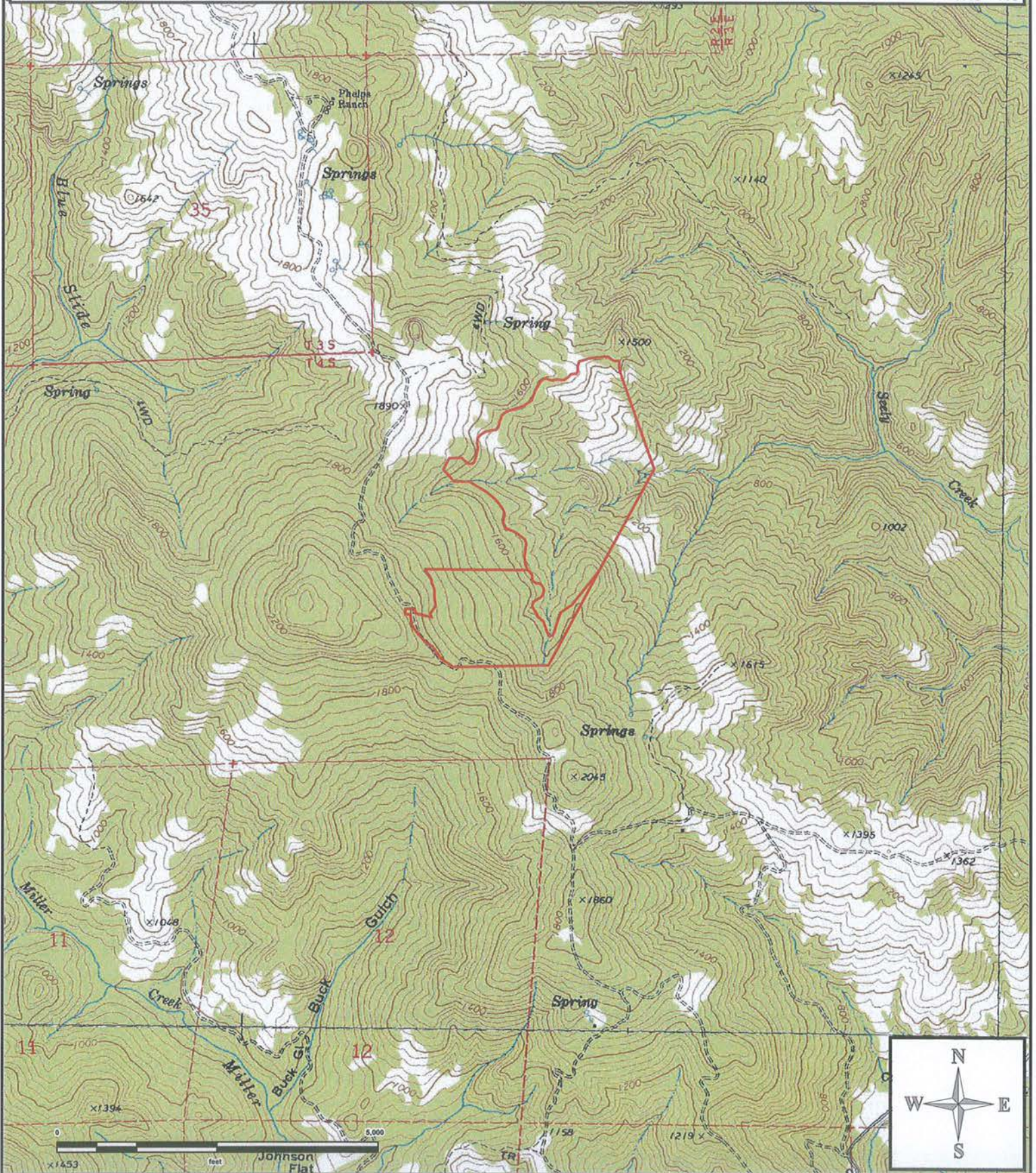
General Location Map [WDID - 1_12CC405506]



 Property Boundary

Located in Section 1, T4S, R2E, HB&M, Humboldt County, from the Ettersburg 7.5' USGS Quad Map

TRC - 113



Baseline Assessment of Requirements Related to Water Diversions and Waste Discharge for Cannabis Cultivation

This project was previously enrolled in the North Coast Regional Water Quality Control Board Order No. 2015-0023. A Water Resource Protection Plan (WRPP) was prepared by Timberland Resource Consultants. Some mitigations prescribed in the WRPP have since been completed. A re-assessment of the project was conducted and will be used as the baseline assessment for the preparation of this document.

Land Development and Maintenance, Erosion Control, and Drainage Features

Project Compliance Y/N

Roads are being classified as “permanent” (roads appurtenant to the project being used year-round), “seasonal” (roads appurtenant to the project being used primarily during summer months), “legacy” (roads not appurtenant to the project receiving little to no use), and “trail” (being rarely used for occasional access to features on the property).

Roads within the project area appear to have a low native rock component and high imported rock component and, based on observations of surface erosion relative to current surface drainage break frequency, are being classified as having moderate erodibility. This classification will be utilized to determine surface/ditch-line drainage break frequency based on Table 19 of the Handbook for Forest Ranch and Rural Roads, 2014.

TABLE 19. Recommended maximum rolling dip and ditch relief culvert spacing, in feet, based on road gradient and soil erodibility ^{1,2}

Soil erodibility	Road gradient (%) and drainage structure spacing (feet)				
	0-3	4-6	7-9	10-12	>12
High to moderate	250	160	130	115	100
Low	400	300	250	200	160

Currently, all permanent roads on the property have imported rock surfacing and do not require any more rock surfacing.

Roads assessed by TRC were found to be in acceptable condition with imported rock surfacing. The majority of access roads, permanent and seasonal, are out-sloped with gentle gradients and adequately drained to allow surface/ditch-line water drainage. However, sections of permanent roads, seasonal roads, legacy roads, and trails require either the maintenance of existing drainage features or installation of new drainage features. No wheel ruts were observed on the majority of access roads on the date of the site visit. Only at Site 53 & 78 were wheel ruts observed. At Site 53, wheel ruts exist for only approximately 50 feet to access a newly construed shed. At Site 78, wheel ruts exist for only approximately 30 feet on a seasonal access road.

Sections of Elk Ridge Road that border along the western property boundaries were also assessed by TRC. Sections of Elk Ridge Road that border the property boundaries that are not used to access the property were assessed and are adequately surfaced and drained, with adequate culverted

watercourse crossings. Only sections of this road that are used to access the property will be included in this report. Elk Ridge Road is maintained by a road owners association, which regularly maintains the road that border the project property. Treatments prescribed in this report may or may not be performed by, or in conjunction with, the road owner's association. See the Mitigation Report and Site Map to follow for site specific details and treatment schedules.

Controllable Sediment Delivery Sites (CSDS) were found on the property. Runoff and sediment from Sites 03, 07, 11, 18, 29, 46, 53, and 55 was found discharging into surface waters. See the Mitigation Report, Treatment Implementation Schedule, and Site Map to follow for site specific details.

Cultivation Areas:

Disturbed Areas associated with Cultivation Areas C & E are located on natural hill slopes less than 30%. Disturbed areas associated with Cultivation Areas A, B, & D are located where adjacent natural adjoining hillslopes are greater than 30% while the cultivation areas themselves are located on much gentler slopes (5 – 30%). Cultivation consists of above ground beds within permanent greenhouses. Cultivation in these areas warrants this project to be classified as moderate risk. However, because these cultivation areas are located along the tops and saddles of ridge lines in locations where the parent material consists of a high content of clast angular rock with outcrops of competent bedrock nearby. It is likely that this same bedrock is also located at a shallow depth below the soil surface in these cultivation areas. The cutbanks and fillslopes associated with these disturbed areas appear very competent with little to no degradation, erosion, or sloughing since its original construction. These areas have also been treated with erosion control measures effectively. No evidence of instability such as surface cracks in soil, slumping side slopes, bulging soil, sunken roads, downslope leaning trees, trees showing characteristic corrective growth features, or vegetation types common to unstable features were observed at any location in or within the immediate vicinity around these cultivation areas. As such, we are not, and believe it does not warrant, classifying this project as moderate risk. The project will continue to be monitored throughout its enrollment. Should this cultivation area begin to exhibit any of the aforementioned indications of potential instability the risk level may be re-evaluated at that time.

Cultivation Area E:

Portions of Cultivation Area E, and associated disturbed areas, are located within the riparian setbacks of a Class II watercourse. Cultivation here consists of potted plants in tightly spaced rows. No erosion or sediment discharge was observed with this cultivation area or associated disturbed area. No riparian vegetation or trees were removed during the construction of this cultivation area. This cultivation area is planned to be relocated to an environmentally superior location, as shown on the attached Site Maps, once Humboldt County cultivation permit is approved. Until then, Humboldt County allows continued cultivation within riparian setbacks. Because the cultivator has chosen to continue cultivating within riparian setbacks, this project is being upgraded to High Risk. Previously this project was designated as Low Risk because the cultivator was not actively cultivating within setbacks and no disturbed area existed.

Past Cultivation Areas:

Cannabis cultivation previously took place at these cultivation areas from approximately 2011 to 2016 and their use has since been discontinued. Cultivation related soils were left in place in their existing beds at the northern most past cultivation area and allowed to be vegetated naturally. Cultivation related soils, pots, and fencing were left in place at the southernmost past cultivation areas and shall be removed as they are located within the riparian buffer areas of an adjacent Class II watercourse. These cultivation areas have since revegetated naturally with no erosion observed. Remaining required decommissioning work involves removing any remaining pots or other cultivation-related wastes from these areas, contouring remaining cultivation-related soils onto the ground outside of any riparian buffer areas, and seeding and mulching the contoured soils or any other disturbed soils associated with removal of these cultivation areas. See "Past Cultivation Areas" in the Mitigation Report and Site Map to follow for site specific details and treatment schedules.

3-acre Conversion Area:

A 3-acre conversion was completed on this property. The conversion area is/was planned to be used as an area for a water storage pond and additional and relocated cultivation areas. Neither of these have occurred yet due to pending permitting of existing cultivation activities and limitations of further development. The conversion area is located along the top and saddle of a ridge line, far from any surface waters, in a location where the parent material consists of a high content of clast angular rock with outcrops of competent bedrock nearby. It is likely that this same bedrock is also located at a shallow depth below the soil surface in this area. The cutbanks and fillslopes associated with the disturbed area appears very competent with little to no degradation, erosion, or sloughing since its original construction. However, erosion in the form of rilling was observed with gullying beginning on fillslopes. See "3-acre Conversion Area" in the Mitigation Report and Site Map to follow for site specific details and treatment schedules.

One unstable area was observed on the property. This unstable area was mapped using a combination of on the ground observations and air photography and consists of a deep-seated slope failure with a permanent access road intersecting the upper bounds of the unstable area. This unstable area was last active when a section of the road fillslope and shoulder moved during the winter of 2016/2017. Currently, the road is in-sloped and drained via a ditch-line to prevent road surface runoff from draining onto the unstable area. See "Unstable Area" on attached Site Maps.

Cleanup, Restoration, and Mitigation:

Project Compliance Y/N

No revegetation besides seeding and mulching disturbed areas or sites are being prescribed.

Stream Crossing Installation and Maintenance:Project Compliance Y/N

Twenty-four watercourse crossings were identified during the assessment of the property. Nine crossings (Sites 12, 20, 21, 28, 30, 31, 32, 33, 45, 79, & 80) shall be removed as the existing culverts are undersized for a 100-year storm event and/or these crossings are not used or required by the landowner. Nine watercourse crossings (Sites 13, 14, 44, 47, 58, 67, 81, 84, & 85) shall be upgraded as the existing culverts are undersized for a 100-year storm event and these crossings are used and required by the landowner. Two crossing areas (Sites 11 & 12 and Sites 30, 31, 32 & 33) are multi-site areas where watercourses are being diverted down inside ditches, resulting in erosion of the inside ditch, and sediment discharge to surface waters. Two other crossing areas (Sites 50, 51, & 52 and Site 70) are also multi-site areas where ephemeral watercourses are being diverted down inside ditches, but are not resulting in erosion of the inside ditch and are not discharging sediment to surface waters.

Two Lake and Streambed Alteration Agreements (LSAA/1600) with California Department of Fish & Wildlife (CDFW) have been finalized as of the writing of this assessment for some of the proposed work on watercourse crossings. Work in watercourses at Sites 11, 12, 13, 21, 28, 33, 44, 45, 47, 58, 81, 84, 85, and the Point of Diversion (POD) on APN 221-240-014 will require an amendment to an existing LSAA/1600 or a new LSAA/1600 with CDFW. Any additional guidelines, treatments, or restrictions set forth under the finalized Lake and Stream Agreement shall be followed.

Table 3: Stream Crossing Hydrology

Site	(ac)		Elevation (ft)	Elevation (ft)	(mi)	(in)
ID_NUMBER	D_AREA	K_VALUE	Culvert_Elevation	Drainage_Divide	LENGTH	CMP_DIA
12	185	0.35	1120	2300	1.1	48
13	135	0.35	1320	2300	0.92	48
14	29	0.35	1320	2240	0.72	24
15	29	0.35	1360	2240	0.72	36
20	113	0.35	1240	2380	0.918	36
21N	7	0.35	1240	1500	0.29	24
21A	20	0.35	1240	1760	0.46	24
26	1	0.35	1160	1240	0.07	24
28	137	0.35	1120	2380	1.02	48
44	93	0.35	1520	2380	0.64	36
45	6	0.35	1560	1760	0.146	24
47	11	0.35	1640	1900	0.21	18
50	9	0.35	1520	1840	0.56	24
52	7	0.35	1520	2300	0.56	24
58	22	0.35	1520	2080	0.4	24
66	38	0.35	1580	2200	0.46	48
67	2	0.35	1560	1760	0.13	10
70	31	0.35	1560	2040	0.29	48
81	3	0.35	2040	2200	0.12	6
84	7	0.35	1920	2200	0.2	12
85	6	0.35	1960	2200	0.17	12

Precipitation Depth-Duration-Frequency Values					Mean Annual Rainfall (in) =		62
50-Year Storm			100-Year Storm				
Time, Min	Depth (in)	Inch/hr.	Time, Min.	Depth (in)	Inch/hr.		
10	0.400	2.40	10	0.583	3.50		

Table 3: Stream Crossing Hydrology (continued)

ID#	Runoff Coef. (K)	Altitude Index (1000's ft.)	Time of Concen. (min)	24-hr. Rainfall Intensity (in/hr)	Mean Annual Rainfall (in)	Drainage Area (ac)	Selected Discharge Method	Q 100	
								RATIONAL (cfs)	USGS MF (cfs)
12	0.35	0.0	11	3.25	62	185	USGS MF	211	164
13	0.35	0.0	10	3.50	62	135	USGS MF	165	125
14	0.35	0.0	8	3.50	62	29	USGS MF	36	33
15	0.35	0.0	8	3.50	62	29	USGS MF	36	33
20	0.35	0.0	9	3.50	62	113	USGS MF	138	107
21N	0.35	0.0	4	3.50	62	7	RATIONAL	9	10
21A	0.35	0.0	6	3.50	62	20	RATIONAL	24	24
26	0.35	0.0	1	3.50	62	1	RATIONAL	1	2
28	0.35	0.0	10	3.50	62	137	USGS MF	168	127
44	0.35	0.0	7	3.50	62	93	USGS MF	114	91
45	0.35	0.0	2	3.50	62	6	RATIONAL	7	8
47	0.35	0.0	3	3.50	62	11	RATIONAL	13	14
50	0.35	0.0	9	3.50	62	9	RATIONAL	10	11
52	0.35	0.0	6	3.50	62	7	RATIONAL	9	10
58	0.35	0.0	5	3.50	62	22	RATIONAL	27	26
66	0.35	0.0	5	3.50	62	38	USGS MF	47	42
67	0.35	0.0	2	3.50	62	2	RATIONAL	2	3
70	0.35	0.0	3	3.50	62	31	USGS MF	38	35
81	0.35	0.0	2	3.50	62	3	RATIONAL	4	5
84	0.35	0.0	3	3.50	62	7	RATIONAL	9	10
85	0.35	0.0	2	3.50	62	6	RATIONAL	7	8

ID#	Existing Culvert (D)	Headwall (HW)	Selected Discharge Method	Q100 (cfs)	Culvert Capacity (cfs)	Culvert is Undersized	Recommended Culvert Dia. (in)	Recommendation Based On
	Diameter (in)	Height (in)						
12	48	0	USGS MF	164	66	TRUE	96	Q100
13	48	0	USGS MF	125	66	TRUE	84	Q100
14	24	0	USGS MF	33	12	TRUE	54	Q100
15	36	0	USGS MF	33	32	TRUE	54	Q100
20	36	0	USGS MF	107	32	TRUE	72	Q100
21N	24	0	RATIONAL	9	12	TRUE	30	Q100
21A	24	0	RATIONAL	24	12	TRUE	42	Q100
26	24	0	RATIONAL	1	12		18	Q100
28	48	0	USGS MF	127	66	TRUE	84	Q100
44	36	0	USGS MF	91	32	TRUE	72	Q100
45	24	0	RATIONAL	7	12		24	Q100
47	18	0	RATIONAL	13	6	TRUE	36	Q100
50	24	0	RATIONAL	10	12	TRUE	30	Q100
52	24	0	RATIONAL	9	12	TRUE	30	Q100
58	24	0	RATIONAL	27	12	TRUE	42	Q100
66	48	0	USGS MF	42	66		48	Q100
67	10	0	RATIONAL	2	0	TRUE	24	Q100
70	48	0	USGS MF	35	66		48	Q100
81	6	0	RATIONAL	4	0	TRUE	18	Q100
84	12	0	RATIONAL	9	0	TRUE	30	Q100
85	12	0	RATIONAL	7	0	TRUE	30	Q100

Soil Disposal and Spoils Management:Project Compliance Y/N

Currently, no spoils are present on the property. Any/all spoils generated through development or maintenance of roads, driveways, earthen fill pads, or other cleared or filled areas have not been sidecast in any location where they can enter or be transported to surface waters. Any/all future spoils generated as a result of any future construction projects that are to be stored on the property shall be done so in accordance with the BTPC.

Riparian and Wetland Protection and Management:Project Compliance Y/N

Upon original assessment of the project and completion of the Site Management Plan, no disturbed areas were identified as being within the riparian areas and this project was not designated a "High Risk" project. However the cultivator, upon learning from Humboldt County that immediate relocation of Cultivation Area E (previously designated a Past Cultivation Area) was not possible and that the taxes associated with this cultivation area would still be due regardless of if this area was cultivated or not, decided to resume cultivation area until it could be relocated. Because of this, this project is now being designated as a "High Risk" project until this now active cultivation area can be relocated. Upon approval of and relocation of Cultivation Area E, all cultivation-related materials and wastes will be removed and either be re-used, stored in an adequately in a contained manner, or properly disposed of. See the Mitigation Report, Treatment Implementation Schedule, and Site Map to follow for site specific details.

Also, there are several road and trail segments identified as being within riparian areas. These segments are associated with Sites 40, 41, 42, & 43, Sites 76 & 77, and the legacy road south of Site 80.

The trail associated with Sites 40 – 43 is not used and has become vegetated. No active erosion or sediment discharge was observed on the trail. The existing waterbars, outslope, and non-use of the trail is adequate to prevent sediment discharge. However, maintenance of the waterbars is being prescribed to maintain their functionality.

The seasonal road associated with Sites 76; 77, & 78 is not regularly used. Erosion and sediment discharge were observed on the seasonal road. The existing rolling dips, outslope, and seasonal use of the road is adequate to prevent sediment discharge. However, maintenance of the rolling dip at Site 76 and the application of rock surfacing of the road at Site 78 is being prescribed to prevent sediment discharge.

The legacy road associated with Site 80 is not used, has become vegetated, and has become blocked by downed trees. No erosion or sediment discharge was observed on the road. See the Mitigation Report, Treatment Implementation Schedule, and Site Map to follow for site specific details.

Table 4: Riparian and Wetland Protection and Management

Disturbed Area	Disturbance Area Distances and Riparian Setbacks ²				
	Class I [Setback: 100'] ²	Class II [Setback: 100']	Class III [Setback: 50']	Perennial Spring or Wetland [Setback: 50'] ²	Disturbed Area Within Setbacks [ft ²]
Cultivation Area A	>200'	>200'	>200'	>200'	0
Cultivation Area B	>200'	~170'	~120'	>200'	0
Cultivation Area C	>200'	~150'	>200'	>200'	0
Cultivation Area D	>200'	~100'	>200'	>200'	0
Cultivation Area E	>200'	~100'	>200'	>200'	8,032
				Total =	8,032

²This enrollment was previously enrolled in RWQCB Order No 2015-0023 and as such may retain reduced setbacks that were applicable under the previous Order.

Water Storage and Use:

Project Compliance Y /N

All water on the property is derived from a permitted well and two permitted surface water diversions located on the property. The well and surface water diversions meets and exceed the required water demands for both domestic and agricultural use. There are also two recreation and wildlife ponds on the property. None of the ponds are used for the irrigation of cannabis. At present there are no devices or procedures in place to record water usage on all of the Points of Diversion associated with the irrigation of cannabis, domestic use, and water used by the hydroelectric system. Water meters to monitor water usage shall be used to record all diverted and used water for the irrigation of cannabis, domestic use, and water used by the hydroelectric system. There is only one device that records water used for the irrigation of cannabis currently. Monthly water usage shall be recorded for annual reporting purposes.

Water is stored in three 1,550-gallon tanks, two 2,500-gallon tanks, one 3,000-gallon tank, two 5,000-gallon tanks, a ten-thousand-gallon tank, and a thirty-thousand-gallon cement tank. Fertilizer mixing occurs in several 305-gallon and 1,550-gallon tanks. There are also two existing wildlife/aesthetic ponds on the property of unknown volume. These ponds are not used to irrigate cannabis. There is also a proposed pond to be installed within the 3-acre conversion area on the property. If this pond is lined, it will require a wildlife fence of non-monofilament materials, around the entire perimeter of the pond. Tank lids shall be kept closed at all times when access is not needed. Tanks that do not utilize lids shall be retrofitted to be enclosed from wildlife. Overflow prevention measures be installed on diversion infrastructure or water storage tanks to prevent the overflowing of tanks and unnecessary diversion of water resources when water storage infrastructure has filled. Water conservation measures such as drip line irrigation and morning or evening watering is being used and shall continue to be implemented.

At this time, the cannabis cultivator has 62,650 gallons of water storage installed. Based on estimates, this volume of storage combined with the well’s output is sufficient to allow for full forbearance during the required period from April 1st to October 31st. Monthly water usage estimates and the season total are as follows below.

Table 5: Estimated Annual Water Use

	Jan	Feb	March	April (25%)	May (60%)	Jun (80%)	Jul (100%)	Aug (100%)	Sep (70%)	Oct (20%)	Nov	Dec
Agriculture				13,392	31,104	41,472	51,840	51,840	36,288	10,368		
Sq. ft. =								% = percent of peak usage				
17,280												
Total AG Water Use =											236,304	

There is domestic water use at this time, on this property. Water meter(s) and water supply infrastructure shall be designed/installed in a manner such that water usage for the irrigation of cannabis can be recorded separately from water used for domestic use. Additionally, if there are multiple diversions of surface water, infrastructure/metering device(s) shall be design/installed in a manner that each source of surface water is recorded separately.

A Lake and Streambed Alteration Agreement with the California Department of Fish and Wildlife, as well as an Initial Statement of Water Diversion and Use and a Small Irrigation and Use Registration with the California State Water Resource Control Board Division of Water Rights, has been finalized as of the writing of this assessment. Any additional guidelines, treatments, or restrictions set forth under the finalized Lake and Stream Agreement shall be followed.

Irrigation Runoff:

During visits to the property, no irrigation runoff, or evidence of such runoff, was observed at any of the cultivation areas.

Fertilizers, Pesticides, and Petroleum Products:

Project Compliance Y / N

Fertilizers, potting soils, compost, and other soils and soil amendments are currently stored in structures on the property in a manner in which they will not enter or be transported into surface waters and so that nutrients or other pollutants will not be leached into groundwater. Cultivation areas are currently maintained so as to prevent nutrients from leaving the site during the growing season and post-harvest.

Fertilizers and soil amendments are applied and used per the manufacturer’s guidelines. The use of pesticide products is consistent with product labeling and all products on the property are to be currently stored in closed structures to ensure that they do not enter or are released into surface or ground waters.

Currently, bulk fuel storage and petroleum products are present on the property. All bulk fuel storage tanks that are in-use have secondary containment and cover from precipitation. Three fuel storage tanks located at Site 86 have secondary containment and no cover from precipitation, but are not

currently used. All large portable generators, while they are in-use, have secondary containment and cover from precipitation, if they are used during the wet season.

Small quantities of fuel and motor oil are stored within fuel canisters, or the original motor oil container, in sheds nearby both of the residences without secondary containment and in vehicles. Any/all fuel canisters and motor oil containers shall be stored in secondary containment (e.g. plastic totes or sealed metal boxes) while being stored long term or not in immediate use, wherever these materials are used anywhere on the property.

Any/all petroleum products and other liquid chemicals, including but not limited to diesel, biodiesel, gasoline, and oils shall be stored so as to prevent their spillage, discharge, or seepage into receiving waters. Storage tanks and containers shall be of suitable material and construction to be compatible with the substance(s) stored and conditions of storage such as pressure and temperature. Above ground storage tanks and containers shall be provided with a secondary means of containment for the entire capacity of the largest single container and sufficient cover shall be provided to prevent any/all precipitation from entering said secondary containment vessel. Cannabis cultivators shall ensure that diked areas are sufficiently impervious to contain discharged chemicals. Cannabis cultivators shall implement spill prevention, control, and countermeasures (SPCC) and have appropriate cleanup materials available onsite if the volume of a fuel container is greater than 1,320 gallons. Underground storage tanks 110 gallons and larger shall be registered with the appropriate County department and comply with state and local requirements for leak detection, spill overflow, corrosion protection, and insurance coverage. On site storage of petroleum products, or other fuels used for commercial activities may require registration as hazardous materials through the California Environmental Reporting System (CERS). Additionally, any waste oil generated from commercial activities (generators) is considered by the state hazardous waste and requires addition reporting. This cannabis cultivator is advised to contact local agencies to find out if such reporting is applicable to currently operations.

Cultivation-Related Wastes:

Project Compliance Y /N

No cultivation-related wastes, including, but not limited to, empty soil/soil amendment/fertilizer/pesticide bags and containers, empty plant pots or containers, dead or harvested plant waste, and spent growth medium, are stored at locations where they can enter or be blown into surface waters, or in a manner that could result in residues and pollutants within such materials to migrate or leach into surface water or groundwaters.

Monofilament (e.g. plastic trellis netting and fencing) was observed on the property during the assessment. All monofilament netting or fencing is banned for future use. All existing monofilament netting shall be collected, secured with other refuse, and disposed of properly a waste disposal facility.

Organic cultivation-related wastes are collected from the cultivation areas and either disposed of properly with general waste, or composted or burned. The cannabis cultivator shall ensure that the

locations where organic wastes are stored, composted, or burned are minimized in number and are sited outside of watercourse riparian areas and away from any form of surface runoff.

Non-organic cultivation-related wastes are stored in lidded trashcans and garbage bags adjacent to or in the residence, sheds, and cultivation areas and are disposed of regularly at a solid waste transfer station. The cannabis cultivator shall continue to gather and properly dispose of cultivation-related wastes and ensure that wastes are adequately contained from scavenging wildlife, and cannot be transported away from storage areas by wind or surface runoff.

Refuse and Domestic Waste:

Project Compliance Y /N

Garbage and refuse are stored on the property within lidded trash cans and garbage bags and are disposed of regularly at the nearest solid waste transfer station. The cannabis cultivator shall continue to gather and properly dispose of refuse and ensure that refuse is adequately contained from scavenging wildlife, and cannot be transported away from storage areas by wind or surface runoff.

Human waste is managed by a septic system on site attached to the residence and several portable chemical toilets. It is the cannabis cultivator's responsibility to ensure compliance of such action with the Humboldt County Department of Environmental Health and Human Services.

Annual Winterization Measures

Winterization measures consist of general cleanup and winter-preparation activities that both prepare for, and utilize, anticipated, local winter weather.

- Any exposed soils resulting from winterization activities shall be seeded and straw mulched.
- Any/all areas of exposed soils in and around cultivation areas shall be seeded and straw mulched.
- All existing culvert inlets, interiors, and outlets shall be cleared of any existing or potential obstructions to include; debris upstream of the culvert such as sediment, loose, moveable rocks, and raftable, small, woody debris.
- Damage or wear resulting from vehicular use to road surfaces (such as rutting or wheel tracks) and/or road surfacing (such as rock) that would impair road surface drainage or drainage features (such as outsloping, waterbars, rolling dips, etc.) shall be repaired prior to the Winter Period.
- All existing surface drainage features and sediment capture features shall be maintained if needed to ensure continued function through the Winter Period.
- All fertilizers and petroleum products will be stored in an area located outside of riparian setbacks, completely sealed, placed in a secondary containment (liquids), and stored in a manner that prevents contact with precipitation and surface runoff.
- Chemical toilets will be removed from the property until need resumes the following cultivation season, or at a minimum serviced and left unused during periods when not in use.
- Water storage tank lids shall be appropriately closed to prevent the access of wildlife.
- All refuse/trash shall be removed and disposed of appropriately.
- All inorganic material capable of being transported by wind or rain shall be secured and stored appropriately.

STATEMENT OF CONTINGENT AND LIMITING CONDITIONS CONCERNING THE PREPARATION AND USE OF REPORTS ADDRESSING GENERAL WASTE DISCHARGE REQUIREMENTS UNDER ORDER WQ 2017-0023-DWQ

Prepared by Timberland Resource Consultants

1. This document has been prepared for the property within APN 221-240-015-000, 221-240-014-000, in Humboldt County, for enrollment in the General Waste Discharge Order WQ 2017-0023-DWQ.
2. Timberland Resource Consultants does not assume any liability for the use or misuse of the information in this document.
3. The information is based upon conditions apparent to Timberland Resource Consultants at the time inspection(s) were conducted. Changes due to land use activities or environmental factors occurring after inspection, have not been considered in this document.
4. Maps, photos, and any other graphical information presented in this report are for illustrative purposes. Their scales are approximate, and they are not to be used for locating and establishing boundary lines.
5. The conditions presented in this document may differ from those made by others or from changes on the property occurring after inspections were conducted. Timberland Resource Consultants does not guarantee this work against such differences.
6. Timberland Resource Consultants did not conduct an investigation on a legal survey of the property.
7. Persons using this document are advised to contact Timberland Resource Consultants prior to such use.
8. Timberland Resource Consultants will not discuss this document or reproduce it for anyone other than the Client for which this document was prepared without authorization from the Client.





Forrest Hansen

Timberland Resource Consultants

Site Management Plan

Site Map [WDID - 1_12CC405506]

- | | | | |
|--|-------------------|---|---------------------------------------|
|  | Property Boundary |  | Pond |
|  | Cultivation Areas |  | Unstable Area |
|  | Disturbed Area |  | Past Cultivation |
|  | Relocation Area |  | Cultivation Area within Riparian Area |
|  | Riparian Area |  | 3-acre Conversion Area |

- Roads**
-  Elk Ridge Road
 -  Road Segment in Riparian Setback
 -  Permanent
 -  Seasonal Access
 -  Trail
 -  Legacy

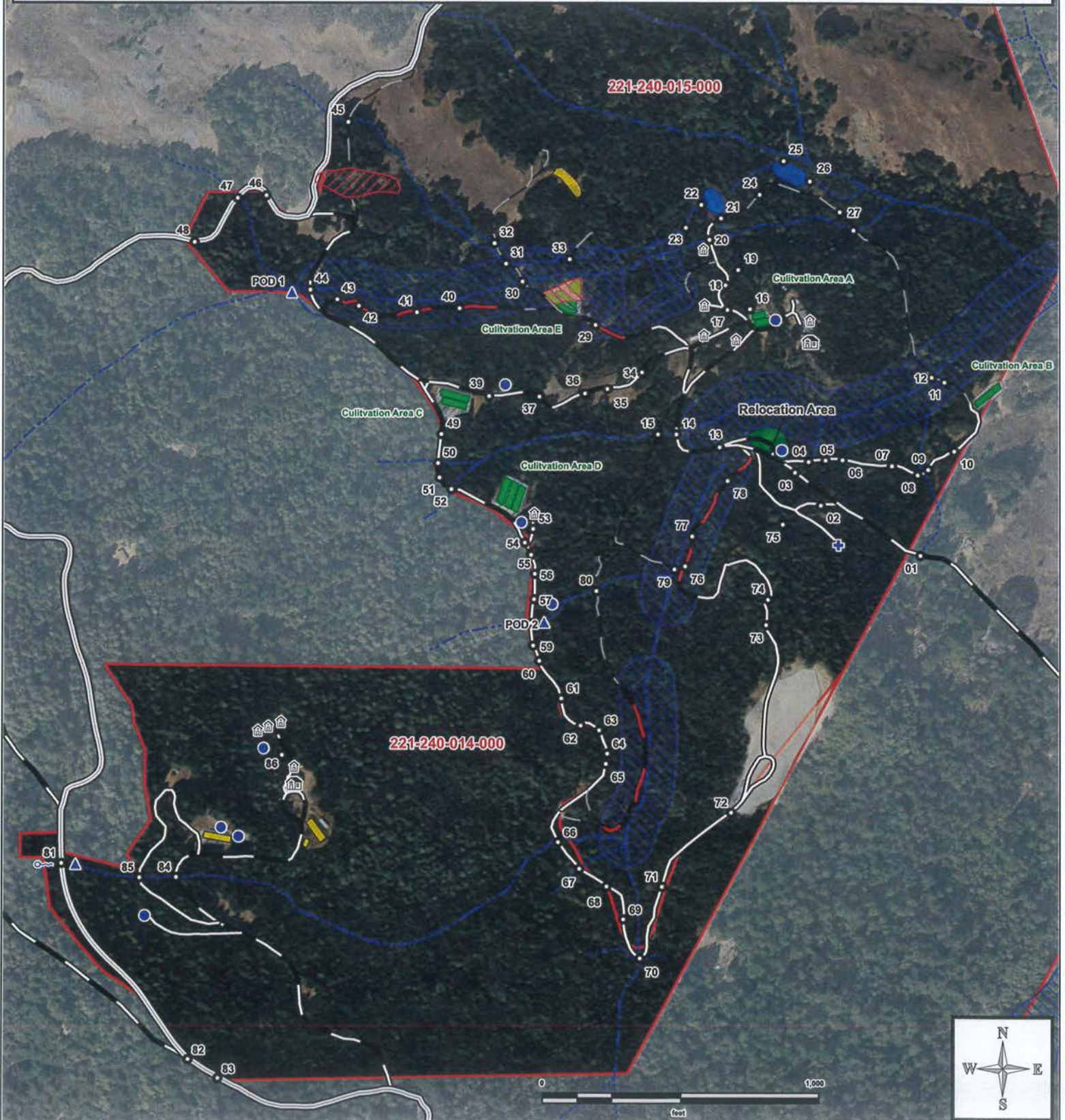
- Watercourses**
-  Class II
 -  Class III

-  Site
-  POD
-  Tank
-  Well
-  House
-  Structure
-  Spring



2018 NAIP DOQ
Map Date 4/23/2019

TRC - 113



Site Management Plan

Site Map [WDID - 1_12CC405506]



- | | |
|-------------------|---------------------------------------|
| Property Boundary | Pond |
| Cultivation Areas | Unstable Area |
| Disturbed Area | Past Cultivation |
| Relocation Area | Cultivation Area within Riparian Area |
| Riparian Area | 3-acre Conversion Area |

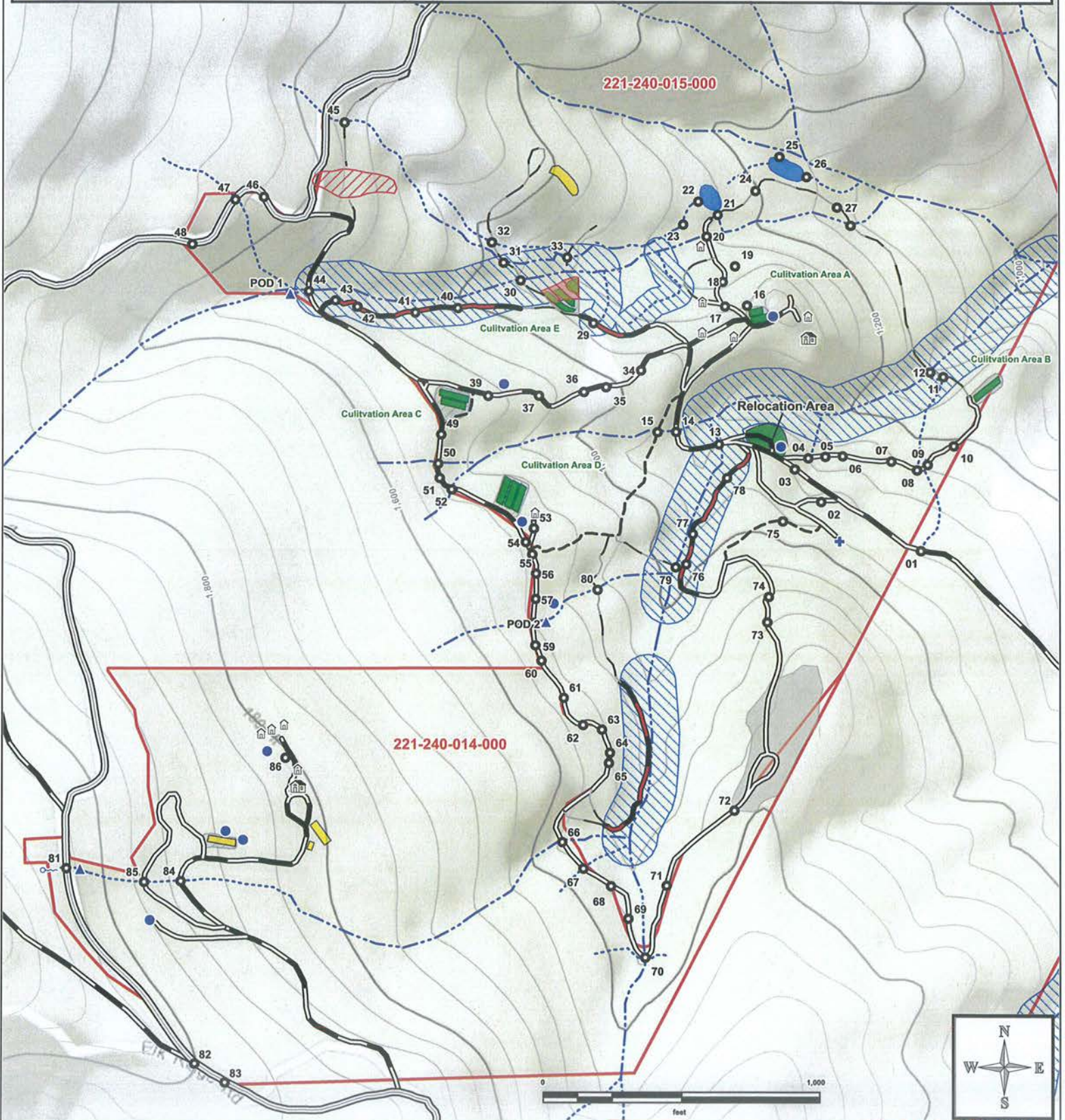
- Roads**
- Elk Ridge Road
 - Road Segment in Riparian Setback
 - Permanent Seasonal Access
 - Trail
 - Legacy

- Watercourses**
- Class II
 - Class III

- Site POD
- Tank
- Well
- House
- Structure
- Spring

40' contour intervals
Map Date 4/23/2019

TRC - 113





Treatment Implementation Schedule

Unique Point	Proposed Work Completion Date
Immediately	
22	Immediately
23	Immediately
19	Immediately
86	Immediately
Past Cultivation Areas	Immediately
Water Storage and Use	Immediately
Liquid Petroleum Products	Immediately
Generators and Gas Powered	Immediately
Prior to 10/15/2019	
6	Prior to 10/15/19
7	Prior to 10/15/19
16	Prior to 10/15/19
17	Prior to 10/15/19
18	Prior to 10/15/19
42	Prior to 10/15/19
43	Prior to 10/15/19
53	Prior to 10/15/19
55	Prior to 10/15/19
73	Prior to 10/15/19
74	Prior to 10/15/19
76	Prior to 10/15/19
78	Prior to 10/15/19
Prior to 10/15/2020	
2	Prior to 10/15/20
3	Prior to 10/15/20
46	Prior to 10/15/20
47	Prior to 10/15/20 pending the approval of any required permits

Prior to 10/15/2021	
1	Prior to 10/15/21
10	Prior to 10/15/21
11	Prior to 10/15/21 pending the approval of any required permits
12	Prior to 10/15/21 pending the approval of any required permits
13	Prior to 10/15/21
14	Prior to 10/15/21
15	Prior to 10/15/21
20	Prior to 10/15/21
21	Prior to 10/15/21
24	Prior to 10/15/21
27	Prior to 10/15/21
28	Prior to 10/15/21 pending the approval of any required permits
29	Prior to 10/15/21
30	Prior to 10/15/21
31	Prior to 10/15/21
32	Prior to 10/15/21
33	Prior to 10/15/21 pending the approval of any required permits
44	Prior to 10/15/21 pending the approval of any required permits
45	Prior to 10/15/21 pending the approval of any required permits
67	Prior to 10/15/21
79	Prior to 10/15/21
80	Prior to 10/15/21
81	Prior to 10/15/21 pending the approval of any required permits
84	Prior to 10/15/21 pending the approval of any required permits
85	Prior to 10/15/21 pending the approval of any required permits

As required	
Cultivation Area E	As required
4	As required
5	As required
8	As required
9	As required
25	As required
26	As required
34	As required
35	As required
36	As required
37	As required
39	As required
40	As required
41	As required
48	As required
49	As required
50	As required
51	As required
52	As required
54	As required
56	As required
57	As required
58	As required
59	As required
60	As required
61	As required
62	As required
63	As required
64	As required
65	As required
66	As required
68	As required
69	As required
70	As required
71	As required
72	As required
75	As required
77	As required
82	As required
83	As required



SMP - Mitigation Report

WDID# - 1_12CC405506

Unique Point	Lat-Long NAD 83	Road Type	Mitigation Planned	Monitor	1600	Treatment Priority	Date Completed
1	-123.897437 40.145548	Permanent	X	X	-	Prior to 10/15/21	
<p>Current Condition: Ditch relief culvert consisting of a 7" diameter corrugated aluminum pipe. The culvert is undersized and crushed at the inlet.</p>						<p>Prescribed Action: Replace the existing culvert with an 18" diameter ditch relief culvert per the specifications outlined in the attached BMPs: See Ditch Relief Culvert, and Permanent Culvert Crossing Design (Inlet and Outlet Armoring), General Operations BMPs, and General Erosion Control specifications.</p>	
Unique Point	Lat-Long NAD 83	Road Type	Mitigation Planned	Monitor	1600	Treatment Priority	Date Completed
2	-123.898735 40.146031	Seasonal	X	X	-	Prior to 10/15/20	
<p>Current Condition: Failing waterbar and a cutbank seep drainage relief culvert consisting of a 5" diameter corrugated plastic pipe.</p>						<p>Prescribed Action: Remove the culvert and waterbar and install a Type 1 rolling dip to drain the seep's flows across the road per the specifications outlined in the attached BMPs: See Rolling Dip Design and Placement, Rocked Rolling Dip Design and Placement, General Operations BMPs, and General Erosion Control specifications.</p>	
Unique Point	Lat-Long NAD 83	Road Type	Mitigation Planned	Monitor	1600	Treatment Priority	Date Completed
3	-123.899079 40.146356	Permanent	X	X	-	Prior to 10/15/20	
<p>Current Condition: Ditch relief culvert consisting of a 12" diameter corrugated aluminum pipe. The culvert is undersized, crushed at the inlet, too short in the fill, and eroding the fill prism at the outlet. There is also log rounds in the outlet channel that is, or will, cause more erosion and are obstructions.</p>						<p>Prescribed Action: Remove the log rounds from the outlet channel. Replace the existing culvert with an 18" diameter ditch relief culvert per the specifications outlined in the attached BMPs: See Ditch Relief Culvert, and Permanent Culvert Crossing Design (Inlet and Outlet Armoring), General Operations BMPs, and General Erosion Control specifications.</p>	
Unique Point	Lat-Long NAD 83	Road Type	Mitigation Planned	Monitor	1600	Treatment Priority	Date Completed
4	-123.898902 40.146465	Seasonal	-	X	-	As required	
<p>Current Condition: Functioning rocked rolling dip that is conveying flows from the ditch relief culvert at Site 03.</p>						<p>Prescribed Action: Maintain the rolling dip to the specifications outlined in the attached BMPs. See attached BMPs: See Rocked/Rolling Dip Design and Placement, General Operations BMPs, and General Erosion Control specifications.</p>	
Unique Point	Lat-Long NAD 83	Road Type	Mitigation Planned	Monitor	1600	Treatment Priority	Date Completed
5	-123.898681 40.146481	Seasonal	-	X	-	As required	
<p>Current Condition: Functioning rocked rolling dip.</p>						<p>Prescribed Action: Maintain the rolling dip to the specifications outlined in the attached BMPs. See attached BMPs: See Rocked/Rolling Dip Design and Placement, General Operations BMPs, and General Erosion Control specifications.</p>	



SMP - Mitigation Report

WDID# - 1_12CC405506

Unique Point	Lat-Long NAD 83	Road Type	Mitigation Planned	Monitor	1600	Treatment Priority	Date Completed
6	-123.898457 40.146488	Seasonal	X	X	-	Prior to 10/15/19	
Current Condition: Rocked rolling dip that is being bypassed by road surface runoff.						Prescribed Action: Maintenance the rocked rolling dip per the specifications outlined in the attached BMPs. See attached BMPs: See Rocked/Rolling Dip Design and Placement, General Operations BMPs, and General Erosion Control specifications.	
Unique Point	Lat-Long NAD 83	Road Type	Mitigation Planned	Monitor	1600	Treatment Priority	Date Completed
7	-123.897821 40.146439	Seasonal	X	X	-	Prior to 10/15/19	
Current Condition: Rocked rolling dip that is being bypassed by road surface runoff and cutbank seep flows. Minor rutting is also occurring on the rolling dip due to the lack of adequate rock surfacing.						Prescribed Action: Apply more rock surfacing to the rocked rolling dip and maintenance the rocked rolling dip per the specifications outlined in the attached BMPs. See attached BMPs: See Rocked/Rolling Dip Design and Placement, General Operations BMPs, and General Erosion Control specifications.	
Unique Point	Lat-Long NAD 83	Road Type	Mitigation Planned	Monitor	1600	Treatment Priority	Date Completed
8	-123.897485 40.146352	Seasonal	-	X	-	As required	
Current Condition: Ditch relief culvert consisting of an 24" diameter corrugated plastic pipe that is functioning adequately.						Prescribed Action: None. Maintain and monitor for plugging.	
Unique Point	Lat-Long NAD 83	Road Type	Mitigation Planned	Monitor	1600	Treatment Priority	Date Completed
9	-123.89735 40.146407	Seasonal	X	X	X	As required	
Current Condition: Class III watercourse crossing consisting of a rocked ford. The crossing is functioning adequately.						Prescribed Action: Apply rock surfacing as needed and maintain per the specifications outlined in the attached BMPs: See Rocked Ford and Armored Ford [Fill], General Operations BMPs, and General Erosion Control specifications.	
Unique Point	Lat-Long NAD 83	Road Type	Mitigation Planned	Monitor	1600	Treatment Priority	Date Completed
10	-123.897011 40.146595	Seasonal	X	X	-	Prior to 10/15/21	
Current Condition: Ditch relief culvert consisting of a 12" diameter corrugated metal pipe. The culvert is undersized, installed at a bad angle, rusted through, and eroding the fill prism at the outlet.						Prescribed Action: Replace the existing culvert with an 18" diameter ditch relief culvert per the specifications outlined in the attached BMPs: See Ditch Relief Culvert, and Permanent Culvert Crossing Design (Inlet and Outlet Armoring), General Operations BMPs, and General Erosion Control specifications.	



SMP - Mitigation Report

WDID# - 1_12CC405506

Unique Point	Lat-Long NAD 83	Road Type	Mitigation Planned	Monitor	1600	Treatment Priority	Date Completed
11	-123.897147 40.147283	Legacy	X	X	X	Prior to 10/15/21 pending the approval of any required permits	
<p>Current Condition: A Class III watercourse intercepts the inside ditch of a legacy road which is resulting in the erosion of the inside ditch and discharge into the inlet of the watercourse crossing at Site 12. There does not appear to be a historic channel to re-align the watercourse to and that the road was constructed along or on-top of the original watercourse channel.</p>						<p>Prescribed Action: In conjunction with the decommissioning of the watercourse crossing at Site 12, the road fill prism shall be pulled back and removed from along the current watercourse channel from this site to Site 12. The watercourse shall be fed into the watercourse at Site 12 approximately where the existing watercourse crossing at Site 12 is located. The road fill prism removal/decommissioning and alignment of the watercourse shall be abandoned to natural conditions as feasible. All road fill material shall be excavated from the channel and remaining side slopes laid back to a stable angle of 2:1 as feasible. The excavated channel shall have a consistent slope and width through the excavation matching the natural channel above and below the influence of the crossing fill. Exposed side slopes shall be planted with appropriate tree species and treated for erosion control measures. Erosion Control Measures shall include, but are not limited to, native grass seed, weed free straw, straw wattles, and jute netting. Excavated spoils material shall be stored on stable slopes, outside of any riparian area, where they cannot be transported away for the site by wind or rain, and treated for erosion control with seed and straw mulch and staked wattles around the spoils. See the attached BMPs: See Crossing Abandonment, General Operations BMPs, and General Erosion Control specifications.</p>	
Unique Point	Lat-Long NAD 83	Road Type	Mitigation Planned	Monitor	1600	Treatment Priority	Date Completed
12	-123.897315 40.14733	Legacy	X	X	X	Prior to 10/15/21 pending the approval of any required permits	
<p>Current Condition: Class II watercourse crossing consisting of a 48" diameter corrugated metal pipe that is undersized and has a Class III watercourse diverting into the inlet from Site 11.</p>						<p>Prescribed Action: Crossing shall be abandoned to natural conditions as feasible. All road fill material shall be excavated from the channel and remaining side slopes laid back to a stable angle of 2:1 as feasible. The excavated channel shall have a consistent slope and width through the excavation matching the natural channel above and below the influence of the crossing fill. Exposed side slopes shall be planted with appropriate tree species and treated for erosion control measures. Erosion Control Measures shall include, but are not limited to, native grass seed, weed free straw, straw wattles, and jute netting. Excavated spoils material shall be stored on stable slopes, outside of any riparian area, where they cannot be transported away for the site by wind or rain, and treated for erosion control with seed and straw mulch and staked wattles around the spoils. See the attached BMPs: See Crossing Abandonment, General Operations BMPs, and General Erosion Control specifications.</p>	



SMP - Mitigation Report

WDID# - 1_12CC405506

Unique Point	Lat-Long NAD 83	Road Type	Mitigation Planned	Monitor	1600	Treatment Priority	Date Completed
13	-123.900068 40.146603	Permanent	X	X	X	Prior to 10/15/21	
Current Condition: Class II watercourse crossing consisting of a 48" diameter corrugated metal pipe that is undersized.						Prescribed Action: Replace the existing culvert with an 84" diameter culvert per the specifications outlined in the attached BMPs: See Permanent Culvert Crossing, Permanent Culvert Crossing Design: Critical Dip and Hydrologic Disconnect Placement, Critical Dip, Culvert Orientation, Inlet and Outlet Armoring, General Operations BMPs, and General Erosion Control specifications.	
Unique Point	Lat-Long NAD 83	Road Type	Mitigation Planned	Monitor	1600	Treatment Priority	Date Completed
14	-123.900631 40.146727	Permanent	X	X	X	Prior to 10/15/21	
Current Condition: Class II watercourse crossing consisting of a 24" diameter corrugated metal pipe that is undersized and too short in the fill.						Prescribed Action: Replace the existing culvert with a 54" diameter culvert per the specifications outlined in the attached BMPs: See Permanent Culvert Crossing, Permanent Culvert Crossing Design: Critical Dip and Hydrologic Disconnect Placement, Critical Dip, Culvert Orientation, Inlet and Outlet Armoring, General Operations BMPs, and General Erosion Control specifications.	
Unique Point	Lat-Long NAD 83	Road Type	Mitigation Planned	Monitor	1600	Treatment Priority	Date Completed
15	-123.900874 40.146724	Trail	X	X	X	Prior to 10/15/21	
Current Condition: Class II watercourse crossing consisting of a 36" diameter corrugated metal pipe that is undersized.						Prescribed Action: Replace the existing culvert with an 54" diameter culvert per the specifications outlined in the attached BMPs: See Permanent Culvert Crossing, Permanent Culvert Crossing Design: Critical Dip and Hydrologic Disconnect Placement, Critical Dip, Culvert Orientation, Inlet and Outlet Armoring, General Operations BMPs, and General Erosion Control specifications.	
Unique Point	Lat-Long NAD 83	Road Type	Mitigation Planned	Monitor	1600	Treatment Priority	Date Completed
16	-123.899695 40.147985	-	X	X	-	Prior to 10/15/19	
Current Condition: Discarded soil and organic cultivation-related wastes along fillslope.						Prescribed Action: Seed and mulch with grass seed and weed free straw.	
Unique Point	Lat-Long NAD 83	Road Type	Mitigation Planned	Monitor	1600	Treatment Priority	Date Completed
17	-123.899987 40.147977	Seasonal	X	X	-	Prior to 10/15/19	
Current Condition: Kickout drainage feature that requires maintenance.						Prescribed Action: Maintenance per the specifications outlined in the attached BMPs. See attached BMPs: Steep Road Drainage and Waterbar Construction specifications.	



SMP - Mitigation Report

WDID# - 1_12CC405506

Unique Point	Lat-Long NAD 83	Road Type	Mitigation Planned	Monitor	1600	Treatment Priority	Date Completed
18	-123.900015 40.148223	Seasonal	X	X	-	Prior to 10/15/19	
<p>Current Condition: Concentrated road surface runoff is eroding the road surface and discharging into the outlet of the watercourse crossing at Site 20.</p>						<p>Prescribed Action: Install a waterbar per the specifications outlined in the attached BMPs: Waterbar Construction, General Operations BMPs, and General Erosion Control specifications. Maintain as needed.</p>	
Unique Point	Lat-Long NAD 83	Road Type	Mitigation Planned	Monitor	1600	Treatment Priority	Date Completed
19	-123.899852 40.148377	-	X	X	-	Immediately	
<p>Current Condition: Several 55-gallon drums used to hold new motor oil.</p>						<p>Prescribed Action: Store the 55-gallon drums in secondary containment equal to one of the drums total volume or remove them from the property.</p>	
Unique Point	Lat-Long NAD 83	Road Type	Mitigation Planned	Monitor	1600	Treatment Priority	Date Completed
20	-123.900229 40.148673	Seasonal	X	X	X	Prior to 10/15/21	
<p>Current Condition: Class II watercourse crossing of a 36" diameter corrugated metal pipe that is undersized, rusted through, too short, not-to-grade, and misaligned.</p>						<p>Prescribed Action: Replace the existing culvert with an 72" diameter culvert per the specifications outlined in the attached BMPs: See Permanent Culvert Crossing, Permanent Culvert Crossing Design: Critical Dip and Hydrologic Disconnect Placement, Critical Dip, Culvert Orientation, Inlet and Outlet Armoring, General Operations BMPs, and General Erosion Control specifications. Alternatively, the crossing can be abandoned to natural conditions as feasible. All road fill material shall be excavated from the channel and remaining side slopes laid back to a stable angle of 2:1 as feasible. The excavated channel shall have a consistent slope and width through the excavation matching the natural channel above and below the influence of the crossing fill. Exposed side slopes shall be planted with appropriate tree species and treated for erosion control measures. Erosion Control Measures shall include, but are not limited to, native grass seed, weed free straw, straw wattles, and jute netting. Excavated spoils material shall be stored on stable slopes, outside of any riparian area, where they cannot be transported away for the site by wind or rain, and treated for erosion control with seed and straw mulch and staked wattles around the spoils. See the attached BMPs: See Crossing Abandonment, General Operations BMPs, and General Erosion Control specifications.</p>	



SMP - Mitigation Report

WDID# - 1_12CC405506

Unique Point	Lat-Long NAD 83	Road Type	Mitigation Planned	Monitor	1600	Treatment Priority	Date Completed
21	-123.900082 40.148888	Legacy	X	X	X	Prior to 10/15/21	
<p>Current Condition: On-stream pond overflow consisting of a 24" diameter that is undersized, has a crushed inlet, and rusted through. This crossing does have a critical dip.</p>						<p>Prescribed Action: Replace the existing culvert with an 30" diameter culvert, or a 42" diameter culvert if the watercourses are re-aligned into historic channels at Sites 31 & 32. Alternatively, the cultivator can remove the existing culvert and install a rock armored spillway per the specifications outlined in the attached BMPs: See Rocked Ford, Armored Ford [Fill], Permanent Culvert Crossing, Permanent Culvert Crossing Design: Critical Dip and Hydrologic Disconnect Placement, Critical Dip, Culvert Orientation, Inlet and Outlet Armoring, General Operations BMPs, and General Erosion Control specifications.</p>	
Unique Point	Lat-Long NAD 83	Road Type	Mitigation Planned	Monitor	1600	Treatment Priority	Date Completed
22	-123.900337 40.149021	-	X	X	-	Immediately	
<p>Current Condition: Legacy refuse (tires) are located within the pond (Class II).</p>						<p>Prescribed Action: Remove the tires from the pond.</p>	
Unique Point	Lat-Long NAD 83	Road Type	Mitigation Planned	Monitor	1600	Treatment Priority	Date Completed
23	-123.900537 40.148792	-	X	X	X	Immediately	
<p>Current Condition: Legacy refuse (tires) have been discarded into the watercourse. The majority of tires have been removed with some still remaining in the watercourse.</p>						<p>Prescribed Action: Continue removing the tires from the watercourse.</p>	
Unique Point	Lat-Long NAD 83	Road Type	Mitigation Planned	Monitor	1600	Treatment Priority	Date Completed
24	-123.899581 40.149128	Legacy	X	X	-	Prior to 10/15/21	
<p>Current Condition: Concentrated road surface runoff an abandoned legacy road.</p>						<p>Prescribed Action: Install a waterbar per the specifications outlined in the attached BMPs: Waterbar Construction, General Operations BMPs, and General Erosion Control specifications. Maintain as needed.</p>	
Unique Point	Lat-Long NAD 83	Road Type	Mitigation Planned	Monitor	1600	Treatment Priority	Date Completed
25	-123.89927 40.149467	-	-	X	-	As required	
<p>Current Condition: On-stream pond emergency overflow consisting of a depression in the ponds fill prism.</p>						<p>Prescribed Action: None. Monitor.</p>	
Unique Point	Lat-Long NAD 83	Road Type	Mitigation Planned	Monitor	1600	Treatment Priority	Date Completed
26	-123.898921 40.149266	-	-	X	-	As required	
<p>Current Condition: On-stream pond overflow consisting of a 24" diameter that is functioning adequately.</p>						<p>Prescribed Action: None. Monitor.</p>	



SMP - Mitigation Report

WDID# - 1_12CC405506

Unique Point	Lat-Long NAD 83	Road Type	Mitigation Planned	Monitor	1600	Treatment Priority	Date Completed
27	-123.898525 40.148963	Legacy	X	X	-	Prior to 10/15/21	
<p>Current Condition: Concentrated road surface runoff an abandoned legacy road that is discharging into the inlet of the watercourse crossing at Site 28.</p>						<p>Prescribed Action: Install a waterbar per the specifications outlined in the attached BMPs: Waterbar Construction, General Operations BMPs, and General Erosion Control specifications. Maintain as needed.</p>	
Unique Point	Lat-Long NAD 83	Road Type	Mitigation Planned	Monitor	1600	Treatment Priority	Date Completed
28	-123.898347 40.148785	Legacy	X	X	X	Prior to 10/15/21 pending the approval of any required permits	
<p>Current Condition: Class II watercourse crossing consisting of a 48" diameter corrugated metal pipe that is undersized, decoupled in the fill, shot-gunned, and lacks rock armoring at the inlet.</p>						<p>Prescribed Action: Crossing shall be abandoned to natural conditions as feasible. All road fill material shall be excavated from the channel and remaining side slopes laid back to a stable angle of 2:1 as feasible. The excavated channel shall have a consistent slope and width through the excavation matching the natural channel above and below the influence of the crossing fill. Exposed side slopes shall be planted with appropriate tree species and treated for erosion control measures. Erosion Control Measures shall include, but are not limited to, native grass seed, weed free straw, straw wattles, and jute netting. Excavated spoils material shall be stored on stable slopes, outside of any riparian area, where they cannot be transported away for the site by wind or rain, and treated for erosion control with seed and straw mulch and staked wattles around the spoils. See the attached BMPs: See Crossing Abandonment, General Operations BMPs, and General Erosion Control specifications.</p>	
Unique Point	Lat-Long NAD 83	Road Type	Mitigation Planned	Monitor	1600	Treatment Priority	Date Completed
29	-123.901704 40.14781	Seasonal	X	X	-	Prior to 10/15/21	
<p>Current Condition: Ditch relief culvert consisting of a 12" diameter corrugated aluminum pipe that has a crushed inlet, too short in the fill, and down cutting through fill at the outlet. There is also refuse in the channel at the outlet.</p>						<p>Prescribed Action: Remove and properly dispose of the refuse. Replace the existing culvert with an 15" diameter ditch relief culvert or install a rocked rolling dip to drain the ditch per the specifications outlined in the attached BMPs: See Rocked/Rolling Dip Design and Placement, Ditch Relief Culvert, and Permanent Culvert Crossing Design (Inlet and Outlet Armoring), General Operations BMPs, and General Erosion Control specifications.</p>	



SMP - Mitigation Report

WDID# - 1_12CC405506

Unique Point	Lat-Long NAD 83	Road Type	Mitigation Planned	Monitor	1600	Treatment Priority	Date Completed
30	-123.90266 40.148235	Legacy	X	X	X	Prior to 10/15/21	
<p>Current Condition: Class II watercourse crossing consisting of a 48" diameter corrugated metal pipe that is rusted through, too short, shot-gunned, misaligned and intercepting two other diverted watercourses at the inlet.</p>						<p>Prescribed Action: Crossing shall be abandoned to natural conditions as feasible. All road fill material shall be excavated from the channel and remaining side slopes laid back to a stable angle of 2:1 as feasible. The excavated channel shall have a consistent slope and width through the excavation matching the natural channel above and below the influence of the crossing fill. Exposed side slopes shall be planted with appropriate tree species and treated for erosion control measures. Erosion Control Measures shall include, but are not limited to, native grass seed, weed free straw, straw wattles, and jute netting. Excavated spoils material shall be stored on stable slopes, outside of any riparian area, where they cannot be transported away for the site by wind or rain, and treated for erosion control with seed and straw mulch and staked wattles around the spoils. See the attached BMPs: See Crossing Abandonment, General Operations BMPs, and General Erosion Control specifications.</p>	
Unique Point	Lat-Long NAD 83	Road Type	Mitigation Planned	Monitor	1600	Treatment Priority	Date Completed
31	-123.902883 40.148412	Legacy	X	X	X	Prior to 10/15/21	
<p>Current Condition: A Class II watercourse is diverting down the inside ditch of a legacy road. The inside ditch is eroding and discharging into the inlet of the watercourse crossing at Site 30.</p>						<p>Prescribed Action: Re-alignment of this watercourse to its historic channel was proposed and agreed upon in LSA Agreement with CDFW (Notification #1600-2017-0296-R1). However, upon further assessment re-alignment of this watercourse will cause further complications downstream. Re-alignment of this watercourse will cause further complications such as re-activating erosion within the historic channel, which appears to be a historic channel migration that is incised, possibly causing a watercourse crossing failure at Site 33, and with the on-stream pond at Site 21. The current best course of action would be to leave the current watercourse alignment as is, lay back the caving road fill from along the current watercourse channel, and install a rock-lined channel into the to be decommissioned crossing at Site 30. Similar to what is proposed at Sites 11 & 12.</p>	



SMP - Mitigation Report

WDID# - 1_12CC405506

Unique Point	Lat-Long NAD 83	Road Type	Mitigation Planned	Monitor	1600	Treatment Priority	Date Completed
32	-123.903033 40.148613	Legacy	X	X	X	Prior to 10/15/21	
<p>Current Condition: A Class III watercourse is diverting down the inside ditch of a legacy road. The inside ditch is eroding and discharging into the inlet of the watercourse crossing at Site 30.</p>						<p>Prescribed Action: Re-alignment of this watercourse to its historic channel was proposed and agreed upon in LSA Agreement with CDFW (Notification #1600-2017-0296-R1). However, upon further assessment re-alignment of this watercourse will cause further complications downstream. Re-alignment of this watercourse will cause further complications such as re-activating erosion within the historic channel, which appears to be a historic channel migration that is incised, possibly causing a watercourse crossing failure at Site 33, and with the on-stream pond at Site 21. The current best course of action would be to leave the current watercourse alignment as is, install a defined, rock-lined, channel in the current watercourses flow path, and feed it into Site 31. Similar to what is proposed at Sites 11 & 12.</p>	
Unique Point	Lat-Long NAD 83	Road Type	Mitigation Planned	Monitor	1600	Treatment Priority	Date Completed
33	-123.902048 40.148463	Legacy	X	X	X	Prior to 10/15/21 pending the approval of any required permits	
<p>Current Condition: Class II watercourse crossing consisting of a 24" corrugated aluminum pipe on a legacy road that is no longer accessible.</p>						<p>Prescribed Action: Crossing shall be abandoned to natural conditions as feasible. All road fill material shall be excavated from the channel and remaining side slopes laid back to a stable angle of 2:1 as feasible. The excavated channel shall have a consistent slope and width through the excavation matching the natural channel above and below the influence of the crossing fill. Exposed side slopes shall be planted with appropriate tree species and treated for erosion control measures. Erosion Control Measures shall include, but are not limited to, native grass seed, weed free straw, straw wattles, and jute netting. Excavated spoils material shall be stored on stable slopes, outside of any riparian area, where they cannot be transported away for the site by wind or rain, and treated for erosion control with seed and straw mulch and staked wattles around the spoils. See the attached BMPs: See Crossing Abandonment, General Operations BMPs, and General Erosion Control specifications.</p>	
Unique Point	Lat-Long NAD 83	Road Type	Mitigation Planned	Monitor	1600	Treatment Priority	Date Completed
34	-123.901088 40.147341	Permanent	-	X	-	As required	
<p>Current Condition: Functioning kickout drainage features on either side of the road.</p>						<p>Prescribed Action: Maintain per the specifications outlined in the attached BMPs. See attached BMPs: Steep Road Drainage, Waterbar Construction, General Operations BMPs, and General Erosion Control specifications.</p>	



SMP - Mitigation Report

WDID# - 1_12CC405506

Unique Point	Lat-Long NAD 83	Road Type	Mitigation Planned	Monitor	1600	Treatment Priority	Date Completed
35	-123.901541 40.147173	Permanent	-	X	-	As required	
Current Condition: Functioning kickout drainage feature.						Prescribed Action: Maintain per the specifications outlined in the attached BMPs. See attached BMPs: Steep Road Drainage, Waterbar Construction, General Operations BMPs, and General Erosion Control specifications.	
Unique Point	Lat-Long NAD 83	Road Type	Mitigation Planned	Monitor	1600	Treatment Priority	Date Completed
36	-123.901829 40.147125	Permanent	-	X	-	As required	
Current Condition: Ditch crossing consisting of an 18" diameter corrugated plastic pipe and a functioning kickout drainage feature along the outboard edge of the road.						Prescribed Action: Maintain per the specifications outlined in the attached BMPs. See attached BMPs: Steep Road Drainage, Waterbar Construction, General Operations BMPs, and General Erosion Control specifications.	
Unique Point	Lat-Long NAD 83	Road Type	Mitigation Planned	Monitor	1600	Treatment Priority	Date Completed
37	-123.902422 40.147087	Permanent	-	X	-	As required	
Current Condition: Functioning kickout drainage feature.						Prescribed Action: Maintain per the specifications outlined in the attached BMPs. See attached BMPs: Steep Road Drainage, Waterbar Construction, General Operations BMPs, and General Erosion Control specifications.	
Unique Point	Lat-Long NAD 83	Road Type	Mitigation Planned	Monitor	1600	Treatment Priority	Date Completed
39	-123.903082 40.147086	Permanent	-	X	-	As required	
Current Condition: Functioning inside ditch leadout drainage feature.						Prescribed Action: Maintain per the specifications outlined in the attached BMPs. See attached BMPs: Steep Road Drainage, Waterbar Construction, General Operations BMPs, and General Erosion Control specifications.	
Unique Point	Lat-Long NAD 83	Road Type	Mitigation Planned	Monitor	1600	Treatment Priority	Date Completed
40	-123.903479 40.14796	Legacy	-	X	-	As required	
Current Condition: Cutbank seep drains across the legacy trail and has caused some erosion in the past on the trail up grade. However, there is no active erosion and the trail and past erosion has become well vegetated.						Prescribed Action: None. Monitor for active erosion occurring again. If erosion of the trails surface begins again, install a series of waterbars per the specifications outlined in the attached BMPs: See attached BMPs: Waterbar Construction, General Operations BMPs, and General Erosion Control specifications.	
Unique Point	Lat-Long NAD 83	Road Type	Mitigation Planned	Monitor	1600	Treatment Priority	Date Completed
41	-123.904033 40.147913	Legacy	-	X	-	As required	
Current Condition: Cutbank seep drains across the legacy trail via a natural dip in the trails surface into an area that has 1' to 2' fissure cracks. The area appears stable and is well vegetated.						Prescribed Action: None. Monitor.	



SMP - Mitigation Report

WDID# - 1_12CC405506

Unique Point	Lat-Long NAD 83	Road Type	Mitigation Planned	Monitor	1600	Treatment Priority	Date Completed
42	-123.904783 40.147972	Legacy	X	X	-	Prior to 10/15/19	
Current Condition: Waterbar requiring maintenance						Prescribed Action: Maintenance the waterbar per the specifications outlined in the attached BMPs: Waterbar Construction, General Operations BMPs, and General Erosion Control specifications. Maintain as needed.	
Unique Point	Lat-Long NAD 83	Road Type	Mitigation Planned	Monitor	1600	Treatment Priority	Date Completed
43	-123.905065 40.148035	Legacy	X	X	-	Prior to 10/15/19	
Current Condition: Waterbar requiring maintenance						Prescribed Action: Maintenance the waterbar per the specifications outlined in the attached BMPs: Waterbar Construction, General Operations BMPs, and General Erosion Control specifications. Maintain as needed.	
Unique Point	Lat-Long NAD 83	Road Type	Mitigation Planned	Monitor	1600	Treatment Priority	Date Completed
44	-123.905417 40.148128	Permanent	X	X	X	Prior to 10/15/21 pending the approval of any required permits	
Current Condition: Class II watercourse crossing consisting of a 36" diameter corrugated aluminum pipe that is installed correctly but undersized and lacks adequate rock armoring at the inlet.						Prescribed Action: Replace the existing culvert with an 72" diameter culvert per the specifications outlined in the attached BMPs: See Permanent Culvert Crossing, Permanent Culvert Crossing Design: Critical Dip and Hydrologic Disconnect Placement, Critical Dip, Culvert Orientation, Inlet and Outlet Armoring, General Operations BMPs, and General Erosion Control specifications.	
Unique Point	Lat-Long NAD 83	Road Type	Mitigation Planned	Monitor	1600	Treatment Priority	Date Completed
45	-123.904949 40.149806	Legacy	X	X	X	Prior to 10/15/21 pending the approval of any required permits	
Current Condition: Class II watercourse crossing consisting of a 24" diameter corrugated metal pipe that is sized and installed correctly but on a legacy road that is no longer used.						Prescribed Action: Crossing shall be abandoned to natural conditions as feasible. All road fill material shall be excavated from the channel and remaining side slopes laid back to a stable angle of 2:1 as feasible. The excavated channel shall have a consistent slope and width through the excavation matching the natural channel above and below the influence of the crossing fill. Exposed side slopes shall be planted with appropriate tree species and treated for erosion control measures. Erosion Control Measures shall include, but are not limited to, native grass seed, weed free straw, straw wattles, and jute netting. Excavated spoils material shall be stored on stable slopes, outside of any riparian area, where they cannot be transported away for the site by wind or rain, and treated for erosion control with seed and straw mulch and staked wattles around the spoils. See the attached BMPs: See Crossing Abandonment, General Operations BMPs, and General Erosion Control specifications.	



SMP - Mitigation Report

WDID# - 1_12CC405506

Unique Point	Lat-Long NAD 83	Road Type	Mitigation Planned	Monitor	1600	Treatment Priority	Date Completed
46	-123.906008 40.149065	Permanent	X	X	-	Prior to 10/15/20	
<p>Current Condition: Ditch relief culvert consisting of a 12" diameter corrugated aluminum pipe that has a crushed inlet, too short, installed at a bad angle, and is eroding the road fillslope at the outlet.</p>						<p>Prescribed Action: Replace the existing culvert with an 18" diameter ditch relief culvert per the specifications outlined in the attached BMPs: See Ditch Relief Culvert, and Permanent Culvert Crossing Design (Inlet and Outlet Armoring), General Operations BMPs, and General Erosion Control specifications.</p>	
Unique Point	Lat-Long NAD 83	Road Type	Mitigation Planned	Monitor	1600	Treatment Priority	Date Completed
47	-123.90638 40.149035	Permanent	X	X	X	Prior to 10/15/20 pending the approval of any required permits	
<p>Current Condition: Class III watercourse crossing consisting of a 18" diameter corrugated metal pipe that is undersized, has metal sheeting armoring at the outlet, too short in the fill, not-to-grade, has the potential to divert downgrade, and is eroding the fillslope at the outlet.</p>						<p>Prescribed Action: Replace the existing culvert with an 36" diameter culvert per the specifications outlined in the attached BMPs: See Permanent Culvert Crossing, Permanent Culvert Crossing Design: Critical Dip and Hydrologic Disconnect Placement, Critical Dip, Culvert Orientation, Inlet and Outlet Armoring, General Operations BMPs, and General Erosion Control specifications.</p>	
Unique Point	Lat-Long NAD 83	Road Type	Mitigation Planned	Monitor	1600	Treatment Priority	Date Completed
48	-123.906937 40.148592	Permanent	-	X	-	As required	
<p>Current Condition: Ditch relief culvert consisting of an 24" diameter corrugated metal pipe that is functioning adequately.</p>						<p>Prescribed Action: None. Maintain and monitor for plugging.</p>	
Unique Point	Lat-Long NAD 83	Road Type	Mitigation Planned	Monitor	1600	Treatment Priority	Date Completed
49	-123.903693 40.1467	Permanent	-	-	-	As required	
<p>Current Condition: Ditch relief consisting of a rocked rolling dip.</p>						<p>Prescribed Action: Maintain per the specifications outlined in the attached BMPs. See attached BMPs: Steep Road Drainage, Waterbar Construction, General Operations BMPs, and General Erosion Control specifications.</p>	
Unique Point	Lat-Long NAD 83	Road Type	Mitigation Planned	Monitor	1600	Treatment Priority	Date Completed
50	-123.903733 40.14641	Permanent	X	X	X	As required	
<p>Current Condition: Class II watercourse crossing consisting of a 24" diameter corrugated metal pipe that is installed correctly, has a critical dip, and sized adequately for the 100-year storm event peak flow, but not associated debris.</p>						<p>Prescribed Action: None. Monitor for plugging. Because the crossing is sized correctly for peak flow and has a critical dip replacing, this culvert with a larger culvert size is not being recommended.</p>	



SMP - Mitigation Report

WDID# - 1_12CC405506

Unique Point	Lat-Long NAD 83	Road Type	Mitigation Planned	Monitor	1600	Treatment Priority	Date Completed
51	-123.903711 40.146267	Permanent	-	X	X	As required	
<p>Current Condition: Class III watercourse intercepts the inside ditch between both adjacent watercourse crossings. The watercourse primary diverts into the inlet of the watercourse crossing at Site 50, with some flows diverting to the crossing at Site 52. No notable erosion of the inside ditch or road shoulder is occurring.</p>						<p>Prescribed Action: None. Monitor for erosion and the inside ditch filling with debris that could cause flow diversion out of the ditch. Rock armor the road shoulder and ditch if needed.</p>	
Unique Point	Lat-Long NAD 83	Road Type	Mitigation Planned	Monitor	1600	Treatment Priority	Date Completed
52	-123.903555 40.146153	Permanent	X	X	X	As required	
<p>Current Condition: Class II watercourse crossing consisting of a 24" diameter corrugated metal pipe that is installed correctly, has a critical dip, and sized adequately for the 100-year storm event peak flow, but not associated debris.</p>						<p>Prescribed Action: None. Monitor for plugging. Because the crossing is sized correctly for peak flow and has a critical dip replacing this culvert with a larger culvert size is not being recommended.</p>	
Unique Point	Lat-Long NAD 83	Road Type	Mitigation Planned	Monitor	1600	Treatment Priority	Date Completed
53	-123.902486 40.145766	Permanent	X	X	-	Prior to 10/15/19	
<p>Current Condition: Rutting on an unsurfaced access road to the shed. Seep flows from Site 55 and road surface runoff is draining into the ruts then concentrating on a mountain bike course downslope from this site, resulting in gullying and erosion of the course.</p>						<p>Prescribed Action: Apply rock surfacing to approximately 50' to 75' of the road surface where the rutting is occurring. Apply mitigations prescribed for Site 55 to prevent seep flows from contributing to the erosion and road saturation at this site.</p>	
Unique Point	Lat-Long NAD 83	Road Type	Mitigation Planned	Monitor	1600	Treatment Priority	Date Completed
54	-123.902592 40.145628	Permanent	-	X	-	As required	
<p>Current Condition: Ditch relief culvert consisting of a 12" diameter corrugated plastic pipe that is installed correctly and functioning adequately.</p>						<p>Prescribed Action: None. Maintain and monitor for plugging.</p>	
Unique Point	Lat-Long NAD 83	Road Type	Mitigation Planned	Monitor	1600	Treatment Priority	Date Completed
55	-123.902507 40.145507	Seasonal	X	X	-	Prior to 10/15/19	
<p>Current Condition: Cutbank seep that is not being captured by a rock lined rolling dip and rock lined ditch. Seep flows are draining downgrade and contributing to road saturation and erosion at Site 53.</p>						<p>Prescribed Action: Install a catchment basin at the inlet of the rock lined rolling dip, as flagged in the field, that will capture the seep flows and prevent their diversion down the road.</p>	
Unique Point	Lat-Long NAD 83	Road Type	Mitigation Planned	Monitor	1600	Treatment Priority	Date Completed
56	-123.902457 40.145316	Seasonal	-	X	-	As required	
<p>Current Condition: Functioning rock lined rolling dip.</p>						<p>Prescribed Action: Maintain the rolling dip to the specifications outlined in the attached BMPs. See attached BMPs: See Rocked/Rolling Dip Design and Placement, General Operations BMPs, and General Erosion Control specifications.</p>	



SMP - Mitigation Report

WDID# - 1_12CC405506

Unique Point	Lat-Long NAD 83	Road Type	Mitigation Planned	Monitor	1600	Treatment Priority	Date Completed
57	-123.902465 40.1445063	Seasonal	-	X	-	As required	
Current Condition: Functioning rocked rolling dip.						Prescribed Action: Maintain the rolling dip to the specifications outlined in the attached BMPs. See attached BMPs: See Rocked/Rolling Dip Design and Placement, General Operations BMPs, and General Erosion Control specifications.	
Unique Point	Lat-Long NAD 83	Road Type	Mitigation Planned	Monitor	1600	Treatment Priority	Date Completed
58	-123.902497 40.144826	Seasonal	-	X	X	As required	
Current Condition: Class II watercourse crossing consisting of a 24" diameter corrugated metal pipe that is installed correctly, has a critical dip, but is undersized for the 100-year storm event. Based on in-stream channel measurements, the current culvert is adequately sized for the 100-year storm event.						Prescribed Action: None. Monitor for plugging. Because in-stream channel measurements show that the current culvert is adequately sized for the 100-year storm event, the culvert is correctly installed with rock armoring, and has an critical dip, replacing this culvert with a larger culvert size is not being recommended.	
Unique Point	Lat-Long NAD 83	Road Type	Mitigation Planned	Monitor	1600	Treatment Priority	Date Completed
59	-123.902466 40.144602	Seasonal	-	X	-	As required	
Current Condition: Functioning rocked rolling dip.						Prescribed Action: Maintain the rolling dip to the specifications outlined in the attached BMPs. See attached BMPs: See Rocked/Rolling Dip Design and Placement, General Operations BMPs, and General Erosion Control specifications.	
Unique Point	Lat-Long NAD 83	Road Type	Mitigation Planned	Monitor	1600	Treatment Priority	Date Completed
60	-123.902386 40.14445	Seasonal	-	X	-	As required	
Current Condition: Functioning rocked rolling dip.						Prescribed Action: Maintain the rolling dip to the specifications outlined in the attached BMPs. See attached BMPs: See Rocked/Rolling Dip Design and Placement, General Operations BMPs, and General Erosion Control specifications.	
Unique Point	Lat-Long NAD 83	Road Type	Mitigation Planned	Monitor	1600	Treatment Priority	Date Completed
61	-123.902093 40.14408	Seasonal	-	X	-	As required	
Current Condition: Functioning rocked rolling dip.						Prescribed Action: Maintain the rolling dip to the specifications outlined in the attached BMPs. See attached BMPs: See Rocked/Rolling Dip Design and Placement, General Operations BMPs, and General Erosion Control specifications.	



SMP - Mitigation Report

WDID# - 1_12CC405506

Unique Point	Lat-Long NAD 83	Road Type	Mitigation Planned	Monitor	1600	Treatment Priority	Date Completed
62	-123.90184 40.143812	Seasonal	-	X	-	As required	
Current Condition: Functioning rocked rolling dip.						Prescribed Action: Maintain the rolling dip to the specifications outlined in the attached BMPs. See attached BMPs: See Rocked/Rolling Dip Design and Placement, General Operations BMPs, and General Erosion Control specifications.	
Unique Point	Lat-Long NAD 83	Road Type	Mitigation Planned	Monitor	1600	Treatment Priority	Date Completed
63	-123.901597 40.143765	Seasonal	-	X	-	As required	
Current Condition: Functioning rocked rolling dip.						Prescribed Action: Maintain the rolling dip to the specifications outlined in the attached BMPs. See attached BMPs: See Rocked/Rolling Dip Design and Placement, General Operations BMPs, and General Erosion Control specifications.	
Unique Point	Lat-Long NAD 83	Road Type	Mitigation Planned	Monitor	1600	Treatment Priority	Date Completed
64	-123.901491 40.143534	Seasonal	-	X	-	As required	
Current Condition: Functioning rocked rolling dip.						Prescribed Action: Maintain the rolling dip to the specifications outlined in the attached BMPs. See attached BMPs: See Rocked/Rolling Dip Design and Placement, General Operations BMPs, and General Erosion Control specifications.	
Unique Point	Lat-Long NAD 83	Road Type	Mitigation Planned	Monitor	1600	Treatment Priority	Date Completed
65	-123.901505 40.143432	Seasonal	-	X	-	As required	
Current Condition: Functioning rocked rolling dip.						Prescribed Action: Maintain the rolling dip to the specifications outlined in the attached BMPs. See attached BMPs: See Rocked/Rolling Dip Design and Placement, General Operations BMPs, and General Erosion Control specifications.	
Unique Point	Lat-Long NAD 83	Road Type	Mitigation Planned	Monitor	1600	Treatment Priority	Date Completed
66	-123.902202 40.142779	Seasonal	-	X	X	As required	
Current Condition: Class II watercourse crossing consisting of a 48" diameter corrugated plastic pipe that is installed correctly, sized adequately for the 100-year storm event, and doesn't have a critical dip but does not have the potential for diversion.						Prescribed Action: None. Maintain and monitor for plugging.	



SMP - Mitigation Report

WDID# - 1_12CC405506

Unique Point	Lat-Long NAD 83	Road Type	Mitigation Planned	Monitor	1600	Treatment Priority	Date Completed
67	-123.901836 40.142385	Seasonal	X	X	X	Prior to 10/15/21	
<p>Current Condition: Class III watercourse crossing consisting of a 10" diameter corrugated plastic pipe that is undersized, has a crushed inlet, not-to-grade, and installed on top of a Humboldt ford. The watercourse at the inlet goes subsurface and only a small amount of flows reach the culvert inlet.</p>						<p>Prescribed Action: Replace the existing culvert with an 24" diameter culvert per the specifications outlined in the attached BMPs: See Permanent Culvert Crossing, Permanent Culvert Crossing Design: Critical Dip and Hydrologic Disconnect Placement, Critical Dip, Culvert Orientation, Inlet and Outlet Armoring, General Operations BMPs, and General Erosion Control specifications.</p>	
Unique Point	Lat-Long NAD 83	Road Type	Mitigation Planned	Monitor	1600	Treatment Priority	Date Completed
68	-123.901478 40.142211	Seasonal	-	X	-	As required	
<p>Current Condition: Functioning rocked rolling dip.</p>						<p>Prescribed Action: Maintain the rolling dip to the specifications outlined in the attached BMPs. See attached BMPs: See Rocked/Rolling Dip Design and Placement, General Operations BMPs, and General Erosion Control specifications.</p>	
Unique Point	Lat-Long NAD 83	Road Type	Mitigation Planned	Monitor	1600	Treatment Priority	Date Completed
69	-123.901253 40.141886	Seasonal	-	X	-	As required	
<p>Current Condition: Functioning rocked rolling dip.</p>						<p>Prescribed Action: Maintain the rolling dip to the specifications outlined in the attached BMPs. See attached BMPs: See Rocked/Rolling Dip Design and Placement, General Operations BMPs, and General Erosion Control specifications.</p>	
Unique Point	Lat-Long NAD 83	Road Type	Mitigation Planned	Monitor	1600	Treatment Priority	Date Completed
70	-123.901032 40.141501	Seasonal	-	X	X	As required	
<p>Current Condition: Class II watercourse crossing consisting of a 48" diameter corrugated plastic pipe that is installed correctly, sized adequately for the 100-year storm event, and has a critical dip.</p>						<p>Prescribed Action: None. Maintain and monitor for plugging.</p>	
Unique Point	Lat-Long NAD 83	Road Type	Mitigation Planned	Monitor	1600	Treatment Priority	Date Completed
71	-123.900756 40.142215	Seasonal	-	X	-	As required	
<p>Current Condition: Functioning rocked rolling dip that drains the inside ditch.</p>						<p>Prescribed Action: Maintain the rolling dip to the specifications outlined in the attached BMPs. See attached BMPs: See Rocked/Rolling Dip Design and Placement, General Operations BMPs, and General Erosion Control specifications.</p>	



SMP - Mitigation Report

WDID# - 1_12CC405506

Unique Point	Lat-Long NAD 83	Road Type	Mitigation Planned	Monitor	1600	Treatment Priority	Date Completed
72	-123.899868 40.142962	Seasonal	-	X	-	As required	
Current Condition: Ditch relief culvert consisting of an 18" diameter corrugated plastic pipe that is installed correctly and functioning adequately.						Prescribed Action: None. Maintain.	
Unique Point	Lat-Long NAD 83	Road Type	Mitigation Planned	Monitor	1600	Treatment Priority	Date Completed
73	-123.899435 40.144833	Seasonal	X	X	-	Prior to 10/15/19	
Current Condition: Concentrated road surface runoff is eroding the road surface.						Prescribed Action: Install a waterbar per the specifications outlined in the attached BMPs: Waterbar Construction, General Operations BMPs, and General Erosion Control specifications. Maintain as needed.	
Unique Point	Lat-Long NAD 83	Road Type	Mitigation Planned	Monitor	1600	Treatment Priority	Date Completed
74	-123.899415 40.145085	Seasonal	X	X	-	Prior to 10/15/19	
Current Condition: Concentrated road surface runoff is eroding the road surface.						Prescribed Action: Install a waterbar per the specifications outlined in the attached BMPs: Waterbar Construction, General Operations BMPs, and General Erosion Control specifications. Maintain as needed.	
Unique Point	Lat-Long NAD 83	Road Type	Mitigation Planned	Monitor	1600	Treatment Priority	Date Completed
75	-123.899233 40.145837	Seasonal	-	X	-	As required	
Current Condition: Functioning rocked rolling dip.						Prescribed Action: Maintain the rolling dip to the specifications outlined in the attached BMPs. See attached BMPs: See Rocked/Rolling Dip Design and Placement, General Operations BMPs, and General Erosion Control specifications.	
Unique Point	Lat-Long NAD 83	Road Type	Mitigation Planned	Monitor	1600	Treatment Priority	Date Completed
76	-123.900501 40.14541	Seasonal	X	X	-	Prior to 10/15/19	
Current Condition: Rolling dip that is being bypassed by road surface runoff.						Prescribed Action: Maintenance the rocked rolling dip per the specifications outlined in the attached BMPs. See attached BMPs: See Rocked/Rolling Dip Design and Placement, General Operations BMPs, and General Erosion Control specifications.	
Unique Point	Lat-Long NAD 83	Road Type	Mitigation Planned	Monitor	1600	Treatment Priority	Date Completed
77	-123.900414 40.14571	Seasonal	-	X	-	As required	
Current Condition: Functioning rolling dip.						Prescribed Action: Maintain the rolling dip to the specifications outlined in the attached BMPs. See attached BMPs: See Rocked/Rolling Dip Design and Placement, General Operations BMPs, and General Erosion Control specifications.	



SMP - Mitigation Report

WDID# - 1_12CC405506

Unique Point	Lat-Long NAD 83	Road Type	Mitigation Planned	Monitor	1600	Treatment Priority	Date Completed
78	-123.89996 40.146268	Seasonal	X	X	-	Prior to 10/15/19	
<p>Current Condition: Rolling dip that is rutting due to the lack of adequate rock surfacing and discharging sediment into the adjacent watercourse.</p>						<p>Prescribed Action: Apply more rock surfacing to the rolling dip and maintenance the rocked rolling dip per the specifications outlined in the attached BMPs. See attached BMPs: See Rocked/Rolling Dip Design and Placement, General Operations BMPs, and General Erosion Control specifications.</p>	
Unique Point	Lat-Long NAD 83	Road Type	Mitigation Planned	Monitor	1600	Treatment Priority	Date Completed
79	-123.900639 40.145378	Legacy	X	X	X	Prior to 10/15/21	
<p>Current Condition: Class II watercourse crossing consisting of a 24" corrugated metal pipe that is undersized, rusted through, shotgunned, and on a legacy road that is no longer used.</p>						<p>Prescribed Action: Crossing shall be abandoned to natural conditions as feasible. All road fill material shall be excavated from the channel and remaining side slopes laid back to a stable angle of 2:1 as feasible. The excavated channel shall have a consistent slope and width through the excavation matching the natural channel above and below the influence of the crossing fill. Exposed side slopes shall be planted with appropriate tree species and treated for erosion control measures. Erosion Control Measures shall include, but are not limited to, native grass seed, weed free straw, straw wattles, and jute netting. Excavated spoils material shall be stored on stable slopes, outside of any riparian area, where they cannot be transported away for the site by wind or rain, and treated for erosion control with seed and straw mulch and staked wattles around the spoils. See the attached BMPs: See Crossing Abandonment, General Operations BMPs, and General Erosion Control specifications.</p>	
Unique Point	Lat-Long NAD 83	Road Type	Mitigation Planned	Monitor	1600	Treatment Priority	Date Completed
80	-123.901653 40.145154	Legacy	X	X	X	Prior to 10/15/21	
<p>Current Condition: Class II watercourse crossing consisting of a 24" corrugated metal pipe that is under sized, shotgunned, rusted through, and eroding the fill under and around the outlet.</p>						<p>Prescribed Action: Crossing shall be abandoned to natural conditions as feasible. All road fill material shall be excavated from the channel and remaining side slopes laid back to a stable angle of 2:1 as feasible. The excavated channel shall have a consistent slope and width through the excavation matching the natural channel above and below the influence of the crossing fill. Exposed side slopes shall be planted with appropriate tree species and treated for erosion control measures. Erosion Control Measures shall include, but are not limited to, native grass seed, weed free straw, straw wattles, and jute netting. Excavated spoils material shall be stored on stable slopes, outside of any riparian area, where they cannot be transported away for the site by wind or rain, and treated for erosion control with seed and straw mulch and staked wattles around the spoils. See the attached BMPs: See Crossing Abandonment, General Operations BMPs, and General Erosion Control specifications.</p>	



SMP - Mitigation Report

WDID# - 1_12CC405506

Unique Point	Lat-Long NAD 83	Road Type	Mitigation Planned	Monitor	1600	Treatment Priority	Date Completed
81	-123.908562 40.142381	Permanent	X	X	X	Prior to 10/15/21 pending the approval of any required permits	
<p>Current Condition: Class II watercourse crossing consisting of a 6" pipe that is undersized, has a buried inlet and outlet, short in the fill, and has two PVC pipes in the pipe.</p>						<p>Prescribed Action: Replace the existing culvert with an 18" diameter culvert per the specifications outlined in the attached BMPs: See Permanent Culvert Crossing, Permanent Culvert Crossing Design: Critical Dip and Hydrologic Disconnect Placement, Critical Dip, Culvert Orientation, Inlet and Outlet Armoring, General Operations BMPs, and General Erosion Control specifications.</p>	
Unique Point	Lat-Long NAD 83	Road Type	Mitigation Planned	Monitor	1600	Treatment Priority	Date Completed
82	-123.906888 40.140445	Permanent	-	X	-	As required	
<p>Current Condition: Ditch relief culvert consisting of an 18" diameter corrugated plastic pipe that is installed correctly but is partially plugged with sediment and debris.</p>						<p>Prescribed Action: None. Maintain and monitor for plugging.</p>	
Unique Point	Lat-Long NAD 83	Road Type	Mitigation Planned	Monitor	1600	Treatment Priority	Date Completed
83	-123.906493 40.140258	Permanent	-	X	-	As required	
<p>Current Condition: Series of functioning kickoff drainage features.</p>						<p>Prescribed Action: Maintain per the specifications outlined in the attached BMPs. See attached BMPs: Steep Road Drainage, Waterbar Construction, General Operations BMPs, and General Erosion Control specifications.</p>	
Unique Point	Lat-Long NAD 83	Road Type	Mitigation Planned	Monitor	1600	Treatment Priority	Date Completed
84	-123.907071 40.142256	Permanent	X	X	X	Prior to 10/15/21 pending the approval of any required permits	
<p>Current Condition: Class III watercourse crossing consisting of a 12" diameter corrugated metal pipe that is undersized, rusted, too short, not-to-grade, signs of backing up, has metal sheeting armoring at the outlet concrete, and has concrete slurry armoring at the outlet.</p>						<p>Prescribed Action: Replace the existing culvert with an 30" diameter culvert per the specifications outlined in the attached BMPs: See Permanent Culvert Crossing, Permanent Culvert Crossing Design: Critical Dip and Hydrologic Disconnect Placement, Critical Dip, Culvert Orientation, Inlet and Outlet Armoring, General Operations BMPs, and General Erosion Control specifications.</p>	
Unique Point	Lat-Long NAD 83	Road Type	Mitigation Planned	Monitor	1600	Treatment Priority	Date Completed
85	-123.907552 40.142248	Permanent	X	X	X	Prior to 10/15/21 pending the approval of any required permits	
<p>Current Condition: Class III watercourse crossing consisting of a 12" diameter corrugated plastic pipe that is undersized and not-to-grade.</p>						<p>Prescribed Action: Replace the existing culvert with an 30" diameter culvert per the specifications outlined in the attached BMPs: See Permanent Culvert Crossing, Permanent Culvert Crossing Design: Critical Dip and Hydrologic Disconnect Placement, Critical Dip, Culvert Orientation, Inlet and Outlet Armoring, General Operations BMPs, and General Erosion Control specifications.</p>	



SMP - Mitigation Report

WDID# - 1_12CC405506

Unique Point	Lat-Long NAD 83	Road Type	Mitigation Planned	Monitor	1600	Treatment Priority	Date Completed
86	-123.905716 40.143482	-	X	X	-	Immediately	
<p>Current Condition: Four two-thousand gallon fuel tanks. Three have adequate secondary containment but with no cover from precipitation. A generator and the fourth two-thousand gallon fuel tank has secondary containment and cover from precipitation.</p>						<p>Prescribed Action: Do not use the three fuel tanks without cover from precipitation.</p>	
Unique Point	Lat-Long NAD 83	Road Type	Mitigation Planned	Monitor	1600	Treatment Priority	Date Completed
Cultivation Area E	N/A	-	X	X	-	As required	
<p>Current Condition: Cultivation Area E to be relocated once approved by Humboldt County. If the cultivation area relocation is not approved, the prescribed treatment will be the same and the cultivation area within riparian setbacks, as shown on attached Site Maps, shall be removed.</p>						<p>Prescribed Action: Remove any remaining fencing, pots, or other cultivation-related wastes and materials from these areas. Seed and mulch the Past Cultivation Area, and any Disturbed Area associated with its removal, with native grass seed and weed free straw(or woodchips). If cultivation soil is not re-used, contour the cultivation-related soils into the ground outside of any riparian buffer areas, and seed and mulch the contoured soils with native grass seed and weed free straw.</p>	
Unique Point	Lat-Long NAD 83	Road Type	Mitigation Planned	Monitor	1600	Treatment Priority	Date Completed
Past Cultivation Areas	N/A	-	X	X	-	Immediately	
<p>Current Condition: Past cultivation areas that are no longer used with remaining cultivation-related materials, fencing, wastes, and soils.</p>						<p>Prescribed Action: Remove any remaining fencing, pots, or other cultivation-related wastes and materials from these areas. Seed and mulch the Past Cultivation Area, and any Disturbed Area associated with its removal, with native grass seed and weed free straw(or woodchips). If cultivation soil is not re-used, contour the cultivation-related soils into the ground outside of any riparian buffer areas, and seed and mulch the contoured soils with native grass seed and weed free straw.</p>	
Unique Point	Lat-Long NAD 83	Road Type	Mitigation Planned	Monitor	1600	Treatment Priority	Date Completed
Water Storage and Use	N/A	-	X	X	-	Immediately	
<p>Current Condition: At present there are no devices or procedures in place to record water usage on all of the Points of Diversion associated with the irrigation of cannabis, domestic use, and water used by the hydroelectric system. There is only one device that records water used for the irrigation of cannabis currently.</p>						<p>Prescribed Action: Water meters to monitor water usage shall be used to record all diverted and used water for the irrigation of cannabis, domestic use, and water used by the hydroelectric system. Monthly water usage shall be recorded for annual reporting purposes.</p>	



SMP - Mitigation Report

WDID# - 1_12CC405506

Unique Point	Lat-Long NAD 83	Road Type	Mitigation Planned	Monitor	1600	Treatment Priority	Date Completed
Liquid Petroleum Products	N/A	-	X	X	-	Immediately	
<p>Current Condition: All liquid petroleum products (e.g. any size container of any petroleum product) requires secondary containment while not in immediate use and cover from precipitation during the wet season. Adequate quantities of absorbent materials shall also be stored at all locations where these types of materials are used and stored.</p>						<p>Prescribed Action: Any/all liquid petroleum products and their containers shall be stored in secondary containment (e.g. plastic totes or sealed metal boxes) while being stored long term or not in immediate use, wherever these materials are used anywhere on the property. Adequate quantities of absorbent materials shall be stored at all locations where these types of materials are used and stored. Should a spill of these materials occur, absorbent materials will be applied immediately and allowed enough time to absorb as much material as possible. Following treatment, absorbent materials applied as well as any contaminated soil will be removed and disposed of appropriately for the spilled material.</p>	
Unique Point	Lat-Long NAD 83	Road Type	Mitigation Planned	Monitor	1600	Treatment Priority	Date Completed
Generators and Gas Powered Pumps	N/A	-	X	X	-	Immediately	
<p>Current Condition: All liquid petroleum powered generators and pumps require secondary containment, and cover from precipitation during the wet season. Adequate quantities of absorbent materials shall also be stored at all locations where the generators and gas powered pumps are used and stored.</p>						<p>Prescribed Action: Any/all petroleum products and other liquid chemicals, including but not limited to diesel, biodiesel, gasoline, and oils shall be stored in above ground storage tanks and containers shall be provided with a secondary means of containment for the entire capacity of the largest single container and sufficient cover shall be provided to prevent any/all precipitation from entering said secondary containment vessel so as to prevent their spillage, discharge, or seepage into receiving waters. Adequate quantities of absorbent materials shall be stored at all locations where these types of materials are used and stored. Should a spill of these materials occur, absorbent materials will be applied immediately and allowed enough time to absorb as much material as possible. Following treatment, absorbent materials applied as well as any contaminated soil will be removed and disposed of appropriately for the spilled material.</p>	
Unique Point	Lat-Long NAD 83	Road Type	Mitigation Planned	Monitor	1600	Treatment Priority	Date Completed
3-acre Conversion Area	N/A	-	X	X	-	Immediately	
<p>Current Condition: Disturbed area of bare mineral soils with no erosion control measures being implemented.</p>						<p>Prescribed Action: Seed and mulch all bare ground with grass seed and weed free straw(or woodchips). Straw or wood chips shall be spread to a depth of approximately 2- 4" deep on top of dispersed grass seed. Alternatively, woodchips can be used. See General Erosion Control specifications.</p>	

WDID: _____

Date: _____

Monthly Water Tracking

Month	Total Surface Water Diversion	Water input to Storage by Source	Water use by Source
January			
February			
March			
April			
May			
June			
July			
August			
September			
October			
November			
December			

WDID: _____

Date: _____

Monthly Water Tracking



165 South Fortuna Boulevard, Fortuna, CA 95540
707-725-1897 • fax 707-725-0972
trc@timberlandresource.com

BMP: Water Meters



Metering device(s) and/or a procedure (if the water source is completely non-jurisdictional e.g. wells or off-stream pond with no inputs from surface water diversions) to monitor water usage shall be used to record all water used for the irrigation of cannabis and domestic use. No matter the source or means of measurement, per the State General Order, all water used for the irrigation of cannabis shall be recorded daily and recorded water use data shall be kept and maintained for 5 years. Water use may be recorded by meter(s), calculated irrigation times, pump and fill, tank measurements, or any other reasonably accurate means. These records are to be current, maintained, kept on site, and presentable should they be requested. Monthly water usage shall be recorded for annual reporting purposes. For surface water diversions which are used at any point to provide water for the irrigation of cannabis, metering device(s) shall be installed immediately to record water diversion as it is diverted. Records of diverted surface water shall be kept and maintained for 5 years. These records are to be current, maintained, kept on site, and presentable should they be requested.

If surface water is also used for domestic uses, domestic water is to be metered separately from water used for the irrigation of cannabis and is required the same recording and record keeping as water used for cannabis. Water meter(s), or water usage procedures, and water supply infrastructure shall be designed/installed in a manner such that water usage for the irrigation of cannabis can be recorded separately from water used for domestic use. Additionally, if there are multiple diversions of surface water, infrastructure/metering device(s) shall be design/installed in a manner that each source of surface water is recorded separately.

State of California list of approved water meters and other measurement devices

- https://www.waterboards.ca.gov/waterrights/water_issues/programs/diversion_use/wm_vendors.html

Approved water meter provider (top link on the state waterboards list)

- <http://www.watermeters.com/>

Direct link to applicable meters from the www.watermeters.com website

- http://shop.watermeters.com/Cold-Water-Meters_c2.htm
Specifications <http://www.jerman.com/dljameter.html>
- http://shop.watermeters.com/Polymer-Cold-Water-Meters_c7.htm
Specifications <http://www.jerman.com/plasmeter.html>

BMP: Generator, Fuel, and Oil Management

All bulk fuel storage or petroleum products, any/all future petroleum products and other liquid chemicals, including but not limited to diesel, biodiesel, gasoline, and oils shall be stored so as to prevent their spillage, discharge, or seepage into receiving waters. Storage tanks and containers shall be of suitable material and construction to be compatible with the substance(s) stored and conditions of storage such as pressure and temperature. Above ground storage tanks and containers shall be provided with a secondary means of containment for the entire capacity of the largest single container and sufficient cover shall be provided to prevent any/all precipitation from entering said secondary containment vessel.

If the volume of a fuel container is greater than 1,320 gallons, a Spill Prevention, Control, and Countermeasures (SPCC) plan will be required for the use the fuel tank.

On-site storage of petroleum products, or other fuels used for commercial activities may require registration as hazardous materials through the California Environmental Reporting System (CERS). Additionally, the waste oil generated from commercial activities (generators) and their used oil filters are considered hazardous waste and requires additional reporting. The discharger is advised to contact local agencies to find out if such reporting is applicable to currently operations

Used motor oil is recommended to be stored in sealed containers that the oil was originally packaged in, e.g. sealed buckets/quart or gallon jugs, or other sealed containers designed to store motor oil. Stored used oil is recommended to be regularly disposed of at hazardous waste disposal sites. Used oil filters are also recommended to be stored in sealed containers, e.g. sealed plastic totes/buckets, for later disposal at a hazardous waste disposal site. These storage containers are recommended to be stored in structures where they are protected from precipitation.

Further information regarding the State of California's requirements for the managing of Used Oil and Oil Filters can be found by entering the links below or searching the corresponding titles to the links.

California Department of Toxic Substances Control - Used Oil Generator Requirements

- <https://www.dtsc.ca.gov/InformationResources/upload/RAG-UsedOilforGenerators.pdf>

Department of Toxic Substances Control - Managing Used Oil Filters for Generator

- https://www.dtsc.ca.gov/InformationResources/upload/RAG_Used-Oil-Filters_Generators1.pdf

BMP: Generator, Fuel, and Oil Management (Generators and Pumps)

All generators and petroleum powered pumps shall have spill trays or secondary containment placed underneath them when using, fueling, or changing oil on them to prevent the potential for leeching, seepage or spillage of petroleum products. All spill trays and containment structures require cover from precipitation if used or left out over the winter period. All generators and petroleum powered pump locations shall have spill cleanup kits on hand.

Pre-fabricated secondary containment structures and spill trays can be purchased online or from local wholesalers of petroleum products. As an alternative to pre-fabricated secondary containment structures, structures can be constructed from wooden, cinderblock, concrete, or metal frames lined with PVC liners, e.g. pond liner/water bladder material, as long as the containment is fully sealed and constructed in a similar manner to examples of pre-fabricated containment structures found below. Ensure that diked areas are sufficiently impervious to contain discharged chemicals. All containment structures require cover from precipitation to prevent the containment from filling with water. Secondary containment for fuel tanks shall not be constructed.

As an alternative to pre-fabricated spill kits, kits can consist of sealed trashcans or buckets with industrial absorbent material (e.g. cat litter) and shovels, placed nearby any location where generators, pumps, or other petroleum products or chemicals are used.

Examples of industry standard pre-fabricated spill containment and clean-up kits can be found following or entering the links below. Pre-fabricated spill containment and clean-up kits can be purchased online, from Renner Petroleum, or other similar industry providers.

Ultratech Spill Containment

- <http://www.spillcontainment.com/categories/spill-containment/>

New Pig Portable and Collapsible Spill Containment

- <https://www.newpig.com/collapsible-berms/c/5142?show=All>

BMP: Generator, Fuel, and Oil Management



Example of a small, portable, and compact containment berm.



Example of a portable utility spill tray.

BMP: Generator, Fuel, and Oil Management



Example of secondary containment for a fuel tank. This container requires cover from precipitation.



Example of spill pallets for unused or used oil drums and other petroleum products.

BMP: Winterization and Interim Treatments for Erosion Control

- **Roads**
 - Existing or newly installed road surface drainage structures such as water bars, rolling dips, ditch relief culverts, and intentionally in/out-sloped segments of road shall be maintained to ensure continued function of capturing and draining surface runoff.
 - Hand tool kick-outs (lead out ditch) for existing wheel rut, surface run-off confinement.
 - Temporary waterbar/cross-wattles installed on road/trail sections of concentrating surface runoff.
 - Clean existing ditch relief culvert inlets, outlets, and contributing ditch lines of current and potential blockage debris by hand.
 - Hand place energy dissipating rock/small woody debris at ditch relief culvert outlets where erosion is occurring.
 - Wattles/straw bales placed at road runoff delivery sites.
 - Touch-up with hand tools of existing surface drainage structures (kick-outs, rolling dips, and waterbars).
 - Seed and straw un-used, or to be abandoned, road surfaces where erosion is occurring.
 - Frequent use of un-surfaced roads should be avoided, particularly when road surfaces are soft/saturated.

- **Crossings**
 - Clean inlets, outlets, and channels above of current and potential blockage debris by hand.
 - Hand place energy dissipating rock/small woody debris at ditch relief culvert outlets.
 - Hand placement of rock armor around culvert inlets.
 - Install staked wattles along the outboard road edge of out-sloped watercourse crossings where direct delivery of road surface runoff is occurring.
 - Hand placement of rock on crossing fill faces where erosion is/may occur as a result of poor crossing construction.

- **Cultivation Areas**
 - Use hand tools to capture cultivation related soils that are not contained (soil from post-harvest plant removal, soil/planter removal, general spillage).
 - Treat beds, pots, new soil storage piles, spent soil piles, and soil disposal piles with cover crops for soil stability and potentially nitrogen fixing/soil amendment.
 - Bagged potting soil should be covered.
 - Install staked wattles or an earthen berm around cultivation soils piles prior to the winter period, annually.
 - Any soil amendment, fertilizer, herbicide, or pesticide that is not 100% sealed should be stored under cover.
 - Cultivation sites with poor or concentrating drainage can have wattles or bales installed prior to winter to help prevent sediment and nutrients from leaving the site.
 - Plastic netting shall be disposed of or stored where it is inaccessible to wildlife.
 - Tarps/dep covers shall be stored so they cannot be blown away.
 - General waste from growing season gathered up and disposed of.
 - Exposed soil surfaces in the cultivation area, as well as graded fill slopes should be seeded, strawed, mulched, jute netted as needed.

- **General Areas**
 - Remove all refuse prior to leaving property for the season.
 - Back fill pit toilets to be abandoned.

BMP: General Recommendations

- **Fertilizers, soil amendments, and pesticides**
 - Fertilizer, soil amendments, and pesticide use it to be recorded in such a manner that cumulative annual totals are recorded for annual reporting.
 - Store in-use fertilizers in a securable storage container, such as a tote or deck box, adjacent to the mixing tanks.

- **Petroleum products and hazardous materials**
 - Utilize spill trays/containment structures and cover over the containment when using, fueling, changing oil on portable generators or petroleum powered water pumps to prevent the potential for leeching, seepage or spillage of petroleum products.
 - It is recommended that all petroleum products and other chemicals are registered with the California Environmental Reporting System (CERS) to satisfy future licensing requirements.

- **Water storage and Use**
 - Water use shall be designed and metered such that water used for the irrigation of cannabis will be recorded separately from domestic use. Water use for the irrigation of cannabis is to be recorded monthly for annual reporting.
 - Ensure lids are secured on all water storage tanks to prevent wildlife from becoming entrapped within the tank.
 - Install float valves, or implement another equivalent system, on all applicable water storage and transfer tanks to prevent unnecessary water diversion and the overflowing of water tanks.

BMP: General Operations BMPs

- If operations require moving of equipment across a flowing stream, such operations shall be conducted without causing a prolonged visible increase in stream turbidity. For repeated crossings, the operator shall install a bridge, culvert, or rock-lined crossing.
- During construction in flowing water, which can transport sediment downstream, the flow shall be diverted around the work area by pipe, pumping, temporary diversion channel or other suitable means. When any dam or artificial obstruction is being constructed, maintained, or placed in operation, sufficient water shall at all times be allowed to pass downstream to maintain fish life below the dam. Equipment may be operated in the channel of flowing live streams only as necessary to construct the described construction.
- Disturbance or removal of vegetation shall not exceed the minimum necessary to complete operations. The disturbed portion of any stream channel shall be restored to as near their original condition as possible. Restoration shall include the mulching of stripped or exposed dirt areas at crossing sites prior to the end of the work period.
- Structures and associated materials not designed to withstand high seasonal flow shall be removed to areas above the high-water mark before such flows occur.
- No debris, soil, silt, sand, bark, slash, sawdust, rubbish, cement or concrete washing, oil or petroleum products, or other organic or earthen material from any logging, construction, or associated activity of whatever nature shall be allowed to enter into or be placed where it may be washed by rainfall or runoff into waters of the State. When operations are completed, any excess materials or debris shall be removed from the work area. No rubbish shall be deposited within 150 feet of the high-water mark of any stream.

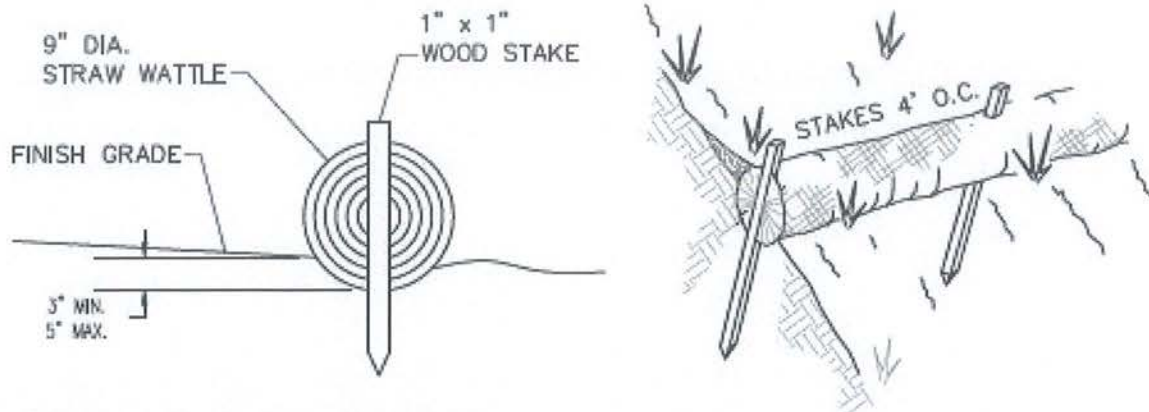
BMP: General Erosion Control

- Timing for soil stabilization measures within the 100 feet of a watercourse or lake: For areas disturbed from May 1 through October 15, treatment shall be completed prior to the start of any rain that causes overland flow across or along the disturbed surface. For areas disturbed from October 16 through April 30, treatment shall be completed prior to any day for which a chance of rain of 30 percent or greater is forecast by the National Weather Service or within 10 days, whichever is earlier.
- Within 100 feet of a watercourse or lake, the traveled surface of logging roads shall be treated to prevent waterborne transport of sediment and concentration of runoff that results from operations. Treatment may consist of, but not limited to, rocking, out sloping, rolling dips, cross drains, water bars, slope stabilization measures, or other practices appropriate to site-specific conditions.
- The treatment for other disturbed areas within 100 feet of a watercourse or lake, including: (A) areas exceeding 100 contiguous square feet where operations have exposed bare soil, (B) approaches to road watercourse crossings out to 100 feet or the nearest drainage facility, whichever is farthest, (C) road cut banks and fills, and (D) any other area of disturbed soil that threatens to discharge sediment into waters in amounts deleterious to the quality and beneficial uses of water, shall be grass seeded and mulched with straw or fine slash. Grass seed shall be applied at a rate exceeding 100 pounds per acre. Straw mulch shall be applied in amounts sufficient to provide at least 2- 4-inch depth of straw with minimum 90% coverage. Slash may be substituted for straw mulch provided the depth, texture, and ground contact are equivalent to at least 2 – 4 inches of straw mulch. Any treated area that has been subject to reuse or has less than 90% surface cover shall be treated again prior to the end of operations.
- Within 100 feet of a watercourse or lake, where the undisturbed natural ground cover cannot effectively protect beneficial uses of water from operations, the ground shall be treated with slope stabilization measures described in #3 above per timing described in #1 above.
- Side cast or fill material extending more than 20 feet in slope distance from the outside edge of a landing which has access to a watercourse or lake shall be treated with slope stabilization measures described in #3 above. Timing shall occur per #1 above unless outside 100 feet of a watercourse or lake, in which completion date is October 15.
- All roads shall have drainage and/or drainage collection and storage facilities installed as soon as practical following operations and prior to either (1) the start of any rain which causes overland flow across or along the disturbed surface within 100 feet of a watercourse or lake protection, or (2) any day with a National Weather Service forecast of a chance of rain of 30 percent or more, a flash flood warning, or a flash flood watch.

BMP: General Erosion Control (Cont.)

- Erosion control and sediment detention devices and materials shall be incorporated into the cleanup/restoration work design and installed prior to the end of project work and before the beginning of the rainy season. Any continuing, approved project work conducted after October 15 shall have erosion control works completed up-to-date and daily.
- Erosion control materials shall be, at minimum, stored on-site at all times during approved project work between May 1 and October 15.
- Approved project work within the 5-year flood plain shall not begin until all temporary erosion controls (straw bales or silt fences that are effectively keyed-in) are installed downslope of cleanup/restoration activities.
- Non-invasive, non-persistent grass species (e.g., barley grass) may be used for their temporary erosion control benefits to stabilize disturbed slopes and prevent exposure of disturbed soils to rainfall.
- Upon work completion, all exposed soil present in and around the cleanup/restoration sites shall be stabilized within 7 days.
- Soils exposed by cleanup/restoration operations shall be seeded and mulched to prevent sediment runoff and transport.
- Straw Wattles (if used) shall be installed with 18 or 24-inch wood stakes at four feet on center. The ends of adjacent straw wattles shall be abutted to each other snugly or overlapped by six inches. Wattles shall be installed so that the wattle is in firm contact with the ground surface.

BMP: General Erosion Control (Cont.)

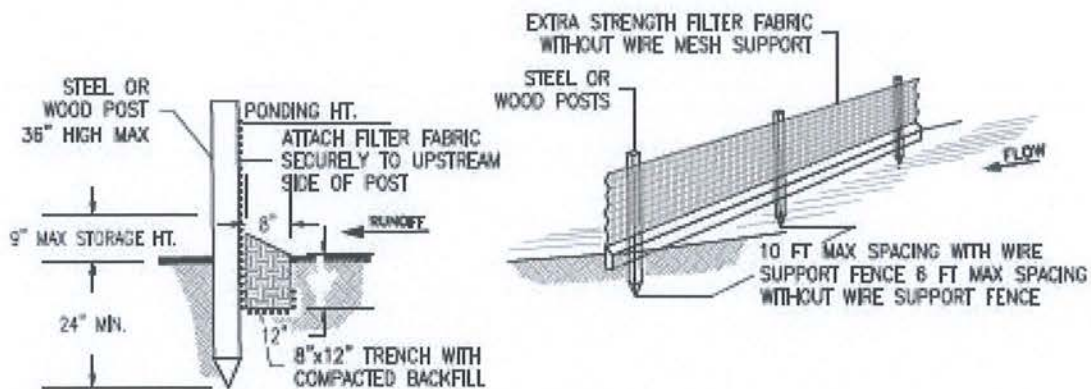


STRAW WATTLE NOTES:

1. STRAW WATTLES SHALL BE INSTALLED WITH 18 OR 24 INCH WOOD STAKES AT FOUR FEET ON CENTER. THE ENDS OF ADJACENT STRAW WATTLES SHALL BE ABUTTED TO EACH OTHER SNUGLY OR OVERLAPPED BY SIX INCHES.
2. STRAW ROLL INSTALLATION REQUIRES THE PLACEMENT AND SECURE STAKING OF THE ROLL IN A TRENCH, 3"-5" DEEP. RUNOFF MUST NOT BE ALLOWED TO RUN UNDER OR AROUND THE ROLL.

STRAW WATTLE INSTALLATION DETAIL

NTS



SILT FENCE NOTES:

1. THE CONTRACTOR SHALL INSPECT AND REPAIR FENCE AFTER EACH STORM EVENT.
2. CONTRACTOR SHALL REMOVE SEDIMENT AS NECESSARY. REMOVED SEDIMENT SHALL BE DEPOSITED TO AN AREA THAT WILL NOT CONTRIBUTE SEDIMENT OFF-SITE AND IN AN AREA THAT CAN BE PERMANENTLY STABILIZED.
3. SILT FENCE SHALL BE PLACED ON SLOPE CONTOURS TO MAXIMIZE PONDING EFFICIENCY.

SILT FENCE DETAILS

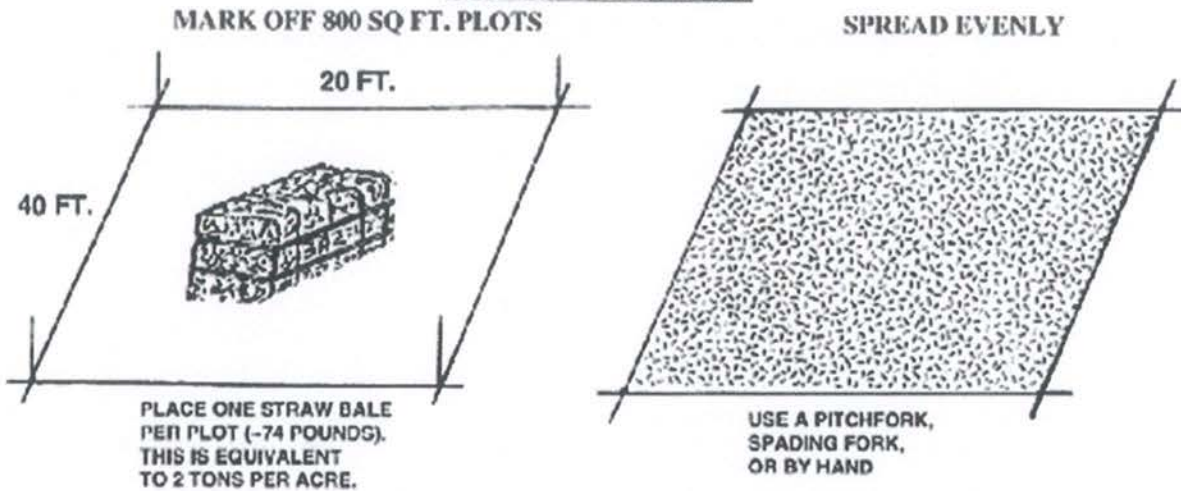
NTS

BMP: General Erosion Control (Cont.)

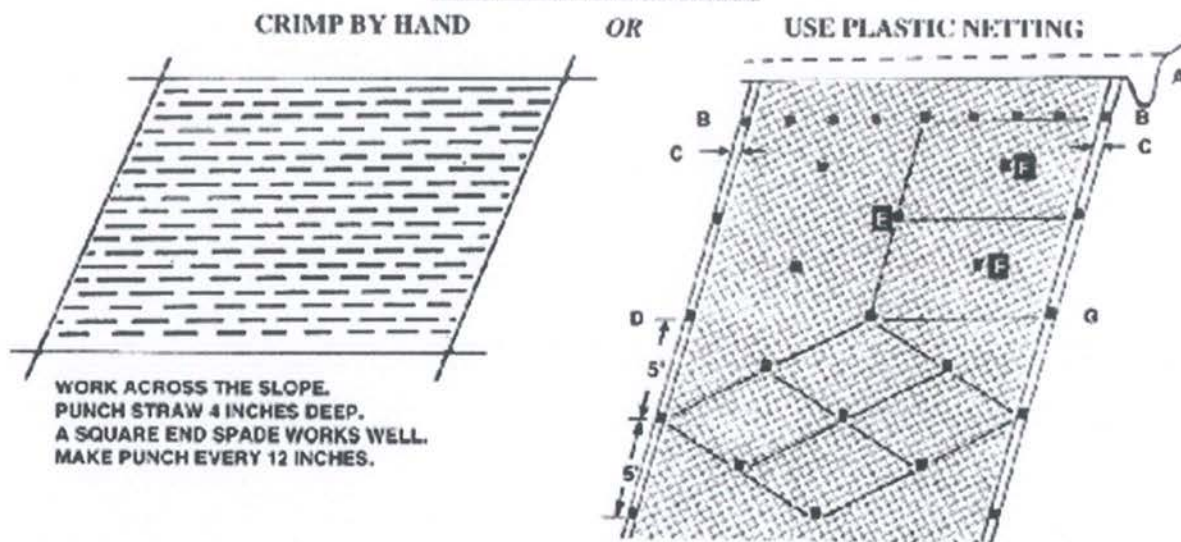


BMP: General Erosion Control (Cont.)

SPREAD THE STRAW



ANCHOR THE STRAW

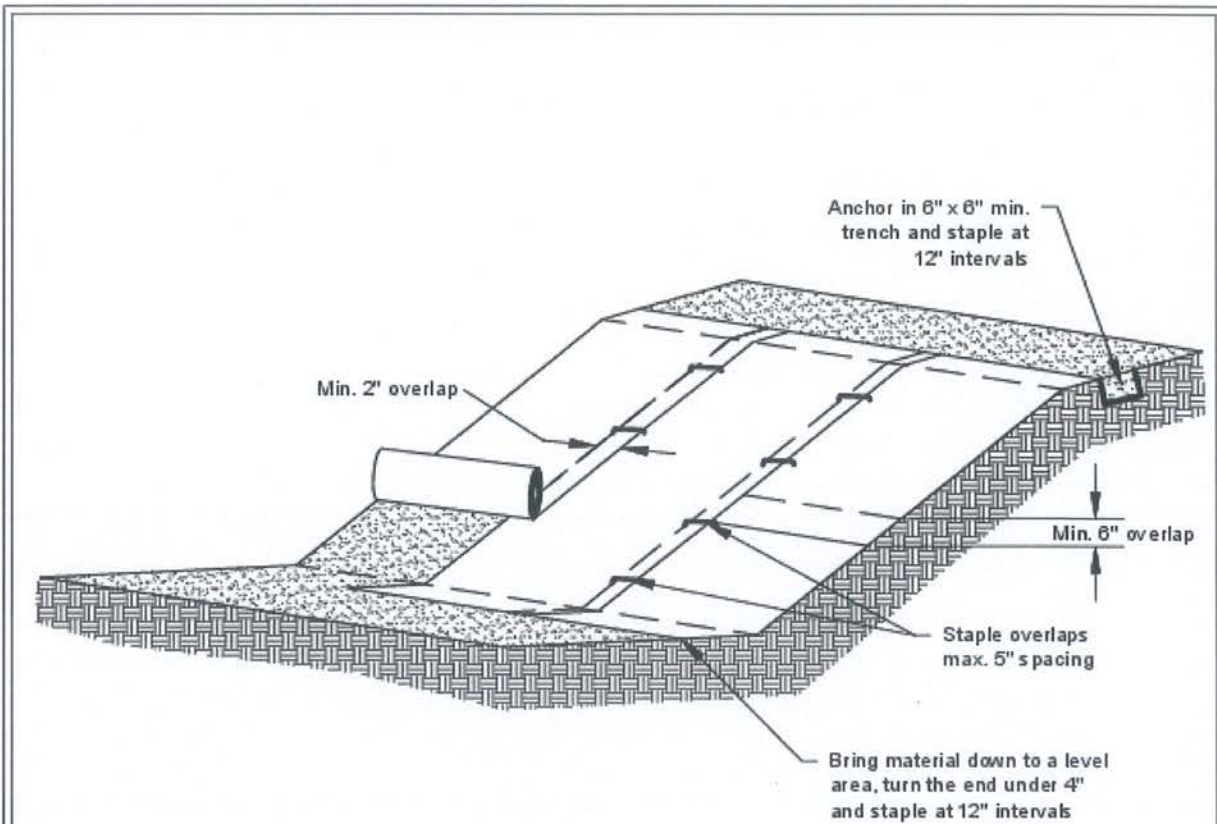


- A. LAY BIRD CONTROL NETTING OR SIMILAR MATTING IN STRIPS DOWN THE SLOPE OVER THE STRAW. BURY UPPER END IN 6-8 INCH DEEP AND WIDE TRENCH.. MOST NETTING COMES IN 14 TO 17 FT. WIDE ROLLS.
- B. SECURE THE UPPER END WITH STAKES EVERY 2 FEET.
- C. OVERLAP SEAMS ON EACH SIDE 4-5 INCHES.
- D. SECURE SEAMS WITH STAKES EVERY 5 FEET.
- E. STAKE DOWN THE CENTER EVERY 5 FEET.

- F. STAKE MIDDLES TO CREATE DIAMOND PATTERN THAT PROVIDES STAKES SPACED 4-5 FEET APART.
- G. USE POINTED 1X2 INCH STAKES 8 TO 9 INCHES LONG. LEAVE 1 TO 2 INCH TOP ABOVE NETTING, OR USE "U" SHAPED METAL PINS AT LEAST 9 INCHES LONG.

NOTE: WHEN JOINING TWO STRIPS, OVERLAP UPPER STRIP 3 FEET OVER LOWER STRIP AND SECURE WITH STAKES EVERY 2 FEET LIKE IN "B" ABOVE

BMP: General Erosion Control (Cont.)



Notes:

1. Slope surface shall be smooth before placement for proper soil contact.
2. Stapling pattern as per manufacturer's recommendations.
3. Do not stretch blankets/matting tight - allow the rolls to mold to any irregularities.
4. For slopes less than 3H:1V, rolls may be placed in horizontal strips.
5. If there is a berm at the top of the slope, anchor upslope of the berm.
6. Lime, fertilize, and seed before installation. Planting of shrubs, trees, etc. should occur after installation.

NOT TO SCALE



DEPARTMENT OF
ECOLOGY
State of Washington

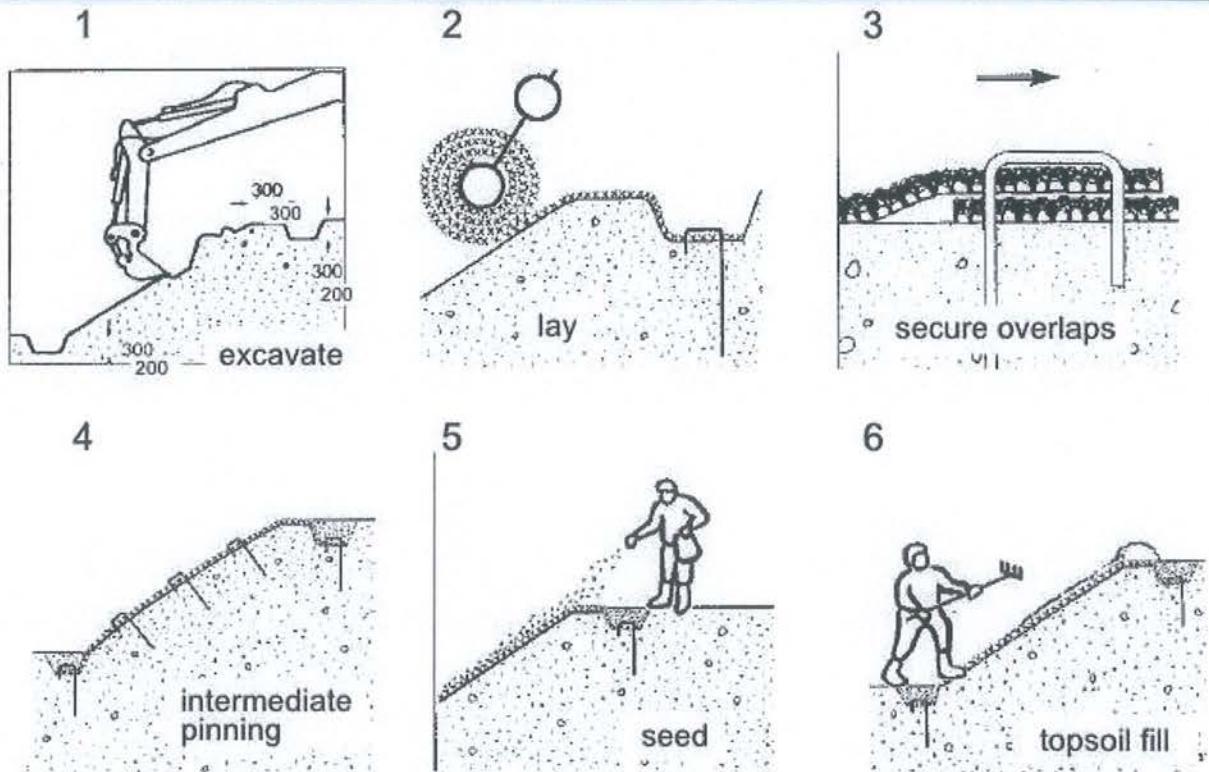
Slope Installation

Revised June 2016

Please see <http://www.ecy.wa.gov/copyright.html> for copyright notice including permissions, limitation of liability, and disclaimer.

BMP: General Erosion Control (Cont.)

Installation of a geosynthetics mat - Enkamat



Erosion Control Measures (Cont.)

Erosion Control Matting & Silt Fencing



Jute netting & Straw-wattles



BMP: General Erosion Control (Cont.)

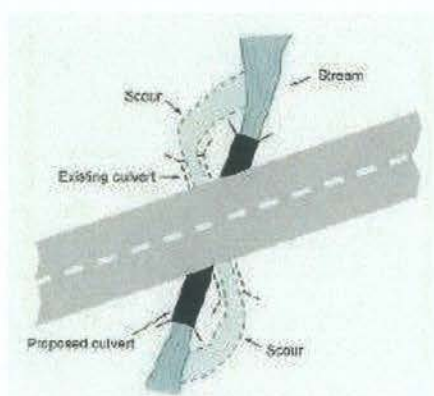
TABLE 34. Guidelines for erosion and sediment control application

Timing of application	Technique	Portion of road and construction area treated
Erosion control during construction	Hydromulching, hydroseeding	Road fill slopes, cut slopes, bare soil areas
	Dry seeding	Road fill slopes, cut slopes, bare soil areas
	Wood chip, straw, Excelsior or tackified mulch	Road fill slopes, cut slopes, bare soil areas
	Straw wattles	Road fill slopes and cut slopes
	Gravel surfacing	Road, landing and turnout surfaces
	Dust palliative	Road surfaces
	Minimize disturbance (soil and vegetation)	All areas peripheral to construction
Sediment control during construction	Sediment basin	Roadside ditches, turnouts and small stream crossings
	Sediment traps (e.g., silt fences, straw bales barriers, woody debris barriers)	Road fill slopes, cutbanks, bare soil areas and ditches
	Straw bale dams	Ditches and small streams
	Sumps and water pumps	Stream channels and stream crossings
	Streamflow diversions (e.g., temporary culverts, flex pipe, etc.)	Stream channels and stream crossings
Permanent erosion control	Surface diversion and dispersion devices (pipes, ditches, etc.)	All disturbed bare soil areas
	Road shaping	Road and landing surfaces
	Gravel surfacing	Road, landing and turnout surfaces
	Bituminous or asphalt surfacing	Road surface
	Rolling dips	Road surface
	Ditch relief culverts	Roadbed and road fill
	Downspouts and berm drains	Road fill slopes
	Waterbars	Road and landing surfaces
	Berms	Road surface and roadside areas
	Ditches	Road and landing surfaces
	Riprap	Road fill slopes, stream crossing fills, cutbanks, stream and lake banks
	Soil bioengineering	Road fill slopes, cut slopes, stream crossings, streambanks
Tree planting	Road fill slopes, cutbanks, bare soil areas, stream crossings, streambanks	

HANDBOOK FOR FOREST, RANCH AND RURAL ROADS

BMP: Permanent Culvert Crossing

- New culvert installations shall be sized to accommodate flows associated with a 100-year storm event.
- If the new culvert is replacing a poorly installed old culvert, the crossing may need to be abandoned to the following standard:
 - When fills are removed they shall be excavated to form a channel that is as close as feasible to natural watercourse grade and orientation, and that is wider than the natural channel.
 - Excavated banks shall be laid back to a 2:1 (50%) or natural slope.
- New culverts shall be placed at stream gradient, or have downspouts, or have energy dissipaters at outfall.
 - Align culverts with the natural stream channel orientation to ensure proper function, prevent bank erosion, and minimize debris plugging. See Figure 97 below.
 - Place culverts at the base of the fill and at the grade of the original streambed or install a downspout past the base of the fill. Downspouts should only be installed if there are no other options.
 - Culverts should be set slightly below the original stream grade so that the water drops several inches as it enters the pipe.
 - Culvert beds should be composed of rock-free soil or gravel, evenly distributed under the length of the pipe.
 - Compact the base and sidewall material before placing the pipe in its bed.
 - Lay the pipe on a well-compacted base. Poor basal compaction will cause settling or deflection in the pipe and can result in separation at a coupling or rupture in the pipe wall.
 - Backfill material should be free of rocks, limbs, or other debris that could dent or puncture the pipe or allow water to seep around the pipe.
 - Cover one end of the culvert pipe, then the other end. Once the ends are secure, cover the center.
 - Tamp and compact backfill material throughout the entire process, using water as necessary for compaction.
 - Backfill compacting will be done in 0.5 – 1.0 foot lifts until 1/3 of the diameter of the culvert has been covered.
 - Push layers of fill over the crossing to achieve the final design road grade, road fill above the culvert should be no less than one-third to one-half the culvert diameter at any point on the drivable surface.
- Critical dips shall be installed on culvert crossings to eliminate diversion potential. Refer to Figure 84 below.
- Road approaches to crossings shall be treated out to the first drainage structure (i.e. waterbar, rolling dip, or hydrologic divide) to prevent transport of sediment.
- Road surfaces and ditches shall be disconnected from streams and stream crossings to the greatest extent feasible. Ditches and road surfaces that cannot be feasible disconnected from streams or stream crossings shall be treated to reduce sediment transport to streams.
- If downspouts are used, they shall be secured to the culvert outlet and shall be secure on fill slopes.
- Culverts shall be long enough so that road fill does not extend or slough past the culvert ends.
- Inlet of culverts, and associate fill, shall be protected with appropriate measures that extend at least as high as the top of the culvert.
- Outlet of culverts shall be armored with rock if road fill sloughing into channel can occur.
- Armor inlets and outlets with rock, or mulch and seed with grass as needed (not all stream crossings need to be armored).
- Where debris loads could endanger the crossing, a debris catchment structure shall be constructed upstream of the culvert inlet.
- Bank and channel armoring may occur, when appropriate, to provide channel and bank stabilization.



HANDBOOK FOR FOREST, RANCH AND RURAL ROADS

FIGURE 97. *Culvert alignment should be in relation to the stream and not the road. It is important that the stream enters and leaves the culvert in a relatively straight horizontal alignment so streamflow does not have to turn to enter the inlet or discharge into a bank as it exits. This figure shows a redesigned culvert installation that replaces the bending alignment that previously existed. Channel turns at the inlet increase plugging potential because wood going through the turn will not align with the inlet. Similarly, channel turns at the inlet and outlet are often accompanied by scour against the channel banks (Wisconsin Transportation Information Center, 2004).*

BMP: Permanent Culvert Crossing Design (Critical Dip and Hydrologic Disconnect Placement)

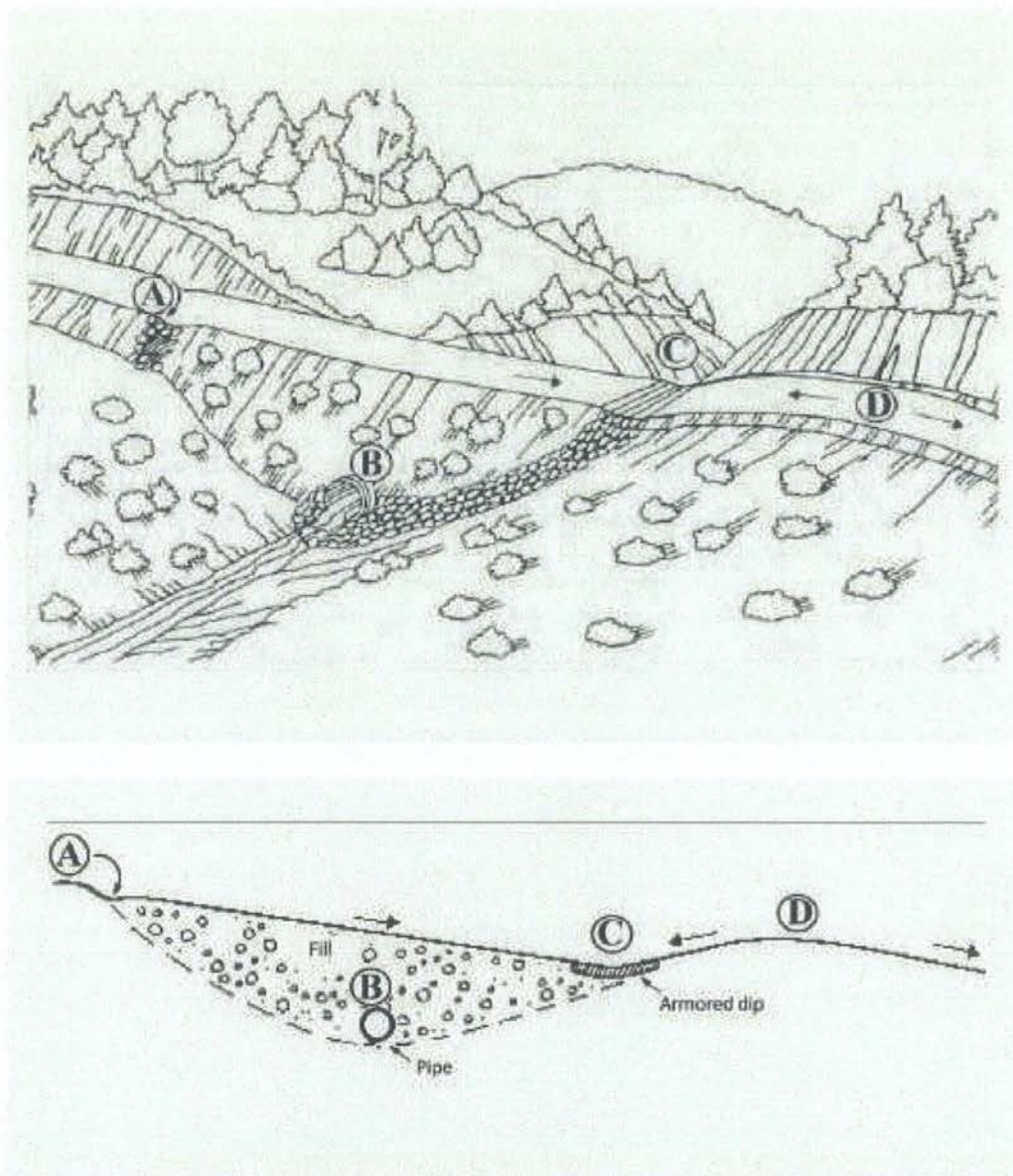
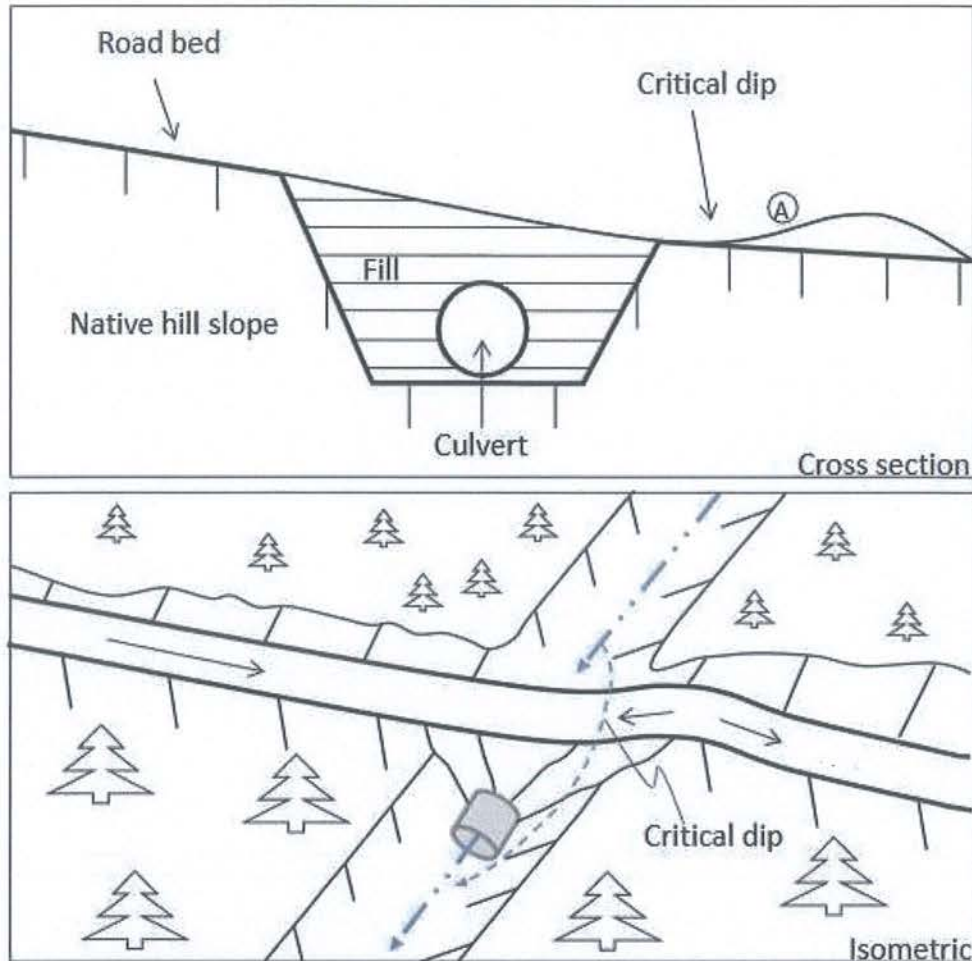


FIGURE 84. Critical dips or dipped crossing fills should be centered near a stream crossing's down-road hinge line, not over the centerline of the crossing where overtopping could cause washout or severe erosion of the fill. If the stream crossing culvert (B) plugs, water will pond behind the fill until reaching the critical dip or low point in the crossing (C) and flowing back down into the natural stream channel. The down-road ditch must be plugged to prevent streamflow from diverting down the ditch line. For extra protection in this sketch, riprap armor has been placed at the critical dip outfall and extending downslope to the stream channel. This is only required or suggested on stream crossings where the culvert is highly likely to plug and the crossing fill overtopped. The dip at the hinge line is usually sufficient to limit erosional damage during an overtopping event. Road surface and ditch runoff is disconnected from the stream crossing by installing a rolling dip and ditch relief culvert just up-road from the crossing (A) (Keller and Sherar, 2003).

BMP: Permanent Culvert Crossing Design (Critical Dip)

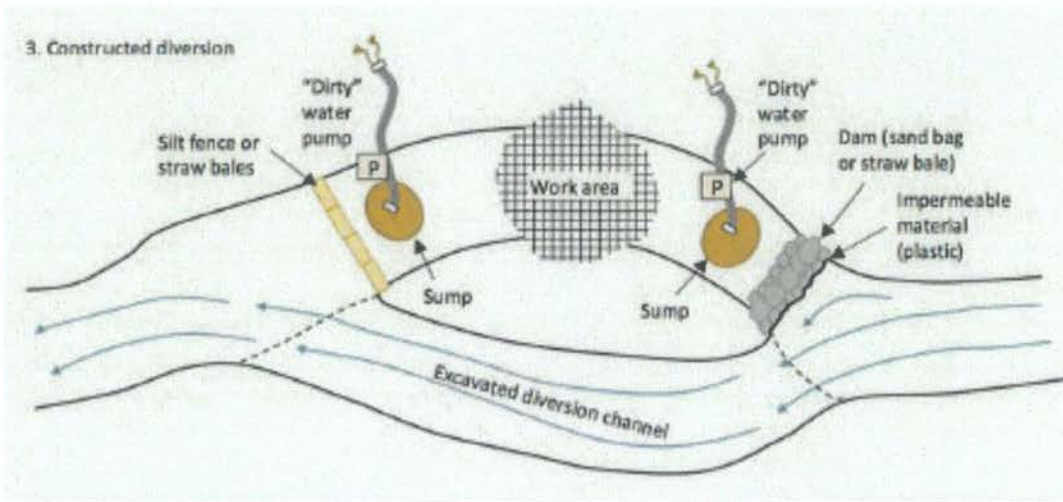
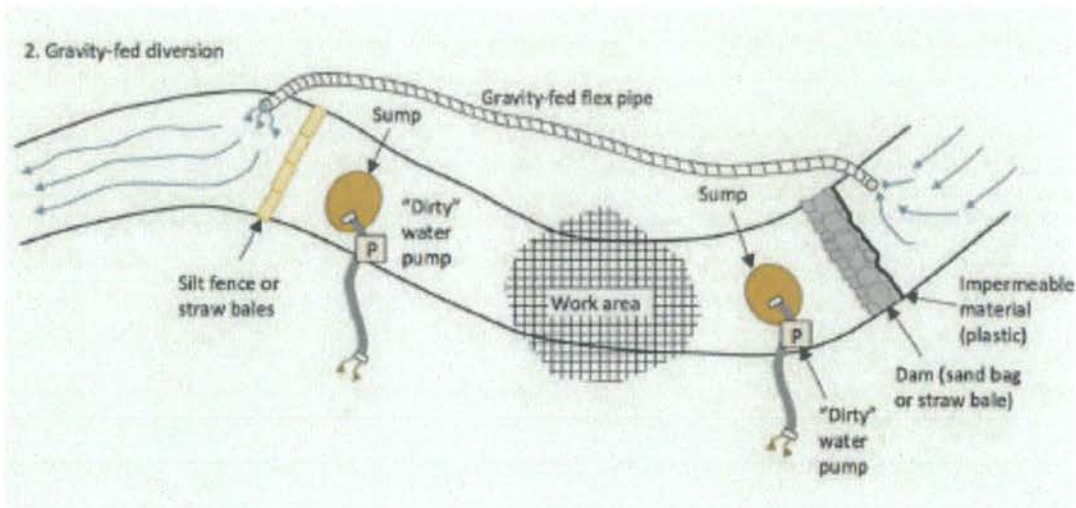
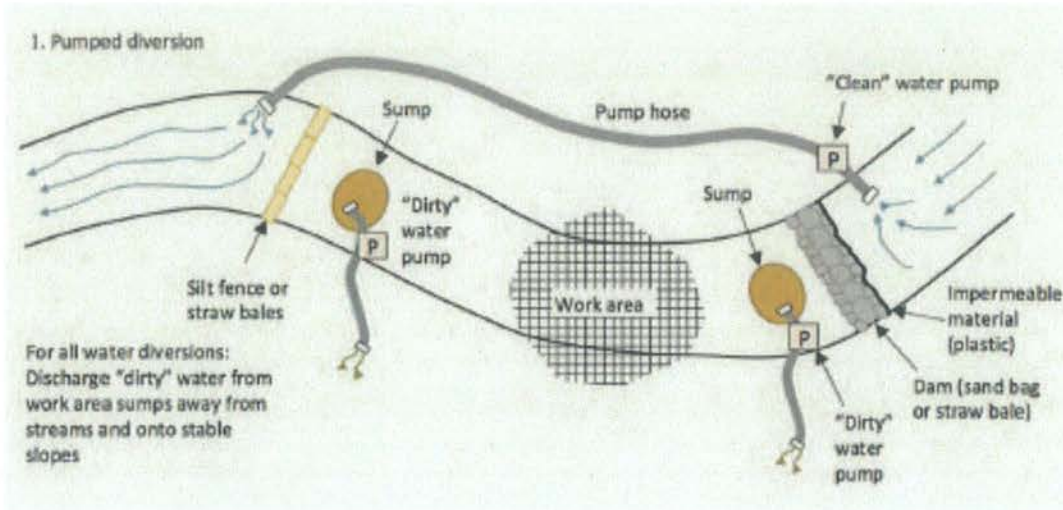
Typical Critical Dip Design for Stream Crossings with Diversion Potential



Critical Dip Construction:

1. Critical dip will be constructed on the lower side of crossing.
2. Critical dip will extend from the cutbank to the outside edge of the road surface. Be sure to fill inboard ditch, if present.
3. Critical dip will have a reverse grade (A) from cutbank to outside edge of road to ensure flow will not divert outside of crossing.
4. The rise in the reverse grade will be carried for about 10 to 20 feet and then return to original slope.
5. The transition from axis of bottom, through rising grade, to falling grade, will be in the road distance of at least 15 to 30 feet.
6. Critical dips are usually built perpendicular to the road surface to ensure that flow is directed back into the stream channel.

BMP: Permanent Culvert Crossing Design (Cofferdam Construction and Use Specifications)



BMP: Permanent Culvert Crossing Design
(Cofferdam Construction and Use Specifications)



FIGURE 197. Flex pipe stream diversion around a road construction site. The inlet to this 6 inch diameter flex pipe inlet collects clear streamflow from a retention dam above the project site and gravity feeds it around the project area and back into the natural channel downstream from construction work (see photo).



FIGURE 198. Sand bag retention dam on this small stream was used to pond streamflow so it could be pumped around a culvert installation site. The green intake hose is screened to keep out rocks and debris while the red pump hose extends several hundred feet around the project work area.



FIGURE 199. For larger streams, pump trucks, large pumps or multiple small pumps can be used to pump streamflow around project work sites. Here, a pump truck is used to temporarily divert flow in a fish bearing stream where dual culverts are being replaced with a railcar bridge. Young fish were removed from this fish bearing stream before project work started.

BMP: Permanent Culvert Crossing Design (Culvert Orientation)

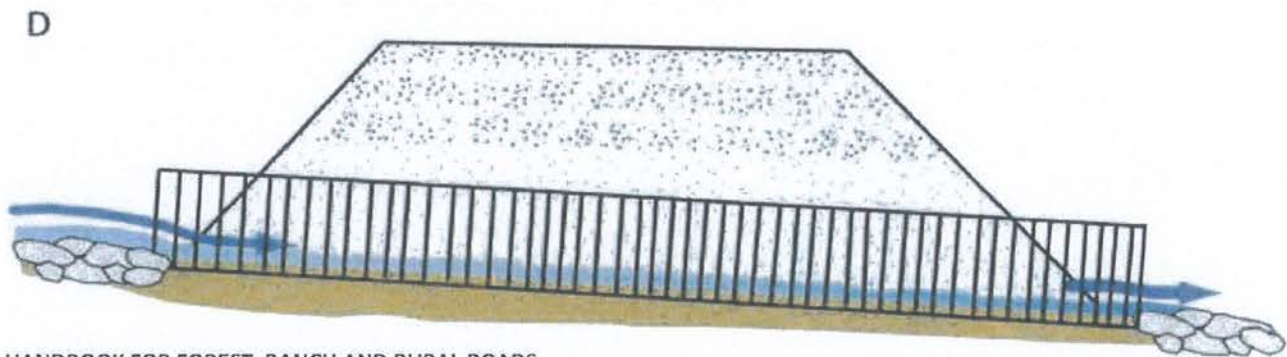
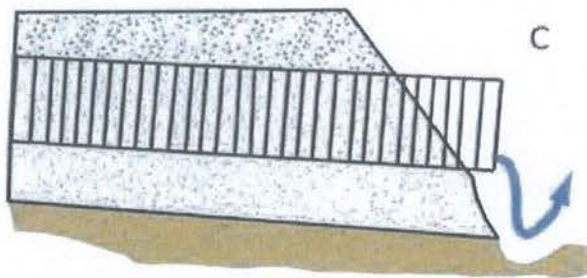
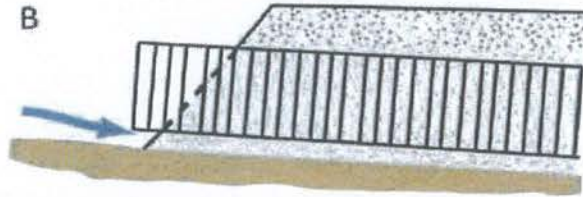
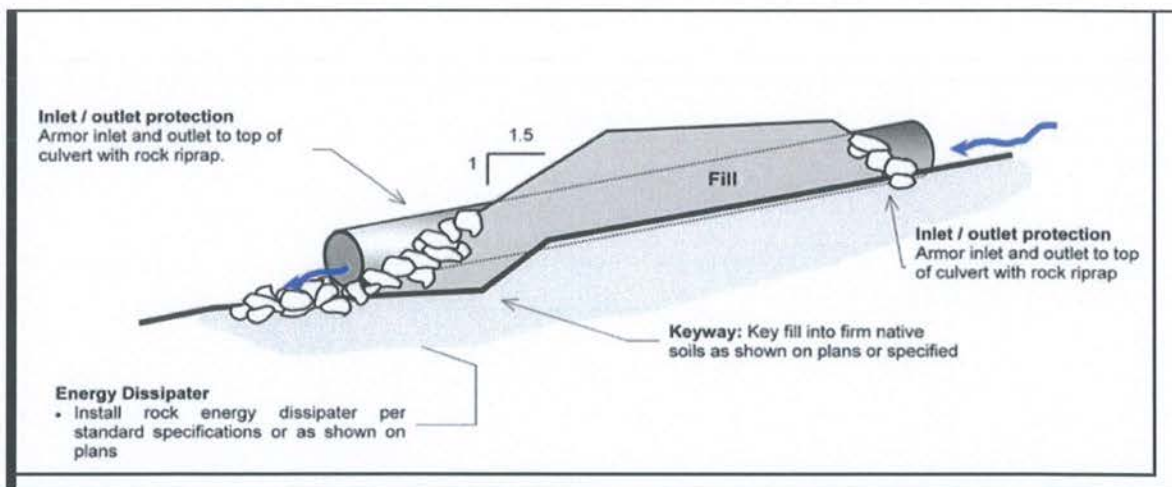
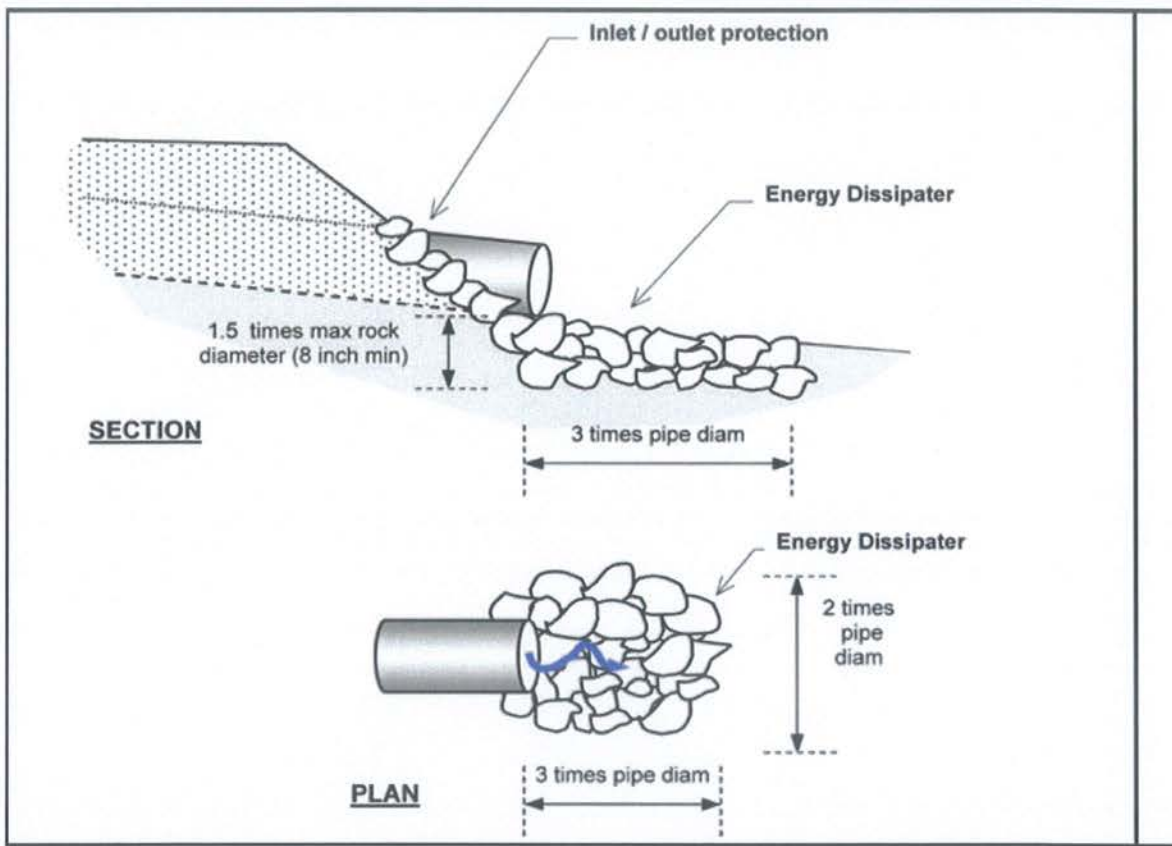


FIGURE 155. Proper culvert installation involves correct culvert orientation, setting the pipe slightly below the bed of the original stream, and backfilling and compacting the fill as it is placed over the culvert. Installing the inlet too low in the stream (A) can lead to culvert plugging, yet if set too high (B) flow can undercut the inlet. If the culvert is placed too high in the fill (C), flow at the outfall will erode the fill. Placed correctly (D), the culvert is set slightly below the original stream grade and protected with armor at the inlet and outlet. Culverts installed in fish-bearing stream channels must be inset into the streambed sufficiently (>25% embedded) to have a natural gravel bottom throughout the culvert (Modified from: MDSL, 1991).

BMP: Permanent Culvert Crossing Design (Inlet and Outlet Armoring)



Riprap installed to protect the inlet and outlet of a stream crossing culvert from erosion or for energy dissipation should be keyed into the natural channel bed and banks to an approximate depth of about 1.5x the maximum rock thickness. Riprap should be placed at least up to the top of the culvert at both the inlet and outlet to protect them from splash erosion and to trap any sediment eroded from the newly constructed fill slope above.

BMP: Permanent Culvert Crossing Design (Inlet and Outlet Armoring) Cont.

- Inlets of culverts and associate fills shall be protected with rock armoring that extends at least as high as the top of the culvert.
- Outlets of culverts shall be provided a rocked energy dissipater at the outfall of the culvert.
- Outlets of culverts and associate fills shall be protected with rock armoring that extends at least as high as the top of the culvert if road fill sloughing into channel can occur.
- Prior to inlet and outlet rocking, the inlet and outlets shall be prepared. Preparation will include removal of vegetation and stored materials from the inlet and outlet.
- Inlets may require construction of an inlet basin.
- Slopes at the outlet should be shaped to a 2:1 or natural slope prior to placing rock armor.
- Rock used at culvert inlets and outlets should be a matrix of various sized rocks and rip-rap that range from a 3" dia. to a 2' dia.
- The largest rocks should be places at the base of the culvert or fill. Incrementally smaller rocks shall be placed over the larger rocks at the armoring extend up the slope. Voids and spaces shall be back filled with smaller gravels and rocks.

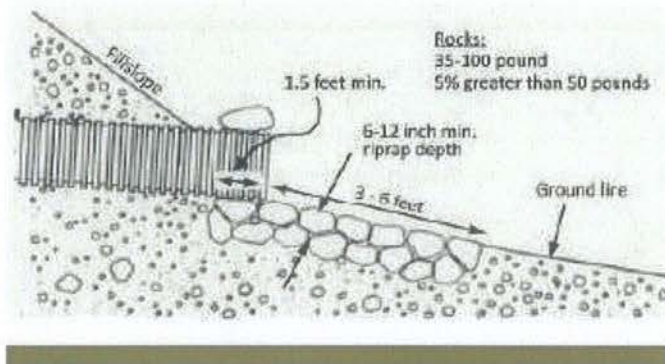


FIGURE 107A. Riprap armor at culvert outlet (Modified from: Keller et al., 2011).

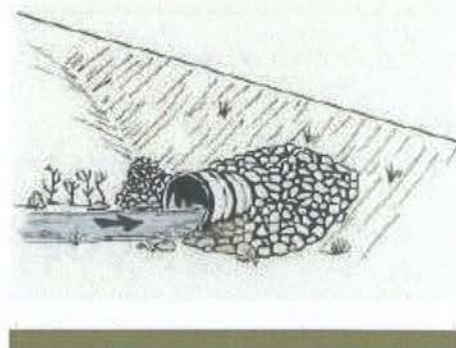


FIGURE 107B. Riprap armor at culvert inlet (Keller and Sherar, 2003).

HANDBOOK FOR FOREST, RANCH AND RURAL ROADS

BMP: Stream Bank Armoring (Riprap)

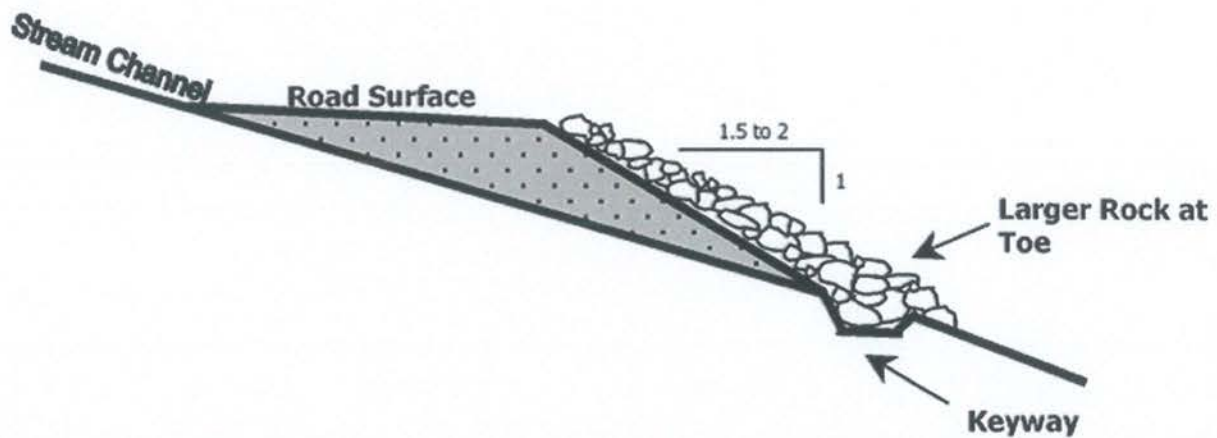
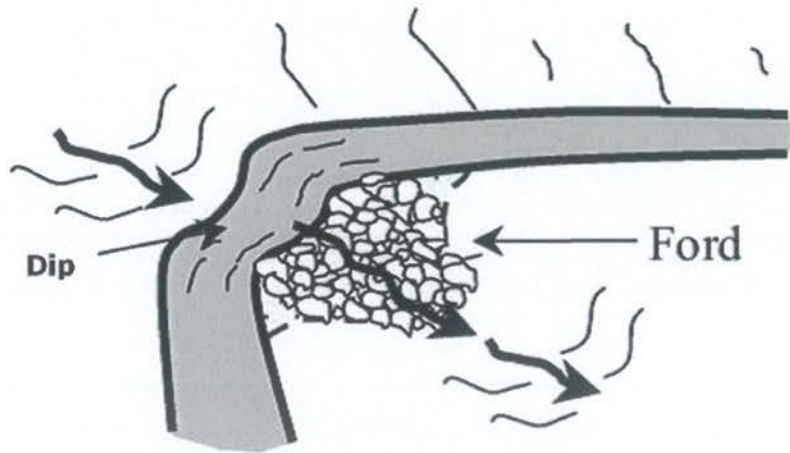
- Riprap should be installed on top of geotextile fabric or a clean mixture of coarse gravel and sand.
- The riprap should be keyed into the streambed and extend below the maximum expected scour depth with an adequately sized key base width at a thickness of a minimum of 2x the median (D50) rock diameter with the largest stone sizes placed at the base of the riprap structure.
- The armor should be set into the streambank so it does not significantly protrude into, or constrict, the natural channel, or otherwise reduce channel capacity.
- The riprap should extend along the length of unstable or over steepened bank and up the bank sufficiently to encompass the existing bank instability and/or design flood elevations.

BMP: Rocked Ford

- Rocked fords are drainage structures designed to carry watercourses across roads where culvert crossings are not feasible or un-necessary.
- In channel constructed fords shall be of appropriate material that shall withstand erosion by expected velocities and placed in a U-shaped channel to create a drivable crossing.
 - The road shall dip into and out of the rocked ford to minimize diversion potential. Construct a broad rolling dip across the roadbed, centered at the crossing, which is large enough to contain the expected 100-yr flood discharge while preventing flood flow from diverting down the road or around the rock armor.
- The road surface at the ford shall be constructed with clean rock. The rock shall be applied to a minimum depth of 6 inches.
 - A range of interlocking rock armor sizes should be selected and sized so that peak flows will not pluck or transport the armor off the roadbed or the sloping fill face of the armored fill.
- The ford's outlet shall be rock armored to resist downcutting and erosion.
 - *Excavate the keyway and armored area* - Excavate a two to three-foot-deep "bed" into the dipped road surface and adjacent fillslope (to place the rock in) that extends from approximately the middle of the road, across the outer half of the road, and down the outboard road fill to where the base of the fill meets the natural channel. At the base of the fill, excavate a keyway trench extending across the channel bed.
 - *Armor the basal keyway* - Put aside the largest rock armoring to create the buttresses. Use the largest rock armor to fill the basal trench and create a buttress at the base of the fill. This should have a "U" shape to it and it will define the outlet where flow leaves the armored fill and enters the natural channel.
 - *Armor the fill* - Backfill the fill face with the remaining rock armor making sure the final armor is unsorted and well placed, the armor is two coarse-rock layers in thickness, and the armored area on the fill face also has a "U" shape that will accommodate the largest expected flow.
 - *Armor the top of the fill* - Install a second trenched buttress for large rock at the break-in-slope between the outboard road edge and the top of the fill face.
- If water is expected during the time of use, an adequately sized pipe shall be installed to handle the flow if present (min. 6 inch).
 - The pipe shall be laid over the rocked ford surface.
 - The inlet should be at grade with the upstream flow.
 - The outlet shall drain onto the outlet armoring of the rocked ford.
 - A layer of clean rock/gravel shall be installed over the pipe to establish the running surface of the truck road.
 - Following use, the temporary pipe shall be removed and the placed rock/gravel shall be graded out of the ford and used on the approaches.
 - No significant alteration to the bed and bank of the stream shall occur.
- Road approaches to rocked fords shall be rock surfaced out to the first drainage structure (i.e. waterbar) or hydrologic divide to prevent transport of sediment using rock.
- Bank and channel armoring may occur when appropriate to provide channel and bank stabilization.
- Road approach rock and rock ford armoring shall be reapplied following use as needed to maintain a permanent crossing.

BMP: Rocked Ford (Cont.)

FORD: A large dip is graded into the road at the axis of the stream channel. The outside fill face is dished out to form a spillway with large rock. On large watercourses, rock is keyed several feet into firm native soils. The road surface is rocked with 6" of minus rock .



BMP: Armored Ford [Fill]

- Armored fords are drainage structures designed to carry watercourses across roads.
- Armored fords shall have a U-shaped channel to create a drivable crossing.
 - The road shall dip into and out of the armored ford to minimize diversion potential. Construct a broad rolling dip across the roadbed, centered at the crossing, which is large enough to contain the expected 100-yr flood discharge while preventing flood flow from diverting down the road or around the rock armor.
- The road surface at the armored ford shall utilize native soils.
- The ford's inlet shall be rocked if a threat of head cutting exists.
 - *Excavate the keyway* - Excavate a one to three-foot-deep "bed" into the inboard edge of the road
 - *Armor the basal keyway* – place various sized rock in the constructed keyway to prevent head cutting. Use the largest rock armor to fill the keyway trench and create a buttress along the inboard edge of the road. This should have a "U" shape to it and it will define the inlet where flow leaves the natural channel and enters the road.
- The ford's outlet shall be rock armored to resist downcutting and erosion.
 - *Excavate the keyway and armored area* - Excavate a two to three-foot-deep "bed" into the dipped road surface and adjacent fillslope (to place the rock in) that extends from approximately the middle of the road, across the outer half of the road, and down the outboard road fill to where the base of the fill meets the natural channel. At the base of the fill, excavate a keyway trench extending across the channel bed.
 - *Armor the basal keyway* - Put aside the largest rock armoring to create the buttresses. Use the largest rock armor to fill the basal trench and create a buttress at the base of the fill. This should have a "U" shape to it and it will define the outlet where flow leaves the armored fill and enters the natural channel.
 - *Armor the fill* - Backfill the fill face with the remaining rock armor making sure the final armor is unsorted and well placed, the armor is two coarse-rock layers in thickness, and the armored area on the fill face also has a "U" shape that will accommodate the largest expected flow.
 - *Armor the top of the fill* - Install a second trenched buttress for large rock at the break-in-slope between the outboard road edge and the top of the fill face.
- If water is expected during the time of use, an adequately sized pipe shall be installed to handle the flow if present (min. 6 inch).
 - The pipe shall be laid over the armored ford surface.
 - The inlet should be at grade with the upstream flow.
 - The outlet shall drain onto the outlet armoring of the rocked ford.
 - A layer of clean native shall be installed over the pipe to establish the running surface of the truck road.
 - Following use, the temporary pipe shall be removed and the placed native soil shall be removed and drifted along the approaches.
 - No significant alteration to the bed and bank of the stream shall occur.
- Road approaches to armored fords shall be treated with seed and straw mulch out to the first drainage structure (i.e. waterbar) or hydrologic divide to prevent transport of sediment pursuant to Item 18, Section II.
- Bank and channel armoring may occur when appropriate to provide channel and bank stabilization.
- Armored ford armoring shall be reapplied following use as needed to maintain a permanent crossing.

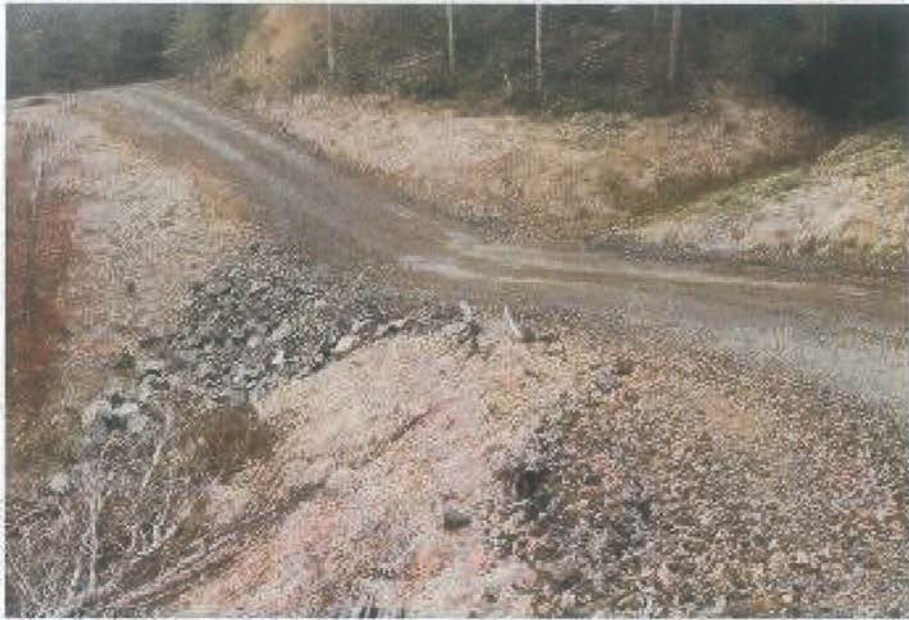
BMP: Armored Ford [Fill] (Cont.)

FIGURE 120. *This armored fill crossing of a steep, ephemeral stream was constructed to provide a low maintenance crossing. The crossing has been deeply dipped to reduce the volume of road fill and to eliminate the potential for stream diversion. The fill slope has been heavily armored through the axis of the crossing to contain flood flows and prevent down-cutting. Armored fills cannot be used on fish bearing streams.*

HANDBOOK FOR FOREST, RANCH AND RURAL ROADS

BMP: Armored Ford [Fill] (Cont.)



FIGURE 121D. Well graded rock armor is then backfilled into the structure and spread across the breadth of the U-shaped stream crossing, and about one-third the way up the roadbed, so that streamflow will only flow over or come in contact with resistant armor material. The armor must be spread and compacted across the design width of the expected flood flow channel width so peak flows will not flank the armored structure.



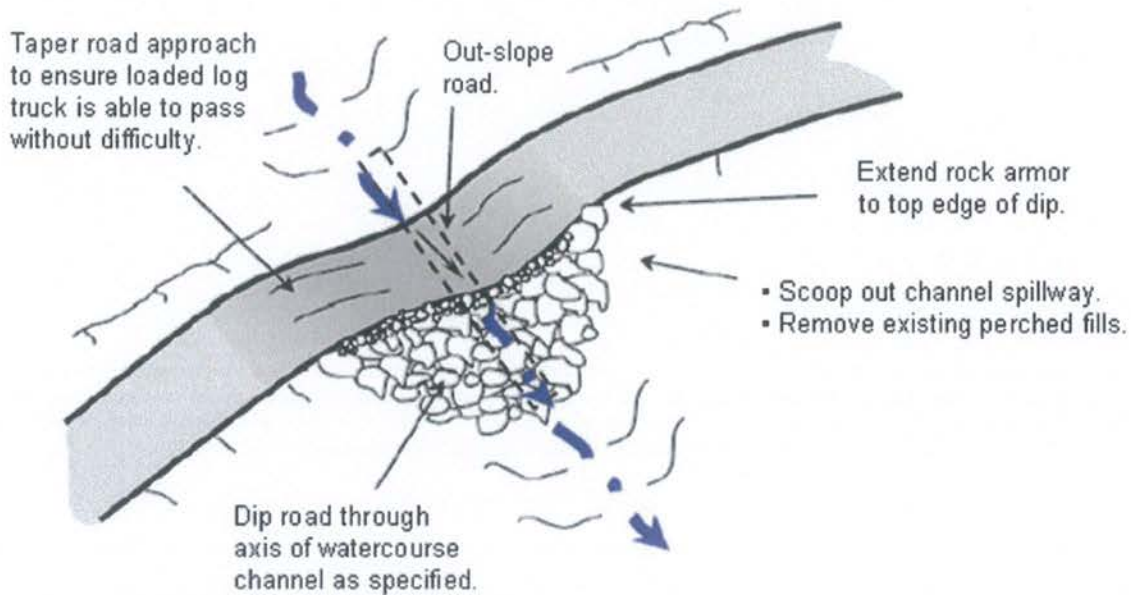
FIGURE 121E. Two weeks after this armored fill was constructed, a storm flow event occurred and the structure maintained its function and integrity. The road approaches had not yet been compacted or surfaced with road rock.



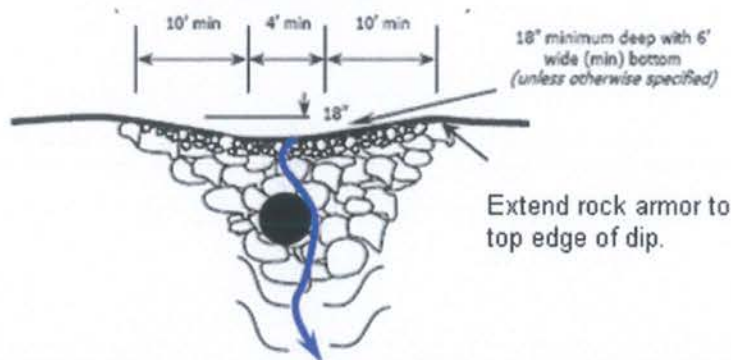
FIGURE 121F. The same armored fill as it appeared after the first winter flood flows. No maintenance was required to reopen the road. It is also clear that no stream diversion is possible at this stream crossing site, and the volume of fill within the crossing has been reduced to the minimum amount needed to maintain a relatively smooth driving surface on this low volume road.

BMP: Vented Ford

Vented Ford

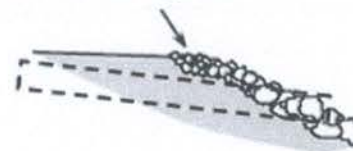


Dip area to accommodate a culvert sized for 100-year flow (minimum dimensions given below).



LIP

- Use smaller rock at lip of ford.
- Fill voids with smaller rock to prevent piping around the larger rock.



BMP: Crossing Abandonment

- Excavate and removing all fill materials placed in the stream channel when the crossing was originally built.
- Excavated banks shall be laid back to a 2:1 (50%) or natural slope to prevent slumping and soil movement.
- Fill material should be excavated to recreate the original channel grade (slope) and orientation.
- All bare soils should then be mulched, seeded, and planted to minimize erosion until vegetation can protect the soil surface.
- The approaching road segments shall be cross-road(waterbars) drained to prevent road runoff from discharging across the freshly excavated channel sideslopes.
- When fills are removed, they shall be excavated to form a channel that is as close as feasible to natural watercourse grade and orientation.
- The excavated channel bed should be as wide, or slightly wider than, the original watercourse channel.
 - This can be better determined by observing the channel width of the watercourse up slope of crossing to be removed at a point in which the crossing or any other disturbance has not affected the natural channel slope and width.
- Temporary crossings shall be removed by November 15.
 - Any temporary culvert crossing left in after October 15 or installed between October 15 and May 1, shall be sized to accommodate the estimated 100-year flow.
- In certain situations, bank and channel rock and woody debris armoring may be appropriate to provide channel and bank stabilization.

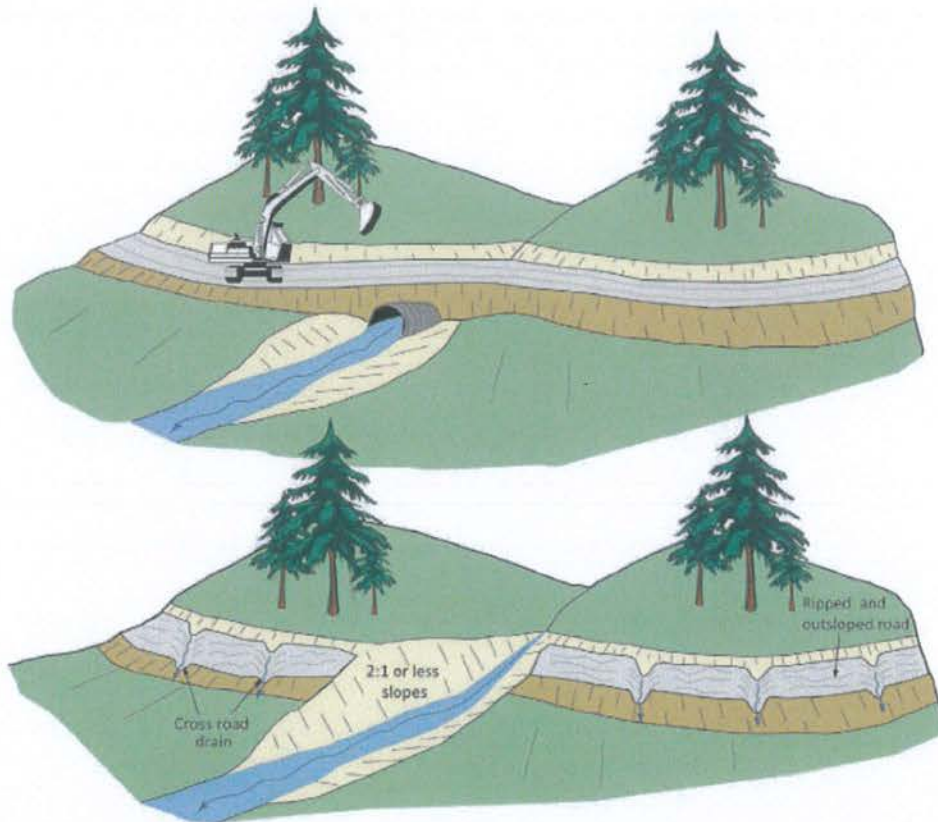


FIGURE 263. On roads that are to be closed (decommissioned), all stream crossing culverts and fills should be removed. Stream crossing excavations are best performed using an excavator. The original channel should be excavated and exhumed down to the former streambed, with a channel width equal or greater than the natural channel above and below the crossing. Sideslopes should be laid back to a stable angle, typically a 2:1 (50%) gradient, or less. Spoil can be endhailed off-site or stored on the road bench adjacent the crossing, provided it is placed and stabilized where it will not erode or fail and enter the stream.

BMP: Rolling Dip Design and Placement

- Rolling dips are drainage structures designed to force surface water to be drained from the road surface.
- The road shall dip into, and rise out of, the rolling dip to eliminate the potential of road surface runoff to run further down road way.
- The rolling dip shall be constructed with clean native materials or rock surfaced where specified.
- The rolling dips outlet may be armored to resist down-cutting and erosion of the outboard road fill.
- Do not discharge rolling dips into any areas that show signs of instability or active landsliding.
- If the rolling dip is designed to divert both road surface and ditch runoff, block the down-road ditch with compacted fill in order to force all ditch flows through the trough (low point) of the rolling dip.

BMP: Rocked Rolling Dip Design and Placement

- Rocked rolling dips are drainage structures designed to carry known sources of surface water across road ways or from known persistently wet segments of road such as swales without defined watercourses or road segments with heavy bank/road seepage.
- The road shall dip into, and rise out of, the rocked rolling dip to minimize diversion potential.
- The rocked rolling dip shall be constructed with clean rock that is large enough to remain in place during peak flows. Rock size shall vary relative to the anticipated flow through the dip with larger rock used in location where greater flow is anticipated.
- The rocked rolling dips inlet and outlet shall be armored to resist down-cutting and erosion.
- The entire width of the rocked rolling dip shall be rock armored to a minimum of 5-feet from the centerline of the dipped portion of the rolling dip.
- If a keyway is necessary, the rocked rolling dip keyway at the base of the dip shall be of sufficient size, depth and length to support materials used in the rocked rolling dip construction back up to the road crossing interface.
- Do not discharge rolling dips into any areas that show signs of instability or active landsliding.
- If the rolling dip is designed to divert both road surface and ditch runoff, block the down-road ditch with compacted fill.
- The rolling dip should be designed as a broad feature ranging from 10-100 feet long so that it is drivable by most types of vehicular traffic and not significantly inhibit traffic and road use.

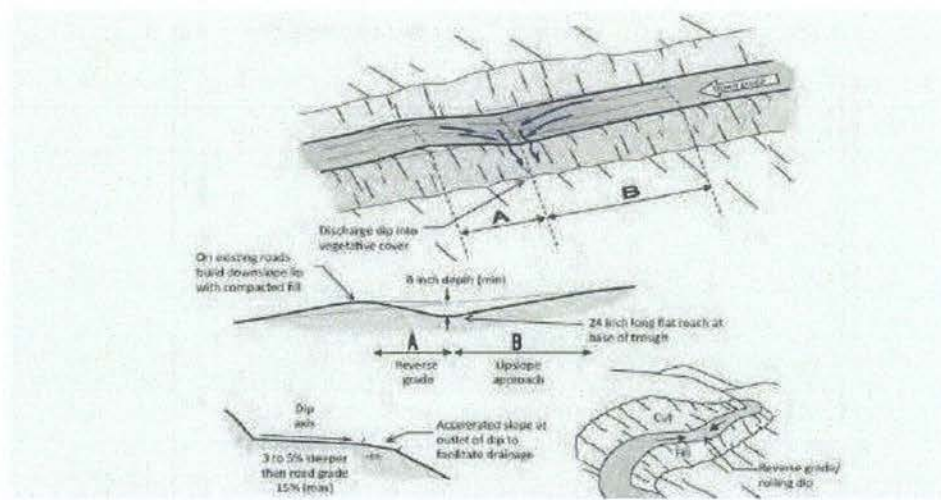
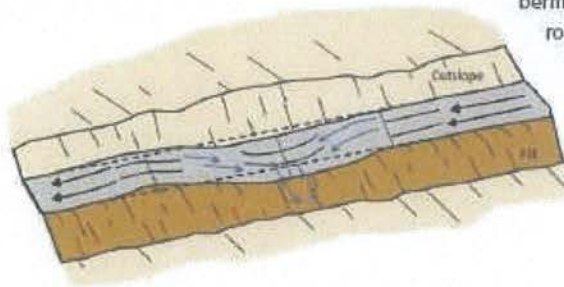


FIGURE 34. A classic Type I rolling dip, where the excavated up-road approach (B) to the rolling dip is several percent steeper than the approaching road and extends for 60 to 80 feet to the dip axis. The lower side of the structure reverses grade (A) over approximately 15 feet or more, and then falls down to rejoin the original road grade. The dip must be deep enough that it is not obliterated by normal grading, but not so deep that it is difficult to negotiate or a hazard to normal traffic. The outward cross-slope of the dip axis should be 3% to 5% greater than the up-road grade (B) so it will drain properly. The dip axis should be out-sloped sufficiently to be self-cleaning, without triggering excessive downcutting or sediment deposition in the dip axis (Modified from: Best, 2013).

HANDBOOK FOR FOREST, RANCH AND RURAL ROADS

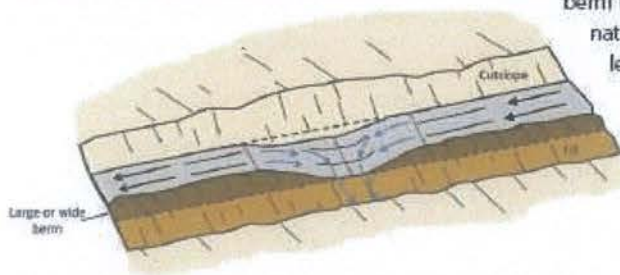
BMP: Rolling Dip Design and Placement (Types)

Type 1 Rolling Dip (Standard)



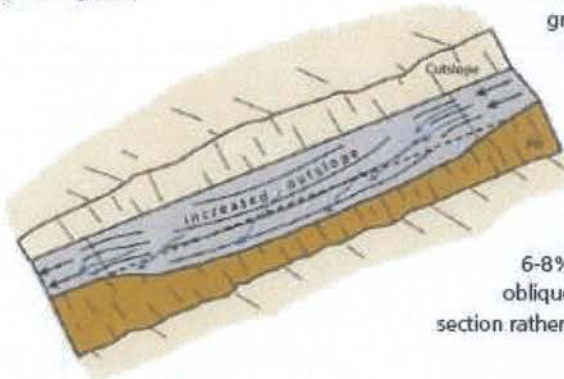
Type 1 rolling dips are used where road grades are less than about 12-14% and road runoff is not confined by a large through cut or berm. The axis of the dip should be perpendicular to the road alignment and sloped at 3-4% across the road tread. Steep roads will have longer and more abrupt dip dimensions to develop reverse grade through the dip axis. The road tread and/or the dip outlet can be rocked to protect against erosion, if needed.

Type 2 Rolling Dip (Through-cut or thick berm road reaches)



Type 2 rolling dips are constructed on roads up to 12-14% grade where there is a through cut up to 3 feet tall, or a wide or tall berm that otherwise blocks road drainage. The berm or native through cut material should be removed for the length of the dip, or at least through the axis of the dip, to the extent needed to provide for uninterrupted drainage onto the adjacent slope. The berm and slope material can be excavated and endhauled, or the material can be sidecast onto native slopes up to 45%, provided it will not enter a stream.

Type 3 Rolling Dip (Steep road grade)



Type 3 rolling dips are utilized where road grades are steeper than about 12% and it is not feasible to develop a reverse grade that will also allow passage of the design vehicle (steep road grades require more abrupt grade reversals that some vehicles may not be able to traverse without bottoming out).

Instead of relying on the dip's grade reversal to turn runoff off the roadbed, the road is built with an exaggerated outslope of 6-8% across the dip axis. Road runoff is deflected obliquely across the dip axis and is shed off the outsloped section rather than continuing down the steep road grade.

FIGURE 36. *Rolling dip types*

BMP: Rolling Dip Design and Placement

FIGURE 33A.

Rolling dip constructed on a rock surfaced rural road. The rolling dip represents a change-in-grade along the road alignment and acts to discharge water that has collected on, or is flowing down, the road surface. This road was recently converted from a high maintenance, insloped, ditched road to a low maintenance, outsloped road with rolling dips.



FIGURE 33B.

This side view of an outsloped road shows that the rolling dip does not have to be deep or abrupt to reverse road grade and effectively drain the road surface. This outsloped forest road has rolling dips that allow all traffic types to travel the route without changing speed.



BMP: Waterbar/Rolling Dip Combined with DRC



FIGURE 39.

Waterbars are often used to drain surface runoff from seasonal, unsurfaced roads. Because they are easily broken down by vehicles, waterbars are only used on unsurfaced roads where there is little or no wet weather traffic. In this photo, a waterbar and ditch relief culvert are used to drain all road surface and ditch runoff from the insloped road prism.

HANDBOOK FOR FOREST, RANCH AND RURAL ROADS

Diagram shows and discussed the use of a waterbar. However, a DRC combined with a rolling dip structure provides the same surface and ditch drainage for roads used year-round. Just as with the waterbar in the photo above, The DRC is installed just upslope from the rolling dip. This also creates a fail-safe should the DRC become plugged or overwhelmed.



FIGURE 238. *Traffic and surface runoff from graveled roads often produces surface erosion, turbid runoff and fine sediment transport that can be delivered to streams. Where ditches can't be eliminated, sediment traps and roadside settling basins can be installed to capture and remove most of the eroded sediment. This settling basin has been constructed along the inside ditch just before a stream crossing culvert inlet (see arrow). Eroded sediment from the road and ditch are deposited in the basin before flow is released to the stream. Fine sediments have filled about 1/3 of this basin and vegetation is now growing. Sediment basins require periodic maintenance to maintain their storage capacity.*

HANDBOOK FOR FOREST, RANCH AND RURAL ROADS

BMP: Road Outsloping/Insloping



HANDBOOK FOR FOREST, RANCH, AND RURAL ROADS

FIGURE 29. Road shape changes as the road travels through the landscape. For example, an outsloped road will have a steep or "banked" outslope through inside curves, a consistent outslope through straight reaches and a flat or slightly insloped shape as it goes through an outside curve. The road may have an outslope of 2-3% across the travel surface while the shoulder is more steeply outsloped to ensure runoff and sediment will leave the roadbed.

BMP: Steep Road Drainage Features

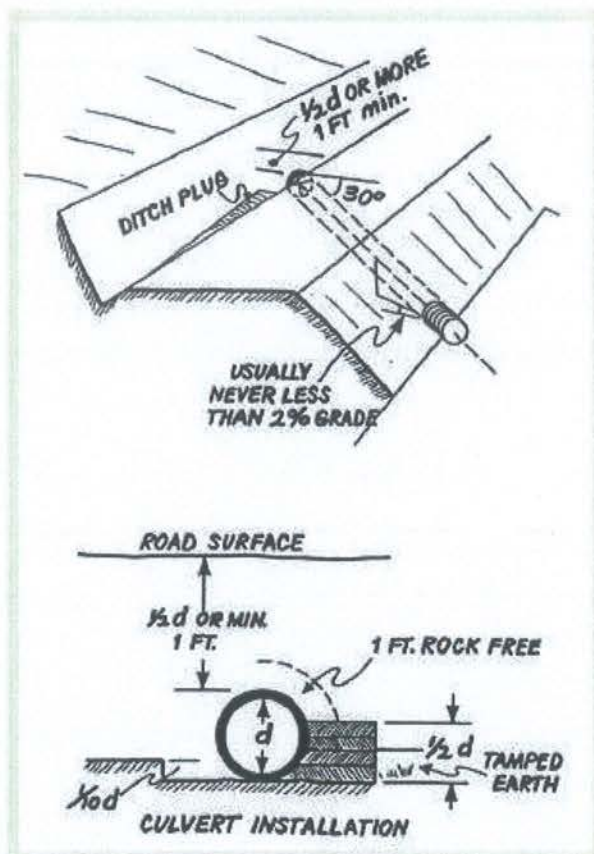


FIGURE 55. Steep roads that go straight up or down a hillside are very difficult to drain. This steep, fall line road developed a through cut cross section that was drained using lead out ditches to direct runoff off the road and onto the adjacent, vegetated hillside. The road was "outsloped" to drain runoff to the right side, and the lead out ditch was built slightly steeper than the road grade, to be self-cleaning. Four lead out ditches have been constructed at 100-foot intervals to the bottom of the hillside.

HANDBOOK FOR FOREST, RANCH AND RURAL ROADS

BMP: Ditch Relief Culvert

- Install ditch relief culverts at an oblique (typically 30 degree) angle to the road so that ditch flow does not have to make a sharp angle turn to enter the pipe. On low gradient roads (<5%), where ditch flow is slow, ditch relief culverts can be installed at right angles to the road.
- Install ditch relief culverts (DRC) to outlet at, and drain to, the base of the fill
- If it cannot be installed at the base of the fill, install the DRC with a grade steeper than the inboard ditch draining to the culvert inlet, and then install a downspout on the outlet to carry the culverted flow to the base of the fillslope or energy dissipater material at outlet to prevent erosion or the outboard road fill.
- Downspouts longer than 20 feet should be secured to the hillslope for stability.
- Ditch relief culverts should not carry excessive flow such that gulying occurs below the culvert outlet or such that erosion and down-cutting of the inboard ditch is occurring.
- Do not discharge flows from ditch relief culverts onto unstable areas or highly erodible hillslopes.
- If the ditch is on an insloped or crowned road, consider reshaping road outsloping to drain the road surface. The ditch and the ditch relief culvert would then convey only spring flow from the cutbank and hillslope runoff, and not turbid runoff from the road surface.



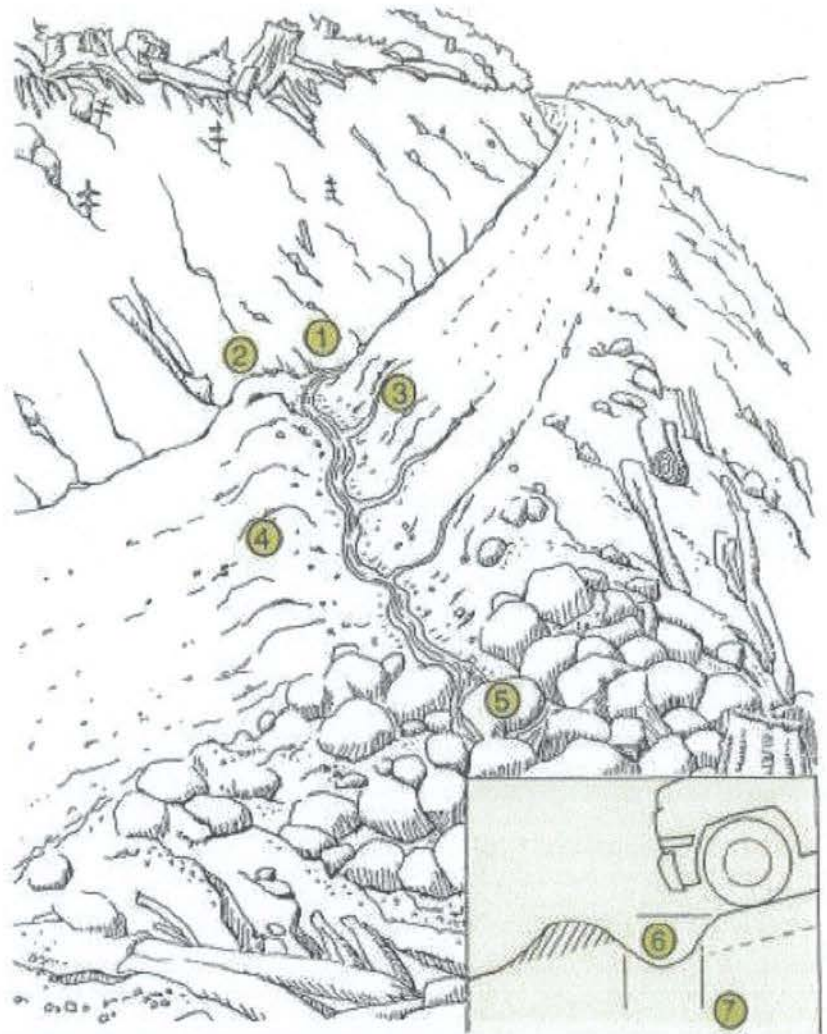
HANDBOOK FOR FOREST, RANCH AND RURAL ROADS

FIGURE 48. The elements of a properly installed ditch relief culvert. The culvert is angled at about 30 degrees to the road alignment to help capture flow and prevent culvert plugging or erosion of the inlet area. It is set at the base of the fill (ideally) or with a grade slightly steeper than the grade of the contributing ditch (but never with a grade less than 2 percent) (USDA-SCS, 1983). At a minimum, the grade of the ditch relief culvert should be sufficient to prevent sediment accumulation at the inlet or deposition within the culvert itself (it should be self-cleaning) (USDA-SCS, 1983).

BMP: Waterbar Construction

FIGURE 40. Waterbars are constructed on unsurfaced forest and ranch roads that will have little or no traffic during the wet season. The waterbar should be extended to the cutbank to intercept all ditch flow (1) and extend beyond the shoulder of the road. A berm (2) must block and prevent ditch flow from continuing down the road during flood flows. The excavated waterbar (3) should be constructed to be self-cleaning, typically with a 30° skew to the road alignment with the excavated material bermed on the downhill grade of the road (4). Water should always be discharged onto the downhill side on a stable slope protected by vegetation. Rock (shown in the figure) should not be necessary if waterbars are spaced close enough to prevent serious erosion. (5) The cross ditch depth (6) and width (7) must allow vehicle cross-over without destroying the function of the drain. Several alternate types of waterbars are possible, including one that drains only the road surface (not the ditch), and one that drains the road surface into the inside ditch (BCMF, 1991).

HANDBOOK FOR FOREST, RANCH, AND RURAL ROADS

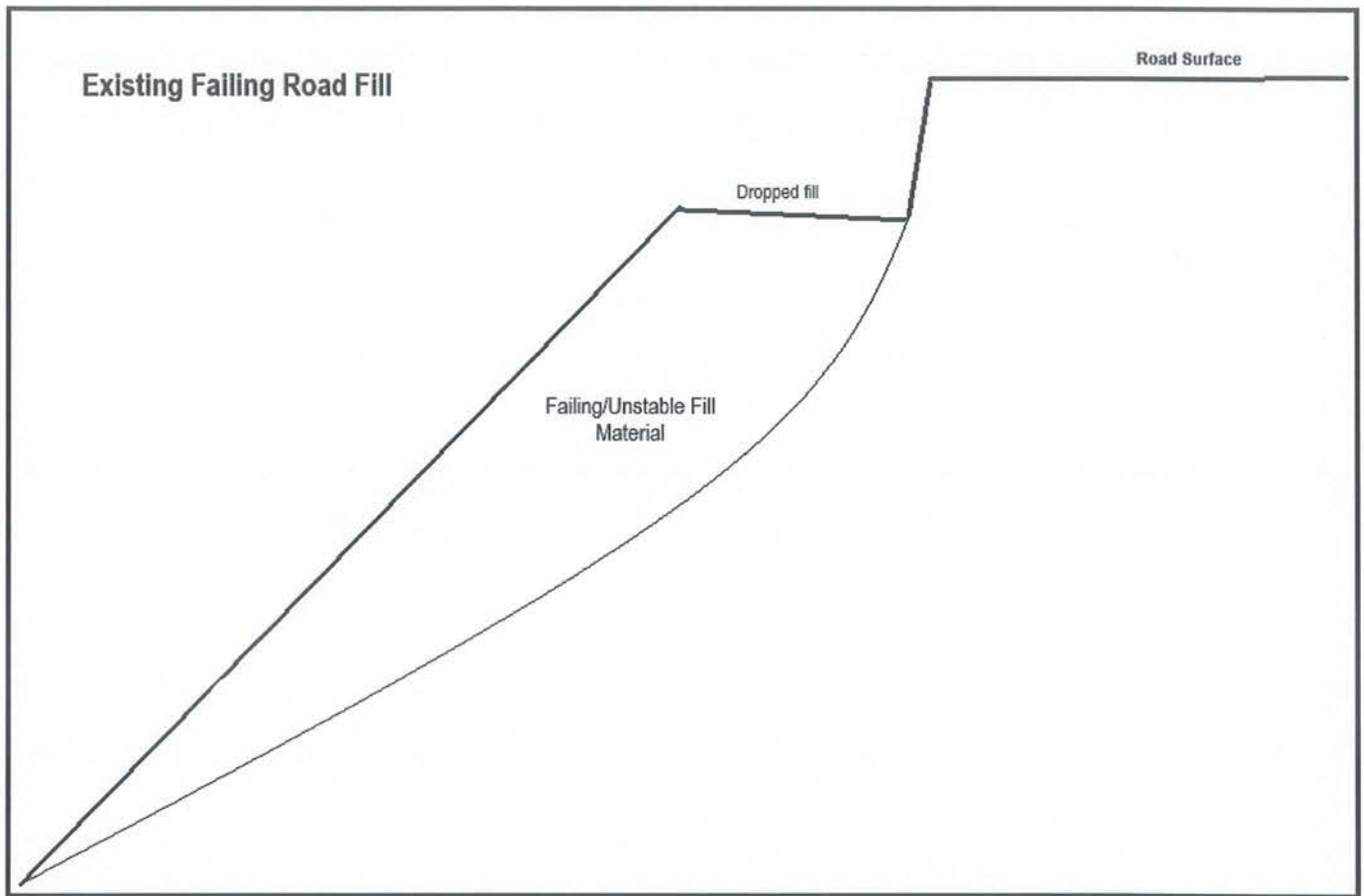


BMP: Unstable Fill Removal and Treatment

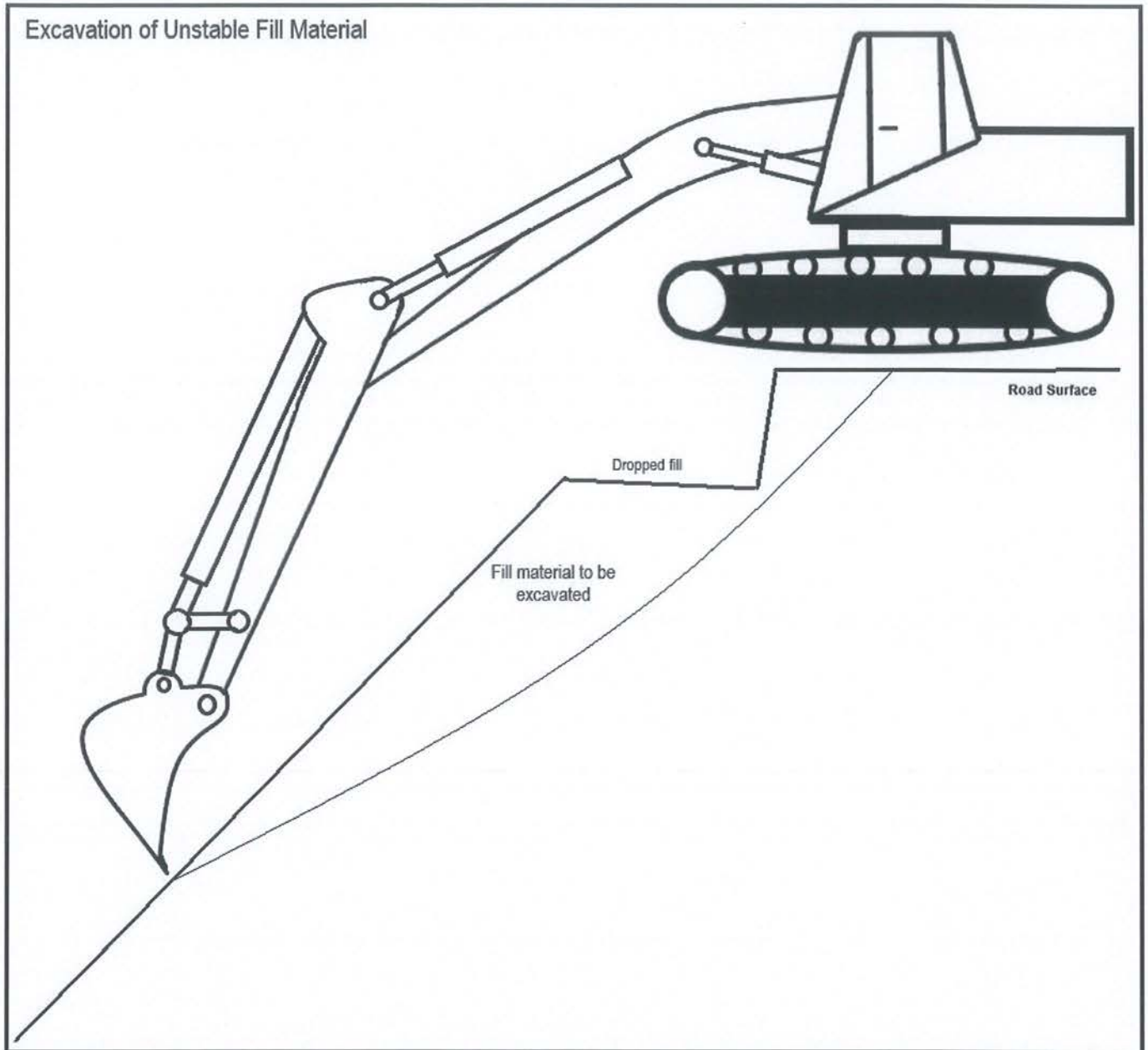


FIGURE 230. *The most cost-effective treatment for unstable fills along the outside of a forest, ranch or rural road is simply the direct excavation of the unstable material. If road width is too narrow, additional width can often be derived from cutting into the bank. The excavation should encompass the unstable fill materials, beginning at the inside crack or scarp, and extending out and down the fill slope as far as possible. For proper surface drainage, and to retrieve most of the unstable fill, the excavation should have a concave profile when completed. Typically, the bulk of the fill is within 20 to 25 feet of the outside edge of the road and is easily reached by a mid-sized excavator. Any remaining fill is likely to be small enough that it will not fail or travel far enough to reach the stream.*

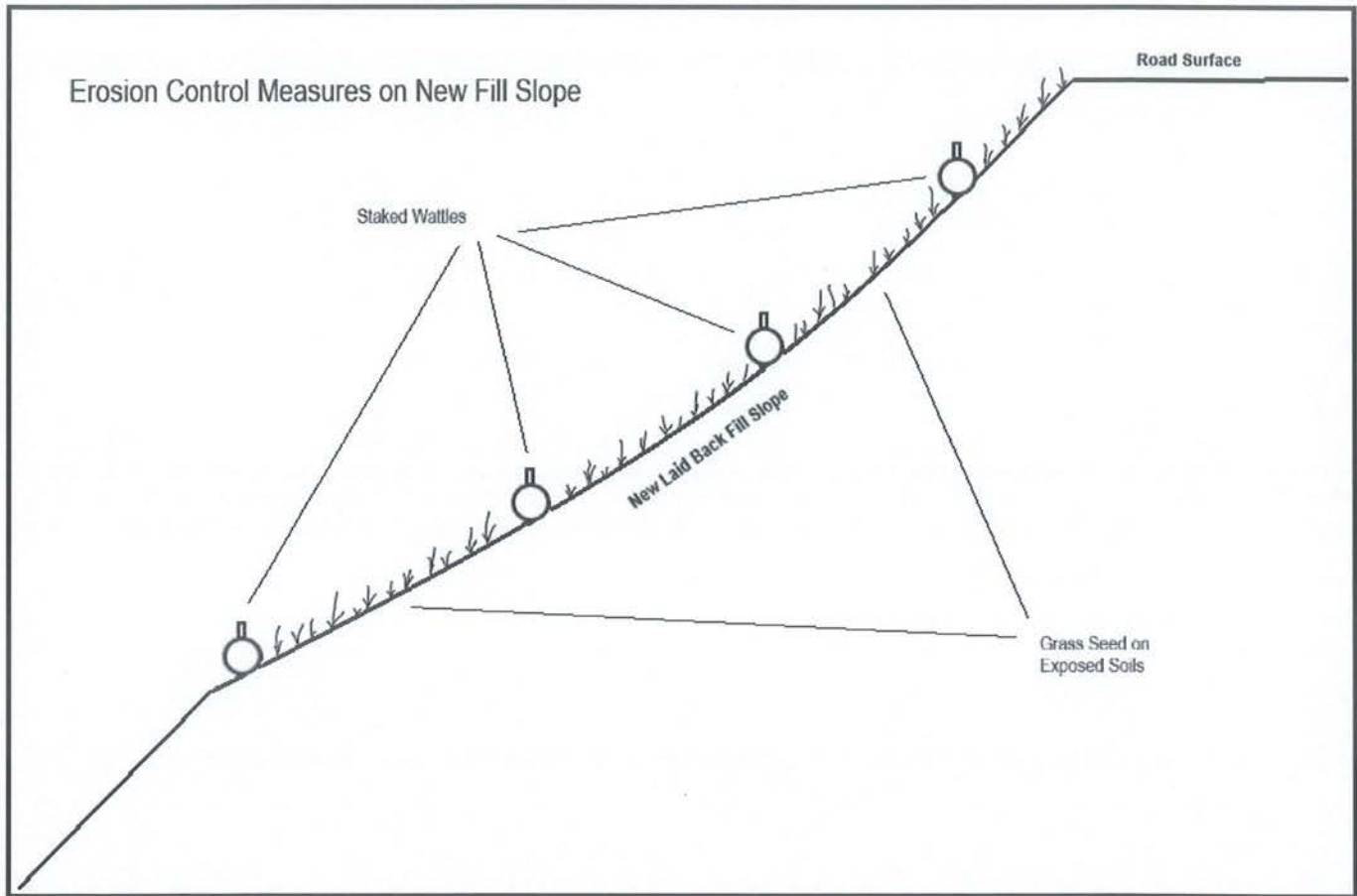
BMP: Unstable Fill Removal and Treatment



BMP: Unstable Fill Removal and Treatment



BMP: Unstable Fill Removal and Treatment



BMP: Rock Armor Cutbank



FIGURE 52. This wet and potentially unstable cut slope on a newly constructed road was stabilized using a buttress of large rock armor. To assure their effectiveness, rock buttresses and other retaining structures should be designed by a qualified engineer or engineering geologist.

HANDBOOK FOR FOREST, RANCH AND RURAL ROADS

BMP: Rip-Rap Size Class Table

TABLE 25. Standard classification and gradation of riprap by size of rock¹

Riprap size class	Median particle weight ²	Median particle diameter ² (in)	Minimum and maximum allowable particle size (in) ²							
			D ₁₅		D ₅₀		D ₉₅		D ₁₀₀	
			Min	Max	Min	Max	Min	Max	Max	
Class I	20 lb	6	3.7	5.2	5.7	6.9	7.8	9.2	12.0	
Class II	60 lb	9	5.5	7.8	8.5	10.5	11.5	14.0	18.0	
Class III	150 lb	12	7.3	10.5	11.5	14.0	15.5	18.5	24.0	
Class IV	300 lb	15	9.2	13.0	14.5	17.5	19.5	23.0	30.0	
Class V	¼ ton	18	11.0	15.5	17.0	20.5	23.5	27.5	36.0	
Class VI	3/8 ton	21	13.0	18.5	20.0	24.0	27.5	32.5	42.0	
Class VII	½ ton	24	14.5	21.0	23.0	27.5	31.0	37.0	48.0	
Class VIII	1 ton	30	18.5	26.0	28.5	34.5	39.0	46.0	60.0	
Class IX	2 ton	36	22.0	31.5	34.0	41.5	47.0	55.5	72.0	
Class X	3 ton	42	25.5	36.5	40.0	48.5	54.5	64.5	84.0	

¹Lagasse et al. (2006)

²Equivalent to spherical diameter

BMP: Storage Bladders

- Storage bladders shall be located and designed to minimize the potential for impacts due to rolling and/or failure. Storage bladders should be stored on flat slopes where stability will not be affected.
- Storage bladders shall be located to minimize the potential for water to flow into a watercourse in the event of a catastrophic failure.
- Bladders shall not be used unless the bladder is safely contained within a secondary containment system with sufficient capacity to capture 110 percent of a bladders maximum volume in the vent of bladder failure.
- Secondary containment is recommended in the form of a dirt berm, containment pit, combination of both, or impermeable material with skeletal support. The containment should be capable of holding 110 percent of the bladders volume.
- Secondary containment systems shall be of sufficient strength and stability to withstand the forces of released contents in the event of catastrophic bladder failure.
- Secondary containment systems that are exposed to precipitation shall be designed and maintained with sufficient capacity to accommodate precipitation and storm water inputs from a 25-year, 24-hour storm event.
- Bladders and containment systems shall be periodically inspected to ensure integrity.



This is an example of a containment pit which will assist in mitigating the impacts if this storage bladder failed.

BMP: Cultivation Site Restoration

- Remove all cultivation and associated materials from designated cultivation site.
 - This includes plant mass, root balls, potting containers, cultivation medium and any materials associated with the preparation, cultivation, and harvest of commercial cannabis.
 - Cultivation medium removed from the site shall be stored/disposed of in compliance with Order conditions related to spoils management.
- All disturbed and/or unstable slopes shall be stabilized and returned to pre-project conditions.
 - Slopes shall be contoured as close as feasible to natural grade and aspect.
 - Temporary erosion control shall be applied to prevent sediment run-off.
- Soil exposed as a result of project work, soil above rock riprap, and interstitial spaces between rocks shall be revegetated with native species by live planting, seed casting, or hydroseeding prior to the rainy season of the year work is completed.
 - Native plants characteristic of the local habitat shall be used for revegetation when implementing and maintaining cleanup/restoration work in riparian and other sensitive areas.
 - Native forbes and graminoids shall be planted to replace sediment stabilization, sediment filtration and nutrient filtration
 - Native trees and shrubs shall be planted to replace bank stabilization, inputs of large woody debris and temperature control within riparian areas.
 - Restoration of the quality/health of the riparian stand shall promote: 1) shade and microclimate controls; 2) delivery of wood to channels, 3) slope stability and erosion control, 4) ground cover, and 5) removal of excess nutrients.

Monitoring Plan

Cannabis cultivators shall regularly inspect and maintain the condition of access roads, access road drainage features, and watercourse crossings. At a minimum, cannabis cultivators shall perform inspections prior to the onset of fall and winter precipitation and following storm events that produce at least 0.5 in/day or 1.0 inch/7 days of precipitation. See Required Monitoring tables below for site specific monitoring and reporting requirements. Cannabis cultivators are required to perform all of the following maintenance:

- Remove any wood debris that may restrict flow in a culvert.
- Remove sediment that impacts access road or drainage feature performance.
- Place any removed sediment in a location outside the riparian setbacks and stabilize the sediment.
- Maintain records of access road and drainage feature maintenance for annual reporting.

Cannabis cultivators that are operating in areas that are, or may become, inaccessible during winter months due to extreme weather such as snow, road closures, seasonal access roads to the property, or any other such conditions shall make additional efforts to enhance winterization measures in the absence of monitoring during storm events.

Monitoring Requirements

(Tier 2, High Risk, < 1 acre of cultivation)

Monitoring Requirement	Description
Winterization Measures Implemented	Report winterization procedures implemented, any outstanding measures, and the schedule for completion.
Tier Status Confirmation	Report any changes in the tier status.
Third Party Identification	Report any change in third party status as appropriate.
Nitrogen Application*	Report monthly and annual total nitrogen use for bulk, solid, and liquid forms of nitrogen. Provide the data as lbs./canopy acre/time (month or year) as described in Attachment D, Nitrogen Management Plan. If plant tissue was collected to determine limited nitrogen availability, the results shall be submitted.
Surface Water Runoff	Report any conditions of surface water runoff, including location, duration, source of runoff (irrigation water, storm water, etc.)

Soil Erosion Control	Report any indications of soil erosion (e.g. gully, turbid water discharge, landslide, etc.)
Sediment Capture	Report the status of sediment capture measures (e.g. silt fence, fiber rolls, settling basin, etc.)
Erosion/Sediment Capture Maintenance	Report maintenance activities to maintain the effectiveness of erosion control and sediment capture measures (e.g. reinstallation of straw mulch, hydroseeding, tarp placement, removal or stabilization of sediment captured, removal of settled sediment in a basin, etc.)
Stabilization of Disturbed Areas	Dischargers characterized as high risk (with any portion of the disturbed area within the riparian setbacks), shall provide a status report describing activities performed to stabilize the disturbed area within the setback
Material(s) Storage Erosion/Spills Prevention	Report materials delivered or stored at the site that could degrade water quality if discharged off-site (e.g. potting soil, manure, chemical fertilizer, gasoline, herbicides, pesticides, etc.)
Holding Tank, Septic Tank, or Chemical Toilet Servicing	Septic tank, or chemical toilet servicing report the dates, activity, and name of the servicing company for servicing holding tanks or chemical toilets

* Nitrogen Application reporting is required when the cultivation area or aggregate of cultivation areas exceeds one acre

Please note the following information for the table below:

1. Constituents shall be monitored with a calibrated instrument.
2. Samples shall be representative of storm water discharging from the disturbed area.
3. Monitoring shall be performed during all months in which activity is occurring at the site until winterization is complete. Monitoring is not required after winterization is complete for unoccupied sites during the winter months.

The following monitoring and reporting activities are required on a monthly basis for **ALL MONTHS** until winterization procedures are completed:

Constituent	Frequency
Turbidity	Once per calendar month when precipitation exceeds 0.25 in/day or when storm water runoff from the site is generated
pH	Once per calendar month when precipitation amount is forecast to exceed 0.25 in/day

Annual Reporting

Annual Reports shall be submitted to the North Coast Regional Water Quality Control Board by March 1st following the year being monitored. Annual Reporting for this enrollment shall be submitted by March 1st, 2021 and report on monitoring done during the 2020 calendar year. Annual reporting is required each subsequent year of enrollment.

Attachments

Implementation of Applicable BPTC Measures

Assessment of applicable BPTC measures consisted of a field examination on April 3rd, 9th, and 18th, 2019. Anywhere applicable BPTC measures are not met on the property, descriptions of the assessments and the prescribed treatments are outlined following each associated section below.

Summary of BPTC Measures Compliance

1. Sediment Discharge BPTC Measures Y/N
2. Fertilizer, Pesticide, Herbicide, and Rodenticide BPTC Measures Y/N
3. Petroleum Product BPTC Measures Y/N
4. Trash/Refuse, and Domestic Wastewater BPTC Measures Y/N
5. Winterization BPTC Measures Y/N

1. Sediment Discharge BPTC Measures

1.1. Site Characteristics

- 1.1.1. Provide a map showing access roads, vehicle parking areas, streams, stream crossings, cultivation site(s), disturbed areas, buildings, and other relevant site features.

See attached Site Map.

- 1.1.2. Describe the access road conditions including estimating vehicle traffic, road surface (e.g., paved, rocked, or bare ground), and maintenance activities. Describe how storm water is drained from the access road (e.g., crowned, out slope, armored ditch, culverts, rolling dips, etc.).

The access road on the property is a permanent use road that has a locking gate at the entrance. The road is generally well constructed, with a low native rock component and high imported rock component and, based on observations of surface erosion relative to current surface drainage break frequency, are being classified as having low erodibility. Access roads have adequate outslipping and drainage features to minimize the development of surface erosion and concentrated road surface runoff. In general, the road has enough drainage features and is shaped adequately to promote surface drainage. However, existing drainage ditch relief culverts either require replacement.

Currently, three employees utilize the access road regularly during the cultivation season. The access road is used regularly during the Winter Period as there is a year-round residence and year-round cultivation activities.

- 1.1.3. Describe any vehicle stream crossing including the type of crossing (e.g., bridge, culvert, low water, etc.).

See the section titled “Stream Crossing Installation and Maintenance” or the attached Mitigation Report and Site Maps for site specific details and treatment schedules.

- 1.1.3.1. For Region 1 Dischargers, identify, discuss, and locate on the site map any legacy waste discharge issues that exist on the property.

Multiple legacy roads were identified on the property as many roads were constructed for past timber harvest activities. The roads have either already been abandoned, or are to be abandoned following the decommissioning of watercourse crossings at Sites 12, 20, 21, 28, 30, 31, 32, 33, 45, 79, & 80.

- 1.2. Sediment Erosion Prevention and Sediment Capture (Moderate risk Tier 1 or Tier 2 Dischargers are required to submit a Site Erosion and Sediment Control Plan. Those Dischargers may refer to that plan rather than repeat it here)

- 1.2.1. Erosion Prevention BPTC Measures

- 1.2.1.1. Describe the BPTC measures that have been, or will be implemented to prevent or limit erosion. Provide an implementation schedule for BPTC measures that have not yet been implemented. Identify the erosion prevention BPTC measures on a site map.

All cultivation areas have been treated with effective erosion control measures. Only certain sites on roads and trails and the 3-acre conversion area require treatment. See the attached Mitigation Report, Site Maps, and Treatment Implementation Schedule for site specific descriptions, treatments, and the implementation schedule.

- 1.2.1.1.1. The description shall address physical BPTC measures, (e.g., placement of straw mulch, plastic covers, slope stabilization, soil binders, culvert outfall armoring, etc.) and biological BPTC measures (vegetation preservation/replacement, hydro seeding, etc.).

See sections “Land Development and Maintenance, Erosion Control, and Drainage Features” and “Riparian and Wetland Protection and Management” above, and the attached Mitigation Report and BMPs for descriptions of physical and biological BPTC measures being prescribed.

1.2.2. Sediment Control BPTC Measures

- 1.2.2.1. Describe the BPTC measures that have been, or will be implemented to capture sediment that has been eroded. Provide an implementation schedule for BPTC measures that have not yet been implemented. Identify the sediment control BPTC measures on a site map.

See sections “Land Development and Maintenance, Erosion Control, and Drainage Features” and “Riparian and Wetland Protection and Management” above, and the attached Mitigation Report and BMPs for descriptions of physical and biological BPTC measures being prescribed.

- 1.2.2.1.1. The description shall address physical BPTC measures, (e.g., placement of silt fences, fiber rolls, or settling ponds/areas, etc.) and biological BPTC measures (vegetated outfalls, hydro seeding, etc.).

See sections “Land Development and Maintenance, Erosion Control, and Drainage Features” and “Riparian and Wetland Protection and Management” above, and the attached Mitigation Report and BMPs for descriptions of physical and biological BPTC measures being prescribed.

1.2.3. Maintenance Activities - Erosion Prevention and Sediment Control

- 1.2.3.1. Describe how the erosion prevention and sediment control BPTC measures will be monitored and maintained to protect water quality.

Erosion prevention BPTC measures and all corresponding work shall be inspected prior to and in conjunction with winter monitoring, as described above under the “Monitoring Plan” to ensure proper placement, installation, and function remain intact prior to and throughout the Winter Period.

- 1.2.3.2. Describe how any captured sediment will be either stabilized in place, excavated and stabilized on-site, or removed from the site.

Captured sediment by drainage features elsewhere on the property will be allowed to stabilize and vegetate in place.

- 1.2.4. Erosion control BPTC measures: Describe the interim soil stabilization, if applicable and long-term BPTC measures implemented to prevent sediment transport at each identified disturbed area(s) and improperly constructed features.

See sections “Land Development and Maintenance, Erosion Control, and Drainage Features” and “Riparian and Wetland Protection and Management” above, and the attached Mitigation Report and BMPs for descriptions of physical and biological BPTC measures being prescribed.

2. Fertilizer, Pesticide, Herbicide, and Rodenticide BPTC Measures

2.1. Provide a summary table that identifies the products used at the site, when they are delivered to the site, how they are stored, and used at the site. If products are not consumed during the growing season, describe how they are removed from the site or stored to prevent discharge over the winter season.

See comprehensive table under 2.3

2.2. Provide a site map that locates storage locations.

See attached Site Map. Fertilizers and soil amendments are currently stored properly in a storage container west of Cultivation Area A.

2.3. Describe how bulk fertilizers and chemical concentrates are stored, mixed, applied, and how empty containers are disposed.

Fertilizer, Pesticides, and Herbicide Products used on Site

Product	Delivery and Storage	On-site usage	How removed or stored
Aurora innovation's roots organics line of products	Brought to site in spring. Stored inside the storage container adjacent to Cultivation Area A	Mixed into tank with water. It is then dripline watered to above ground beds as needed.	Stored inside the storage container adjacent to Cultivation Area A. Empty containers are disposed of at an appropriate waste disposal facility.
Monterey 70% Neem Oil	Brought to site in spring. Stored inside the storage container adjacent to Cultivation Area A	Mixed into applicator tanks with water. Sprayed onto plants.	Stored inside the storage container adjacent to Cultivation Area A. Empty containers are disposed of at an appropriate waste disposal facility.
DYNA-GRO Pure Neem Oil	Brought to site in spring. Stored inside the storage container adjacent to Cultivation Area A	Mixed into applicator tanks with water. Sprayed onto plants	Stored inside the storage container adjacent to Cultivation Area A. Empty containers are disposed of at an appropriate waste disposal facility.

2.4. Describe procedures for spill prevention and cleanup.

Pesticides and liquid fertilizer containers are stored within a storage container, within secured containers, with their lids secured after their use. The cannabis cultivator shall obtain adequate quantities of absorbent materials and ensure that they are stored at all locations where the materials above are used, stored, or mixed. Should a spill of these materials occur, absorbent materials will be applied immediately and allowed enough time to absorb as much material as possible. Following treatment, absorbent materials applied will be removed and disposed of appropriately as per the manufacturer's guidelines.

3. Petroleum Product BPTC Measures

- 3.1. Provide a summary table that identifies the products used at the site, when they are delivered to the site, how they are stored, and used at the site. If products are not consumed during the growing season, describe how they are removed from the site or stored to prevent discharge over the winter season.

See comprehensive table under 3.3.

- 3.2. Provide a site map that locates storage locations.

See attached Site Map.

- 3.3. Describe how fuels, lubricants, and other petroleum products are stored, mixed, applied, and empty containers are disposed.

Petroleum Products

Products used on site	When they are delivered to site	How they are stored and used	How removed or stored
Gasoline	Brought to site when needed throughout the year.	Stored in standard 5-gallon gasoline canisters, separately from fertilizers, in sheds and vehicles. Used to fuel equipment.	Stored in standard 5-gallon gasoline canisters, in sheds and vehicles.
Diesel	Brought to site when needed throughout the year.	Stored in steel fuel tanks with secondary containment with cover from precipitation or steel transfer tanks in truck beds. Used to fuel generators and equipment.	Stored in steel fuel tanks with secondary containment with cover from precipitation or steel transfer tanks in truck beds.
Motor oil	Brought to site when needed throughout the year.	Stored in alongside generator sheds and vehicles on the property. Used to lubricate internal combustion engines.	After oil changes, the used motor oil is stored in either the container it came in or in sealed 5-gallon buckets for later disposal at an appropriate waste disposal facility.

- 3.4. Describe procedures for spill prevention and cleanup.

Any/all liquid petroleum products and their containers shall be stored in secondary containment (e.g. plastic totes or sealed metal boxes) while being stored long term or not in immediate use, wherever these materials are used anywhere on the property. Adequate quantities of absorbent materials shall be stored at all locations where these types of materials are used and stored. Should a spill of these materials occur, absorbent materials will be applied immediately and allowed enough time to absorb as much material as possible. Following treatment, absorbent materials applied as well as any contaminated soil will be removed and disposed of appropriately for the spilled material.

4. Trash/Refuse, and Domestic Wastewater BPTC Measures

- 4.1. Describe the types of trash/refuse that will be generated at the site. Describe how the material is contained and properly disposed of.

Domestic and commercial cannabis trash and refuse will be generated at the site. The trash/refuse is stored securely in trash bags and trash bins at the cultivation areas and residence prior to disposal at an appropriate waste disposal facility.

- 4.1.1. Provide a site map that locates the trash/refuse storage locations.

Trash and refuse are stored in trash bags and trash bins at mapped cultivation areas and the houses. See attached Site Map.

- 4.2. Describe the number of employees, visitors, or residents at the site.

There are three regular employees who are at the site during the cultivation season. Additional employees are brought onto the property for short periods of time to complete projects requiring additional employees. Visitors are occasionally on site, including consultants and regulatory agencies. There is also a full-time residence on the property as well.

- 4.2.1. Describe the types of domestic wastewater generated at the site (e.g., household generated wastewater or chemical toilet).

Domestic sewage and wastewater (greywater) are generated on site.

- 4.2.2. Describe how the domestic wastewater is disposed.

- 4.2.2.1. Permitted onsite wastewater treatment system (e.g., septic tank and leach lines).

Domestic sewage is disposed via septic systems and portable chemical toilets. Greywater from seasonally used travel trailers and outdoor sinks is disposed of nearby where it is generated and allowed to infiltrate.

- 4.2.2.2. Chemical toilets or holding tank. If so, provide the name of the servicing company and the frequency of service.

Bread and Butter Portables provides and services one chemical toilet during the cultivation season. The facility is serviced every two weeks.

- 4.2.2.3. Outhouse, pit privy, or similar. Use of this alternative requires approval from the Regional Water Board Executive Officer; include the approval from the Executive Officer and any conditions imposed for use of this alternative.

None present at time of site inspection.

- 4.2.2.3.1. Provide a site map that locates any domestic wastewater treatment, storage, or disposal area.

See attached Site Map for locations of residences with attached septic systems. The outhouses are not mapped but can be found adjacent to Cultivation Area C.

5. Winterization BPTC Measures

- 5.1. Describe activities that will be performed to winterize the site and prevent discharges of waste. The description should address all the issues listed above.

See Mitigation Report and Annual Winterization Measures for prescribed general winterization measures that will be performed prior to each Winter Period, and site-specific interim measures that will be performed prior to the Winter Period until permanent, prescribed treatments can be executed.

- 5.2. Describe maintenance of all drainage or sediment capture features (e.g., drainage culverts, drainage trenches, settling ponds, etc.) to remove debris, soil blockages, and ensure adequate capacity exists.

Existing drainage structures will be maintained or repaired as feasible and necessary with hand tools during annual winterization and winter monitoring. Prescribed repair and maintenance will be executed in accordance with the Mitigation Report and Treatment Implementation Schedules.

- 5.3. Describe any revegetation activities that will occur either at the beginning or end of the precipitation season.

See attached Mitigation Report and Treatment Implementation Schedule above.

- 5.4. If any BPTC measure cannot be completed before the onset of Winter Period, contact the Regional Water Board to establish a compliance schedule.

See the attached Mitigation Report and Treatment Implementation Schedule for site descriptions, treatments, and the implementation schedule.

- 5.5. For Region 1 Dischargers, describe any activities that will be performed to address legacy waste discharge issues. Region 6 Dischargers should consult with Regional Water Board staff to confirm if any other activities in addition to BPTCs are necessary to address legacy waste discharge issues.

See attached Mitigation Report and Treatment Implementation Schedule above.

Disturbed Area Stabilization Plan

(Tier 2, High Risk)

1. Site Description

- 1.1. Describe the site (e.g., topography, vegetation, elevation, historic precipitation patterns, soil types, surface waterbodies, etc.).

See the Property Description, Project Description, General Location Map, Stream Crossing Installation and Maintenance for historic precipitation patterns, Site Maps, Overview Maps (if included), in the above pages.

- 1.2. Provide a site map that shows the location of all water bodies, the applicable setback(s), all disturbed areas within the setback(s), and the storm water runoff sampling location.

See the attached Site Map, General Location Map, Overview Maps (if included), in the above pages. Storm water runoff sampling locations shall be determined during the first winter site visit, after the first major storm when storm runoff is most apparent.

- 1.3. Describe how the area was disturbed (e.g., previously existing condition, timber harvest, grading activities, etc.) and the level of disturbance.

The Disturbed Areas within riparian setback occurs at one area on the property. At Cultivation Areas E, disturbed area and associated cannabis cultivation area is located within riparian setbacks. At Cultivation Area E, change in the natural grade occurred within the riparian setbacks of a Class II watercourse by the installation of three terraces for cultivation. Previous site conditions consisted of a grass vegetated hillslope with encroaching Doug-fir saplings.

- 1.4. Describe the native vegetation that typically exists in the disturbed area.

Cultivation Area E: Native and non-native annual grasses, and encroaching Douglas fir saplings.

2. Erosion Prevention BPTC Measures

- 2.1. Describe the BPTC measures that have been, or will be implemented to prevent or limit erosion. Provide an implementation schedule for BPTC measures that have not yet been implemented. Identify the erosion prevention BPTC measures on a site map.

No erosion associated with the Disturbed Area within riparian setbacks (Cultivation Area E) was observed. Cultivation Area E is well vegetated and surrounded by vegetated buffers. No hydrologic connection was overserved from the cultivation to the adjacent watercourse. A section of streambank located along the northeastern perimeter of the cultivation area was observed caving off into the watercourse. As an emergency measure, the cultivator removed the unstable fill and installed a rock armor revetment to stabilize the streambank.

See sections titled “Land Development and Maintenance, Erosion Control, and Drainage Features”, the section titled “Riparian and Wetland Protection and Management”, the attached Mitigation Report, BMPs, Site Maps, and Treatment Implementation Schedule for site specific descriptions and of physical BPTC measures being prescribed.

- 2.1.1. The description shall address physical BPTC measures, (e.g., placement of straw mulch, plastic covers, slope stabilization, soil binders, culvert outfall armoring, etc.) and biological BPTC measures (vegetation preservation/replacement, hydro seeding, etc.).

See section “Land Development and Maintenance, Erosion Control, and Drainage Features”, the section titled “Riparian and Wetland Protection and Management”, and the attached Mitigation Report and BMPs for descriptions and of physical BPTC measures being prescribed.

3. Sediment Control BPTC Measures

- 3.1. Describe the BPTC measures that have been, or will be, implemented to capture sediment that has been eroded. Provide an implementation schedule for BPTC measures that have not yet been implemented. Identify the sediment control BPTC measures on a site map.

See section titled “Land Development and Maintenance, Erosion Control, and Drainage Features”, the section titled “Riparian and Wetland Protection and Management”, the attached Mitigation Report, BMPs, Site Maps, and Treatment Implementation Schedule for site specific descriptions and of physical BPTC measures being prescribed.

3.1.1. The description shall address physical BPTC measures, (e.g., placement of silt fences, fiber rolls, or settling ponds/areas, etc.) and biological BPTC measures (vegetated outfalls, hydro seeding, etc.).

See sections “Land Development and Maintenance, Erosion Control, and Drainage Features” and “Riparian and Wetland Protection and Management” above, and the attached Mitigation Report and BMPs for descriptions of physical and biological BPTC measures being prescribed.

4. Maintenance Activities - Erosion Prevention and Sediment Control

4.1. Describe how the erosion prevention and sediment control BPTC measures will be monitored and maintained to protect water quality.

Erosion prevention BPTC measures and all corresponding work shall be inspected prior to and in conjunction with winter monitoring, as described above under the “Monitoring Plan” to ensure proper placement, installation, and function remain intact prior to and throughout the Winter Period.

4.2. Describe how any captured sediment will be either stabilized in place, excavated and stabilized on-site, or removed from the site.

Captured sediment by drainage features elsewhere on the property will be allowed to stabilize and vegetate in place.

5. Long Term Stabilization Measures

5.1. Describe any revegetation activities designed to provide long term stabilization, that will occur either at the beginning or end of the precipitation season.

No revegetation activities designed to provide long term stabilization are being prescribed. Removal of Cultivation Area E will only require the removal of pots placed on the terraces and the Cultivation Area will be allowed to revegetated naturally. See Section 3.1.1 above see sections “Land Development and Maintenance, Erosion Control, and Drainage Features” and “Riparian and Wetland Protection and Management” above, and the attached Mitigation Report and BMPs for descriptions of physical and biological BPTC measures being prescribed.

Photographs

Photo Dates: 4/3/2019 – 4/18/2019.



Site 11. Looking downgrade to the watercourse crossing at Site 12.



Site 20. Looking across the crossing to the north.



Site 28. Looking south at the crossing.



Site 28. Looking north at the crossing.



Site 30. Looking at the outlet.



Site 40. Example of the legacy trail from Sites 40 to 43.



Site 41. Example of the legacy trail from Sites 40 to 43.



Site 46. Outlet of the ditch relief culvert.



Site 47. Looking at the outlet of the crossing.



Site 47. Looking at the outlet of the crossing from the road. Note the short culvert and metal sheeting



Site 50. Looking upstream of the inlet.



Site 50. Looking north at Site 50. The diverted watercourse from Site 51 is draining down the inside ditch to the left.



Site 51. Class III intercepts inside ditch and primarily drains to the right side of the photograph into the inlet of the crossing at Site 50.



Site 51. Looking south to the watercourse crossing at Site 52. Some of the Class III watercourse flows are flowing to the inlet of the crossing at Site 52.



Site 52. Looking upstream of the inlet.



Site 55. Looking south at Site 55. Shows seep flows not being captured by a rocked rolling dip in the foreground.



Site 58. Looking at the inlet of the crossing.



Site 58. Looking upstream of the inlet.



Site 58. Looking upstream of the inlet. Flows go subsurface in the duff before the inlet.



Site 70. Looking south across the newly installed crossing.



3-acre Conversion Area. Looking west at the conversion area.



3-acre Conversion Area. Looking east at the conversion area.



Site 79. Looking upstream of the inlet.



Site 80. Looking at the outlet of the crossing.



Site 84. Inlet



Site 84. Outlet.