

Attachment 4: Applicant's Submitted Evidence in Support of the Required Findings

A: Cultivation and Operations Plan	2
B: Engineering Geologic Evaluation	19
C: Site Management Plan	23
D: Road Evaluation	127
E: Lake and Streambed Alteration Agreement	129



**SUNNY SLOPE RANCH, LLC  
CULTIVATION AND OPERATIONS MANUAL  
HUMBOLDT COUNTY, CA**

---

**PROPOSED MEDICAL CANNABIS  
CULTIVATION FACILITIES**

PREPARED FOR:



**Revised April 2019**

**Cultivation and Operations Manual  
For  
SUNNY SLOPE RANCH, LLC**

**Proposed Medical Cannabis Cultivation Facilities**

Lead Agency:

***Humboldt County Planning Department***

3015 H Street  
Eureka, CA 95501

Prepared By:

***NorthPoint Consulting***

517 3<sup>rd</sup> Street, Suite 6  
Eureka, California 95501

In Consultation with:

**SUNNY SLOPE RANCH, LLC**

APN: 208-112-024  
26980 State Highway 36  
Bridgeville, CA 95528

Revised April 2019

**TABLE OF CONTENTS**

1. PROJECT SUMMARY ..... 1-1

    1.1. Project Objective ..... 1-1

    1.2. Site Description..... 1-1

    1.3. Land Use ..... 1-1

    1.4. State and Local Compliance..... 1-1

2. CULTIVATION AND PROCESSING ..... 2-2

    2.1. Propagation and Initial Transplant ..... 2-2

    2.2. Mixed Light/Outdoor Cultivation Plan and Schedule ..... 2-3

    2.3. Irrigation Plan and Schedule ..... 2-4

    2.4. Harvesting, Drying, and Trimming ..... 2-4

    2.5. Processing Facility..... 2-4

    2.6. Employee Plan ..... 2-4

    2.7. Security Plan and Hours of Operation ..... 2-6

3. ENVIRONMENT ..... 3-6

    3.1. Water Source and Projected Water Use ..... 3-6

    3.2. Water Storage..... 3-7

    3.3. Site Drainage, Runoff, and Erosion Control ..... 3-7

    3.4. Watershed and Habitat Protection ..... 3-7

    3.5. Monitoring and Reporting ..... 3-7

    3.6. Energy and Generator Use ..... 3-8

    3.7. Use and Storage of Regulated Products ..... 3-8

    3.8. Waste Management Plan ..... 3-9

4. PRODUCT MANAGEMENT ..... 4-9

    4.1. Product Testing and Labeling ..... 4-9

    4.2. Product Inventory and Tracking ..... 4-10

    4.3. Transportation and Distribution ..... 4-10

APPENDICES

Appendix A: Plot Plan

Appendix B: Cultivation Activities Schedule

Appendix C: References

## 1. PROJECT SUMMARY

### 1.1. PROJECT OBJECTIVE

SUNNY SLOPE RANCH, LLC is proposing to permit existing medical cannabis cultivation activities in accordance with the County of Humboldt's (County) *Commercial Medical Marijuana Land Use Ordinance* (CMMLUO). The project requires Conditional Use Permit (CUP) for approximately 5,270 square feet (sf) of mixed light and 12,970 sf of outdoor medical cannabis cultivation. The project includes the permitting of existing and proposed facilities appurtenant to the cultivation, including greenhouses, and a cultivation facility for drying, curing, and trimming of medical cannabis. The applicant aims to become fully compliant with State and Local cultivation regulations.

### 1.2. SITE DESCRIPTION

The Project is located at 26980 State Highway 36, Bridgeville, CA 95528, (APN 208-112-024). The subject parcel is approximately 38.32 acres in size (per the County of Humboldt's WebGIS), having relatively flat topography and slopes of less than 15% gradient. The eastern half of the property is primarily forest. The western half of the property is characterized as open grasslands, and is where most of the cultivation takes place. Existing mixed light cultivation is located within greenhouses.

### 1.3. LAND USE

The subject property has a General Plan designation of Agricultural Land as identified by the Humboldt County General Plan and is zoned Forest Recreation (FR). The property contains 0 SF of prime agricultural soils according the Humboldt WebGIS. Land uses surrounding the parcel are comprised of agriculture. The surrounding parcels are zoned Timber Production Zone (TPZ) and Forest Recreation (FR).

### 1.4. STATE AND LOCAL COMPLIANCE

#### 1.4.1. STATE OF CALIFORNIA COMMERCIAL CANNABIS ACTIVITY LICENSE

SUNNY SLOPE RANCH, LLC has obtained two (2) temporary Commercial Cannabis Activity license from the State of California (Small Outdoor TML18-0013132; Small Mixed Light Tier 1 TML18-0013176). The applicant is in the processes of obtaining annual Commercial Cannabis Activity licenses.

#### 1.4.2. STATE WATER RESOURCES CONTROL BOARD

Water for domestic and cultivation uses is provided by a rainwater catchment system with storage in tanks. The applicant does have two (2) Initial Statements of Diversion and Use (ISDU) for riparian claims. The applicant only has the riparian claims for back-up purposes. Surface water will only be diverted if the rainwater catchment pond did not fill or if pond maintenance is required. In this situation, the applicant would obtain the correct permits as required.

#### 1.4.3. NORTH COAST REGIONAL WATER QUALITY CONTROL BOARD

SUNNY SLOPE RANCH, LLC has enrolled with the North Coast Regional Water Quality Control Board (NCRWQCB) for coverage under Tier 2 of Order No. 2015-0023 *Waiver of Waste Discharge Requirements and General Water Quality Certification for Discharges of Waste Resulting from Cannabis Cultivation and Associated Activities or Operations with Similar Environmental Effects in the North Coast Region* (WDID Number 1B171048CHUM). A Water Resources Protection Plan/Site Management Plan has been developed for the project by NorthPoint Consulting and is being implemented for activities associated with onsite cultivation.

Sunny Slope Ranch, LLC is in the process of transitioning to coverage under the State Water Resources Control Board General Order WQ 2017-0023-DWQ *General Waste Discharge Requirements and Waiver of Discharge Requirements for Dischargers of Waste Associated with Cannabis Cultivation Activities*. The transition will occur by July 1, 2019. Additionally, a Site Management Plan has been developed by NorthPoint Consulting and will be furnished to the North Coast Regional Water Quality Control Board within 90 days post-enrollment.

#### **1.4.4. HUMBOLDT COUNTY BUILDING DEPARTMENT**

All necessary building permits will be obtained from the Humboldt County Building Department for all existing and proposed structures and supporting infrastructure upon approval of the Conditional Use Permit.

#### **1.4.5. CAL FIRE**

The subject property is located within a State Responsibility Area (SRA) for fire protection. Several improvements are proposed in order to meet SRA requirements, including designating a fire turn-around and pull-out area for emergency vehicles, and management of trees and vegetation around existing structures to maintain the required 100-foot defensible space. All structures on the property meet the 30-foot SRA setback requirement from property lines. Additionally, the applicant has a 2,500-gallon water storage tank designated for fire protection. The applicant will also ensure that building and roads will have appropriate signing that will be visible and legible from approaching roadway.

#### **1.4.6. CALIFORNIA DEPARTMENT OF FISH AND WILDLIFE**

A Final Streambed Alteration Agreement has been issued the California Department of Fish and Wildlife (CDFW). The agreement is for the following executed encroachments: culvert replacement, pond spillways, restoration of drainages, and points of diversion (Notification No. 1600-2016-0003-R1).

#### **1.4.7. CULTURAL RESOURCES**

A cultural resources survey has been performed by Sonoma State University. If buried archaeological or historical resources are encountered during construction or cultivation activities, the applicant or contractor shall call all work in the immediate area to halt temporarily, and a qualified archaeologist is to be contacted to evaluate the materials. Prehistoric materials may include obsidian or chert flakes, tools, locally darkened midden soils, groundstone artifacts, dietary bone, and human burials. If human burial is found during construction, state law requires that the County Coroner be contacted immediately. If the remains are found to be those of a Native American, the California Native American Heritage Commission will then be contacted by the Coroner to determine appropriate treatment of the remains. The applicant is ultimately responsible for ensuring compliance with this condition.

## **2. CULTIVATION AND PROCESSING**

### **2.1. PROPAGATION AND INITIAL TRANSPLANT**

Juvenile plants are propagated on site a from nursery from seeds and 'mother plants' that demonstrate the desired genetics for the specific cannabis strain. Mother plants remain in the vegetative stage solely for propagation. Cuttings are sampled from the mother plants and are rooted into a growing medium, typically oasis cubes, to produce 'clones.' The clones are placed into the nursery, and once fully rooted they are transplanted directly into one (1) gallon pots (see Appendix A

for nursery location). The juvenile plants are irrigated using hand watering methods. After 3 weeks the clones are then transplanted into beds with a soil and perlite medium, and moved into either a mixed light greenhouse or indoor cultivation building where they continue their 'vegetative' cycle. Adult plants will be irrigated using drip emitters in the greenhouses and a combination of drip emitters and hand watering in the outdoor cultivation areas.

## 2.2. MIXED LIGHT/OUTDOOR CULTIVATION PLAN AND SCHEDULE

There is approximately 5,270 square feet (sf) of mixed light and 12,970 sf of outdoor medical cannabis cultivation. The total cultivation area is 18,240 sf, refer to site map. The applicant is proposing to relocate or rearrange existing cultivation due to stream setback and unstable slopes, refer to Table 2.1 for a summary of existing and proposed cultivation.

Map ID	Type of Cultivation	Area (sf)	To Be Relocated or Rearranged (Y/N)	Reason for Relocation or New Arrangement	Type of Cultivation After Relocation
A	Mixed Light	2,170	Y	Located within stream setbacks	Full Sun Outdoor
B	Mixed Light	2,500	Y	Located within stream setbacks	Full Sun Outdoor
C	Mixed Light	600	N	N/A	N/A
D	Outdoor in Greenhouse	2,380	N	N/A	N/A
E	Outdoor in Greenhouse	1,370	Y	20' of greenhouse are located within stream setback	Outdoor in Greenhouse
F	Full Sun Outdoor	1,250	Y	Located on unstable hillside with greater than 15% slope and in the headwall of a drainage	Full Sun Outdoor
G	Full Sun Outdoor	1,450	Y	Located on unstable hillside with moderate slope	Full Sun Outdoor
H	Full Sun Outdoor	1,000	Y	Road leading to cultivation >30% and poses high erosion	Full Sun Outdoor
I	Outdoor in Greenhouse	3,220	N	N/A	N/A

J	Full Sun Outdoor	2,000	N	N/A	N/A
---	---------------------	-------	---	-----	-----

Two greenhouses consist of heavy gauge steel tubing, covered with a woven poly translucent opaque tarp. Four greenhouses are Douglas Fir framed, with PVC tubing and fiberglass roofing. Greenhouse floors consist of unimproved floor per HCC §314-43.1.3.2. Each greenhouse is ventilated by intake and exhaust fans. The greenhouses utilize a combination of artificial light and light deprivation to produce up to two (2) flowering cycles per year for mixed light and one (1) cycle per year for outdoor cultivation. The monthly Cultivation Schedule in Appendix C details the cultivation activities associated with the mixed light cultivation operation for a typical three cycle year.

### **2.3. IRRIGATION PLAN AND SCHEDULE**

Irrigation and fertigation of plants occurs using top-feed hand watering and drip emitter methods. SUNNY SLOPE RANCH, LLC maintains that irrigation and fertigation is more efficiently managed via hand watering and drip emitters, allowing for daily inspection of each plant by the cultivator and tailored irrigation and nutrient application depending on the needs of each individual plant. The monthly Cultivation Schedule in Appendix C details the irrigation activities associated with all cultivation.

### **2.4. HARVESTING, DRYING, AND TRIMMING**

Plants that are ready for harvest have their flowering branches removed and suspended in the drying facility which is equipped with ventilation fans. The drying process takes approximately one week.

The dried flowers are then bucked into manageable buds and hand trimmed at the processing facility.

The finished product is stored in the processed materials room before being transported to a licensed distribution facility. The waste product, or 'trim', from the machines is collected and placed into bins to be weighed, labeled, and sealed. Trim will be transferred to an offsite, licensed manufacturing facility.

### **2.5. PROCESSING FACILITY**

Per the letter from the Humboldt County Health and Human Services Environmental Health Division, processing will not occur onsite until an acceptable site suitability report can establish potential for onsite waste treatment system.

Once this condition is met, all cannabis processing will occur on site at the 1,200 sf cultivation facility, and the two storage buildings that are 440 sf and 1,200 sf. The facility will incorporate all aspects of processing including drying, curing, and trimming, and will include a restroom for employees. The restroom will be ADA-compliant with a working flush toilet and an OSHA-compliant hand-washing station with soap, towels, and hot and cold running water. Employees will work at a distance typically less than 300 feet from the restroom facility. The proposed metal building will have an engineered concrete slab and will conform to commercial building standards per the 2016 California Building Code.

The processing operation will be maintained in a clean and sanitary condition. The operation will implement protocols in order to prevent processing contamination and mold and mildew growth on cannabis. Employees handling cannabis will have access to facemask and gloves.

### **2.6. EMPLOYEE PLAN**

SUNNY SLOPE RANCH, LLC is an "agricultural employer" as defined in the Alatorre-Zenovich-Dunlap-Berman Agricultural Labor Relations Act of 1975 (Part 3.5 (commencing with Section 1140) of Division



2 of the Labor Code), and complies with all applicable federal, state and local laws and regulations governing California Agricultural Employers.

#### **2.6.1. JOB DESCRIPTIONS AND EMPLOYEE SUMMARY**

- *Agent in Charge*: Responsible for business oversight and management of the SUNNY SLOPE RANCH, LLC. Responsibilities include, but are not limited to: inventory and tracking, personnel management, record keeping, budget, and liaison with State and County inspectors as needed. This is a full-time, seasonal position.
- *Lead Cultivator*: Oversight and management of the day to day cultivation of medical cannabis. Responsibilities include, but are not limited to: plant propagation and transplant, soil management, irrigation, fertilization, pesticide management, and harvest activities. This is a full-time, seasonal position.
- *Assistant Cultivator / Processing Manager*: Provides support to the *Lead Cultivator* in their day to day duties and takes the lead role during times when the *Lead Cultivator* may be off site. Once processing activities commence, the *Assistant Cultivator* duties switch to oversight and management of processing the dried medical cannabis. This is a full-time, seasonal position.
- *Seasonal Laborer*: Provides cultivation, harvesting, and processing support including hand-finish trimming. This is a full-time, seasonal position.

#### **2.6.2. STAFFING REQUIREMENTS**

In addition to the *Agent, Lead Cultivator, and Assistant Cultivator positions*, up to two (2) full-time seasonal labor positions are employed. The number of seasonal laborers varies based on the needs of the farm during the cultivation, harvest and processing seasons. During the peak harvest and processing season, there are an estimated total of five (5) employees on site.

#### **2.6.3. EMPLOYEE TRAINING AND SAFETY**

On site cultivation, harvesting, drying, and trimming is performed by employees trained on each aspect of the procedure including: cultivation and harvesting techniques and use of pruning tools; proper application and storage of pesticides and fertilizers; and correct hand trimming methods. All cultivation and processing staff are provided with proper hand, eye, body and respiratory Personal Protective Equipment (PPE). Access to the onsite cultivation, drying and processing facilities are limited to authorized and trained staff.

All employees are trained on proper safety procedure including fire safety; use of rubber gloves and respirators; proper hand washing guidelines; and protocol in the event of an emergency. Contact information for the local fire department, CAL FIRE, Humboldt County Sheriff and Poison Control as well as the Agent in Charge will be posted at the employee restroom. Each employee is provided with a written copy of emergency procedures and contact information. The material safety data sheets (MSDS) are kept on site and accessible to employees.

#### **2.6.4. TOILET AND HANDWASHING FACILITIES**

The portable toilets are currently used and the processing building will include one (1) ADA-compliant restroom, including a working flush toilet as well as a sink with hot and cold running water. Anti-bacterial Liquid Soap and paper hand towels will be made available. Employees will work at a distance typically no greater than 600 feet from the restroom facility.

#### 2.6.5. ON SITE HOUSING

The existing single-family residence located on site is occupied by the Property owner. All other full-time and seasonal employees live off site and commute daily to the cultivation site. No new residential structures are proposed as a part of this project.

#### 2.6.6. EMPLOYEE PARKING PLAN

Employees commute to the site daily and are encouraged to carpool. The Agent in Charge will park at the main residence. All other staff will have parking spots located near Structure #3, Refer to Site Plan-Sheet C3. There will be three parking spaces and one ADA parking space available.

### 2.7. SECURITY PLAN AND HOURS OF OPERATION

#### 2.7.1. FACILITY SECURITY

The cultivation facilities, including greenhouses and processing building will be enclosed in a secure privacy fence. The entry gates remain locked at all times and access to the cultivation area is limited exclusively to employees. Restricted access signs are posted conspicuously at the entry gates. The cultivation and processing facility area will have low intensity exterior lighting to illuminate the entrances and will include a small number of motion activated security lights. All lighting will be designed and located so that direct rays are confined to the property. Security cameras will be installed at the main access gates and at entrances to the facilities.

#### 2.7.2. HOURS OF OPERATION

Activities associated with cultivation in the greenhouses (watering, transplanting, and harvesting) generally occur during daylight hours. All other activities such as processing typically occur no earlier than 6 AM and extend no later than 11 PM.

#### 2.7.3. NOISE LEVELS RELATED TO PROJECT

Noise measurements will be taken utilizing a noise decibel meter. Measurements will be taken at the property lines when all cannabis related activities are not in operation. The average of these measurements will determine the ambient noise level. The same procedure will take place when cultivation is in operation. The difference in the measurements will determine the noise produced by the project. If needed noise mitigation measures will be implemented. An example of a mitigation measure would be the construction of acoustic barriers around generators.

## 3. ENVIRONMENT

### 3.1. WATER SOURCE AND PROJECTED WATER USE

See section 1.4.2 for water source.

SUNNY SLOPE RANCH, LLC utilizes water management strategies such as hand watering and drip emitters to conserve water use.

The table below outlines the estimated irrigation water usage for cultivation during a typical year. Variables such as weather conditions and specific cannabis strains will have a slight effect on water use.

Jan	Feb	Mar	April	May	June	July	Aug	Sept	Oct	Nov	Dec
0	0	0	11,750	30,000	34,250	44,250	50,000	50,000	35,000	0	0

### **3.2. WATER STORAGE**

Water storage for irrigation use is provided in existing rainwater catchment tanks and basins. The capacity of the tanks is 467,000 gallons.

### **3.3. SITE DRAINAGE, RUNOFF, AND EROSION CONTROL**

SUNNY SLOPE RANCH, LLC is enrolled with the North Coast Regional Water Quality Control Board (NCRWQCB) for Tier 2 coverage, and a Water Resources Protection Plan (WRPP) has been developed utilizing best management practices (BMP's) in accordance with the NCRWQCB's recommendations.

#### **3.3.1. SITE DRAINAGE AND RUNOFF**

The site is mostly flat with surface flow in the wet season generally draining from the northeast to the residential area to the southwest. The driveway to the main residence has been rocked. The existing and proposed greenhouses are located away from riparian zones. Fertilizers and pesticides are currently stored in a storage shed with secondary containment to prevent contamination with runoff. Sites have been identified for storage/disposal of spoils and cultivation waste.

Cultivation facilities will meet all required setbacks from the nearest water course, providing a sufficient buffer to prevent sediment and nutrient delivery. To further prevent runoff to riparian areas, water conservation and containment measures will be implemented including the use of hand irrigation to prevent excessive water use, and the maintenance of a stable, vegetated buffer between the cultivation area and riparian zone.

#### **3.3.2. EROSION CONTROL**

SUNNY SLOPE RANCH, LLC will utilize best management practices including but not limited to:

1. Maintenance of roads, including rocking and armoring.
2. Proper management of solid, liquid and cultivation waste (see section 3.8)
3. SUNNY SLOPE RANCH, LLC has secured a DFW LSAA for its culverts and stream crossings.
4. Cultivation facilities and spoil stockpiles will meet all required setbacks from riparian and wetland areas.
5. Irrigation and application of fertilizers will be applied at argonomic rates.
6. Regulated products will be safely stored with secondary containment (see section 3.7)

### **3.4. WATERSHED AND HABITAT PROTECTION**

Adherence to the proposed best management practices ensures that the watershed and surrounding habitat are protected. The cultivation activities and associated structures meet all required setbacks from the nearest watercourse, providing a suitable buffer between the cultivation operation and habitat. Additionally, site development and maintenance activities utilize BMP's in accordance with the NCRWQCB's recommendations. Any grading and earthwork activities will be conducted by a licensed contractor in accordance with approved grading permits.

### **3.5. MONITORING AND REPORTING**

Monitoring will be conducted to confirm the effectiveness of corrected measures listed in the Water Resource Protection Plan (WRPP)/Site Management Plan (SMP) and determine if the site meets all Standard Conditions. Inspections will include photographic documentation of any controllable sediment discharge sites as identified on the site map. Visual inspection will occur at those locations on the site where pollutants or wastes, if uncontained, could be transported into receiving waters, and those locations where runoff from roads or developed areas drains into or towards surface water. The inspection will also document the progress of any plan element subject to a time schedule, or in

the process of being implemented. A monitoring plan will be included in the WRPP/SMP with points identified on map.

Onsite monitoring shall occur:

- Before and after any significant alteration or upgrade to a given stream crossing, road segment, or other controllable sediment discharge site. Inspection should include photographic documentation, with photo records to be kept on site.
- Prior to October 15 and December 15 to evaluate site preparedness for storm events and stormwater runoff.
- Following any rainfall event with an intensity of 3 inches precipitation in 24 hours. Precipitation data can be obtained from the National Weather Service by entering the site zip code at <http://www.srh.noaa.gov/forecast>.

A Monitoring and Reporting Form (Order No. 2015-0023 Appendix C) will be submitted upon initial enrollment in the Order (NOI) and then annually by March 31 to the Regional Water Board. The annual report will include data from the monitoring reports.

### **3.6. ENERGY AND GENERATOR USE**

Off-grid electricity is provided by solar panel for all domestic uses, with a generator when needed. All cultivation uses will be sourced by Honda 2000 watt and 3000 watt generators. Use of the on-site generator is limited to power outage events, and follows all guidelines set up by Humboldt County and the State of California. The generator is located away from the property line to ensure the noise level does not exceed 60 decibels at the property line. The generator and diesel fuel is located within a secondary containment trough.

### **3.7. USE AND STORAGE OF REGULATED PRODUCTS**

#### **3.7.1. BEST MANAGEMENT PRACTICES**

Best Management Practices (BMP's) are employed when storing, handling, mixing, application and disposal of all fertilizers, pesticides and fungicides. All nutrients, pesticides and fungicides are located in a locked storage room, and contained within water tight, locked and labeled containers in accordance with manufactures instruction. Application rates will be tracked and reported with the end of the year monitoring report required in the Water Resources Protection Plan (WRPP). Employees responsible for application are trained to handle, mix, apply or dispose of pesticides/fungicides with proper hand, eye body and respiratory protection in accordance with the manufacturer's recommendations. See the WRPP for complete BMP specifications for the use and storage of regulated products.

#### **3.7.2. FERTILIZERS**

Nutrients and biological inoculants used for cultivation include:

- Maxicrop Soluble Seaweed – 50 pounds
- Compost Tea
- Kelp Meal
- Fish Meal
- Bat Guano
- Humic Acid
- Glacial Rock Dust
- Alfalfa Meal
- Bokashi

- Insect Fass
- Aurora-707 Mix
- Royal Gold Mendomix
- Worm Castings

See Appendix B - *Regulated Products Resource List* for product details.

### **3.7.3. PESTICIDES AND FUNGICIDES**

Pesticides and fungicides used for cultivation include:

- Dyna Grow Neem Oil – 1 Gallon

See Appendix B - *Regulated Products Resource List* for product details.

### **3.7.4. FUELS AND OILS**

Fuels and oils stored on site include:

- Bleach, Clorox – 2 Gallons
- Ajax, Comet – 0.5 cans

## **3.8. WASTE MANAGEMENT PLAN**

### **3.8.1. SOLID WASTE MANAGEMENT**

Trash and recycling containers are located near the cabin. The trash containers are enclosed within a fenced area to prevent animal intrusion. Solid waste and recycling is hauled off-site to Fortuna Eel River Disposal transfer station at least once per week.

### **3.8.2. CULTIVATION WASTE AND SOIL MANAGEMENT**

Cultivation vegetative matter such as root balls, branches, and leaves are composted at a designated area. Spent potting soil is stored in storage buildings. The soil containment area is lined to prevent any soil erosion or nutrient seepage. The soils are amended and reused. If new soil is needed then it is bought. Used pots will be collected and stored in the storage buildings for the winter. All packaging from soil amendments and fertilizers will be collected and disposed at an appropriate facility.

### **3.8.3. WASTEWATER MANAGEMENT**

The water management plan aims to achieve an entirely closed-cycled irrigation and nutrient system. Hand watering methods minimize the over-irrigation on plants and subsequent runoff. Moreover, the greenhouse floors are unimproved and will absorb any excess runoff.

The residence contains an unpermitted septic system that is currently in use. The property owner is in the process of applying for a septic permit. In the interim, a portable toilet has been delivered to the site and will be serviced bi-weekly by Six Rivers Portable Toilets.

## **4. PRODUCT MANAGEMENT**

### **4.1. PRODUCT TESTING AND LABELING**

Samples are selected from individual harvested cannabis strains and are tested by a licensed third-party lab in accordance with State and local standards. The finished product is labeled with the Sunny Slope Ranch logo, and will include tracking ID's provided by the Statewide tracking systems when available.

#### 4.2. PRODUCT INVENTORY AND TRACKING

The Agent in Charge and Lead Cultivator ensure all commercial cannabis from clone to packaged product is tracked, accounted for and inventoried. Records are kept at each phase of the harvest operation for reporting and compliance with State and Local regulations. The information recorded for each harvest includes:

- Cultivation canopy area
- Weight of flowers, by-product, and trim waste after drying and separation
- Product ID numbers and product weight
- Staff identification (at each step)
- Physical location of the plant material at all times

Tracked products are required for legal entry into the State marketplace. Currently, the State marketplace does not have a tracking program online. At the time that the first annual licenses are distributed, a State sanctioned tracking program (Metr) will come online. All state-issued annual licensees are required to use the California Cannabis Track and Track (CCTT)-Metr system to record, track and maintain information about their cannabis, cannabis product inventories and activities. Cultivators pursuing State Licensure must complete the state-provided training before using the CCTT-Metr system.

#### 4.3. TRANSPORTATION AND DISTRIBUTION

Transportation will be handled by a third-party, contracted, licensed transporter/distributor in accordance with State and Local regulations. All merchantable product will be distributed through licensed commercial cannabis dispensaries. Prior to moving packages from the on-site holding facility to another physical location, a transport manifest will be created by the distributor/transporter and will include:

- Product ID numbers and product weight
- Route to be travelled
- Origin and destination addresses
- Time of departure
- Time of arrival

The *Agent in Charge* and *Manager* are responsible for performing a physical inventory of all packages being transported, and ensuring that the physical inventory coincides with the transport manifest.

## **Appendix A: Site Plan**

## **Appendix B: Cultivation Activities Schedule**



## CULTIVATION ACTIVITIES SCHEDULE

Item	Description	Jan	Feb	Mar	Apr	May	Jun	Jul	Aug	Sep	Oct	Nov	Dec
Drainage, Runoff, and Erosion Control	Winterization (storage of pots/greenhouse covers)												
	Temporary Erosion Control BMP's (straw, seeding, fiber rolls, etc)												
	Road maintenance												
	Culvert and Inboard ditch maintenance/inspection												
	Cultivation waste hauled off site												
	Cover soil beds and seed/straw with cover crop												
Irrigation Activities	Irrigation of juvenile plants /clones												
	Irrigation of flowering plants												
Pre-cultivation Activities	Propagate cuttlngs from 'mother plant' stock												
	Transplant cuttlngs into pots												
	Transplant clones into beds												
	Amend soil in greenhouses												
	Import new cultivation soil												
Mixed Light/ Light Dep Cultivation and Harvest Schedule	Mixed Light/ Light Dep Cycle 1												
	Mixed Light Cycle 2												
	Mixed Light Cycle 3												
	Harvest activities												
	Vegetative Phase: 15 hrs. min. of mixed natural and artificial light												
Light deprivation: Greenhouses are covered with blackout covers													
Outdoor Cultivation and Harvest	Outdoor Cultivation Cycle												
	Harvest activities												
Drying and Processing	Drying activities												
	Trimming activities												
Staffing Presence	Agent in Charge												
	Lead Cultivator												
	Assistant Cultivator/ Processing Manager												
	Seasonal Laborors												

## **Appendix C: References**

Bass, Ronald E., Kenneth M. Bogdan, and Terry Rivasplata. 2013. CEQA Desktop. Point Arena, CA; Solano Book Press. Page 44.

California Code of Regulations. Health and Safety Code Section 11357-11362.9.  
<<http://www.leginfo.ca.gov/cgi-bin/displaycode?section=hsc&group=11001-12000&file=11357-11362.9>> Date accessed: July 16, 2014.

California NORML. SB 420 Establishes Prop. 215 Guidelines, Voluntary Patient Identification Card System.  
<<http://www.canorml.org/laws/sb420.html>> Date accessed: July 21, 2014.

County of Humboldt. *Medical Marijuana Land Use Ordinance (MMLUO) – Phase IV, Commercial Cultivation, Processing, Manufacturing and Distribution of Cannabis for Medical Use* (Staff Report to the Board of Supervisors). January 26, 2016. <<https://humboldt.legistar.com/Calendar.aspx>> Date accessed: March 28, 2016.

North Coast Regional Water Quality Control Board. 2016. *Cannabis Cultivation Waste Discharge Regulatory Program*. [http://www.waterboards.ca.gov/northcoast/water\\_issues/programs/cannabis/](http://www.waterboards.ca.gov/northcoast/water_issues/programs/cannabis/). Date accessed: March 28, 2016.

State Board of Equalization. Information on the Sales and Registration for Marijuana Sellers. June 2007.  
<<http://www.boe.ca.gov/news/pdf/173.pdf>>

State of California. Guidelines for the Security and Non-Diversion of Marijuana Grown for Medical Use. August 2008.  
<[http://www.ag.ca.gov/cms\\_attachments/press/pdfs/n1601\\_medicalmarijuanaguidelines.pdf](http://www.ag.ca.gov/cms_attachments/press/pdfs/n1601_medicalmarijuanaguidelines.pdf)>



Reference: 019107

August 21, 2019

Tad Diaz  
Sunny Slopes Ranch, LLC  
369 Church Lane  
Carlotta, CA 95528

**Subject: Engineering Geologic Evaluation of Existing Cultivation Areas, Sunny Slopes Ranch, 26980 State Highway 36, Bridgeville, California; , APN 208-112-024**

Dear Tad Diaz:

This letter provides the results of SHN's recent engineering geologic evaluation of the Sunny Slopes Ranch (Assessor's parcel number [APN] 208-112-024) in Bridgeville, California. Our evaluation was focused on assessment of mapped unstable areas at the site, and the potential impact to existing cultivation sites that are in close proximity to these areas. This work is being completed in the context of ongoing permitting at the site for cannabis cultivation. Specifically, this report is in response to a request from the Humboldt County Planning and Building Department, dated January 18, 2019 (relative to Permit Application No. 11296). The 2017 Humboldt County General Plan policy, section S-P11 states new development may be approved only if it is demonstrated it will "neither create nor significantly contribute to, or be impacted by, geological instability or geologic hazards." The County's request, consistent with the relevant General Plan policy, defines the need for a geologic assessment of the mapped unstable areas at the subject site, and this report is intended to satisfy that request.

Using the County's nomenclature, this is an "R-2" level report. Our assessment and reporting are focused on the interpretation of unstable areas at the site, and should not be construed as an assessment of overall geotechnical site conditions.

Our work scope for this assessment includes the review of available geologic literature and maps, interpretation of publicly available aerial imagery, site reconnaissance, and preparation of this letter report. We visited the site on July 12, 2019.

## Geologic Setting

The site is located on the lower valley wall slopes adjacent to Little Larabee Creek, about 2 miles east of the town of Bridgeville. The area occurs on the northern valley wall slope, and, therefore, slopes at the subject ranch have a southern aspect, with moderate gradient. Little Larabee Creek is a Class I tributary that flows northwestward to the Van Duzen River; the site is about 1.5 miles upstream of the confluence.

Published geologic mapping indicates the site is underlain by mélangé associated with the central belt of the Franciscan Complex (McLaughlin and others, 2000). Site conditions are

consistent with this designation—we noted many emergent rock blocks in the area, typical of *mélange* terrain in Humboldt County. The McLaughlin and others (2000) mapping identifies a series of “*mélange* blocks” at the site and in the site vicinity (specifically, the map shows a series of “greenstone” blocks). Landsliding in *mélange* terrain, especially rocky *mélange* terrain, such as, that at the subject site, occurs as pockets of soft matrix material in the intervening areas between rock blocks. These soft areas are subject to earthflow type landsliding, typically activated during periods of increased rainfall.

Available geomorphic mapping shows the site vicinity as an area associated with sparse landsliding. Landslide mapping by the California Geological Survey (Spittler, 1983) shows isolated patches of “disrupted ground” along the upslope property boundary (near existing cultivation areas), and two localized streamside landslides along Little Larabee Creek. “Disrupted ground” is described as an area with an “irregular ground surface” that may be caused by “complex landsliding, soil creep, and/or erosion.” It is a vague classification typically applied to prairie ground (grass lands) in the region, where the presence of exposed rock blocks result in hummocky terrain.

The “disrupted ground” designation does not imply these areas are subject to “active” or “historic” landsliding (in fact, they are specifically NOT shown as “active” slides, a distinct map category when indicated); they are merely areas associated with irregular ground (in this case, grassy prairie ground). The County incorrectly and inappropriately uses the California Geological Survey (CGS) landslide mapping on its geographic information system (GIS) database by referring to all landslide features as “historic,” regardless of the age classification (or lack thereof) shown on the CGS maps. In reality, very few of the slides shown on the CGS maps are depicted as “historic.”

There are clear areas of recent landsliding along Little Larabee Creek, in the areas shown on the CGS map, and in additional areas along what appears to be an active inner gorge. These areas are far removed and geologically isolated from the developed parts of the site, and are not included in this assessment.

## Site Conditions

The upper part of the subject site, in the vicinity of the mapped “disrupted ground,” is occupied by two greenhouse structures. These greenhouses occupy modest earthen terraces that we understand were built by hand some 11 to 12 years ago. The earthwork resulted in fill berms on the order of 3 to 5 feet in thickness, and a cut slope above the upslope greenhouse that is about 3 feet high.

The areas surrounding the subject greenhouses are notably rocky. Numerous rock (blue schist, greenstone) outcroppings were observed on the slopes directly adjacent to the developed areas. As such, the areas appear inherently stable, and we observed no evidence of landsliding in the vicinity of the subject improvements. Minor, localized pockets of soft ground appear to occur in the prairie ground west of the existing developed areas (in the western zone of mapped “disrupted ground”), but these are isolated between apparent rocky areas, and will have no impact on the proposed cultivation areas.



Active landsliding along Little Larabee Creek is far removed from the developed portions of the site, and is not impacted by the ongoing upslope cultivation operations. These slides are a minimum of 300 feet from the nearest structure, separated by uninterrupted forestlands.

## Conclusions

Based on the conditions we observed, the subject site appears to be a favorable location for the proposed activities from a geologic hazard standpoint. We did not observe evidence of recent or historic landsliding near the existing cultivation sites, and due to the relatively stable site conditions, there is a low potential the site activities will trigger any instability. Assuming best management practices, the existing operations are essentially innocuous relative to the landscape upon which they occur. Areas of "disrupted ground" on the upper slopes shown on the pertinent CGS mapping (and subsequently adopted by the County) are not "historic," as stated by the County; there is no geomorphic field evidence for "historic" landslides on the upper slope relative to the subject cultivation sites (or otherwise).

Active inner gorge landsliding along Little Larabee Creek is irrelevant relative to the ongoing cultivation operations that are occurring a minimum of 300 feet upslope.

Based upon review of the site and surrounding terrain, it is our professional opinion that no further soils mechanics analyses are required; therefore, input from a geotechnical engineer is not warranted for this project.

## Limitations

This is an inherently focused evaluation of geologic hazard conditions at the subject site. This investigation is intended for a limited audience, specifically county planners evaluating potential impacts related to cannabis cultivation at the site. It applies to the site described herein, and not to other sites, and it applies at the time of our investigation. Geologic conditions may change over time, especially under intense seismic shaking, which may occur within our region. The assessment is based on visual inspection of geomorphic conditions; subsurface investigation or monitoring is beyond the scope of this investigation.

We hope that this assessment provides the information you need at this time. If you have additional questions or require clarification of the information presented herein, please call me at (707) 441-8855.

Respectfully,

SHN

  
Gary D. Simpson, CEG  
Sr. Engineering Geologist

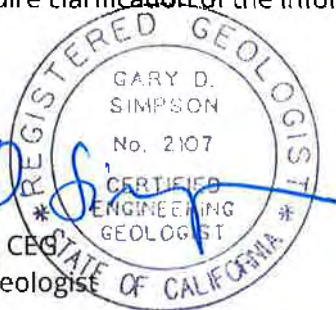

GDS:lms



## References

- McLaughlin, R.J., and 7 others (2000). Geology of the Cape Mendocino, Eureka, Garberville, and Southwestern part of the Hayfork 30 x 60 Minute Quadrangles and Adjacent Offshore Area, Northern California: U.S. Geological Survey Miscellaneous Field Studies MF-2336. 27 p., 6 plates. NR:USGS.
- Spittler, T. (1983). Geology and Geomorphic Features Related to Landsliding, Bridgeville quadrangle, Humboldt County, California. California Division of Mines and Geology Open-file Report OFR 83-23 SF. Scale 1:24,000. NR: CA. Dept. of Conservation, Division of Mines and Geology.



# SITE MANAGEMENT PLAN

(NCRWQCB Water Resource Protection Plan)

In fulfillment of  
Order WQ 2017-0023-DWQ & NCRWQCB order Order No. 2015-0023  
General Waste Discharge Requirements and Waiver of Waste Discharge Requirements for  
Discharges of Waste Associated with Cannabis Cultivation Activities

Prepared for:

**Sunny Slope Ranch, LLC**

and

State Water Resources Control Board



**Tier 1, High Risk Discharger**  
**WDID: 1B171048CHUM, Tier 2**

Prepared by:



Michelle Aldrete  
Michelle@northpointeureka.com  
(707)798-6438  
July 2018



---

## TABLE OF CONTENTS

INTRODUCTION

SITE INFORMATION

TIER AND RISK DESIGNATION

BEST PRACTICAL TREATMENT OR CONTROL (BPTC) MEASURES

1. Sediment Discharge Measures
  - 1.1. Site Characteristics
    - 1.1.2. Road Conditions
    - 1.1.3. Water Bodies, Stream Crossings, Riparian Setbacks
    - 1.1.4. Soil Disturbance
  - 1.2. Sediment Erosion Preventions and Sediment Capture
    - 1.2.1 Erosion Prevention BPTC Measures
      - 1.2.1.1. Roads
      - 1.2.1.2. Disturbed Areas
      - 1.2.1.3. Streams and Stream Crossings
      - 1.2.1.4. Winterization
    - 1.2.2. Sediment Capture BPTC Measures
      - 1.2.2.1. Roads, Stream Crossings, and Soil Disturbance
    - 1.2.3. Maintenance Activities - Erosion Prevention and Sediment Control
      - 1.2.3.1. Monitoring
      - 1.2.3.2. Maintenance
2. Fertilizer, Pesticide, Herbicide, and Rodenticide BPTC Measures
  - 2.1. Cultivation Product Storage, Use, and Disposal
    - 2.1.1. Storage
    - 2.1.2. Application
    - 2.1.3. Disposal and Spill Prevention/Cleanup
3. Petroleum Product BPTC Measures
  - 3.1 Petroleum Storage, Use, and Disposal
    - 3.1.1. Storage
    - 3.1.2. Application
    - 3.1.3. Disposal and Spill Prevention/ Cleanup
4. Trash/Refuse and Domestic Wastewater BPTC Measures
  - 4.1. Household Trash and Cultivation-related Waste
  - 4.2. Residents, Employees, and Visitors
    - 4.2.1. Domestic Wastewater - Generation
    - 4.2.2. Domestic Wastewater - Disposal



## 5. Winterization BPTC Measures

### 5.1. Activities and Maintenance

#### 5.1.1. Roads and Stream Crossings

#### 5.1.2. Disturbed Areas

#### 5.1.3. Storage and Stockpiled Materials

##### 5.1.3.1. Cultivation-related Products and Waste

##### 5.1.3.2. Vehicles, Machines, and Petroleum Products/Waste

##### 5.1.3.3. Stockpiled Materials

## **APPENDICIES**

Appendix A: Site Map

Appendix B: Disturbed Area Map

Appendix C: BPTC Implementation and Maintenance Schedule

Appendix D: BPTC Measure Specifications

Appendix E: References

Appendix F: Water Use Records

Appendix G: Fertilizer, Pesticide, Herbicide, and Rodenticide Product List and Records

Appendix H: Monthly BPTC Monitoring and Maintenance Records

Appendix I: Small Domestic Use Registration Certificate

---

## INTRODUCTION

This Site Management Plan (SMP)/Water Resource Protection Plan (WRPP) has been developed to satisfy conditions of the Tier 1 enrollment requirements in the State Water Resource Control Board (SWRCB) Order No. WQ 2017-0023-DWQ (Order), and Order No. 2015-0023 for the North Coast Regional Water Quality Control Board (NCRWQCB). The purpose of the Order is to implement the Cannabis Policy requirements for waste discharges associated with cannabis cultivation. The Policy provides a structure for managing water quality and instream flow impacts associated with cannabis cultivation. It also establishes criteria for personal use and site conditional exemptions and includes a tiered approach for permitting discharges of waste. All eligible dischargers developing land for cannabis cultivation activities are required to enroll in the program under the Order. Dischargers must implement Best Practical Treatment or Control (BPTC) measures and submit technical and monitoring reports to assure compliance with the Order. The SMP describes how the discharger is complying with the applicable BPTC measures listed in the Policy and how they are being implemented property-wide.

---

## SITE INFORMATION

**Registrant:** Thadeus Diaz  
369 Church Lane  
Carlotta, CA 95528

**Site Address:** 26980 State Highway 36  
Bridgeville, CA 95528

**Parcel:** Assessor Parcel Number: 208-112-024  
Lat/Long: 40.4724°, -123.7571°

**Zoning:** General Plan: RA40 (Residential Agriculture)  
Zone:FR-B-4(40) (Forestry Recreation)

**Acres:** Approximately 38.32 acres (Humboldt County WebGIS)  
Disturbed Area: Approximately 0.73 acres

**Location:** The site is located in the Eel River Watershed in east-central Humboldt County, on State Highway 36, approximately 27 miles east of Highway 101. To reach the site from Eureka, take US-101 south from Eureka for 20 miles to exit 685 for CA-36 and turn east. Take CA-36 E for 27 miles. The destination will be on the right-hand side at mile marker 27.02 on CA-36.

In addition, a risk designation is assigned based on the slope of the disturbed areas and proximity to a waterbody. Based on these parameters, the subject property is designated as a **High Risk**. The total disturbed area, of 0.73 acres, does not remain outside of the riparian setback requirements. Greenhouse E is currently 30 ft away from a Class III watercourse. The registrant aims to reduce the size of the greenhouse to meet the 50 ft riparian setback. Greenhouse A and B are within the riparian setback. The registrant plans to reduce square footage and rearrange the greenhouses to meet the 50 ft riparian setback. There are existing water tanks that do not meet the riparian setbacks, these will be relocated outside of the 50 ft set back. However, the disturbed area is on slopes less than 30 percent.

---

## **BEST PRACTICAL TREATMENT OR CONTROL (BPTC) MEASURES**

BPTC measures are being utilized as part of the road maintenance program to protect water quality. The *Solid Waste Management, Construction Site Best Management Practices Manual* by the CA Department of Transportation (Caltrans) is referenced for the correct installation, maintenance, and monitoring of all applicable erosion control and sediment capture BPTC measures.

All straw mulch must be free of noxious weeds and all seed/plants must be non-invasive. A list of prohibited species can be found in the CA Invasive Plant Council's database. Erosion control measures shall not include synthetic monofilament netting, including photo- and biodegradable plastic netting. All netting shall be made of jute, coir fiber, hemp, or another product without welded weaves.

A schedule of BPTC measures to be implemented and maintained throughout the site is shown in Appendix C, and Appendix D includes specifications for BPTCs.

---

### **1. SEDIMENT DISCHARGE BPTC MEASURES**

#### **1.1. SITE CHARACTERISTICS**

##### **1.1.1. SITE MAP**

The site map shows all relevant site features: streams, stream crossings, storage areas, roads, buildings, domestic wastewater treatment system, cultivation areas, and other disturbed areas related to cultivation activities. Erosion prevention and sediment control BPTC measures are identified on the map (see Appendix A).

##### **1.1.2. ROAD CONDITIONS**

The main entrance road receives approximately two daily vehicle trips in the peak season (May - October) and limited to no vehicle trips in the winter season. The entry road is constructed on a steep gradient and the

**Site Description:**

Sunny Slope Ranch, LLC is located within the Eel River Watershed. Little Larabee Creek, tributary to Van Duzen River, runs along the south portion of Property. The property primarily consists of dense timber land with grass land on the east and northwest portion of the property. According to WebGIS the relative slope stability of the property is classified as high instability. Additionally, the property contains an existing 1,200 sf single family residence constructed around 2004. There is approximately 417,000 gallon of off stream water storage throughout the property. The discharger has a claimed water rights for irrigation of approximately 18,240 sf of cultivation (S025008). Separately, the discharger has claimed water rights for domestic purposes for up to three season full-time employees (S025008 and S025309). As of July 8, 2015, the registrant has a certificate for Small Domestic Use Registration (SDUR) (Registration No. D032480, Certificate No. D961). Refer to Appendix F and I for a summary of existing Water Diversion Storage and Use and the SDUR Certificate.

**TIER AND RISK DESIGNATION**

The Cannabis Policy provides criteria for evaluating threats to water quality for cannabis cultivation sites based on three site characteristics: proximity to water body, total disturbed area, and slope of the disturbed area. Based on the criteria and site characteristics the subject property is designated as a **Tier 1 Discharger**. The total disturbed area is 0.73 acres (Table 1).

Table 1. Disturbed Areas

Type	Area (ft <sup>2</sup> )	Approximate Distance to Waterbody (ft)	Waterbody Type
Cultivation	18,240	10	Class III
Shop, Storage, Processing	1,200	95	Class III
Shop, Storage, Processing	1,200	160	Class III
Storage Structure	440	120	Class III
Pesticide and Agricultural Chemical Storage Structure	1,230	165	Class III
Residence	1,200	60	Class III
Spent Soil and Vegetative Waste	800	230	Class III
Pond	7,300	275	Class III
Water Storage Tanks	356	15	Class III
<b>Total: 31,966 ft<sup>2</sup> or 0.73 acres</b>			

The main entrance road was constructed prior to cultivation activities and is maintained according to the guidance provided by the *Handbook for Forest, Ranch, and Rural Roads* (“Road Handbook”) by Pacific Watershed Associates. Thus, the area of the road network is not included in the total disturbed area. See the disturbed area map in Appendix B for specific areas included in the disturbed area.

road surface consists of bare soil. Much of the road is insloped, which drains the road surface flow into inboard ditches. Sections of the ditches, below the main entry, show signs of minor incising. On certain portions of the road, surface flow tends to concentrate and causes rilling along the surface. Currently, road maintenance activities consist of clearing inboard ditches of debris and installing multiple rolling dips on the main road and roads that lead to cultivation. Additional road maintenance is prescribed in section 1.2.1.

**1.1.3. WATER BODIES, STREAM CROSSINGS, RIPARIAN SETBACKS**

Stream crossing 1 consists of an existing 18” diameter plastic culvert at the headwall of a Class III watercourse. The stream crossing is installed on gradient and is appropriately sized. Set back requirements are not met for stream crossing 1. The applicant intends to reduce the size of the existing outdoor greenhouse to meet setback requirements in the near future.

Stream crossing 2 consists of an existing 36” diameter metal culvert in a redirected Class III watercourse. The headwall of the drainage is on a grassy hillside with shrubs and oaks surrounding the drainage. From the hill side, the drainage is redirected by 80 ft of inboard ditch leading to the 36” culvert. The culvert is installed on gradient and appropriately sized. The outlet of Stream Crossing 2 contains extensive gulying due to legacy issues. Four rock check dams will be installed blow Stream Crossing 2, approximately 80 ft apart, with the intention of reducing erosion. Set back requirements are not met approximately 200ft below of stream crossing 2. In the future, the applicant intends to reduce square footage and rearrange the (2) two existing greenhouses to meet the setback requirement of 50 ft.

Stream crossing 3 consists of a seasonal rocked ford crossing in a Class III intermittent drainage. There are short approaches leading up to the crossing, but the approaches are not eroding or delivering sediment to the stream. The client will be maintaining the crossing as needed with a layer of small sharp angular rock applied over large rock to keep vehicle traffic elevated above the watercourse.

**1.1.4. SOIL DISTURBANCE**

The site has no areas of active soil disturbance. All historic graded areas are stable and vegetated, and there are no active slides or earth movement on site.

**1.2. SEDIMENT EROSION PREVENTION AND SEDIMENT CAPTURE**

**1.2.1. EROSION PREVENTION BPTC MEASURES**

**1.2.1.1. ROADS**

The discharger will be installing multiple rolling dips throughout the property (see site map in Appendix A). Rolling dips are located on the main access road leading to the residence and on roads leading to cultivation. Sections of the road leading to cultivation will be outsloped to disperse road surface flow off the road. Road surfaces are rocked and maintained as needed. Steep roads are not used during the winter period. Separately, the discharger has an access road that is shared with the adjacent property to the west.

Inboard ditches that are actively incising will be rocked to prevent additional down-cutting. Culvert inlets and outlets will be maintained and cleared of sediment buildup. The culvert outlets discharge onto stable, vegetated or armored slopes and not into natural watercourses.

Erosion prevention measures roads will be implemented during the dry summer months. The road construction standards described in the "Road Handbook" will be adhered to for all road improvements. See Appendix C for the Schedule of BPTC Implementation and Maintenance.

1.2.1.2. DISTURBED AREAS

All exposed soil in disturbed areas will be seeded and mulched with straw and existing live mulch will be maintained. Any areas for planned disturbance/development will be surveyed for sensitive species, wildlife, and communities, and CDFW shall be consulted with to designate a no-disturbance buffer if necessary.

1.2.1.3. STREAMS AND STREAM CROSSINGS

Stream crossing inspection and maintenance, such as the removal of debris, will be regularly conducted throughout the year, and after a significant storm event (0.5 in/day or 1 in/7 days of rain). All cultivation operations will comply with setbacks from streams and riparian areas in the near future. The existing riparian vegetation has been preserved and the buffer width maintained. Biological or structural BPTC measures will be implemented.

1.2.1.4. WINTERIZATION

Winterization measures will be implemented annually by November 1<sup>st</sup> and interim erosion prevention BPTC measures will be utilized as needed throughout the year. To prevent erosion and sediment transport to streams, numerous measures for soil stabilization, runoff management, erosion and sediment prevention/retention are utilized throughout the seasonally dry period and prior to the onset of winter. Section 5 "Winterization

BPTC Measures” has more information on proposed actions to protect water quality in the winter season.

#### 1.2.2. SEDIMENT CAPTURE BPTC MEASURES

##### 1.2.2.1. ROADS, STREAM CROSSINGS, AND SOIL DISTURBANCE

Spoils piles and spent potting soil is stabilized in a location outside of riparian setbacks and are surrounded with straw wattles and a tarp or mulch for cover (see site map in Appendix A). Live willow cuttings or check dams will be applied at culvert outlets that drain onto an exposed slope. Four rock check dams will be installed below Stream Crossing 2, refer to Appendix A, approximately 80 ft apart.

During road construction, sediment control devices (e.g. straw wattles, gravel bag berms) will be installed during the dry season around culvert inlets and outlets to prevent sediment delivery to the streams. Stockpiled materials for construction and road maintenance will be stored in stable locations and contained using appropriate BPTC measures. Other sediment control measures may be installed as needed to prevent discharges from entering waters of the state. See Appendix C for the schedule of all sediment control BPTC measures being employed on site.

#### 1.2.3. MAINTENANCE ACTIVITIES – EROSION PREVENTION AND SEDIMENT CAPTURE

##### 1.2.3.1. MONITORING

Stream crossings should be monitored for plugging of debris. The outlet of stream crossing 2, Monitoring Area 1, should be monitored due to the legacy issues that have caused extensive gullyng. Rock check dams will be installed to as a measure to reduce erosion. The check dams should be monitored and maintained as needed. The rocked ford should be monitored in case of erosion.

All long-term and interim erosion prevention and sediment capture BPTC measures that have been implemented will be monitored for effectiveness on a monthly basis at a minimum (Table 1.2.3.1). Any vegetation planted on previously disturbed areas will be monitored for success and replanted if necessary. The cultivator will monitor erosion and sediment control measures during and after each storm event that produces at least 0.5 in/day or 1 in/7 days of precipitation. In addition, winterization measures that are implemented will be monitored for effectiveness (inspected during the first major winter storm event) before the site is closed for the winter. See Appendix H for a log of monthly BPTC monitoring and maintenance records.

Table 1.2.3.1. BPTC Effectiveness Monitoring

Observations	Description	Monitoring Frequency
<b>Erosion Prevention and Sediment Capture Maintenance</b>	Report activities for maintaining the effectiveness of erosion prevention and sediment retention/capture measures	Monthly
<b>Active Erosion</b>	Report any indications of soil erosion	Monthly
<b>Surface Water Runoff Maintenance</b>	Report the conditions of any surface water (stormwater, irrigation) and include the location, source of runoff, duration	Monthly
<b>Stormwater Runoff Constituents</b>	Turbidity – conduct sampling once per month when precipitation exceeds 0.25 in/day or when stormwater runoff is generated on site pH – conduct sampling once per month when precipitation is forecast to exceed 0.25 in/day	Every month until winterization procedures are completed.
<b>Disturbed Area Stabilization</b>	High risk dischargers shall provide a status report describing activities conducted to stabilize the disturbed area with the setback	Monthly
<b>Materials Storage Erosion/Spills Prevention</b>	Report materials delivered or stored on site that have the potential to degrade water quality if discharged	Monthly
<b>Septic, Holding Tank, or Chemical Toilet Servicing</b>	Report the name of the servicing company, dates, and activity	Monthly

1.2.3.2. MAINTENANCE

Maintenance will be provided as needed to the stream crossing, rock check dams, and ditch relief culverts. This includes removal of any debris that may cause plugging at the inlet and outlet of culverts. Inboard ditches will be maintained and cleared as needed.

Year-round maintenance of all erosion prevention and sediment capture measures is required. All existing measures shall be maintained, repaired, or replaced as needed. Exotic or invasive species found in revegetated or disturbed areas shall be removed. Remaining exposed soil shall be reseeded/revegetated and have 2-4" of weed-free mulch reapplied. Any captured sediment in inboard ditches/drainageways, culvert outfalls, or against silt fences/straw



wattles will be removed and stabilized on a designated flat area. The sediment may be used for site improvement where it will not threaten water quality. Interim measures for sediment retention, such as mulching and wattling, require more regular monitoring and maintenance. See Appendix H for a log of monthly BPTC monitoring and maintenance records.

## **2. FERTILIZER, PESTICIDE, HERBICIDE, AND RODENTICIDE BPTC MEASURES**

### **2.1. CULTIVATION PRODUCT STORAGE, USE, AND DISPOSAL**

#### **2.1.1. STORAGE**

Fertilizers and pesticides are stored in separate locations. Prior to application, fertilizers are located within a locked storage room and stored within secondary containment containers (see Site Map in Appendix A for storage location). Employees that are responsible for application will be properly trained and will have access to proper protection equipment.

Appropriate BPTC measures are being utilized when storing, handling, mixing, applying, and disposing of all fertilizers, pesticides, herbicides, and rodenticides. Each year an inventory is conducted prior to the beginning of the grow season and necessary products are delivered to the site as needed. See Appendix G for a list of fertilizers and pesticides/herbicides used on site.

#### **2.1.2. APPLICATION**

Mixing of fertilizers in small storage tanks is conducted in a designated area where the mix will not enter surface waters. For young plants, the mix is applied via hand watering methods and mature plants are fertigated at agronomic rates by drip emitters. Spent potting soil is stored within a building with the used pots. The spent potting soil will be amended and reused as needed. The application of any agricultural chemical products will be conducted according the manufacturer's recommendation. The soil contaminant areas are lined and covered to prevent any soil erosion or nutrient seepage. All packaging from soil amendments will be collected and disposed at a proper facility.

#### **2.1.3. DISPOSAL AND SPILL PREVENTION/CLEANUP**

Trash and recycling containers are located near the Drying and Storage Buildings, enclosed within a fenced area preventing surface water contamination and wildlife intrusion. Excess soil not slated to be reused or mulched will be disposed of properly along with other cultivation products, and the disturbed area will be seeded and covered with straw to prevent erosion. Spent product containers are carefully transferred from the mixing area to the refuse area. A spill kit with plenty of sorbent pads is kept on site in the event of a spill. All trash, empty product

containers, and other recycling are hauled off-site bi-weekly to the Fortuna Eel River Disposal transfer station.

### 3. PETROLEUM PRODUCT BPTC MEASURES

#### 3.1. PETROLEUM STORAGE, USE, AND DISPOSAL

Table 3.1. Petroleum Product List, Storage, and Use

Petroleum Product	Delivery Period	Storage Method	Use Type
Gasoline	(12) Twelve 5-gallon gas cans are filled up as needed throughout the growing season (April - October)	(12) Twelve 5-gallon gas cans contain spill proof spouts and are stored in a metal trough as secondary containment.	Fuel is used for multiple Honda 2,000 watt, Honda 3,000-watt, Honda 7,000-watt, Honda 5,000-watt, and (1) one Kohler 65-kilowatt generator. The generator use is limited to power outage events and water pumps.
Propane Tank	As needed throughout the year	120-gallon metal propane tank from AmeriGas located in Arcata, CA.	Heating
Lubricants	As needed throughout the year	In storage shed within secondary containment	Equipment maintenance

#### 3.1.1 STORAGE

The discharger uses (12) twelve 5-gallon gas cans that contain spill proof spouts. Gas cans are located inside of a storage structure, separate than pesticides and fertilizers, and within a metal trough for secondary containment (see site map in Appendix A). When refueling generators, gas cans will be stored within secondary containment. Fuel is safely transported on site as needed. Additionally, the discharger has a 120-gallon propane storage tank located in front of Drying and Storage Building #2 (see site map in Appendix A). The propane tank is located on top of concrete platform. All fuel, petroleum, and lubricant are stored in secondary containment when not in use. The generators on site are as listed: (1) one 5,000-watt Honda generator, (1) one 7,000-watt Honda generator, (3) three 2,000-watt Honda generators, (3) three 5,000-watt Honda generators, and (1) one 65-kilowatt Kohler generator. Each of the Honda generator contain metal drip pans and are being stored within the storage structures, outside of riparian setbacks, when not in use. The larger generator, 65-kilowatt Kohler generator, is located within

its own facility with a cement containment floor in a covered building (see site map in Appendix A; Storage Building #1). Vehicles and machines are regularly monitored for leakage and when not in use are being stored in a location outside riparian setbacks.

**3.1.2. APPLICATION**

Fueling and maintenance of the generators, cars, and other machines is being conducted in a designated area that prohibits discharge to waters of the state.

**3.1.3. DISPOSAL AND SPILL PREVENTION/CLEANUP**

Special care is taken when transporting and handling all petroleum products. Spill prevention/cleanup BPTC measures are being utilized; a spill kit with plenty of sorbent pads is kept on site in the event of a spill. Spent petroleum products and related trash are kept in secondary containment, specifically for hazardous waste, before being transferred to the waste management facility.

**4. TRASH/REFUSE AND DOMESTIC WASTEWATER BPTC MEASURES**

**4.1. HOUSEHOLD TRASH AND CULTIVATION-RELATED WASTE**

All trash/refuse generated on site will be enclosed within a designated fenced area in a near the Drying and Storage Buildings (see site map in Appendix A) where it will not migrate or leach into waters of the state. Cultivation-related organic waste is composted in a designated area and stabilized with the appropriate BPTC measures. Spent potting soil is stored in a secure location and stabilized using appropriate sediment control BPTC measures. Household and other cultivation-related waste and recycling are temporarily stored in wildlife-impenetrable storage containers. All refuse and cultivation waste are then transported to the Eel Rivers waste management facility approximately twice a month.

**4.2. RESIDENTS, EMPLOYEES, AND VISITORS**

Approximately 2 residents are on site during the growing season, and a maximum of 3 employees are on site during the peak operation season. There are no residents or employees on site in the winter season. No visitors come to the site.

**4.2.1 DOMESTIC WASTEWATER - GENERATION**

The household produces greywater from the kitchen sink, and there is no blackwater since a portable toilet is used on site.

**4.2.2 DOMESTIC WASTEWATER - DISPOSAL**

The residence contains an unpermitted septic system that is currently in use. The property owner is in the process of applying for a septic permit. In the interim, a portable toilet has been delivered to the site and will be serviced bi-weekly by Six Rivers Portable Toilets. See the

site map in Appendix A for locations of wastewater treatment locations. The cultivator shall make sure that no substances that are hazardous to fish and wildlife (e.g. trash, paint, concrete washings, treated wood) are used, located, or disposed of where they can contaminate waters of the state. Human and animal waste shall also be disposed of properly.

## **5. WINTERIZATION BPTC MEASURES**

### **5.1. ACTIVITIES AND MAINTENANCE**

#### **5.1.1 ROADS AND STREAM CROSSINGS**

Appropriate erosion prevention and sediment control measures will be installed, maintained, and monitored for effectiveness prior to the winter season. Road work requiring heavy machinery, such as outsloping, shall be conducted only during the dry season, unless the cultivator is authorized by an agency with jurisdiction to make emergency repairs. Temporary access roads also need to be closed to traffic prior to the onset of winter. The main access road has excessive sheet flow lengths that will be improved by outsloping and rolling dips. Winterization of the main access road includes temporary and long-term runoff management and soil stabilization measures, such as the rocking of inboard ditches, installing check dams, and stream inlet protection. All winterization BPTC measures will be monitored and maintained prior to site closure for the winter. Culverts will be inspected for erosion or clogging prior to and after a significant storm event. Any debris and sediment found to be clogging culverts, inlets/outlets, or drainageways will be removed and appropriately stored, reused, or disposed of.

#### **5.1.2. DISTURBED AREAS**

Areas that have exposed soil shall be seeded/hydroseeded and mulched to prevent erosion and sediment delivery to a waterbody. Any revegetation shall take place at the onset or at the end of the precipitation season to ensure establishment. Exposed slopes shall have linear sediment controls, such as wattles or silt fences, to interrupt sheet flow lengths. All disturbed areas will be inspected for potential and active erosion issues. Such sites will be repaired/controlled as needed using appropriate BPTC measures. For all areas of concern, if any BPTC measures cannot be installed prior to winter, the Regional Water Board must be contacted to establish a compliance schedule to protect water quality.

#### **5.1.3. STORAGE AND STOCKPILED MATERIALS**

##### **5.1.3.1. CULTIVATION-RELATED PRODUCTS AND WASTE**

All fertilizers, pesticides, herbicides, and rodenticides need to be stored where they will not enter surface waters or pose a threat to wildlife. The cultivator will have all liquid products stored in secondary containment and stored along with all other cultivation-related products, protected from the elements. Waste associated with cultivation will be removed from the site and taken to the Petrolia waste management facility prior to closing the site for winter.

5.1.3.2. VEHICLES, MACHINES, AND PETROLEUM PRODUCTS/WASTE

Prior to winter, any remaining vehicles or machines on-site will be stored out of the elements where any potential leaks will not enter surface waters or pose a threat to wildlife. The generator shed will also be locked to prevent wildlife intrusion. Petroleum products will be kept in compatible secondary containment within their own storage container. Any spent petroleum containers and related trash will be removed and appropriately disposed of at the Petrolia waste management facility.

5.1.3.3. STOCKPILED MATERIALS

Appropriate BPTC measures shall be used for all stockpiled materials that have the potential to migrate to surface waters or that may be hazardous to wildlife. Stockpiled materials include bark, sawdust, potting soil, amendments, rock, compost, treated wood, polytube and other irrigation equipment, greenhouse plastic sheeting, and any other materials used for cultivation and site development, improvement, and management. They shall be stabilized in an upland area, covered, and/or stored in a storage shed/container.

## **Appendix A: Site Map**



**VICINITY MAP**  
NOT TO SCALE

**DIRECTIONS TO SITE**

- FROM EUREKA, CA  
 - TAKE HIGHWAY 101 SOUTH FOR ±20 MILES  
 - EXIT HIGHWAY 36 EAST AT ALTON  
 - TAKE HIGHWAY 36 FOR ±27 MILES  
 - TURN RIGHT ON UNNAMED DIRT ROAD AFTER STEEP HAIRPIN AFTER BRIDGEVILLE AND BEFORE MCLELLAN MOUNTAIN  
 - FOLLOW DIRT ROAD FOR ±1.2 MILES  
 - PROJECT LOCATION AFTER WOODEN FENCE ON THE RIGHT AT THE BOTTOM OF THE HILL

# SUNNY SLOPE RANCH, LLC

## SITE MANAGEMENT PLAN

APN: 208-112-024

**PROJECT DESCRIPTION:**

THE PROJECT SITE IS IN THE EEL RIVER WATERSHED. LITTLE LARABEE CREEK, TRIBUTARY TO THE VAN DUZEN RIVER, RUNS ALONG THE SOUTHERN PORTION OF THE PROPERTY. THE SITE IS ENROLLED WITHIN THE NORTH COST REGIONAL WATER QUALITY CONTROL BOARD AS A TIER 2 DISCHARGER. THE SITE MANAGEMENT PLAN ACTS AS BOTH THE WATER RESOURCES PROTECTION PLAN AS WELL AS A SITE MANAGEMENT PLAN FOR THE STATE WATER RESOURCES CONTROL BOARD GENERAL ORDER FOR CANNABIS CULTIVATORS. UNDER THE STATE GENERAL ORDER SUNNY SLOPE RANCH WILL ENROLL AS A TIER 1, HIGH RISK DISCHARGER IN JULY OF 2018.

**GENERAL NOTES:**

1. DRAWING SCALE AS NOTED. WRITTEN DIMENSIONS SHALL TAKE PRECEDENCE OVER SCALED DIMENSIONS.
2. THIS IS NOT A BOUNDARY SURVEY. BOUNDARY INFORMATION DEPICTED HAS BEEN OBTAINED FROM HUMBOLDT COUNTY 2015 GIS DATA. NORTHPOINT CONSULTING GROUP, INC. HAS NOT VERIFIED THIS PROPERTY BOUNDARY.
3. ANY EXISTING DEVELOPMENT CONSTRUCTED WITHOUT THE BENEFIT OF COUNTY REVIEW WILL BE SUBJECT TO THE HUMBOLDT COUNTY BUILDING DEPARTMENT UPON APPROVAL OF THE CONDITIONAL USE PERMIT.
4. CLASSIFICATION OF WATERCOURSES AS IDENTIFIED IN TIMBERLAND RESOURCE CONSULTANTS WATER RESOURCES PROTECTION PLAN.

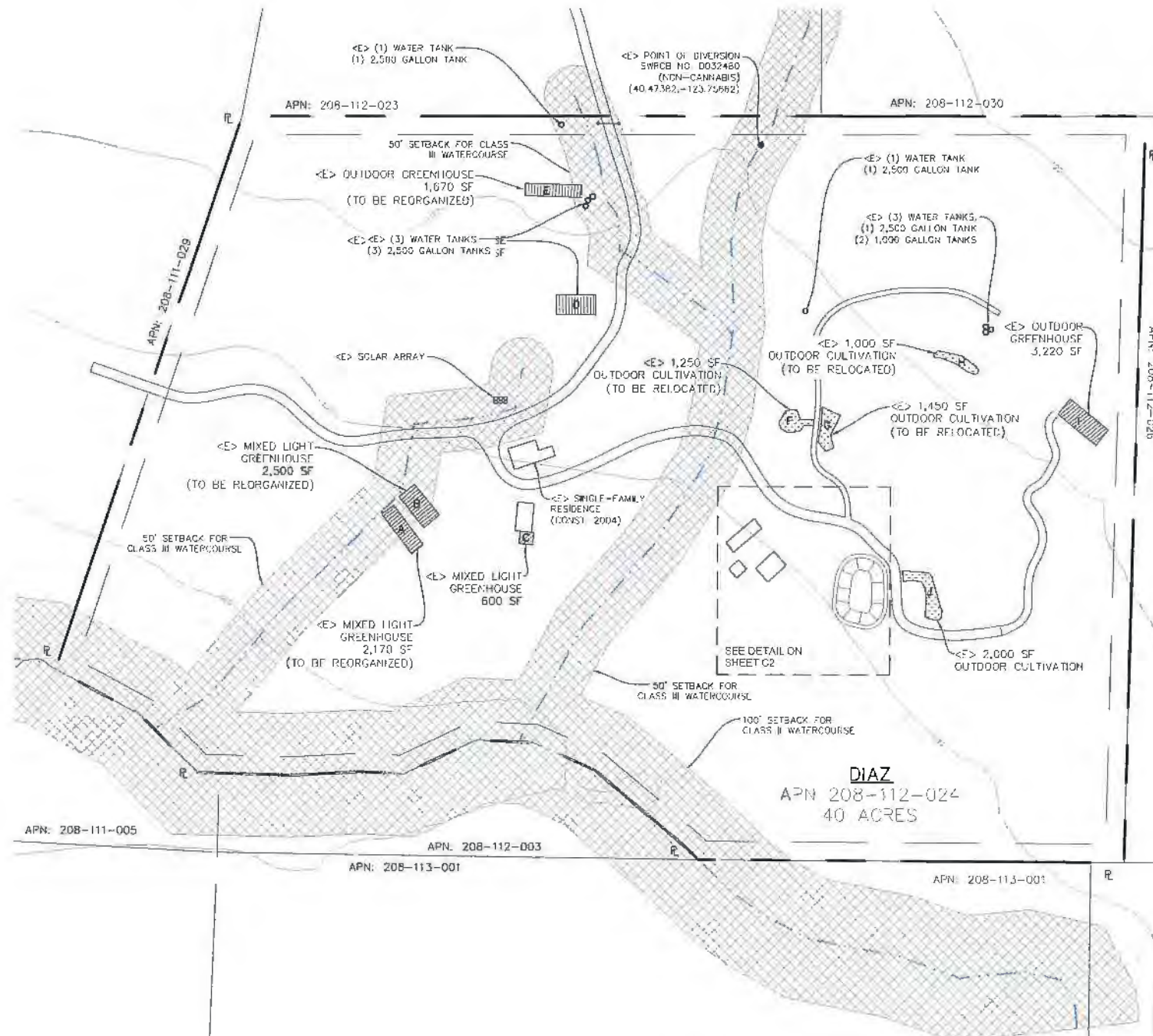

**PROJECT INFORMATION:**

**APPLICANT:**  
 SUNNY SLOPE RANCH LLC  
 26980 STATE HIGHWAY 36  
 BRIDGEVILLE, CA 95528

**PROPERTY OWNER:**  
 THADEUS DIAZ  
 369 CHURCH LANE  
 CARLOTTA, CA 95528

**OWNERS AGENT:**  
 NORTHPOINT CONSULTING GROUP INC.  
 317 3RD STREET - SUITE 15  
 EUREKA, CA 95501  
 (707) 798-6438

**SITE ADDRESS:**  
 APN: 208-112-024  
 26980 STATE HIGHWAY 36  
 BRIDGEVILLE, CA 95528

**TREES TO BE REMOVED:** = 0  
**EARTHWORK QUANTITIES:** = TBD  
**WATER:** = PRIVATE  
**SEWER:** = PRIVATE  
**PARCEL SIZE:** = 40 ACRES  
**ZONING:** = FR-B-5(40)  
**GENERAL PLAN DESIGNATION:** = AL40 (FRWK)

**SRA AREA:** = YES  
**IN COASTAL ZONE:** = NO  
**IN 100 YR FLOOD ZONE:** = NO

**BUILDING SETBACKS:**

	AC	TPZ	SRA
FRONT	30'	20'	30'
SIDE	20'	30'	30'
REAR	10'	30'	30'

**MAX BLDG. HT.:** = NONE SPECIFIED  
**MAX GROUND COVERAGE:** = 35%



**PLOT PLAN**

22x34 SHEET: 1"=120'  
 11x17 SHEET: 1"=240'

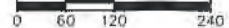

**SHEET INDEX:**

- C0 - SITE OVERVIEW
- C1 - SITE BPTCS
- C2 - PROCESSING PLAN

**NORTHPOINT**  
 CONSULTING GROUP, INC.  
 317 3rd Street, Ste. 15 Eureka, CA 95501

SUNNY SLOPE RANCH, LLC / APN: 208-112-024  
 26980 STATE HIGHWAY 36, BRIDGEVILLE, CA 95528  
 SITE MANAGEMENT PLAN - SITE OVERVIEW

PROJ. NO.: EJ  
 DRAWING NO.: P.A.  
 DATE: 4/15/2019  
 SCALE: AS SHOWN

SHEET  
**C0**

April 15, 2019 11:46 AM C:\Users\james\OneDrive\Documents\2019\11\2019-04-15\2019-04-15-11-46-AM\2019-04-15-11-46-AM.dwg - 2019-04-15 11:46 AM - 11:46 AM - 11:46 AM - 11:46 AM - 11:46 AM - 11:46 AM - 11:46 AM - 11:46 AM - 11:46 AM - 11:46 AM

# SUNNY SLOPE RANCH, LLC SITE MANAGEMENT PLAN (SMP)

SITE BPTC'S  
APN: 208-112-024

LEGEND	
	ROLLING DIP
	STREAM CROSSING
	PROPOSED
	EXISTING
	OUTSLOPE
	INSLOPE
	CRITICAL DIP
	ROCKED SECTION OF ROAD
	ROCK CHECK DAM

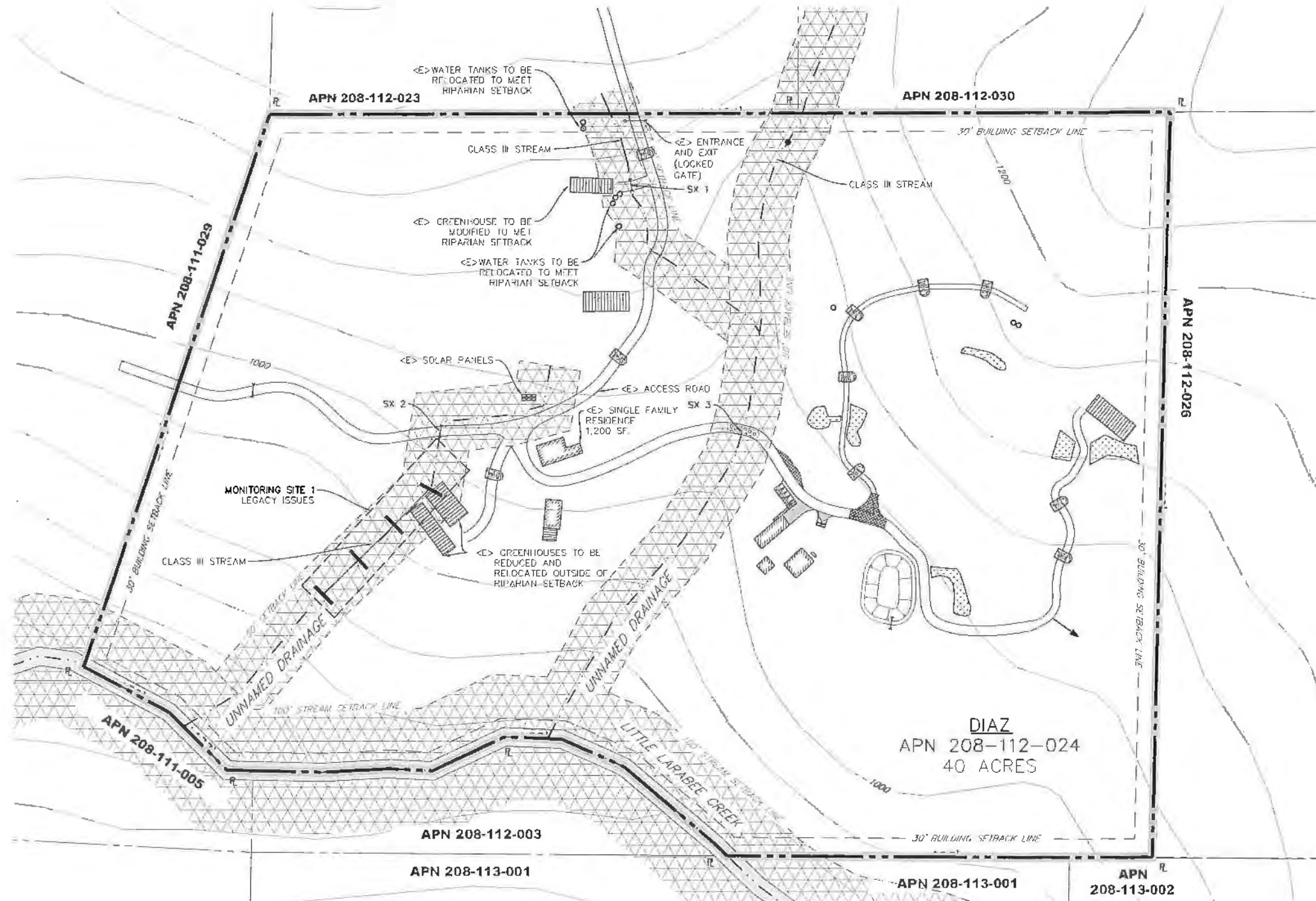

### PLOT PLAN

22x34 SHEET: 1"=100'  
11x17 SHEET: 1"=200'

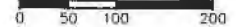

PROJECT	
DATE	



SUNNY SLOPE RANCH, LLC/APN:208-112-024  
STATE HIGHWAY 36, BRIDGEVILLE, CA 95528  
SITE BPTC'S

PROJ. NO.	HJ
CLIENT	V.D.S.
DATE	7/13/2018
SCALE	AS SHOWN
SHEET	<b>C2</b>

JUN 28, 2018 - 10:25 AM - Doc Name: P:\18-062 - 03-2018 - Sunny Slope Ranch, LLC\2018\062\180713\_SMP\_C2.dwg - User: J. Hernandez - Title: 2018-062 - 03-2018 - Sunny Slope Ranch, LLC\2018\062\180713\_SMP\_C2.dwg - User: J. Hernandez - Title: 2018-062 - 03-2018 - Sunny Slope Ranch, LLC\2018\062\180713\_SMP\_C2.dwg





## Appendix B: Disturbed Area Map



# Sunny Slope Ranch, LLC

Thadeus Diaz  
APN: 208-112-024

Total Disturbed Area (sf): 35,386  
Total Disturbed Area (ac): 0.81

## Legend

- Mixed Light Cultivation - 5,270 sf
- Outdoor Cultivation - 16,390 sf
- Rainwater Catchment Pond - 7,300 sf
- Soil, Veg, and Burn Pile - 800 sf
- Structures - 5,270
- Water Storage Tanks - 356 sf



Google Earth

© 2018 Google

700 ft

# Appendix C: BPTC Implementation and Maintenance Schedule



**CULTIVATION ACTIVITIES SCHEDULE**

**BPTC IMPLEMENTATION & MAINTENANCE SCHEDULE**

Type			Measures	Jan	Feb	Mar	Apr	May	Jun	Jul	Aug	Sep	Oct	Nov	Dec	
EROSION PREVENTION	Physical	Runoff Management	Diversions - Perimeter Dikes, Swale, Check Dams, Water Bars, Rolling Dips Conveyance - Lined Waterway, Grade Stabilization Structures	█												
		Soil Stabilization	Non-Vegetative Soil Cover - Mulching, Soil Tackifiers, Slope Protection, Riprap, Fiber Rolls and other Rolled Erosion Control Products (RECP), Plastic Cover, Surface Roughening				█									
		Structural	Retaining Wall, Sediment Basins/Traps, Silt Fences; Armoring and Velocity Dissipators; Inlet, Outlet, and Streambank Protection/Stabilization						█							
	Biological	Runoff Management	Diversion/Conveyance - Grassed Waterway	█												
		Soil Stabilization	Temporary/Permanent Seeding, Hydroseeding, Topsoiling, Live Mulching, Vegetation Preservation/Replacement			█										
		Biotechnical	Biotechnical - Wattling, Brush Layering, Branch Packing, Live Cribwalls, Live Fascines, Live Plantings, Vegetated Streambank Protection, Vegetated Gabions		█											
SEDIMENT CONTROL	Physical	Runoff Management	Sediment Conveyance - Lined Drainageways	█												
		Sediment Retention	Sediment Basins/Traps - Pipe Outlet Traps, Embankment and Debris Basins, Settling Ponds, Rock Dams			█										
		Sediment Barriers	Straw Bale Dikes, Drain Inlet Filters, Gravel Bag Berms, Fiber Rolls, Silt Fences, Turbidity Curtain				█									
		Mud and Dust Control	Construction Entrance and Road Stabilization, Dust Control, Waterway Crossing				█									
	Biological	Soil Stabilization	Hydroseeding, Vegetated Outfalls			█										
INTERIM EROSION & SEDIMENT CONTROL MEASURES			Installed and Maintained as Needed	█												



## CULTIVATION ACTIVITIES SCHEDULE

Highlight or check off the months when the following activities will take place.

### BPTC IMPLEMENTATION & MAINTENANCE SCHEDULE

Type			Measures	Jan	Feb	Mar	Apr	May	Jun	Jul	Aug	Sep	Oct	Nov	Dec		
EROSION PREVENTION	Physical	Runoff Management	Diversions - Perimeter Dikes, Swale, Check Dams, Water Bars, Rolling Dips Conveyance - Lined Waterway, Grade Stabilization Structures														
		Soil Stabilization	Non-Vegetative Soil Cover - Mulching, Soil Tackifiers, Slope Protection, Riprap, Fiber Rolls and other Rolled Erosion Control Products (RECP), Plastic Cover, Surface Roughening														
		Structural	Retaining Wall, Sediment Basins/Traps, Silt Fences; Armoring and Velocity Dissipators; Inlet, Outlet, and Streambank Protection/Stabilization														
	Biological	Runoff Management	Diversion/Conveyance - Grassed Waterway														
		Soil Stabilization	Temporary/Permanent Seeding, Hydroseeding, Topsoiling, Live Mulching, Vegetation Preservation/Replacement														
		Biotechnical	Biotechnical - Wattling, Brush Layering, Branch Packing, Live Cribwalls, Live Fascines, Live Plantings, Vegetated Streambank Protection, Vegetated Gabions														
SEDIMENT CONTROL	Physical	Runoff Management	Sediment Conveyance - Lined Drainageways														
		Sediment Retention	Sediment Basins/Traps - Pipe Outlet Traps, Embankment and Debris Basins, Settling Ponds, Rock Dams														
		Sediment Barriers	Straw Bale Dikes, Drain Inlet Filters, Gravel Bag Berms, Fiber Rolls, Silt Fences, Turbidity Curtain														
		Mud and Dust Control	Construction Entrance and Road Stabilization, Dust Control, Waterway Crossing														
	Biological	Soil Stabilization	Hydroseeding, Vegetated Outfalls														
INTERIM EROSION & SEDIMENT CONTROL MEASURES			Installed and Maintained as Needed														

# Appendix D: BPTC Measure Specifications



## **Table of Contents**

- RD1.1 Modified Low Water Rock Ford
- RD1.2 Fords
- RD1.3 Outsloped Roads w/ Inboard Swale
- RD1.4 Outsloped Road
- RD1.5 Inslope Road
- RD1.6 Thru Cut Road
- RD1.7 Critical Dips
- RD1.8 Rolling Dip
- RD1.9 Grading Unpaved Road Surfaces
- RD1.10 Water Bars
- RD1.11 Ditch Relief Culverts (DRC)
- RD1.12 Stream Crossing Installation
- RD1.13 Drainage for Unpaved Roads
- RD1.14 Road Surface Upgrade
- RD1.15 Routing and Location
- RD1.16 Understanding Road Removal
- RD1.17 Road Closure
- EC1.1 Jute Mat Blanket
- EC1.2 Culvert Outlet Energy Dissipater
- EC1.3 Outlet Protection
- EC1.4 Stockpile Management
- SS-6 Straw and Mulch
- SS-7 Geotextiles, Mats, Plastic Covers, and Erosion Control Blankets
- SS-10 Outlet Protection
- SS-11 Slope Drains
- SC1.1 Check Dams
- SC1.2 Sediment Basin
- SC1.3 Fiber Rolls
- Road BMP Resources



# RD-1.1 MODIFIED LOW WATER ROCK FORD

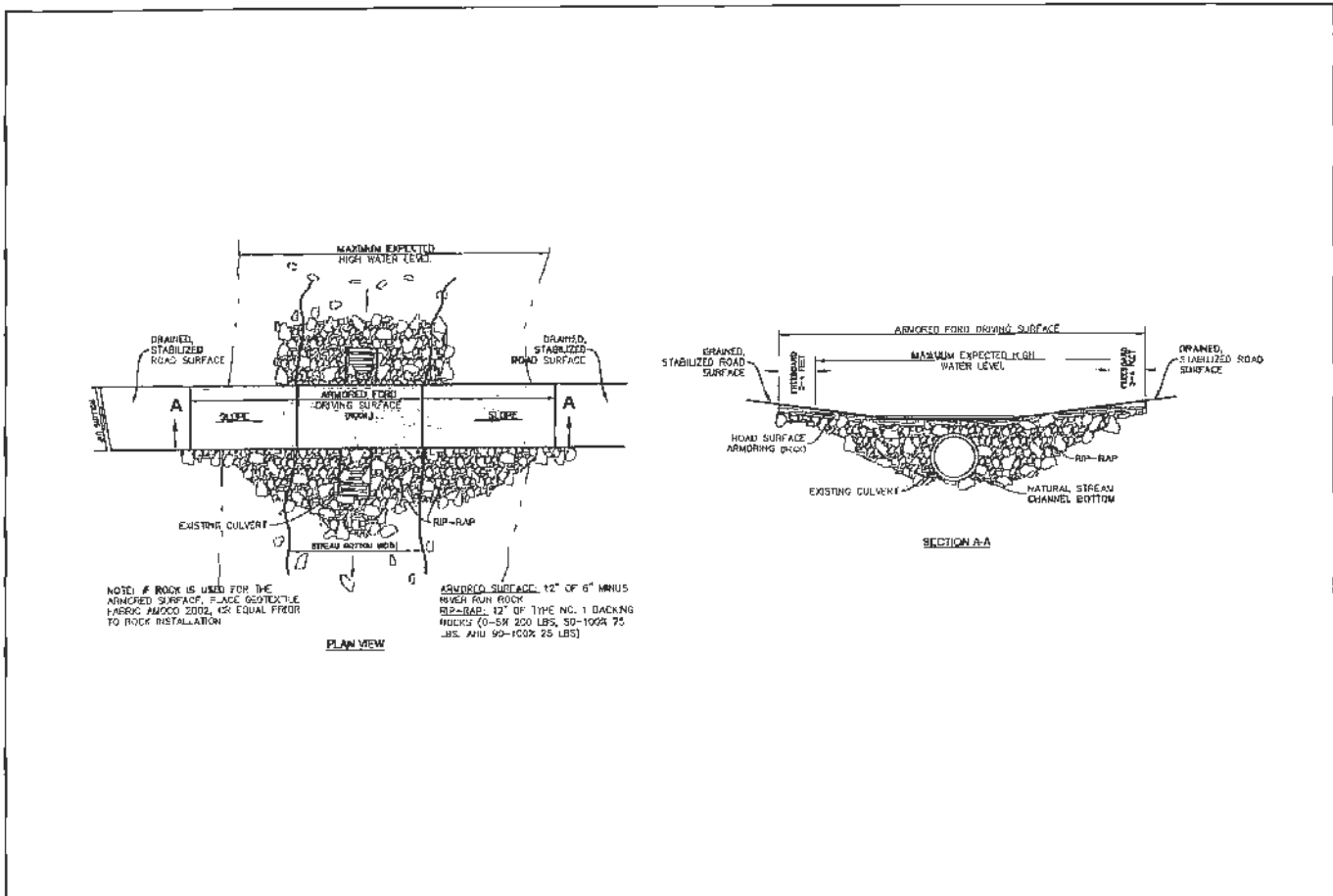

WATER RESOURCE PROTECTION PLAN (WRPP) – NorthPoint Consulting

## RD-1.2 FORDS

### DESCRIPTION

Fords work well on small to medium sized streams where there is a stable stream bottom and traffic is light. However, "construction" of fords and other unimproved stream crossings on well traveled roads should be avoided where water is flowing because of their potential to impact water quality. In certain situations, where flash floods, high seasonal flood peaks or floating debris are problems, fords may be a practical answer for crossing a poorly incised, shallow stream.

### BEST MANAGEMENT PRACTICES

- Fords in flowing streams, called "wet fords," are typically composed of streambed gravels, fill, or concrete structures built in contact with the streambed so that vehicles can cross the channel (Figure 1).
- Fords should be designed to allow low summer flows seep through the fill, and high water discharges flow over the top (Figure 2).
- Paving fords across flowing streams may be necessary to maintain water quality if there is to be regular traffic. Paving consists of a concrete, slightly dish-shaped slab across the watercourse, and a discharge apron or energy dissipater on the downstream side to prevent scour during high flows.
- On small, poorly incised, ephemeral or intermittent streams a ford may be needed if there is insufficient channel depth to install a culvert. In fact, a rock lined rolling dip with a rock apron face is generally desirable to permanent culverts on these swales and small watercourses. Fords have the advantage, over culverted fills, of never plugging.
- Fords on small streams should be rock armored to prevent erosion of the road surface and fill during periods of runoff. The fill face on the downstream side of the fill can either be protected with rock armor or fitted with a large overside drain (berm drain) to prevent erosion (Figure 3).
- Unimproved fords, which consist of a stream channel that has been filled with a substantial quantity of soil and left unprotected by armor or surfacing is a hazard to water quality and should not be constructed.

*Figure 1. Wet ford on Class II perennial stream. Clean rock aggregate has been imported for the travelling surface and coarse rock armor protects the outer edge of the road bed. It is important that rock aggregate used in a ford be large enough to resist transport during winter flows. Fords should not be used if high winter flows would cut off access to inspect and maintain drainage structures further out the road. From Weaver and Hugans (1994).*

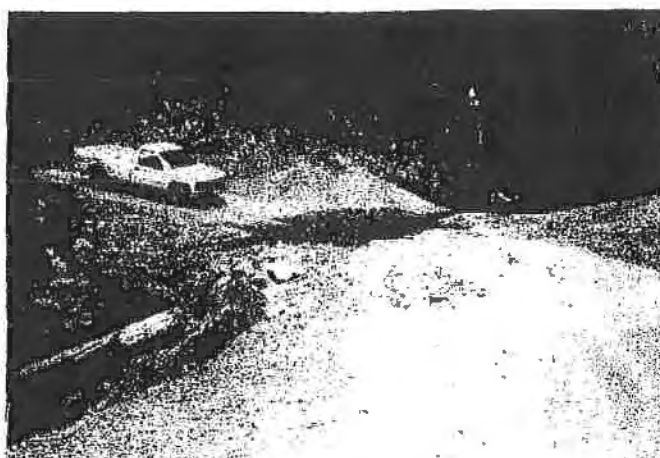

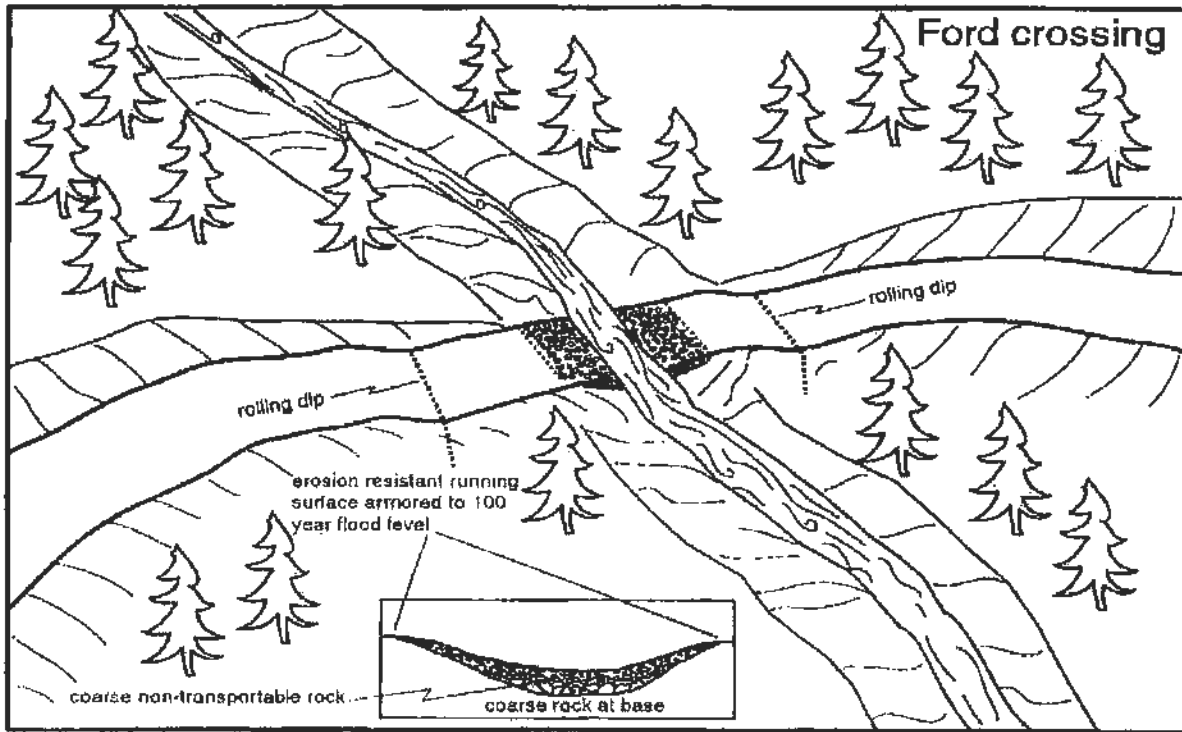

Figure 2. Typical ford stream crossing. From CDFG (2006).

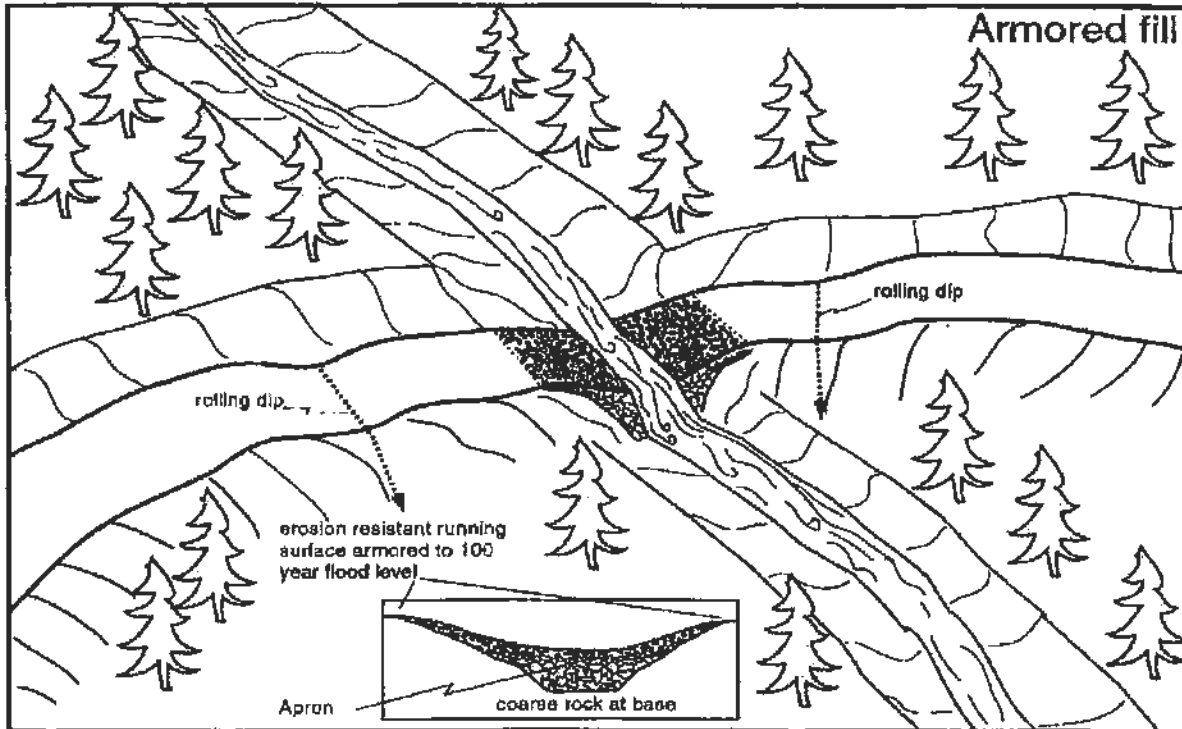

Figure 3. Typical armored stream crossing. From CDFG (2006).

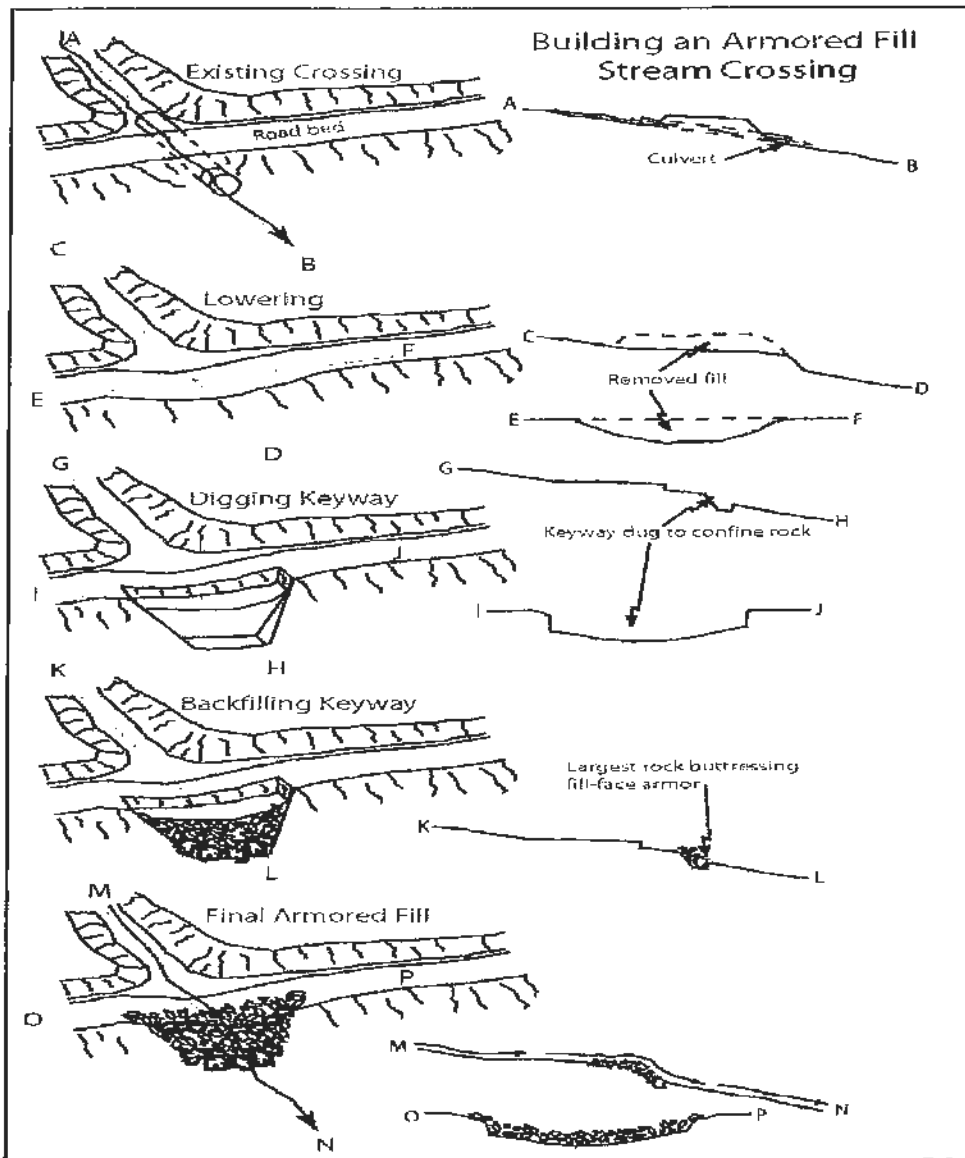

Figure 4. Design elements of a typical armored fill crossing. Note: where geotextile fabric may interfere with passage of amphibians in any Class 2 or 3 crossing, bury geotextile fabric with at least 6 inches of rock. Do not expose geotextile fabric in the bed of fish-bearing stream channels. From CDFG (2206).

**Source Material for Road BMP RD-2.7 Fords**

2006. California Department of Fish and Game. Part X - Upslope Erosion Inventory and Sediment Control Guidance, California Salmonid Stream Habitat Restoration Manual.

1994. Weaver W.E. and D.K. Hagans. Handbook for Forest and Ranch Roads. Mendocino County Resource Conservation District

# RD-1.3 OUTSLOPED ROAD W/ INBOARD SWALE

NOTE: ALL ROAD WIDTHS TO BE 12' MINIMUM AND ROCKED/REINFORCED WITH 2" MINIMUM AGG. BASE FROM ON SITE SOURCE

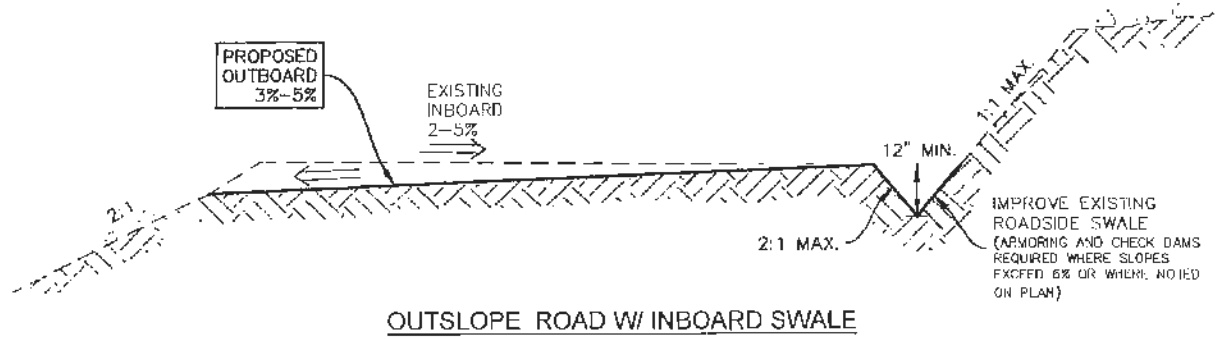

WATER RESOURCE PROTECTION PLAN (WRPP) - NorthPoint Consulting

# RD-1.4 OUTSLOPED ROAD

NOTE: ALL ROAD WIDTHS  
TO BE 12' MINIMUM AND  
ROCKED/REINFORCED WITH  
2" MINIMUM AGG. BASE  
FROM ON SITE SOURCE

NOTE: ALL ROAD WIDTHS  
TO BE 12' MINIMUM

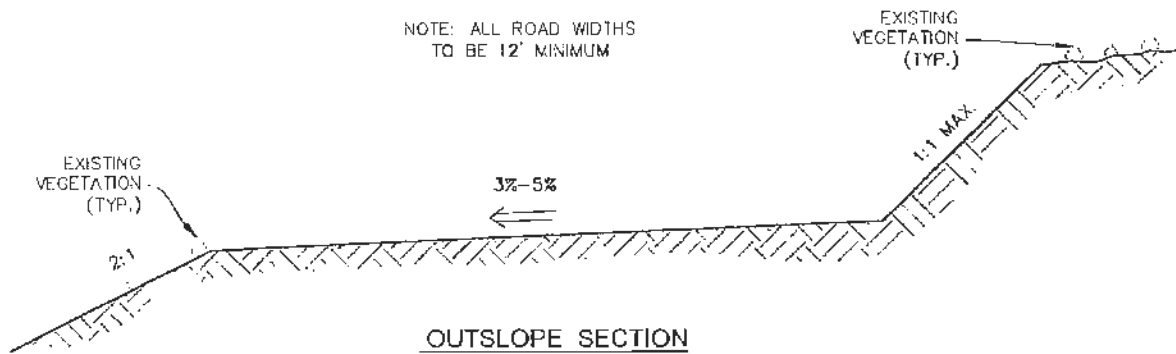

WATER RESOURCE PROTECTION PLAN (WRPP) — NorthPoint Consulting

# RD-1.5 INSLOPE ROAD

NOTE: ALL ROAD WIDTHS  
TO BE 12' MINIMUM AND  
ROCKED/REINFORCED WITH  
2" MINIMUM AGG. BASE  
FROM ON SITE SOURCE

NOTE: ALL ROAD WIDTHS  
TO BE 12' MINIMUM

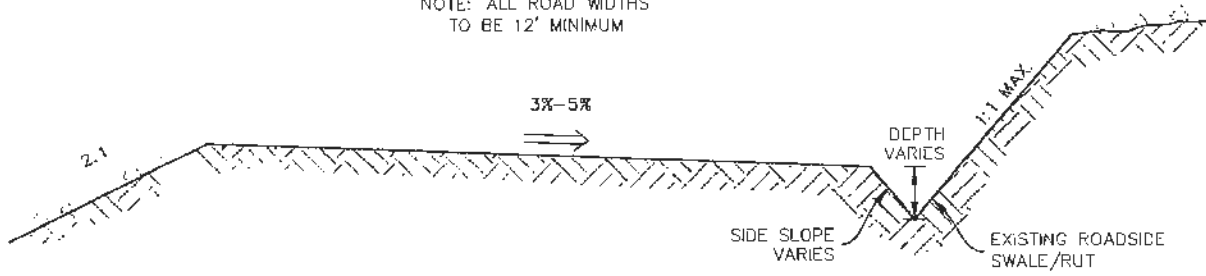

INSLOPE SECTION

WATER RESOURCE PROTECTION PLAN (WRPP) – *NorthPoint Consulting*

# RD-1.6 THRU CUT ROAD

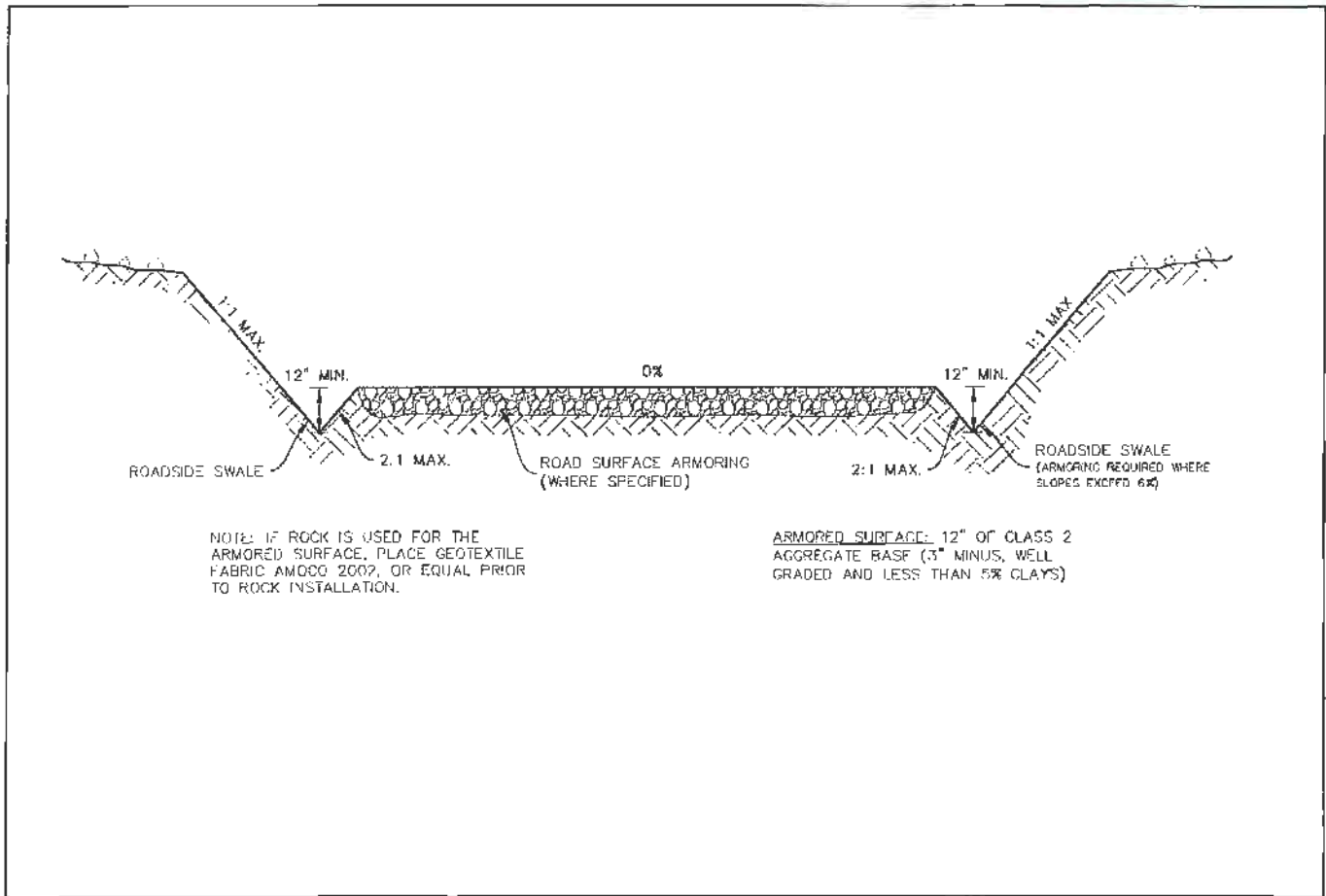

WATER RESOURCE PROTECTION PLAN (WRPP) – NorthPoint Consulting



## RD-1.7 CRITICAL DIPS

### DESCRIPTION

A critical dip is a rolling dip constructed on or close to the down-road hinge-line of a stream crossing, displaying a diversion potential. Build a critical dip at all stream crossings in order to prevent stream diversions when a culvert plugs and water flows out onto the road. Construction may be similar to Road BMP RD-1.8 Rolling Dips.

### BEST MANAGEMENT PRACTICES

- Stream crossings should be constructed to prevent diversion of flood overflow if the culvert were to become plugged. This can be done by designing the road to dip into and out of the stream at the crossing site or by installing a broad rolling dip on the down-road side of the crossing. This will allow the overflow to be directed back into the natural stream channel (Figure 1).
- Critical dips should be designed to handle the 100-year flow event for the stream it is installed at.
- Road surface and fill slopes at the critical dip should be rocked or otherwise stabilized.
- Must be deep enough that it is not obliterated by normal grading, but not so deep that it is difficult to negotiate or a hazard to normal traffic (Table 1).
- See Road BMP RD-1.8 Rolling Dips for more details.

Road grade %	Upslope approach (distance from up-road start of rolling dip to trough) (ft)	Reverse grade (distance from trough to crest) (ft)	Depth below average road grade at discharge end of trough (ft)	Depth below average road grade at upslope end of trough (ft)
<6	55	15-20	0.9	0.3
8	65	15-20	1.0	0.2
10	75	15-20	1.1	.01
12	85	20-25	1.2	.01
>12	100	20-25	1.3	.01

Table 1. Table of rolling dips dimensions. Design principles apply to critical dip. From CDFG (2006).

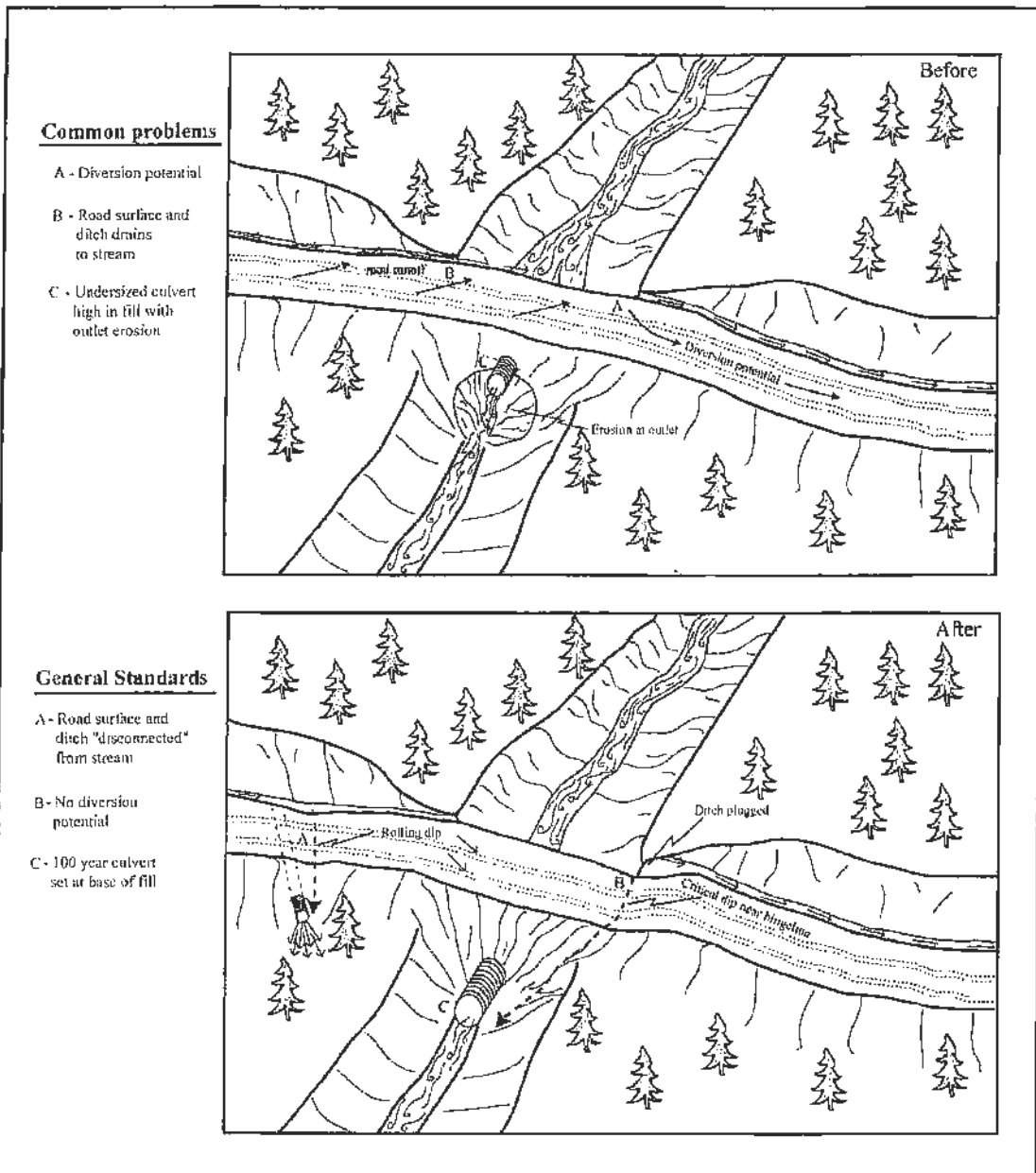

Figure 1. Install critical dips to prevent diversion prevention at stream crossings. Critical dips should be designed to handle the flow from a 100-year storm event. From CDFG (2006).

**Source Material for Road BMP 2.9 Critical Dips**

2006. California Department of Fish and Game. Part X - Upslope Erosion Inventory and Sediment Control Guidance, California Salmonid Stream Habitat Restoration Manual.

2004. FishNet 4C. Guidelines for Protecting Aquatic Habitat and Salmon Fisheries for County Road Maintenance.

# RD-1.8 ROLLING DIP

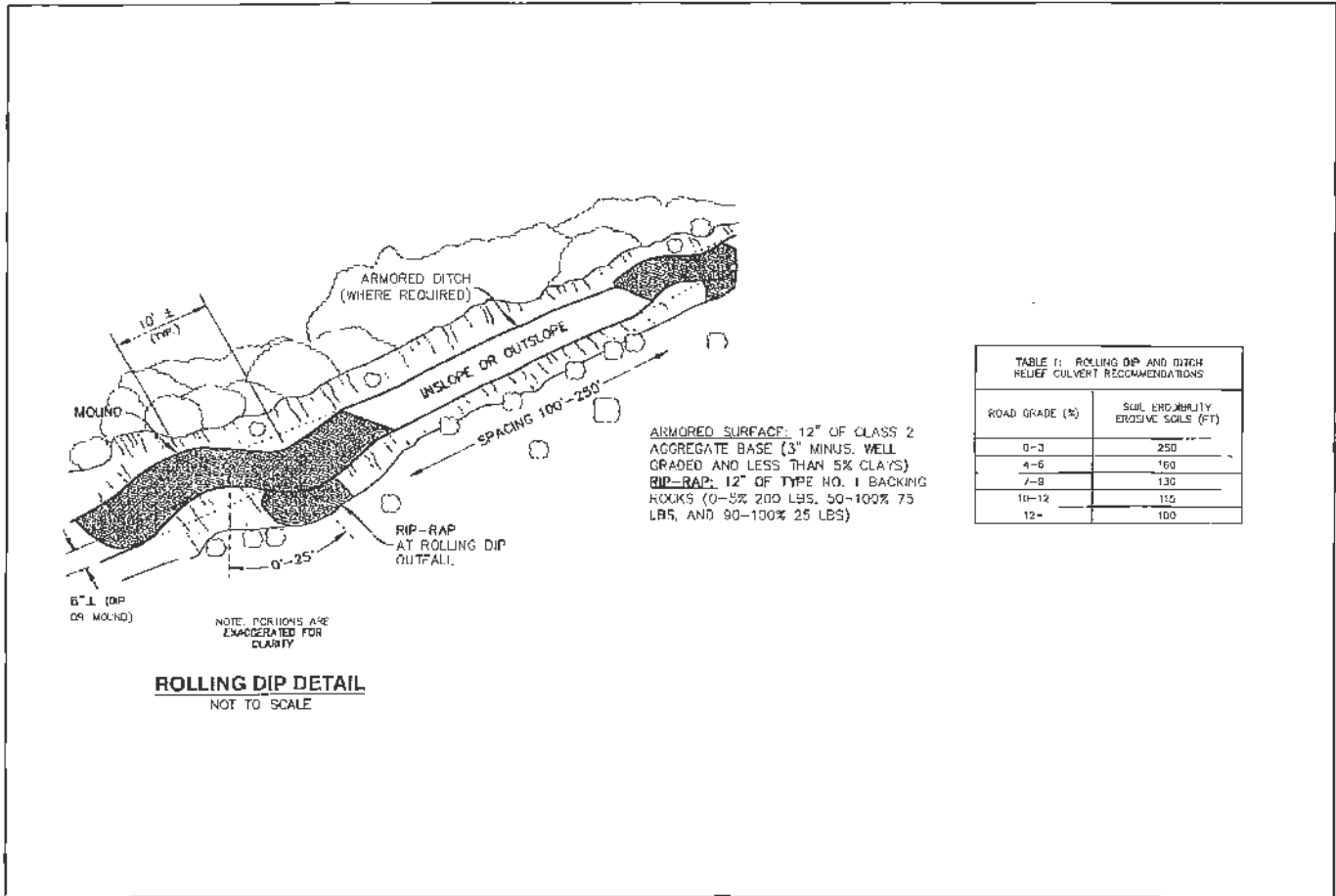

WATER RESOURCE PROTECTION PLAN (WRPP) — NorthPoint Consulting

## **RD-1.9 GRADING UNPAVED ROAD SURFACES**

### **DESCRIPTION**

Good maintenance practices on unpaved road surfaces prevent roadway erosion, deterioration or failure; helps with sediment and dust control, and provides a safe roadway surface for the traveling public.

### **BEST MANAGEMENT PRACTICES**

- Fit grading to the surrounding terrain.
- Blade and compact a smooth surface and compact loose soils as needed.
- Crown or slope the road to avoid ponding or concentration of runoff. Outslope all roads where possible and safe.
- Preserve existing vegetation to the greatest extent feasible.
- Minimize the length and steepness of slopes.
- Maintain natural drainage patterns in watershed.
- Preserve or improve surface drainage in the vicinity of the road.
- Disconnect road drainage features from watershed hydrology.
- Make sure drainage is self-maintaining.
- Keep runoff velocities low, using energy dissipating control measures.
- Minimize amount of road-related sediment that gets into watercourses.
- Prevent dust abatement chemicals from getting into watercourses or riparian areas.

### **SEASONAL CONCERNS**

- Perform routine road surface maintenance during the dry season. Avoid working in wet conditions and during the wet season (October 15- April 15), except for emergencies. Disturbed soil combined with rainfall, greatly increase the risk of exposed sediment runoff into streams.
- Inspect roads and associated drainage facilities for signs of erosion or deterioration at least twice annually with at least one inspection during or after first storm events of the season with additional follow-up for severe storm events. Inspect all road and drainage facilities after a large storm event. Note locations of road surfaces, drainage features, cutslopes and fillslopes that appear to be failing and contributing sediment to streams in order to prioritize maintenance or repair.

**SPOILS AND SIDECASTING**

- Avoid sidecasting of soil in all cases where it could be delivered into a watercourse, riparian area, roadside ditch or storm drain. In some instances, under the following guidelines (Table 1), sidecasting is allowable given remote distances from spoils storage sites. In these cases, the setback distance required depends on slope and vegetation. The presence of vegetation helps to slow the travel of sediment downslope, so good judgment is needed to assess the situation. *Do not sidecast at all* if the slope is sparsely vegetated and it appears that sediment will travel with rain runoff into a stream or estuary system, even if setback distances are applied. On slopes of 5:1 (20% gradient) or less, sidecasting is allowed beyond 150 feet of a watercourse, stream crossing, riparian area, roadside ditch or storm drain. On 2:1 slopes (50%) or less, sidecasting is allowed beyond 300 feet of a watercourse, stream crossing, riparian area, roadside ditch or storm drain. On slopes greater than 2:1, typically sidecasting is *not recommended*, however there may be rare instances on slopes greater than 2:1 where sidecasting is acceptable given very long distances from waterbodies and good vegetative cover. Seek advice from local fisheries agency staff when in doubt. Avoid concentrating sidecasting repeatedly in the same place. Never sidecast large amounts of soil from major landslides.
- Temporary spoils stockpiles should be located in areas that are relatively level; relatively free of vegetation and away from streams and wetlands areas (see Erosion Control BMP EC-1.5 Stockpile Management). The primary concern is to keep stockpiled materials from eroding into stream or wetland systems. Apply erosion control BMPs when needed. Do not place temporary spoils piles at the top of unstable slopes or at the edges of slopes where water will carry sediment into watercourses. Remove temporary stockpiles to permanent disposal locations before the rainy season. If emergency work is conducted during the rainy season, remove stockpile as soon as feasible and before the next rain storm.

<b>SLOPE GRADIENT</b>	<b>DISTANCE FROM WATERCOURSE, STREAM CROSSING, RIPARIAN AREA, ROADSIDE DITCH, STORM DRAIN</b>	<b>SIDECASTING RULE</b>
Any slope	Appears that sediment will travel with rainwater into watercourse.	Not allowed
5:1 (20%) or less	150 feet or more	Allowed using good judgment
2:1 (50%) or less	300 feet or more	Allowed using good judgment
Greater than 5:1 (50%)	Vegetated slope long distance from watercourse	Allowed
Greater than 5:1 (50%)	Sparsely vegetated slope and it appears that sediment will travel with rain into watercourse	Not allowed

Table 1. Sidecasting guidelines. From. FishNet 4C (2004)

**BERMS**

- Do not leave loose soil piled in berms alongside the road or ditch. Loose or exposed soil berms are erodible and readily flushed into waterways and storm drains.
- If any berm is left in place for public safety reasons it must be compacted and stabilized with seeding or asphalt. Frequent well placed breaks in the berms are necessary to allow water to drain from road, preserving the natural drainage pattern of the slope.

**Source Material for Road BMP RD-3.2 Grading**

2004. FishNet 4C. Guidelines for Protecting Aquatic Habitat and Salmon Fisheries for County Road Maintenance.

2002. Five Counties Salmon Conservation Program. A Water Quality and Stream Habitat Protection Manual for County Road Maintenance.

**RD-1.10 WATERBARS**

**DESCRIPTION**

Waterbars are shallow, abrupt excavated dips or troughs with an adjacent, downslope hump or mounded berm, that are built at an oblique angle across the road (Figure 1 and 2). Waterbars are useful only on low standard seasonal or temporary, unsurfaced roads where winter use will not occur, because traffic easily cuts through the soft berm and fills the adjacent dip. Waterbars should be constructed at proper spacing according to the grade of the road (Table 3). Waterbars are usually regraded (smoothed out) at the beginning of each operating season, and then reconstructed at the beginning of each winter period.

Waterbars are high maintenance drainage structures that are prone to failure if not properly built and maintained. Unauthorized winter traffic is likely to break down waterbars and result in serious road surface erosion and water pollution.

**BEST MANAGEMENT PRACTICES**

- Waterbars and rolling dips should be spaced along the road close enough together that the road surface is not gullied (Table 3). Appropriate spacing of surface drainage structures depends on soil credibility and runoff rates. Look at local roads to determine the maximum spacing that will work in your specific area.

<b>Table 3. Maximum distance between waterbreaks on roads and trails (feet)<sup>1</sup></b>				
<b>Erosion Hazard Rating (for surface erosion)</b>	<b>Road or Trail Gradient (%)</b>			
	<b>10% or less</b>	<b>11-25%</b>	<b>26-50%</b>	<b>over 50%</b>
<b>Extremely high</b>	100'	75'	50'	50'
<b>High</b>	150'	100'	75'	50'
<b>Moderate</b>	200'	150'	100'	75'
<b>Low</b>	300'	200'	150'	100'

Table 3. From Weaver and Hagans (1994). <sup>1</sup> Adapted from California Forest Practice Rules. This is the maximum distance between waterbars: when in doubt, reduce the spacing. Soils are nonrenewable and waterbars are inexpensive.

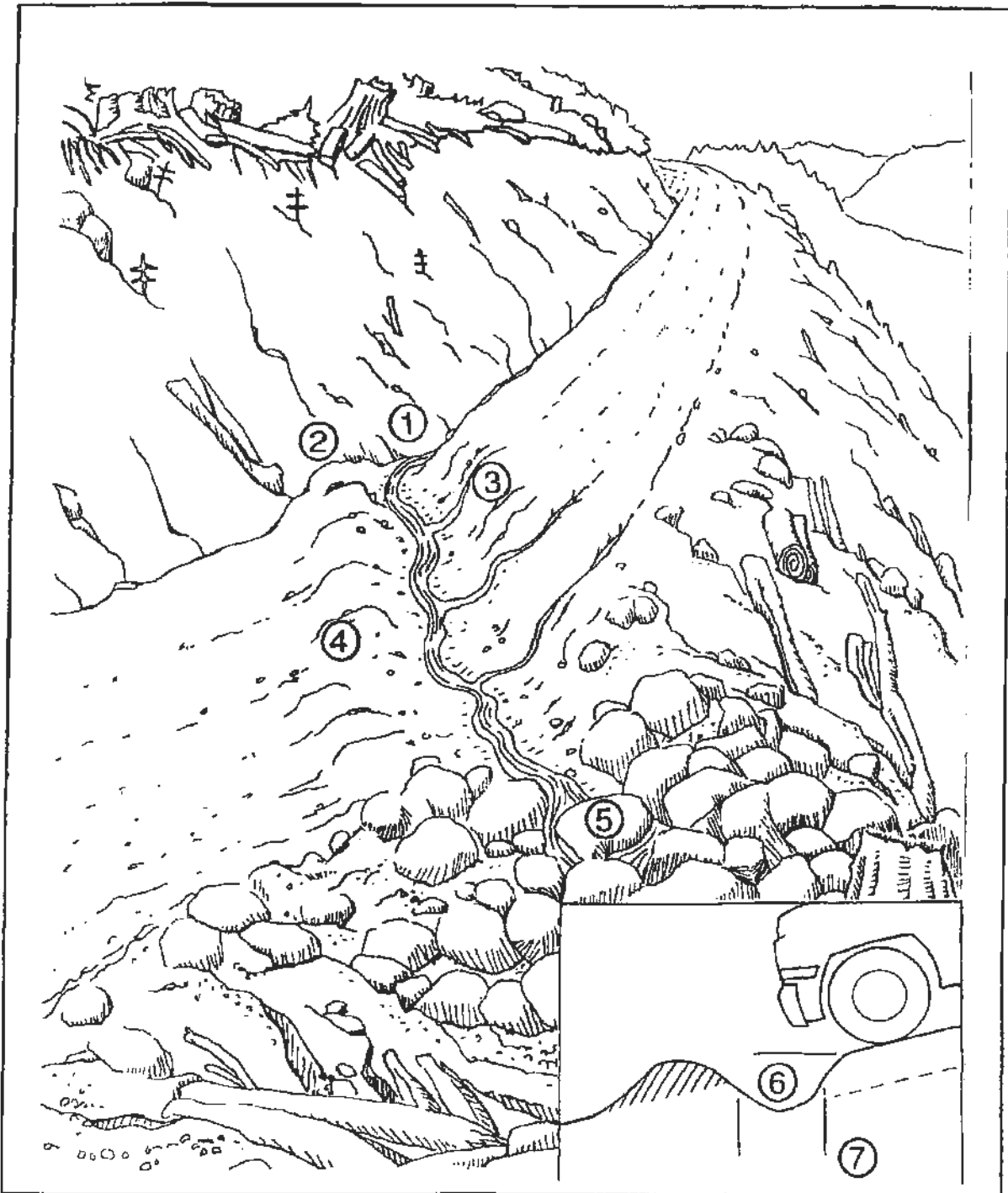

Figure 1. Waterbars are constructed on unsurfaced forest and ranch roads that will have little or no traffic during the wet winter period. The waterbar should be extended to the cutbank to intercept all ditch flow (1) and extend beyond the shoulder of the road. A berm (2) must block and prevent ditch flow from continuing down the road during flood flows. The excavated waterbar (3) should be skewed 30° to the ditch-line with the excavated material bermed on the downhill grade of the road (4). Water should always be discharged onto the downhill side on a stable slope protected by rip rap or vegetation (5). The cross ditch depth (6)



and width (7) must allow vehicle cross-over without destroying the function of the drain (B.C.M.F., 1991). From Weaver and Hagans (1994).

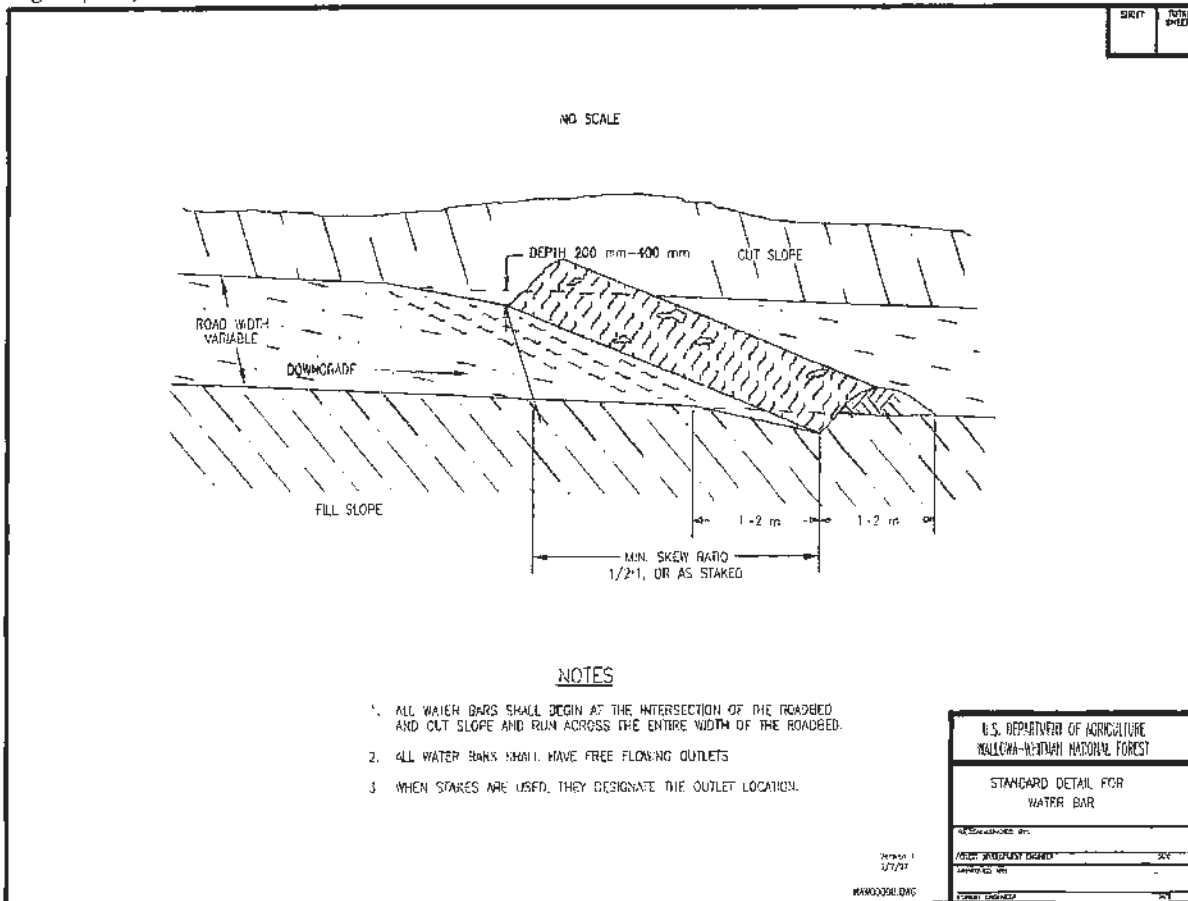

Figure 2. Typical design of a waterbar. From US Forest Service.

**Source Material for Road BMP RD-7.8 Waterbars**

1994, Weaver W.E. and D.K. Hagans. Handbook for Forest and Ranch Roads. Mendocino County Resource Conservation District

## **RD-1.11 DITCH RELIEF CULVERT** **INSTALLATION**

### **DESCRIPTION**

Ditch relief culverts (DRCs) divert water from an inside road ditch to an outside area beyond the outer edge of the road fill. DRCs take the flow through or beneath the road surface. Ditch relief culverts may also be used to filter water in a buffer zone prior to entering a waterway.

### **BEST MANAGEMENT PRACTICES**

- Culverts should be designed and installed at intervals along the road that are close enough to prevent erosion of the ditch and at the culvert outfall, and at locations where collected water and sediment is not discharged directly into watercourses (Table 1).
- Install ditch relief culverts at an oblique (typically 30 degree) angle to the road so that ditch flow does not have to make a sharp angle turn to enter the pipe (Figure 1). On low gradient roads (<5%), where ditch flow is slow, ditch relief culverts can be installed at right angles to the road.
- Ditches should *neither* be discharged directly into the inlet of a watercourse crossing culvert, nor should ditch relief culverts discharge into a watercourse via surface flow without first directing flow through an adequate filter strip (Figure 2).
- In addition to installing ditch relief culverts on either approach to watercourse crossings, it is also advisable to consider installing ditch drains before curves, above and below through-cut road sections, and before and after steep sections of the road.
- If the ditch is on an insloped or crowned road that is very close to a stream, consider using outsloping to drain the road surface (see Road BMP RD-1.3, 1.4 Outslope Road). The ditch and the ditch relief culvert would then convey only spring flow from the cutbank, and not turbid runoff from the road surface.
- Do not discharge flow from ditch relief culverts onto unstable or highly erodible hillslopes
- Culverts should be installed at the gradient of the original ground slope, so it will emerge on the ground surface beyond the base of the fill. If not, either the fill below the culvert outlet should be armored with rock, or the culvert should be fitted with an anchored downspout to carry erosive flow past the base of the fill (Figure 1).
- Downspouts longer than 20 feet should be secured to the hillslope for stability. Full round downspouts are preferred over half-round downspouts.

Table 1. Maximum suggested spacing for ditch relief culverts<sup>1</sup> (ft)

Road grade (%)	Soil credibility				
	very high	high	moderate	slight	very low
2	600-800 <sup>2</sup>				
4	530	600-800 <sup>2</sup>			
6	355	585	600-800 <sup>2</sup>		
8	265	425	525	600-800 <sup>2</sup>	
10	160	340	420	555	
12	180	285	350	460	600-800 <sup>2</sup>
14	155	245	300	365	560
16	135	215	270	345	490
18	118	190	240	310	435

<sup>1</sup>Adapted from Transportation Handbook USDA Forest Service, R-6, 1966. Culvert spacing may be too great in locations where ditch runoff is accumulated and discharged onto steep hillslopes that are prone to gullying. Spacing is designed to control ditch erosion, not culvert outfall erosion, and are based on 25-year storm and precipitation rate of 1-2 in/hr for 15 minutes. If less, multiply by the intensity 0.50, 0.30, etc. If 2-3 in/hr, divide distance in table by 1.50, if 3-4 in/hr, divide by 1.75; and if 4-5 in/hr, divide by 2.00. The U.S. Forest Service also publishes abundant information on preventing and controlling gully erosion below culvert outfalls. From Hagans and Weaver (1994).

<sup>2</sup>Even with stable ditches, ditch relief culvert spacing greater than about 600 to 800 feet is generally not recommended due to the large volume of road surface and upslope runoff that would be discharged through the culvert and onto lower slopes during peak runoff periods. Culvert outlet erosion may occur with less than 800 feet of contributing ditch line, so observe local conditions to determine the upper limit of acceptable spacing in your area.

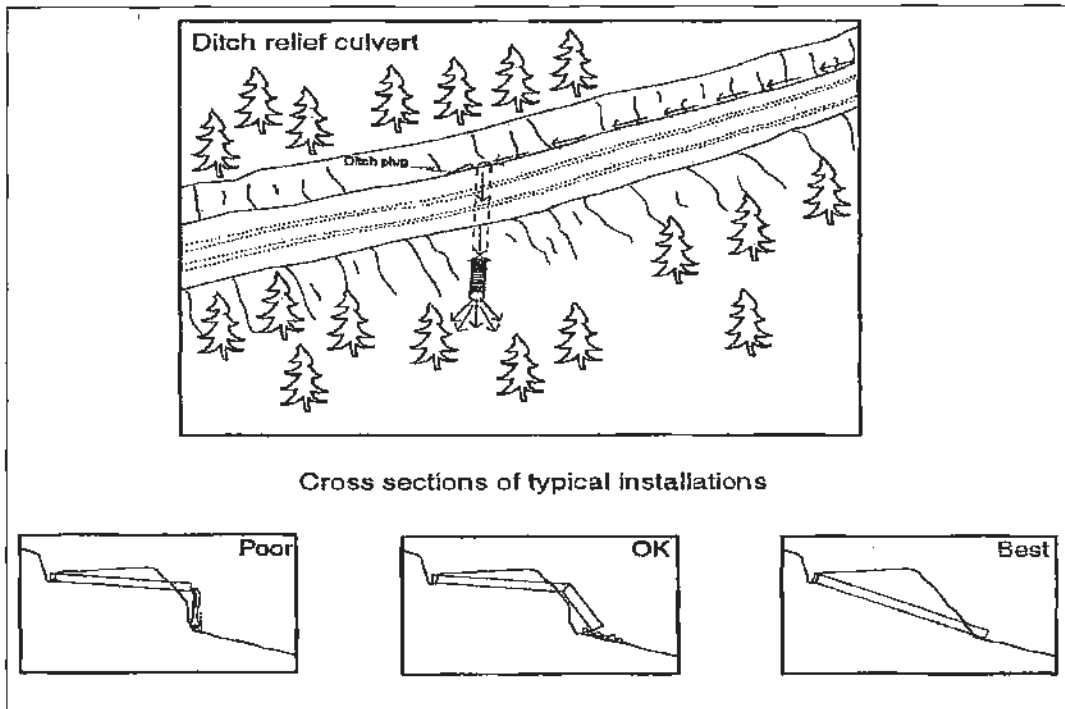

Figure 1. Typical ditch relief culvert installation. (CDFG, 2006)

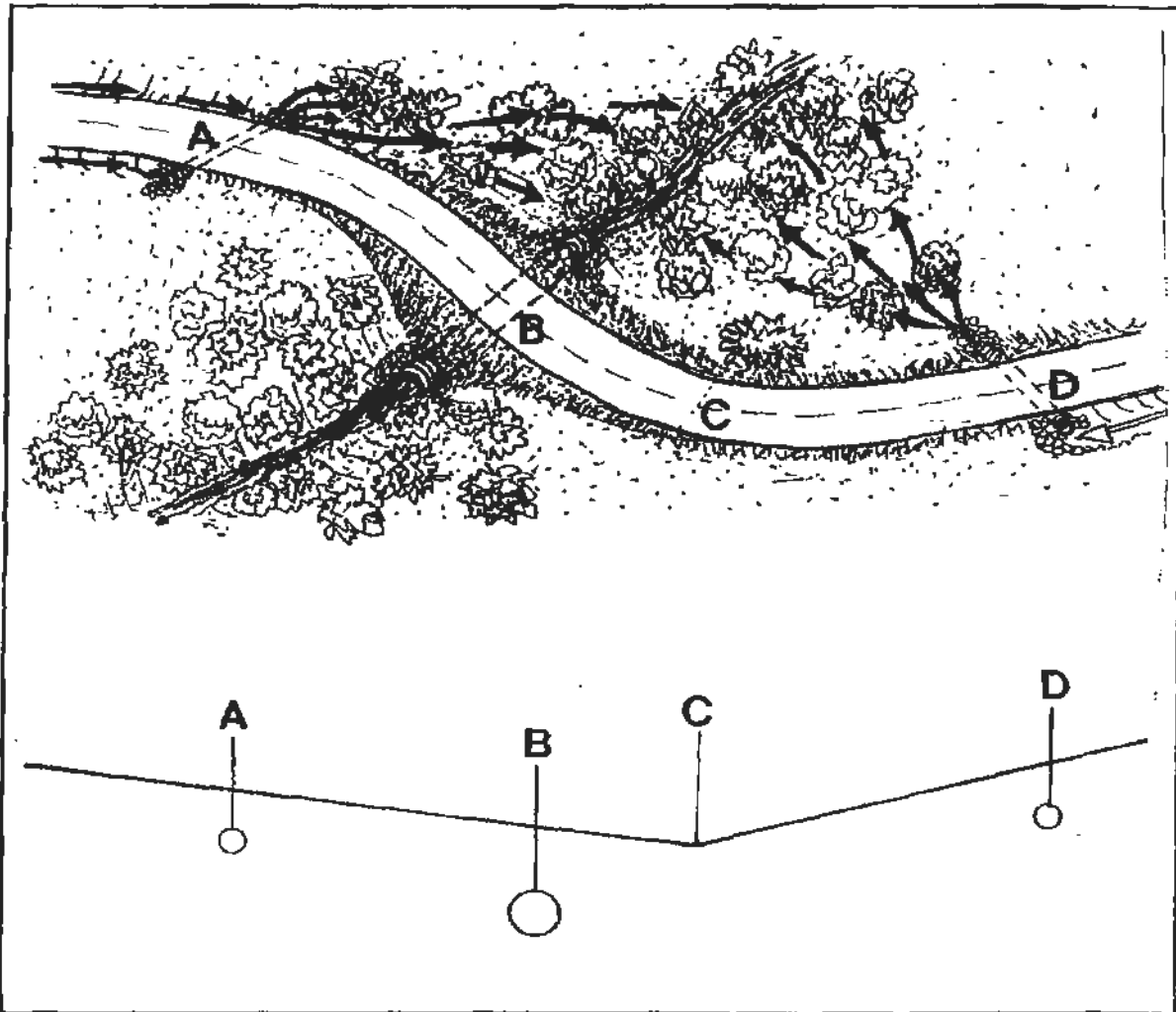

Figure 2. Where a road approaches a stream crossing (B), ditch flow should be culverted across the road (A,D) and discharged into a vegetated buffer that can filter the runoff before it reaches the watercourse. If the stream culvert plugs with debris or is topped by flood flows, flow will spillover the road at the change in grade at location "C" and back into the stream channel (modified from M.D.S.L. 1991). From Weaver and Hagans (1994).

**Source Material for Road BMP 2.10 Ditch Relief Culvert Installation**

2006. California Department of Fish and Game. Part X - Upslope Erosion Inventory and Sediment Control Guidance, California Salmonid Stream Habitat Restoration Manual.

2004. FishNet 4C. Guidelines for Protecting Aquatic Habitat and Salmon Fisheries for County Road Maintenance.

1994. Weaver W.E. and D.K. Hagans. Handbook for Forest and Ranch Roads. Mendocino County Resource Conservation District

## **RD-1.12 STREAM CROSSING INSTALLATION**

### **DESCRIPTION**

During road building, the construction of culverted stream crossings has the greatest potential of all activities to cause immediate sediment pollution. Culverts should be properly aligned, bedded, backfilled, and covered, or they will be subject to eventual failure. In all cases, disturbance to the stream banks and streambed should be minimized during stream crossing construction.

### **BEST MANAGEMENT PRACTICES**

- Culverts should be aligned with the natural stream channel. Correct alignment is critical for the culvert to function properly. Misalignment can result in bank erosion and debris plugging problems (Figure 69a).
- Stream crossing culverts should be placed at the base of the fill, and at the grade of the original streambed (Figure 1) (Figure 69d).
- Culvert should be inset slightly into the natural streambed so that water drops several inches as it enters the pipe. Culvert inlets set too low can plug with debris and those set too high can allow water to undercut the culvert (Figure 69b). Culverts placed midway up the outside of the fill are more likely to plug with sediment or organic debris, because their ability to pass materials is reduced, or to cause erosion of the fill below the culvert outlet (Figure 1).
- The culvert bed may be composed of either compacted rock-free soil, or gravel. If gravel is used for the bed, filter fabric will be needed to separate the gravel from the soil to minimize the potential for soil piping. Bedding beneath the culvert should provide for even distribution of the load over the length of the pipe.
- Inlet and outlet of the culvert should be armored. A metal, concrete, sandbag or rock head-wall can be constructed to prevent inlet erosion. A trash protector can be installed just upstream from the inlet where there is a hazard of floating limbs and wood chunks plugging the culvert inlet. This is especially important on logging roads where the upslope areas have recently been harvested or are slated for harvesting in the future.
- Stream crossings that are not at grade can be retrofitted with a downspout with rock placed at the outlet for armoring against hillslope erosion.

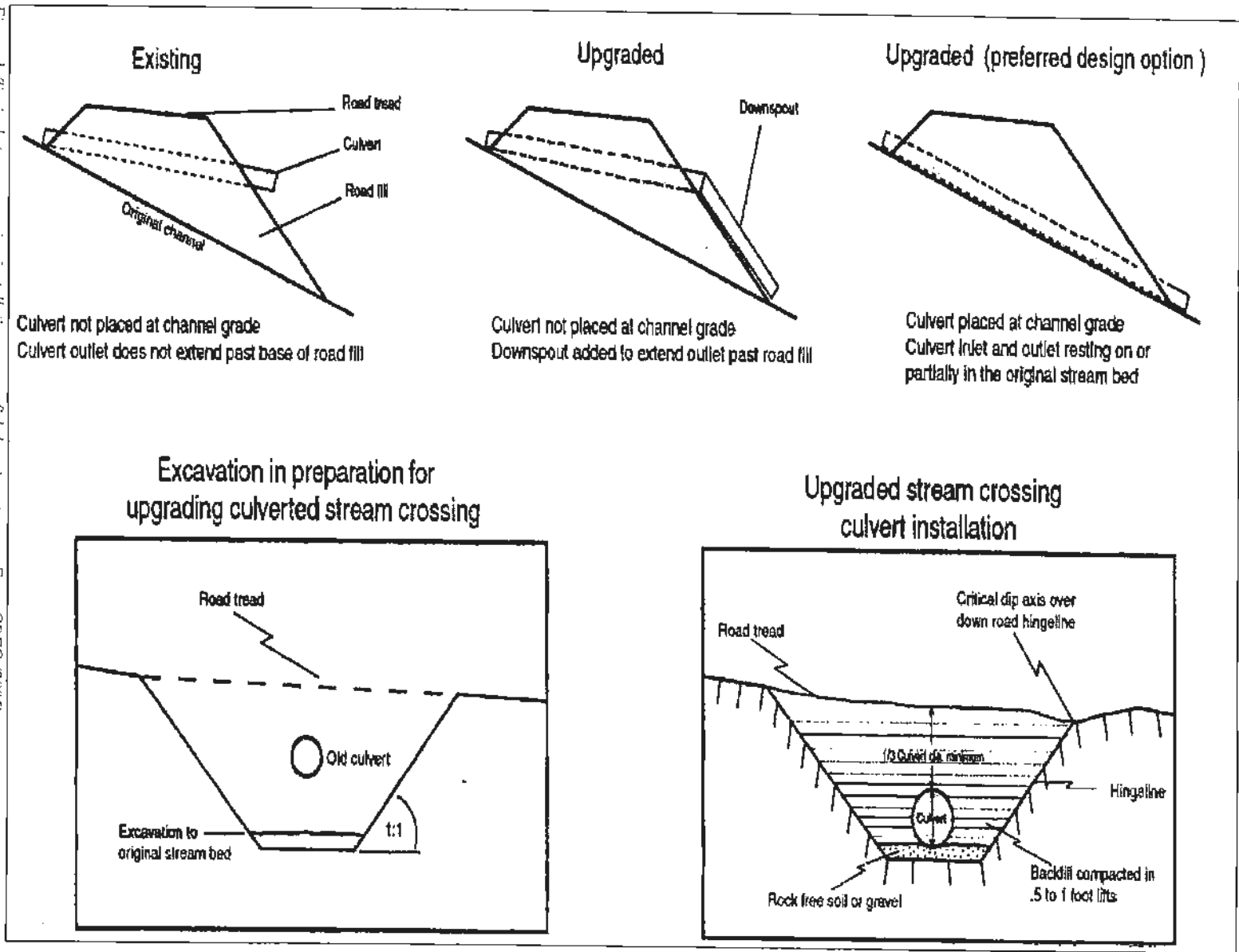

Figure 1. Typical stream crossing installation on non fish-bearing streams. From CDFG (2006).

Figure 69a, b. Proper culvert installation involves correct culvert orientation, setting the pipe slightly below the bed of the original stream, and backfilling and compacting the fill as it is placed over the culvert. Installing the inlet too low in the streambed (A) can lead to culvert plugging, yet if it set too high (B) flow can undercut the inlet (from M.D.S.L., 1991).

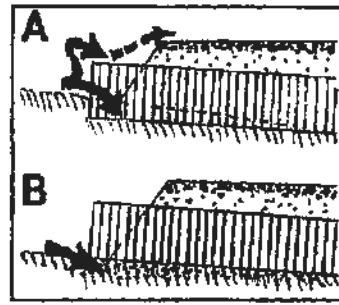

Figure 69c. If the culvert outlet is placed too high in the fill (C), flow at the outlet will erode the fill.

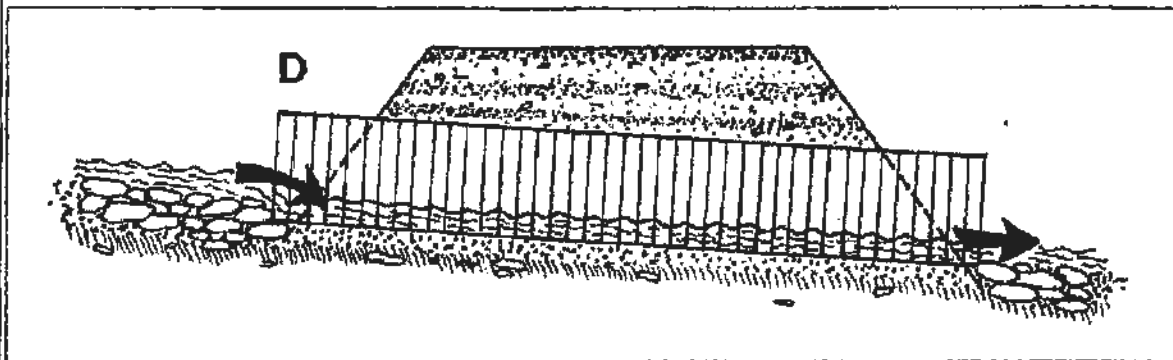
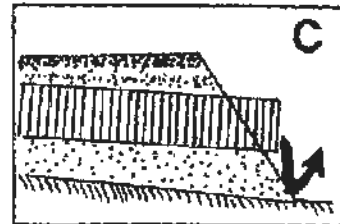

Figure 69d. Placed correctly (D), the culvert is set slightly below the original stream, grade and protected with armor at the inlet and outlet.

Figures 69a,b,c,d. Typical stream crossing installation. From Hagans and Weaver (1994)

**Source Material for Road BMP RD-2.8 Stream Crossing Installation**

2006. California Department of Fish and Game. Part X - Upslope Erosion Inventory and Sediment Control Guidance, California Salmonid Stream Habitat Restoration Manual.

1994. Weaver W.E. and D.K. Hagans. Handbook for Forest and Ranch Roads. Mendocino County Resource Conservation District

## **RD-1.13 DRAINAGE FOR UNPAVED ROAD SURFACES**

### **DESCRIPTION**

Roads should be designed and constructed to cause minimal disruption of natural drainage patterns. Provisions for two components of road drainage should be included in every road project: 1) road surface drainage (including drainage which *originates* from the cutbank, road surface, and fillslope); and 2) hillslope drainage (including drainage from large springs, gullies, and streams which *cross* the road alignment).

### **BEST MANAGEMENT PRACTICES**

- Maintain natural drainage patterns in watershed through installing drainage features to keep water within sub-basins.
- Crown or slope the road to avoid ponding or concentration of runoff. Outslope all roads where possible and safe (see Road BMP RD-1.3, 1.4 Outslope).
- Use rolling dips instead of ditch relief culverts (DRCs) when possible (Table 1) (Figure 1). Rolling dips require less maintenance and are less prone to failure than culverts (see Road BMP RD-1.8 Rolling Dips).
- Disconnect road drainage features from watershed hydrology. Shorten ditch lengths to stream crossings by installing a ditch relief culvert or rolling dip before the watercourse (see Road BMP RD-1.11 Ditch Relief Culvert Installation).
- In addition to installing DRCs on either approach to the stream crossings, it is also advisable to consider installing ditch drains before curves, above and below through-cut road sections, and before and after steep sections of the road.
- Ditches should neither be discharged directly into the inlet of a stream crossing culvert, nor should DRCs discharge into a watercourse without first directing flow through an adequate filter strip.
- Culverts should be designed and installed at intervals along the road that are close enough to prevent erosion of the ditch and at the culvert outfall. They should be installed at locations where collected water and sediment is not discharged directly into watercourses (Table 2).
- DRCs should not be used on erosive slopes without a downspout (see Construction BMP SS-11 Slope Drain).
- In areas of high erosion and/or storm runoff, *minimum* ditch relief culvert sizes should be 18 inches in diameter, and never less than 12 inches in other areas.
- A 10% grade to the culvert will usually be self-cleaning. The culvert grade should also be at least 2% greater than the ditch which feeds it. The culvert should be placed at a 30 degree skew to the ditch to improve inlet efficiency and prevent plugging and erosion at the inlet.



- Stream crossings culverts and DRCs should be installed at the gradient of the original ground slope, so it will emerge on the ground surface beyond the base of the fill. If not, either the fill below the culvert outlet should be armored with rock, or the culvert should be fitted with an anchored downspout to carry erosive flow past the base of the fill (Figure 2) (see Road BMP RD1.12 Stream Crossing Installation).
- Culverts should be covered by a minimum of 1 foot of compacted soil, or a depth of 30% of its diameter, whichever is greater.
- Inlet protection, such as rock armoring or drop structures, can be used to help minimize erosion.
- DRCs must be spaced frequently enough to carry ditch and road surface waters without creating erosive concentrated flows. See attached table for spacing guidelines.

Road grade %	Upslope approach (distance from up-road start of rolling dip to trough) (ft)	Reverse grade (distance from trough to crest) (ft)	Depth below average road grade at discharge end of trough (ft)	Depth below average road grade at upslope end of trough (ft)
<6	55	15-20	0.9	0.3
8	65	15-20	1.0	0.2
10	75	15-20	1.1	.01
12	85	20-25	1.2	.01
>12	100	20-25	1.3	.01

Table 1. Table of rolling dips dimensions. From CDFG (2006).

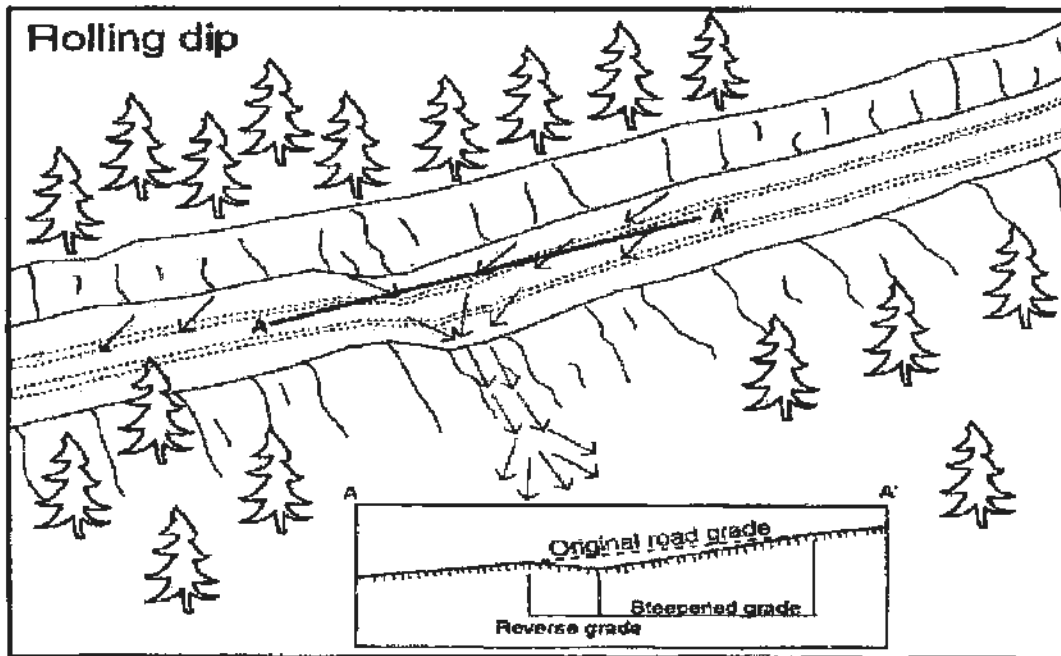

Figure 1. Use of rolling dips to reduce ditch erosion and surface runoff. Rolling dips must drain the road surface and be driveable for the expected traffic. From CDFG (2006).

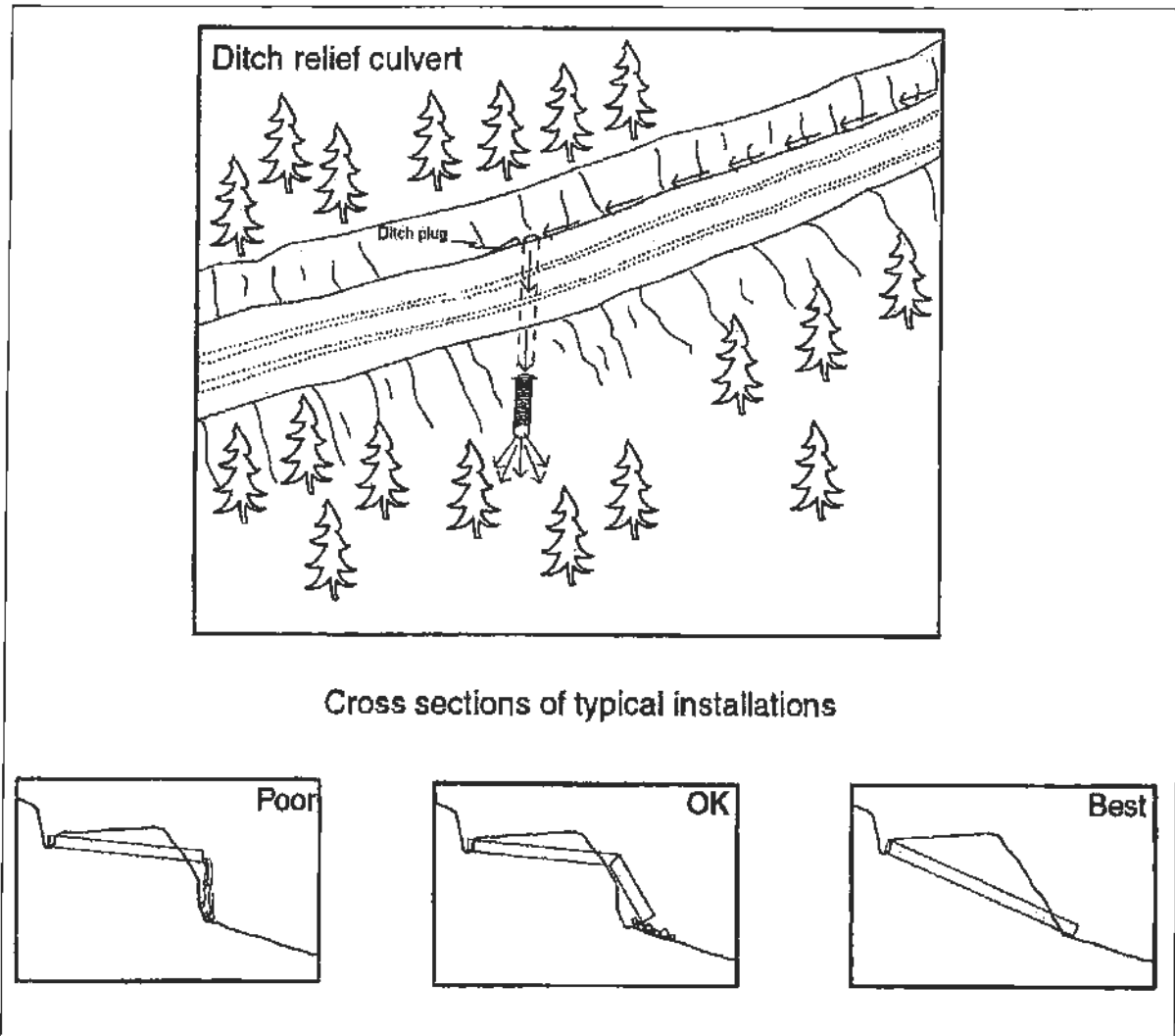

Figure 2. Typical ditch relief culvert installation. From CDFG (2002).

**Table 2. Maximum suggested spacing for ditch relief culverts<sup>1</sup> (ft)**

Road grade (%)	Soil credibility				
	very high	high	moderate	slight	very low
2	600-800 <sup>2</sup>				
4	530	600-800 <sup>2</sup>			
6	355	585	600-800 <sup>2</sup>		
8	285	425	525	600-800 <sup>2</sup>	
10	160	340	420	555	
12	180	285	350	460	600-800 <sup>2</sup>
14	155	245	300	365	560
16	135	215	270	345	490
18	118	190	240	310	435

<sup>1</sup>Adapted from Transportation Handbook USDA Forest Service, R-6, 1966. Culvert spacing may be too great in locations where ditch runoff is accumulated and discharged onto steep hillslopes that are prone to gullying. Spacing is designed to control ditch erosion, not culvert outfall erosion, and are based on 25-year storm and precipitation rate of 1-2 in/hr for 15 minutes. If less, multiply by the intensity 0.50, 0.30, etc. If 2-3 in/hr, divide distance in table by 1.50; if 3-4 in/hr, divide by 1.75; and if 4-5 in/hr, divide by 2.00. The U.S. Forest Service also publishes abundant information on preventing and controlling gully erosion below culvert outfalls. From Hagans and Weaver (1994).

<sup>2</sup>Even with stable ditches, ditch relief culvert spacing greater than about 600 to 800 feet is generally not recommended due to the large volume of road surface and cutslope runoff that would be discharged through the culvert and onto lower slopes during peak runoff periods. Culvert outlet erosion may occur with less than 800 feet of contributing ditch line, so observe local conditions to determine the upper limit of acceptable spacing in your area.

**Source Material for Road BMP RD-1.3 Road Drainage for Unpaved Road Surface**

2006. California Department of Fish and Game. Part X - Upslope Erosion Inventory and Sediment Control Guidance, California Salmonid Stream Habitat Restoration Manual.

1994. Weaver W.E. and D.K. Hagans. Handbook for Forest and Ranch Roads. Mendocino County Resource Conservation District

## **RD-1.14 ROAD SURFACE UPGRADE**

### **DESCRIPTION**

The road surface can be a big source of stream sediment. In some watersheds, it may be the primary source of accelerated (human-caused) erosion and sediment yield from the road system. Proper road construction and surfacing can significantly reduce this source of fine sediment. Permanent roads that are to be used for winter and wet weather hauling, including ranch roads and roads used for commercial hauling of forest products, need to be surfaced to improve trafficability and reduce erosion. Roads which receive heavy use should be inspected regularly to discover early signs of damage. Serious damage to road surfaces usually begins with the build up of thick (1-4 inch) accumulations of dry dust during the summer, or excess water (and mud) during the winter. Standing water is a sign of poor road drainage and ruts indicate that road strength is deteriorating.

### **BEST MANAGEMENT PRACTICES**

- Follow Road BMPS in RD-1.4 Road Surfacing.
- A stable and well drained subgrade is essential for a good road. The load bearing capacity of a road depends upon the subgrade's soil strength, drainage and compaction characteristics (Table 23). Native material is often suitable, and can be used for the road's subgrade. Weak or wet subgrades (soils unable to support a load by themselves) need to be strengthened by adding loose or crushed rock or gravel to provide ballast and distribute the stress placed on the soil.
- Wet, low strength soils may be stabilized by the use of synthetic fabrics (geotextiles) designed specifically for this application. The fabric is spread over the subgrade and then covered with a layer of rock. Water passes through the membrane, but the wet soil remains below and does not mix with the surface aggregate. As a result, the road dries faster and the fabric spreads the wheel loading pressures over a large surface area.
- The running surface of the road should be smooth and hard-wearing, and it should not be subject to blowing or washing away. The most commonly used surfacing materials are angular (crushed) rock. In the past, river-run gravel was frequently used where crushed rock was not readily available. However, rounded material is not as well suited as long lasting surfacing material and may be difficult to keep in-place.
- First, a "base course" of 2 to 3 inch diameter angular rock is usually dumped on the compacted native road surface using dump trucks, spread to a uniform depth using a grader or tractor and then compacted. The use of true compaction equipment (instead of tractors) will provide the best, longest lasting road surface. Geotextile engineering fabrics can be used beneath the base course material if soil conditions are wet. A finer "surface course" several inches in thickness is then spread over the compacted base course material to provide a dense, smooth running surface. The resulting layers of angular, interlocking rock will provide a low impact road surface that can be used during much of the winter (Table 24) (Figure 1).
- For all-weather use, angular rock should be placed to a total depth of 6-10 inches, or more, which will then compact to a finished depth of 4 to 6 inches under normal use. Table 24 lists the volume of aggregate needed to surface one mile of road, ranging from 10-20 feet wide, to a depth of 1-6 inches.

**Table 23. Soil characteristics for road subgrade materials<sup>1</sup>**

Material type	Strength, compaction and foundation suitability	Drainage	Reaction to frost	Common symbols of soil types <sup>2</sup>
Clean gravels and clean sand <sup>3</sup>	Good to excellent	Excellent	None to slight	GW, GP, SW, SP
Gravels and sands with non-plastic <sup>4</sup> fines	Good to excellent	Fair to poor	Slight to high	GMd, SMd
Gravels and sands with plastic <sup>4</sup> fines	Fair to good	Poor to impervious	Slight to high	GMu, GC, SMu, SC
Non-plastic and slightly plastic <sup>4</sup> silts and clays	Poor to fair	Fair to impervious (mostly poor)	Medium to high	ML, CL, OL
Medium and highly plastic <sup>4</sup> silts and clays	Very poor to poor	Fair to impervious (mostly poor)	Medium to very high	MH, CH
Peat and other highly organic soils	Very unstable, poor compaction	Fair to poor	Slight	Pt

<sup>1</sup> W.D.N.R. (1982)

<sup>2</sup> Unified Soil Classification System (USCS) symbol

<sup>3</sup> "Clean" means: less than about 12% of the material is smaller than 1/64" (the smallest particle visible to the naked eye)

<sup>4</sup> Plasticity can be tested by simple field methods, including lightly wetting a hand sample, rolling the fines into a ball and then into a thread before it crumbles.

Non-plastic: a thread cannot be formed, regardless of the moisture content. Low plasticity: after 2-3 times, the molded ball will crumble.

Medium plasticity: after 3-5 times, the ball will easily crumble with moderate force (pressed between thumb and forefinger).

High plasticity: ball will not crumble, even with moderate force, after five times.

Table 23. From Weaver and Hagans (1994).

Figure 1. Cross section diagram showing typical base-course and surface-course application for forest and ranch roads (USDA\_SCS, 1983). From Weaver and Hagans (1994).

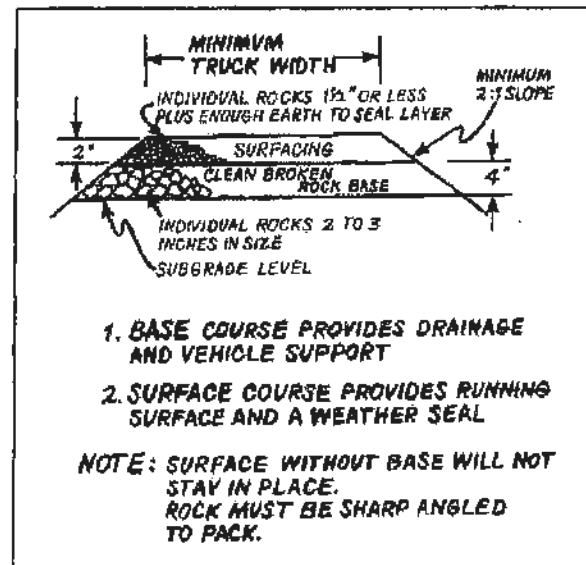

Table 24. Aggregate (yds<sup>3</sup>) required to one mile of road<sup>1</sup>

Road width (ft)	Depth of uncompacted rock (inches)					
	2"	4"	6"	8"	10"	12"
10'	326	652	978	1,304	1,630	1,956
12'	391	782	1,174	1,564	1,956	2,348
14'	456	913	1,369	1,826	2,282	2,738
16'	521	1,043	1,565	2,086	2,608	3,130
18'	587	1,174	1,760	2,348	2,934	3,520
20'	652	1,304	1,956	2,608	3,260	3,912

<sup>1</sup> USDA (1973). Uncompacted, 16.3 yds<sup>3</sup> equals 1 inch deep by 1 foot wide by 1 mile long. When aggregate is compacted, increase volumes required by 15-30%, depending on type and gradation of material.

From Weaver and Hagans (1994).

**Source Material for Road BMP RD-6.2 Road Surface Upgrade**

1994, Weaver W.E. and D.K. Hagans. Handbook for Forest and Ranch Roads. Mendocino County Resource Conservation District

## RD-1.15 ROUTING AND LOCATION

### DESCRIPTION

Roads should be plotted and located by a person with some knowledge of the area to be served by the road and of the terrain where the road is to be built. An engineer or geologist should be consulted in routing forest system roads to identify unstable terrain and to protect aquatic resources.

### LIMITATIONS

Road system layout is influenced by many factors, including topography, property lines, obstacles (rock outcrops, unstable areas, etc), and proposed land use activities. Controls on the location of a road include both natural features and man-made elements (Table 1).

Control	Comment
Legal	Boundary lines limit the location of a road. Talk with adjacent landowners and work out written right-of-way agreements to share roads and reduce road construction.
Specific Location	The beginning and ending points of a road are often fixed. These represent major controls.
Safety	Each class of road and level of use have specific safety requirements. Common sense should be applied in setting speed, grades, curve radius, sight distance, and turnouts.
Pollution Control	Roads should avoid problem areas. Allow ample room to trap sediment in a buffer before it reaches a stream. Do not allow any direct discharge points where road runoff flows directly into the stream. Avoid flood plains, landslides, erodible soils, etc., as well as slopes over 40% wherever possible.
Design Elements	Physical limits for curve radius, road grade, pitch grade, stopping distance and separation from streams are set by you. Design to reduce maintenance costs and pollution potential.
Migrating Fish	Observe and maintain substantial buffers. Know what species use your streams, their habitat requirements, the susceptible periods of their life cycle, and their environmental tolerance limits. Permits may be needed from the Department of Fish and Game.
Approach Roads Permits	Issued by California Department of Transportation of the County for roads connecting to public highways. Location for intersections may be restricted.

*From Hagans and Weaver (1994). <sup>1</sup> Adapted from USD A-SCS (1981).*

### BEST MANAGEMENT PRACTICES

- Identify and map the following conditions on the ground during the road layout process (Table 10):
  - favorable topography (especially benches and low gradient areas for landings turnouts and spoil disposal)
  - control points (the beginning and ending points, saddles and other sites)
  - obstacles (especially unstable or erodible soils, large rock outcrops and wet areas)
  - stream channels (including their degree of incision)
  - inner gorge locations
  - areas of steep slopes
  - any other obvious hazards or controls

Control		Comment
Saddles		Major control for road location
Ridges		Major control and often a satisfactory road site.
Stream crossings		Major control. Seek locations with gentle side slopes and locations wide enough to accommodate the road. Good sites for bridges or culverts are needed. Evaluate for migratory fish where needed. Will need Fish and Game 1603 permit.
Benches		Often a good location for road junctions, switchbacks, landings, turnouts, etc.
Cliffs or rock outcrops		Cross above or below at a safe location. Rock which can be ripped is less costly to remove than hard rock needing blasting.
Slides		Major control. Avoid or cross at the safest point. Ask for professional geotechnical assistance.
Wetlands (bogs, swamps, wet meadows)		Major control. Avoid where possible or cross quickly at best point. May need Fish and Game clearance.
Valley floor	wide	Low gradient, desirable road location if above the flood line. If crossing, cross and get out of floodplain quickly. Little excavation required. Fish and Game permit may be required.
	narrow	Poor location because of flooding, erosion and pollution potential and high costs to cross the stream if it meanders. Keep road above floodplain. Fish and Game 1603 permit may be required.
Slopes	>40%, but <60%	Avoid sidestepping and sliver fills (thin blankets of fill placed on steep slopes) in which large bare areas are exposed to erosion. This loose sediment may be difficult to control because of long buffers needed.
	≥60%	Construction in unstable areas should be avoided. Full bench road construction and embankment material may be needed where slopes remain steep alongside stream channels. Proceed only with extreme caution. Avoid road construction on these steep slopes if possible.
	ridge crest	Good alignment and little excavation. Good drainage. Few culverts required. Adverse grade encountered on uneven ridges. Spur roads will have an adverse grade.
Aspect		Maintenance requirements in moist climates can be minimized by planting woods on south-facing slopes to promote drying and snow melt. In dry climates, the north-facing slopes have more vegetation and may have less erosion. Extremely wet or dry climate negates this effect.
Rock slope (dip)		Place roads on the hillside where rocks dip (slant) into the hillside, not parallel to or out of the hillside. Consult a geologist for other problems and advice.
Soils		Where possible, avoid road building on naturally erodible soils. Check soils maps for potential problems and ask extension agents or the SCS for advice. Erosion soils require special care; ask for assistance.

From Weaver and Hagans (1994). <sup>1</sup> Adapted from USDA-SCS (1981)

- Identify and evaluate nearby rock outcrops for potential rock aggregate for road surfacing materials.
- Identify broad ridge crests and benches as possible locations for landings, road turnouts and spoil disposal sites (Figure 1).
- Locate switchback with little or no grade so that trucks and equipment can pass safely and so they won't tear up the road surface while turning the corner and continuing up the road.



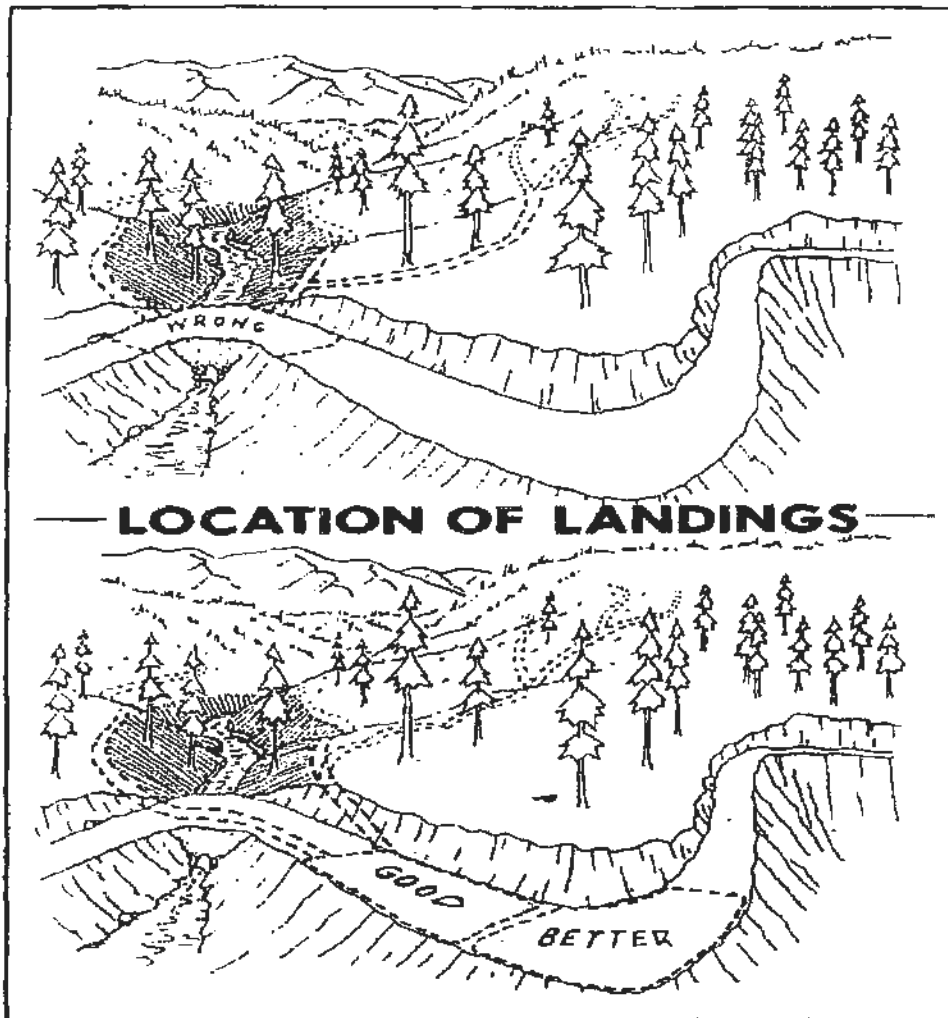

Figure 1. Log landings on forest road systems should be kept to the absolute minimum size necessary to accommodate yarding, loading and hauling equipment and the minimum number needed to remove timber resources. Landings constructed on gentle ground and broad ridge crests far removed from stream channels are least likely to cause water quality problems, whereas landings built on steep slopes and near watercourses can result in severe impacts. From Weaver and Hagans (1994). Adapted from (USFS, 1963).

For more information, see Handbook for Forest and Ranch Roads. Weaver and Hagans (1994) and consult a trained engineer or geologist before construction. A trained wildlife biologist may be required to investigate for endangered species or species of special concern. An archaeologist may occasionally be needed to identify cultural sites that have to be avoided or mitigated before construction can begin.

**Source Material for Road BMP RD-1.2 Routing and Location**

1994. Weaver W.E. and D.K. Hagans. Handbook for Forest and Ranch Roads. Mendocino County Resource Conservation District

## **RD-1.16 UNDERSTANDING ROAD REMOVAL**

### **DESCRIPTION**

Approaches to removing roads may be divided into six categories: closure, abandonment, reclassification as trail, decommissioning, conversion to trail, and obliteration (Figure 1).

### **REMOVAL OPTIONS**

#### **Closure**

Some agencies close roads with gates, berms, or deep ditches (tank traps) as an approach to road removal (see Road BMP RD-7.3 Road Closure). On-the-ground surveys indicate that conventional closure devices are ineffective at stopping road use by people intent on accessing restricted areas. With an effective device that prohibits motorized access, however, closure may reduce a road's terrestrial impacts by providing wildlife security. Even so, closure is an ineffective approach to removing a road, because the road continues to disrupt natural drainage patterns, cause soil erosion, and potentially initiate mass failures; in short, a closed road continues to impact aquatic ecosystems.

#### **Abandonment**

When a road is "abandoned," it is no longer maintained and may or may not be driveable based on physical conditions or the presence of vegetation. The Forest Service considers road abandonment a "no-action treatment" (Moll 1996). Like a closed road with an effective closure device, abandoned roads that no longer receive motorized use may reduce a road's terrestrial impacts by providing wildlife security. Simply discontinuing maintenance and abandoning a road, however, rarely prevents continuing and potential hydrologic problems. The presence of vegetation may provide the false idea that the road is recovering and is no longer problematic. Culverts can become plugged, and roads may continue to function as surface flow paths for water. Road fills may remain unstable and susceptible to failure. Because an abandoned road continues to impact aquatic ecosystems, abandonment is an ineffective approach to removing a road.

#### **Reclassification as Trail**

Reclassifying a road as a trail without restoring drainage patterns and stabilizing fill materials is not an effective approach to removing a road, especially if motorized use continues. Even if wildlife security is improved by stopping motorized use, simply reclassifying a road as a trail does not address a road's aquatic impacts; this type of approach is basically the same as abandonment. If a road is changed to a trail, it must be actively converted (see "Conversion to trail" below) by first stabilizing fill materials and dispersing concentrated water.

#### **Decommissioning**

Decommissioning is carried out to minimize short-term sediment production, while "storing" a road for future use. Major treatments include removing stream crossings and stabilizing sidecast fill material. Site-specific drainage treatments such as constructing cross road drains, removing inboard ditches, and/or outsliping also help disperse concentrated water. Road surfaces may be mechanically scarified to facilitate revegetation. The goal of decommissioning is to leave much of the road prism intact so the road can be reconstructed in the future with only minimal effort. Decommissioning preserves most of the original construction investment, while reducing road-caused erosion and avoiding maintenance and/or repair costs. Other common terms used to indicate road removal with plans for future reconstruction

include storm-proofing, flood-proofing, erosion-proofing, putting-to-bed, deactivation, reclamation, hydrologic closure, hydrologic obliteration, and storage for future use. Planning for reconstruction and leaving much of the road prism intact may result in treating a road too lightly during removal. Future plans may change; post-decommissioning is too late to further treat the road for the long-term. Even if decommissioning stops road-related erosion in the shortterm, it is not the same as obliterating a road because the road is expected to be reconstructed. Even if roads may be reconstructed in the future, they should be removed as if reconstruction will not occur.

**Conversion to Trail**

Converting a road to a modest walking trail can be an effective approach to removing a road if all fill materials are stabilized before the trail is constructed. Some road-to-trail conversions are implemented by only partially recontouring a road, which may not stabilize all fill materials. Conversion is ineffective when ORVs are allowed because impacts associated with motorized use continue. Though trails are less intrusive and damaging than roads, they can cause similar impacts, such as stream sedimentation and facilitation of non-native species invasions.

**Obliteration**

Obliteration involves removing a road with no plans for future reconstruction. To be most effective, obliteration restores the original landform to the greatest extent possible. Stream crossings are removed and slopes are recontoured. Road surfaces and fill sites are ripped to improve subsurface water flow. Coarse woody debris placed on the recontoured road surface provides erosion protection, long-term nutrient sources, and wildlife habitat. Revegetation is also actively carried out with native species collected near the site. Fully obliterating roads speeds the restoration and recovery of hydrologic function, as well as ecological and evolutionary processes. If implemented appropriately, obliteration is the most effective approach to road removal since it addresses both terrestrial and aquatic impacts caused by roads.

Road impact considerations	How different approaches to removing roads address road impact considerations					
	Close	Abandon	Reclassify as trail	Decommission	Convert to trail	Obliterate
Is wildlife security improved?	Yes* (short-term)	Yes (long-term)	Depends on extent of trail use	Yes* (short-term)	Depends on extent of trail use	Yes* (long-term)
Are fill stability problems fixed?	No	No	No	Yes* (short-term)	Yes*	Yes*
Is surface erosion controlled?	No	No	No	Yes* (short-term)	No* (much reduced)	Yes*
Will the road be reopened or reconstructed?	Yes	No	No	Yes	No	No
Is motorized use accommodated? **	Yes	Yes (unless overgrown)	Yes	No*	Yes	No*
Will continued maintenance and repair funding be necessary?	Yes	No	Yes	No* (until reconstructed)	Yes	No*
* if implemented effectively ** decommissioned and obliterated roads may continue to accommodate winter use by snowmobiles						

Figure 1. From Bagley (1998).

## **REMOVAL TREATMENT OPTIONS**

Specific road removal treatments include removing stream crossings, constructing cross road drains, ripping, recontouring, and outsloping. Each treatment is summarized below.

### **Stream Crossing**

Stream crossing removal is a fundamental treatment for removing roads. When done correctly, stream crossings are removed by excavating all fill materials and restoring the original channel and valley shape. Simply removing culverts is not enough, because any remaining road fill will erode into the channel. Materials excavated from stream crossings can be used to recontour road segments to their natural slope, essentially returning fill to the location from which it was cut. Endhauling is necessary when the amount of fill removed is greater than that needed for recontouring. Any road removal project that does not remove stream crossings (or does not remove all fill materials) is not effective and may cause more ecological damage by causing additional sedimentation.

### **Cross Road Drains**

Cross road drains are deep ditches excavated across road surfaces (similar to waterbars, but more substantial) to facilitate drainage on closed roads. They are too deep and steep to be cleared by motor vehicles. Unless spaced frequently enough to disperse concentrated water, cross road drains may cause erosion downslope. They must be constructed more frequently on roads with steep grades, but are not necessary if roads are fully recontoured or outsloped steeply.

### **Ripping**

Ripping involves decompacting road surfaces and fill sites to a depth of two to three feet. The goal is to enhance subsurface water flow by reducing soil density and increasing porosity, infiltration, and percolation. Ripping relatively impermeable fill sites reduces the chance of fill saturation and failure. Some soil settling occurs since organic matter is limited in sterile road soils. Therefore, adding organic matter to the ripped soil can greatly accelerate the recovery of hydrologic function, including both infiltration and percolation (Luce 1997). Ripping also increases revegetation success.

### **Recontouring**

Recontouring involves placing all fill materials back into locations where fill was removed during road construction. Recontouring restores the original slope as much as possible, dispersing concentrated water and greatly enhancing slope stability. Full recontouring is sometimes impossible, especially on very steep slopes, since the sidecast material may have slid downhill out of reach. In some cases, outslops will be so high and road cuts so narrow, that replaced fill material will not blend with the original undisturbed slope. Even so, slope recontouring to the extent possible generally results in the most stable landform shape, restores natural surface runoff patterns, and deters motorized access.

### **Outsloping**

Outsloping involves filling inboard ditches with sidecast fill material and sloping the road surface to disperse water to the downhill side of the road. Some sidecast fill materials remain, but saturation and potential failure is reduced because water cannot concentrate in inboard ditches or on the road surface. The remaining fill slope materials may still cause stability problems, especially on steep slopes.

**Source Material for Road BMP RD-7.2 Understanding Road Removal**

1983. Bagley, Scott. The Road-Ripper's Guide to Wildland Road Removal. Wildlands Center for Preventing Roads

1994. Weaver W.E. and D.K. Hagans. Handbook for Forest and Ranch Roads. Mendocino County Resource Conservation District

**RD-1.17 ROAD CLOSURE**

**DESCRIPTION**

Road closure is an effective tool in managing road systems to protect private property, road systems, water quality, and sensitive landscapes. Choosing the access control treatment depends on the type of vehicle access to be discouraged and the length of the closure (Table 1). For example, closure treatments can be designed to discourage motorized traffic, but allow mountain biking or walking access. Closure treatments can also be designed to permanently close a road or allow seasonal treatments. The closure treatment chosen should reflect both the short term and long term use of the road system.

**BEST MANAGEMENT PRACTICES**

Closure Type	Description	Purpose Application
Blockage with On-Site Materials	Rock, logs, stumps, slash piles, posts, water bars, tank traps, decomposition	Discourage use, economical, dependent on-site and available material
Vegetative Planting, Seeding	Trees, shrubs, cactus, and grass seeding, recycled paper mulch, chip and spread slash	Discourage use, camouflage road, speed revegetation and healing of site, provide browse and forage
Imported Material	Fences, gates, posts, guardrails, concrete barriers	Discourage use, lack of on-site material or inappropriate site for use of on-site materials
Pole Fences Wood Barriers	Onsite or imported poles, reinforce with metal strips to deter chain-sawing	Discourage use, can be dismantled for emergency access, aesthetically pleasing
Closure Devices	Materials used include metal telescoping tubing, pipe, and well casing. Available in single lane to double lane widths	Discourage use, allow quick easy access, single or multiple locks, signing
Obliteration	Re-contour road junction or entire road. Combine with other closure treatments. Removal of drainage structures, bridges, and associated embankments	Eliminate travelway, return corridor to resource production, reduce modifications to hydrology and aesthetics, camouflage road

Table 1. Access Control Treatments. Adapted from US Forest Service 1996.

**Source Material for Road BMP RD-7.3 Road Closure**

1996. US Forest Service. A Guide for Road Closure and Obliteration in the Forest Service. Technology and Development Program. Publication: 9677 1205.

# EC-1.1 JUTE MAT BLANKET

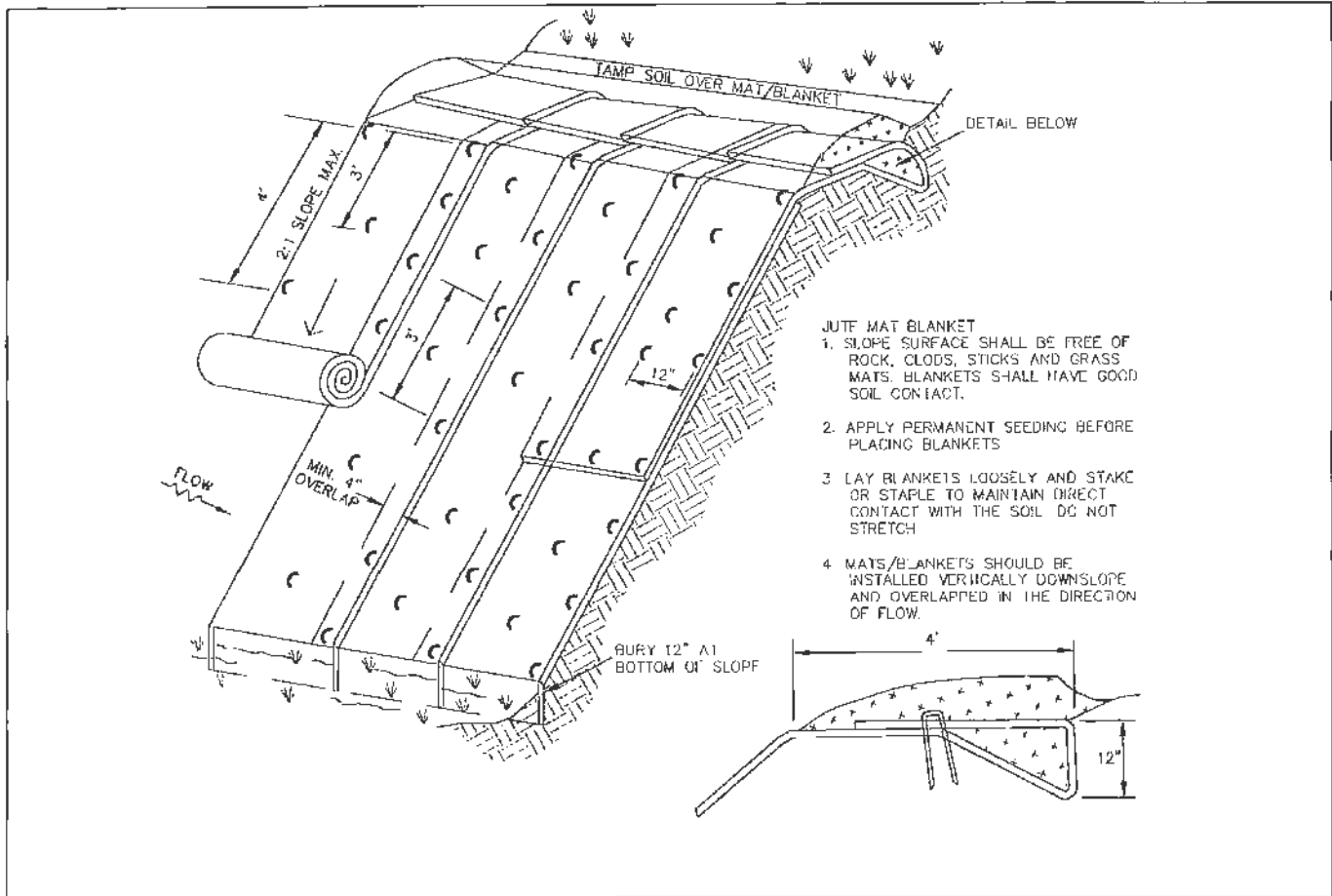

## JUTE MAT BLANKET

1. SLOPE SURFACE SHALL BE FREE OF ROCK, CLODS, STICKS AND GRASS. MATS/BLANKETS SHALL HAVE GOOD SOIL CONTACT.
2. APPLY PERMANENT SEEDING BEFORE PLACING BLANKETS
3. LAY BLANKETS LOOSELY AND STAKE OR STAPLE TO MAINTAIN DIRECT CONTACT WITH THE SOIL DO NOT STRETCH
4. MATS/BLANKETS SHOULD BE INSTALLED VERTICALLY DOWNSLOPE AND OVERLAPPED IN THE DIRECTION OF FLOW.

WATER RESOURCE PROTECTION PLAN (WRPP) – NorthPoint Consulting

## **EC-1.2 CULVERT OUTLET ENERGY DISSIPATER**

### **DESCRIPTION**

An energy dissipater is a structure designed to control erosion at the outlet of a culvert or conduit by reducing the velocity of flow and dissipating the energy (see BMP SS-10 Outlet Protection/Velocity Dissipation Devices).

### **LIMITATIONS**

- Do not use this BMP below the mean high water line of any water body before obtaining appropriate permits. Due to issues relative to Corps 404 jurisdiction sometimes energy dissipaters are not placed below the ordinary high water mark which results in increased erosion.
- Consider other energy dissipaters such as concrete impact basins, paved outlet structures, or a half culvert where site conditions warrant.
- Rock/riprap dissipaters may require containment in mattresses to maintain their effectiveness.

### **BEST MANAGEMENT PRACTICES**

- Size rock to handle high velocity storm events.
- Key rock into sides of fillslope to prevent undercutting (Figure 1).
- Best results are obtained when sound, durable, angular rock is used (Figure 2).
- Inspect after each significant rain for erosion and/or disruption of the rock, and repair immediately.

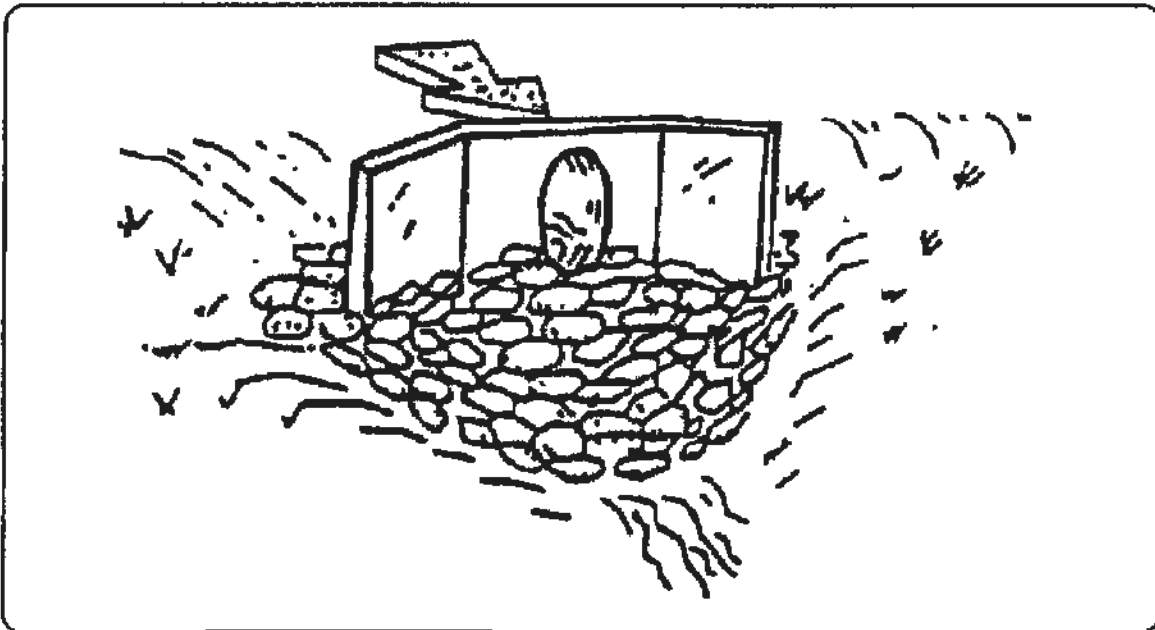

*Figure 1. Flared outlet with rock energy dissipater. From Weber County, UT.*



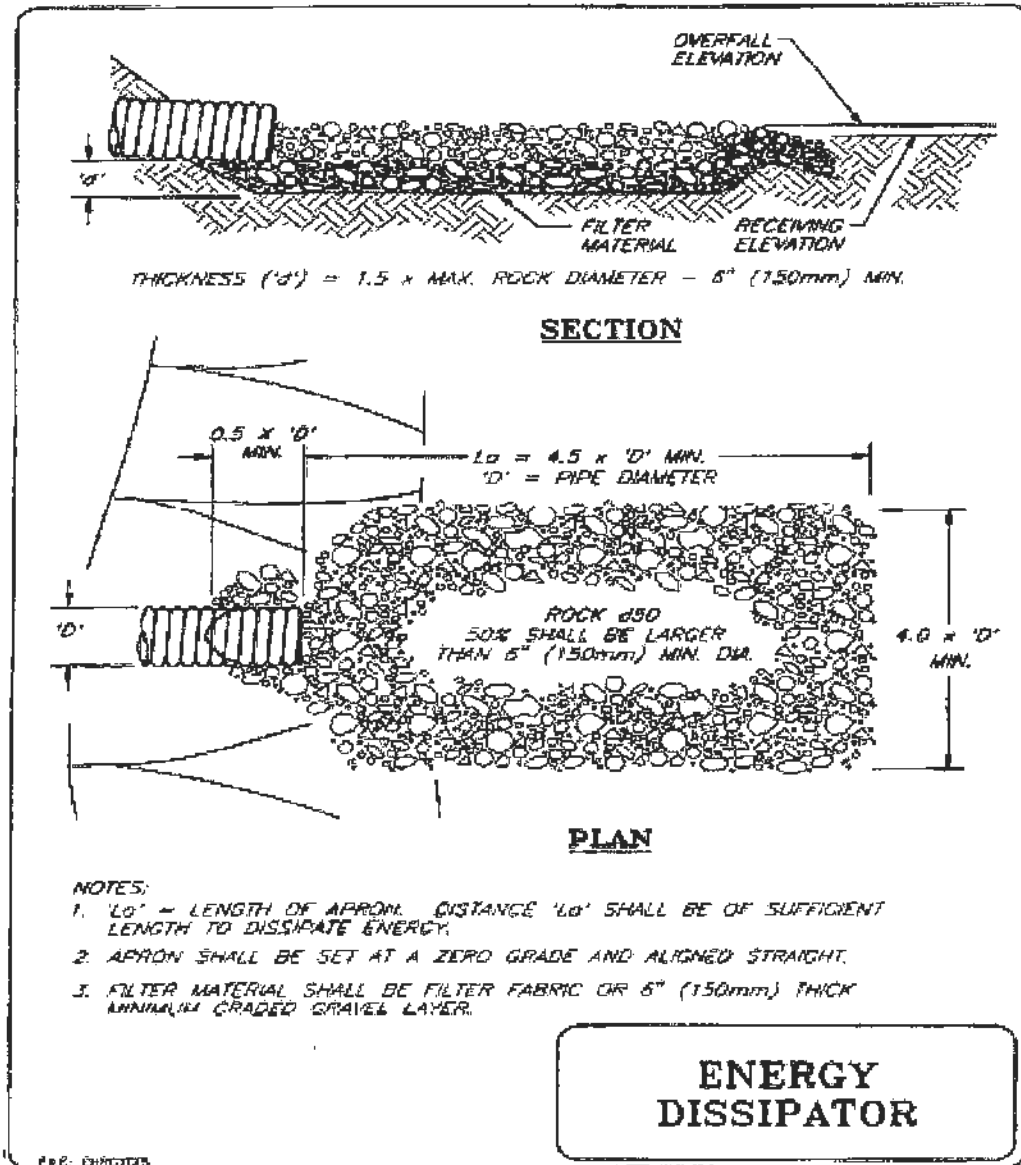

Figure 2 Rock energy dissipator. From 2004 Fishnet 4C. Adapted from 1994 McCullah.

**Source Material for Road BMP RD-2.12 Culvert Outlet Energy Dissipater**

2004. FishNet 4C. Guidelines for Protecting Aquatic Habitat and Salmon Fisheries for County Road Maintenance.

N/A. Weber County, Engineering Department. Ogden, Utah.

## **EC-1.3 OUTLET PROTECTION**

### **DESCRIPTION**

A rock outlet protection is a physical device composed of rock, riprap, grouted riprap, or concrete rubble which is placed at the outlet of a pipe to prevent scour of the soil caused by high pipe flow velocities, and to absorb flow energy to produce nonerosive velocities (see Construction BMP SS-10 Outlet Protection/ Velocity Dissipation Devices).

### **APPLICATIONS:**

- Wherever discharge velocities and energies at the outlets of culverts, conduits, or channels are sufficient to erode the next downstream reach.
- Rock outlet protection is best suited for temporary use during construction because it is usually less expensive and easier to install than concrete aprons or an energy dissipater (Figure 1) (see Erosion Control BMP EC-1.3 Energy Dissipater).
- A sediment trap below the pipe outlet is recommended if runoff is sediment laden (Figure 2).
- Permanent rock riprap protection should be designed and sized by the engineer as part of the culvert, conduit or channel design (Figure 2).
- Grouted riprap should be avoided in areas of freeze and thaw because the grout will break up.

### **LIMITATIONS**

- Large storms often wash away the rock outlet protection and leave the area susceptible to erosion.
- Sediment captured by the rock outlet protection may be difficult to remove without removing the rock.
- Outlet protection may negatively impact the channel habitat in streams.

### **BEST MANAGEMENT PRACTICES**

- Size rock to handle high velocity storm events (Figure 3).
- Key rock into sides of fillslope to prevent undercutting.
- Best results are obtained when sound, durable, angular rock is used.
- Inspect after each significant rain for erosion and/or disruption of the rock, and repair immediately.

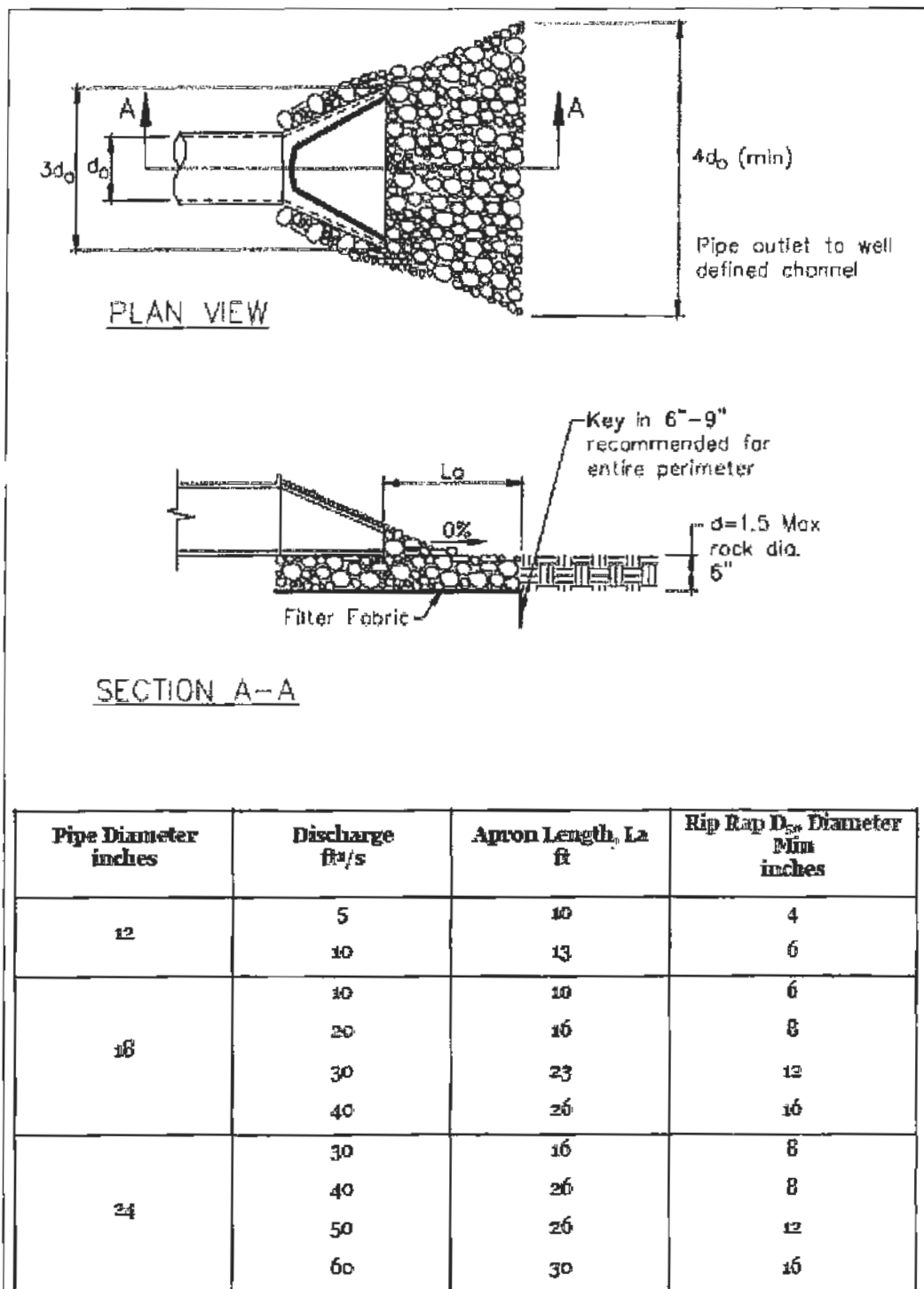

Figure 1. Flared outlet with energy dissipater. From Caltrans (2003). (Adapted from USDA-SCS).

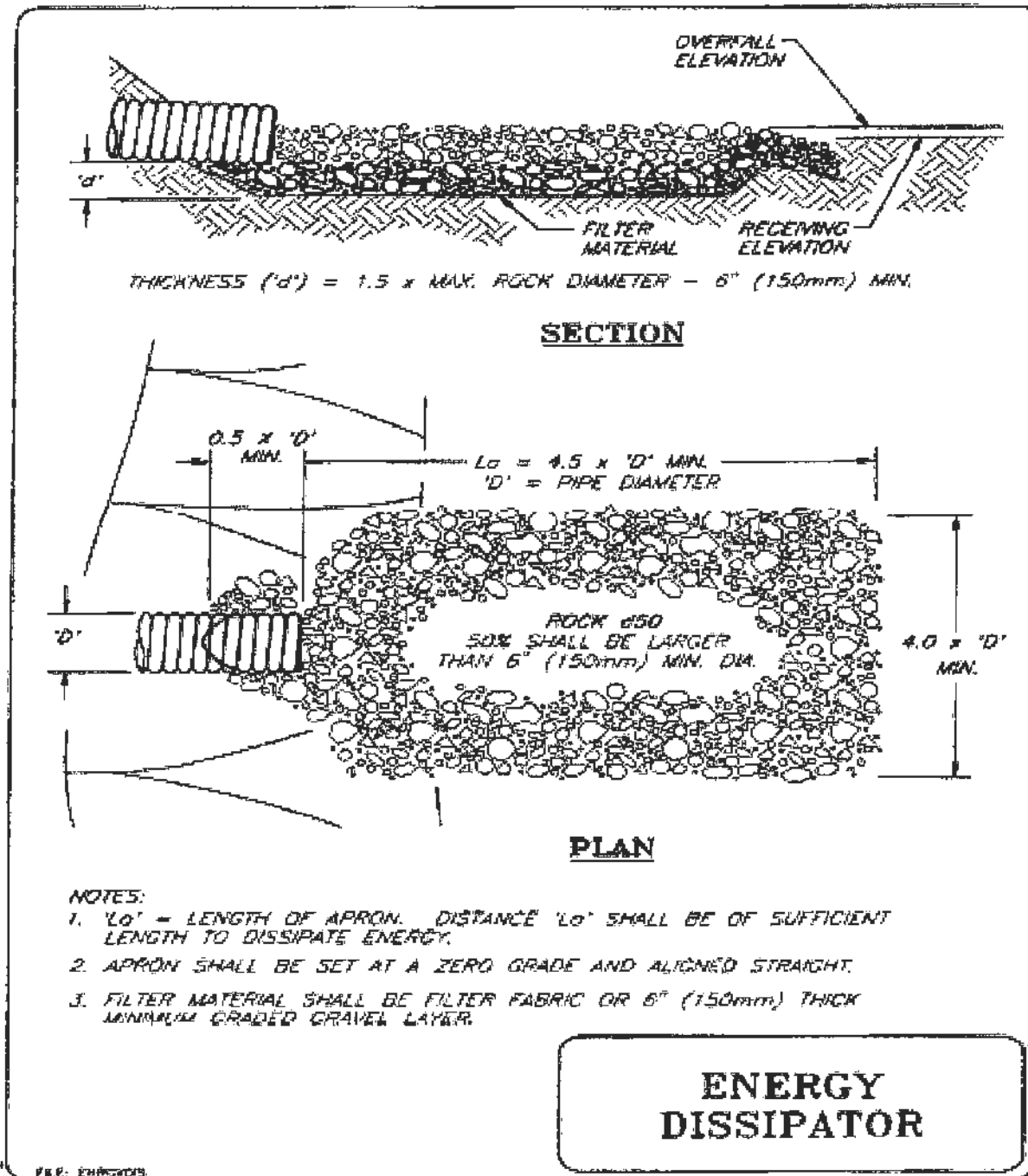

Figure 2. Rock energy dissipator. From 2004 Fishnet 4C. Adapted from 1994 McCullah.



*Figure 3. Rock armoring on shotgun culvert outlet. Photo Courtesy of California Department of Transportation (Caltrans).*

**Source Material for Road BMP RD-2.11 Outlet Protection**

2003. California Department of Transportation (CALTRANS). Storm Water Quality Handbooks – Construction Site Best Management Practices (BMPs) Manual.

2004. FishNet 4C. Guidelines for Protecting Aquatic Habitat and Salmon Fisheries for County Road Maintenance.

## **EC-1.4 STOCKPILE MANAGEMENT**

### **DESCRIPTION**

This activity involves the selection of sites in advance of the need for long-term and short-term stockpiling of materials for road maintenance activities and disposing of excess materials from excavations, grading and culvert basin cleaning. The general watershed criteria for selecting any disposal site is a site where the material will not erode into any part of the channel network, and where it will not initiate a formerly dormant landslide.

### **ENVIRONMENTAL CONCERNS**

- Filling wetlands with spoil material.
- Discharge of sediment, debris, or organic material into the stream or storm water discharge system.
- Destruction or harm to aquatic, riparian or wetland habitat, or to endangered or threatened plant and animal species due to placement of fill material.
- Surface or groundwater impacts from leachate formed in organic material disposal sites.
- Damage to endangered or threatened plant species on site.
- Slope stability of both the disposal site and the spoil pile.

### **BEST MANAGEMENT PRACTICES**

#### **Site Selection**

- Determine the location of existing disposal sites, potential disposal sites, and locations of significant spoil generation along roads.
  - Conduct site investigations of existing and potentially suitable disposal sites. Site investigations should include the disposal area size, distance to watercourses, potential slope instabilities, listed species habitat, archaeological sites, nearby residential areas, access, and other limiting factors.
  - Prepare a map and data set indicating sites (existing and potential) with acceptable site characteristics (see below). Prioritize acceptable sites.
  - Develop site plans for sites adjacent to or near riparian areas or streams to identify erosion and sediment control needs, and to ensure stability of the material.
- Follow these acceptable site characteristics in the site election & design process:
  - Seek a stable site where sediment cannot reach the stream during any high water event.
  - Avoid adjacent riparian corridors or any area within the 100-year floodplain.
  - Avoid all wetland sites as these sites are protected from disposal activities and permits will be required and may not be granted.
  - Avoid placing spoil on unstable slopes, where the added weight could trigger a land movement. Excessive loading of clay or silt soils could also trigger a failure.
  - Use wide, stable locations such as rock pits, ridges, and benches as places to dispose of fill. Avoid locations where ground water emerges or a thick organic layer is present. Do not leave loose soil piled in berms alongside the road or ditch.

- Avoid sites with endangered or threatened plant species. Search the California Natural Diversity Database ([www.dfg.ca.gov/wildab/html/cnddb.html](http://www.dfg.ca.gov/wildab/html/cnddb.html)) for any known listed plant sites in the area. Seek site evaluations by qualified botanists during the appropriate season before selecting a new site.

### **Implementation**

- Locate stockpiles a minimum of 50 ft away from concentrated flows of stormwater, drainage courses, and inlets.
- Protect all stockpiles from stormwater run-on using a temporary perimeter sediment barrier such as berms, dikes, fiber rolls, silt fences, gravel bags, or straw bale barriers.
- During the rainy season, soil stockpiles should be covered or protected with soil stabilization measures and a temporary perimeter sediment barrier at all times.
- During the non-rainy season, soil stockpiles should be covered or protected with a temporary perimeter sediment barrier prior to the onset of precipitation (Figure 1).
- Apply erosion and sediment control BMPs as needed.
- Place bagged materials on pallets and under cover.
- Implement wind erosion control practices as appropriate on all stockpiled material. For specific information.
- The performance of erosion control BMPs should be monitored routinely during construction, especially during and after storm events. BMPs should be maintained or upgraded as needed.
- Manage stockpiles of contaminated soil in accordance with State and Federal Regulations.
- Avoid sidecasting of soil in all cases where it could be delivered into a watercourse, riparian area, roadside ditch or storm drain. Do not sidecast outside of the landowner right-of-way without landowner's permission. In some instances, under the following guidelines (See Table 1), sidecasting is allowable given remote distances from spoils storage sites. In these cases, the setback distance required depends on slope and vegetation. The presence of vegetation helps to slow the travel of sediment downslope, so good judgment is needed to assess the situation. *Do not sidecast at all* if the slope is sparsely vegetated and it appears that sediment will travel with rain runoff into a stream or estuary system, even if setback distances are applied. On slopes of 5:1 (20% gradient) or less, sidecasting is allowed beyond 150 feet of a watercourse, stream crossing, riparian area, roadside ditch or storm drain. On 2:1 slopes (50%) or less, sidecasting is allowed beyond 300 feet of a watercourse, stream crossing, riparian area, roadside ditch or storm drain. On slopes greater than 2:1, typically sidecasting is *not recommended*, however there may be rare instances on slopes greater than 2:1 where sidecasting is acceptable given very long distances from waterbodies and good vegetative cover. Seek advice from local fisheries agency staff when in doubt. Avoid concentrating sidecasting repeatedly in the same place. Never sidecast large amounts of soil from major landslides.

SLOPE GRADIENT	DISTANCE FROM WATERCOURSE, STREAM CROSSING, RIPARIAN AREA, ROADSIDE DITCH, STORM DRAIN	SIDECASTING RULE
Any slope	Appears that sediment will travel with rainwater into watercourse.	Not allowed
5:1 (20%) or less	150 feet or more	Allowed using good judgment
2:1 (50%) or less	300 feet or more	Allowed using good judgment
Greater than 2:1 (50%)	Vegetated slope long distance from watercourse	Allowed
Greater than 2:1 (50%)	Sparsely vegetated slope and it appears that sediment will travel with rain into watercourse	Not allowed

Table 1. Sidecasting BMP. From FishNet 4C (2004).

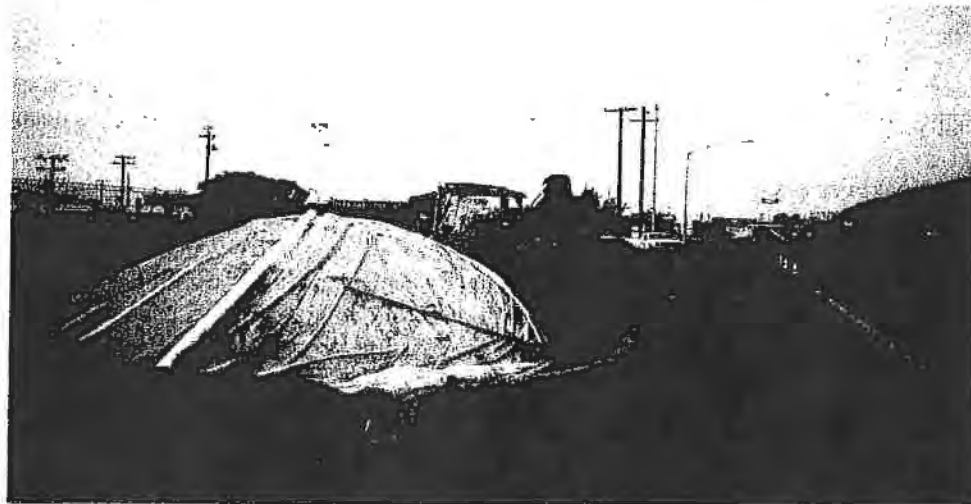

Figure 1. Stock piles should be covered with erosion and sediment control BMPs employed to keep sediment on site. From Caltrans (2003).

**Source Material for Road BMP RD-2.16 Stockpile Management**

2003. California Department of Transportation (CALTRANS). Storm Water Quality Handbooks – Construction Site Best Management Practices (BMPs) Manual.

2004. FishNet 4C. Guidelines for Protecting Aquatic Habitat and Salmon Fisheries for County Road Maintenance.



# Straw Mulch

**SS-6**

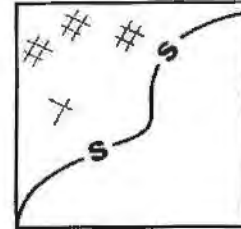

Standard Symbol

- BMP Objectives**
- Soil Stabilization
  - Sediment Control
  - Tracking Control
  - Wind Erosion Control
  - Non-Storm Water Management
  - Materials and Waste Management

**Definition and Purpose** Straw mulch consists of placing a uniform layer of straw and incorporating it into the soil with a studded roller or anchoring it with a stabilizing emulsion. This is one of five temporary soil stabilization alternatives to consider.

**Appropriate Applications**

- Straw mulch is typically used for soil stabilization as a temporary surface cover on disturbed areas until soils can be prepared for revegetation and permanent vegetation is established.
- Also typically used in combination with temporary and/or permanent seeding strategies to enhance plant establishment.

**Limitations**

- Availability of erosion control contractors and straw may be limited prior to the rainy season due to high demand.
- There is a potential for introduction of weed-seed and unwanted plant material.
- When straw blowers are used to apply straw mulch, the treatment areas must be within 45 m (150 ft) of a road or surface capable of supporting trucks.
- Straw mulch applied by hand is more time intensive and potentially costly.
- May have to be removed prior to permanent seeding or soil stabilization.
- “Punching” of straw does not work in sandy soils.

## Straw Mulch

**SS-6**

- Standards and Specifications**
- Straw shall be derived from wheat, rice, or barley.
  - All materials shall conform to Standard Specifications Sections 20-2.06, 20-2.07 and 20-2.11.
  - A tackifier is the preferred method for anchoring straw mulch to the soil on slopes.
  - Crimping, punch roller-type rollers, or track-walking may also be used to incorporate straw mulch into the soil on slopes. Track walking shall only be used where other methods are impractical.
  - Avoid placing straw onto the traveled way, sidewalks, lined drainage channels, sound walls, and existing vegetation.
  - Straw mulch with tackifier shall not be applied during or immediately before rainfall.

### ***Application Procedures***

- Apply loose straw at a minimum rate of 3,570 kg/ha (4,000 lb/ac), or as indicated in the project's special provisions, either by machine or by hand distribution.
- If stabilizing emulsion will be used to anchor the straw mulch in lieu of incorporation, roughen embankment or fill areas by rolling with a crimping or punching-type roller or by track walking before placing the straw mulch. Track walking should only be used where rolling is impractical.
- The straw mulch must be evenly distributed on the soil surface.
- Anchor the mulch in place by using a tackifier or by "punching" it into the soil mechanically (incorporating).
- A tackifier acts to glue the straw fibers together and to the soil surface. The tackifier shall be selected based on longevity and ability to hold the fibers in place.
- A tackifier is typically applied at a rate of 140 kg/ha (125 lb/ac). In windy conditions, the rates are typically 200 kg/ha (178 lb/ac).
- Methods for holding the straw mulch in place depend upon the slope steepness, accessibility, soil conditions and longevity. If the selected method is incorporation of straw mulch into the soil, then do as follows:
  - Applying and incorporating straw shall follow the requirements in Standard Specifications Section 20-3.03.
  - On small areas, a spade or shovel can be used.

### **Best Management Practices for Construction**

Page 2

## Straw Mulch

**SS-6**

- On slopes with soils, which are stable enough and of sufficient gradient to safely support construction equipment without contributing to compaction and instability problems, straw can be “punched” into the ground using a knife-blade roller or a straight bladed coultter, known commercially as a “crimper.”
  - On small areas and/or steep slopes, straw can also be held in place using plastic netting or jute. The netting shall be held in place using 11 gauge wire staples, geotextile pins or wooden stakes. Refer to BMP SS-7, “Geotextiles, Plastic Covers and Erosion Control Blankets/Mats.”
- Maintenance and Inspections
- The key consideration in Maintenance and Inspection is that the straw needs to last long enough to achieve erosion control objectives.
  - Maintain an unbroken, temporary mulched ground cover while DSAs are non-active. Repair any damaged ground cover and re-mulch exposed areas.
  - Reapplication of straw mulch and tackifier may be required by the Resident Engineer (RE) to maintain effective soil stabilization over disturbed areas and slopes.
  - After any rainfall event, the Contractor is responsible for maintaining all slopes to prevent erosion.

### **Source Material for Construction BMP SS-6**

**2003. State of California Department of Transportation. Caltrans Storm Water Quality Handbook Construction Site BMP Manual.**

## Geotextiles, Mats, Plastic Covers and Erosion Control Blankets

**SS-7**

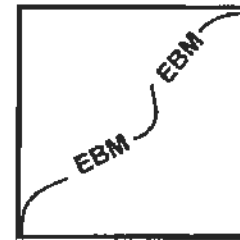
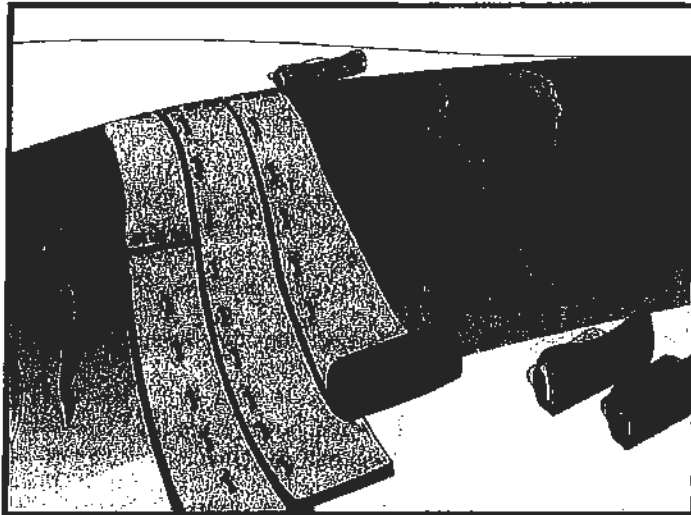

Standard Symbol

### BMP Objectives

- Soil Stabilization
- Sediment Control
- Tracking Control
- Wind Erosion Control
- Non-Storm Water Management
- Materials and Waste Management

**Definition and Purpose** This Best Management Practice (BMP) involves the placement of geotextiles, mats, plastic covers, or erosion control blankets to stabilize disturbed soil areas and protect soils from erosion by wind or water. This is one of five temporary soil stabilization alternatives to consider.

**Appropriate Applications** These measures are used when disturbed soils may be particularly difficult to stabilize, including the following situations:

- Steep slopes, generally steeper than 1:3 (V:H).
- Slopes where the erosion potential is high.
- Slopes and disturbed soils where mulch must be anchored.
- Disturbed areas where plants are slow to develop.
- Channels with flows exceeding 1.0 m/s (3.3 ft/s).
- Channels to be vegetated.
- Stockpiles.
- Slopes adjacent to water bodies of Environmentally Sensitive Areas (ESAs).

## **Geotextiles, Mats, Plastic Covers and Erosion Control Blankets**

---

**SS-7**

- Limitations
- Blankets and mats are more expensive than other erosion control measures, due to labor and material costs. This usually limits their application to areas inaccessible to hydraulic equipment, or where other measures are not applicable, such as channels.
  - Blankets and mats are generally not suitable for excessively rocky sites, or areas where the final vegetation will be mowed (since staples and netting can catch in mowers).
  - Blankets and mats must be removed and disposed of prior to application of permanent soil stabilization measures.
  - Plastic sheeting is easily vandalized, easily torn, photodegradable, and must be disposed of at a landfill.
  - Plastic results in 100% runoff, which may cause serious erosion problems in the areas receiving the increased flow.
  - The use of plastic shall be limited to covering stockpiles, or very small graded areas for short periods of time (such as through one imminent storm event), until alternative measures, such as seeding and mulching, may be installed.
  - Geotextiles, mats, plastic covers, and erosion control covers have maximum flow rate limitations; consult the manufacturer for proper selection.

Standards and  
Specifications

### **Material Selection**

There are many types of erosion control blankets and mats, and selection of the appropriate type shall be based on the specific type of application and site conditions. Selection(s) made by the Contractor must be approved by the Resident Engineer (RE); certification of compliance shall be in accordance with Standard Specifications Section 6-1.07.

### **Site Preparation**

- Proper site preparation is essential to ensure complete contact of the blanket or matting with the soil.
- Grade and shape the area of installation.
- Remove all rocks, clods, vegetation or other obstructions so that the installed blankets or mats will have complete, direct contact with the soil.
- Prepare seedbed by loosening 50 mm (2 in) to 75 mm (3 in) of topsoil.

### **Seeding**

Seed the area before blanket installation for erosion control and revegetation. Seeding after mat installation is often specified for turf reinforcement application. When seeding prior to blanket installation, all check slots and other areas disturbed during installation must be re-seeded. Where soil filling is specified, seed the matting and the entire disturbed area after installation and prior to filling the mat with soil.

## **Geotextiles, Mats, Plastic Covers and Erosion Control Blankets**

**SS-7**

**Maintenance and Inspection** Areas treated with temporary soil stabilization shall be inspected as specified in the special provisions. Areas treated with temporary soil stabilization shall be maintained to provide adequate erosion control. Temporary soil stabilization shall be reapplied or replaced on exposed soils when area becomes exposed or exhibits visible erosion.

- All blankets and mats shall be inspected periodically after installation.
- Installation shall be inspected after significant rain storms to check for erosion and undermining. Any failures shall be repaired immediately.
- If washout or breakage occurs, re-install the material after repairing the damage to the slope or channel.

### **Source Material for Construction BMP SS-7 Geotextiles, Mats, Plastic Covers and Erosion Control Blankets**

**2003. State of California Department of Transportation. Caltrans Storm Water Quality Handbook Construction Site BMP Manual.**

# Outlet Protection/Velocity Dissipation Devices

**SS-10**

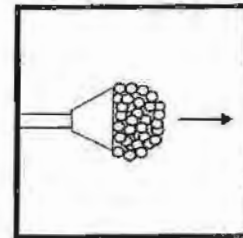

Standard Symbol

**BMP Objectives**

- Soil Stabilization
- Sediment Control
- Tracking Control
- Wind Erosion Control
- Non-Storm Water Management
- Materials and Waste Management

- Definition and Purpose** These devices are placed at pipe outlets to prevent scour and reduce the velocity and/or energy of storm water flows.
- Appropriate Applications**
- These devices may be used at the following locations:
    - Outlets of pipes, drains, culverts, slope drains, diversion ditches, swales, conduits or channels.
    - Outlets located at the bottom of mild to steep slopes.
    - Discharge outlets that carry continuous flows of water.
    - Outlets subject to short, intense flows of water, such as flash floods.
    - Points where lined conveyances discharge to unlined conveyances.
  - This BMP may be implemented on a project-by-project basis with other BMPs when determined necessary and feasible by the Resident Engineer (RE).
- Limitations**
- Loose rock may have stones washed away during high flows.
  - Grouted riprap may break up in areas of freeze and thaw.
  - If there is not adequate drainage, and water builds up behind grouted riprap, it may cause the grouted riprap to break up due to the resulting hydrostatic pressure.

## **Outlet Protection/Velocity Dissipation Devices**

---

**SS-10**

- Standards and Specifications**
- There are many types of energy dissipaters, with rock being the one that is represented in the figure on Page 3. Please note that this is only one example and the RE may approve other types of devices proposed by the contractor.
  - Install riprap, grouted riprap, or concrete apron at selected outlet. Riprap aprons are best suited for temporary use during construction.
  - Carefully place riprap to avoid damaging the filter fabric.
  - For proper operation of apron:
    - Align apron with receiving stream and keep straight throughout its length. If a curve is needed to fit site conditions, place it in upper section of apron.
    - If size of apron riprap is large, protect underlying filter fabric with a gravel blanket.
  - Outlets on slopes steeper than 10% shall have additional protection.
- Maintenance and Inspection**
- Inspect temporary measures prior to the rainy season, after rainfall events, and regularly (approximately once per week) during the rainy season.
  - Inspect apron for displacement of the riprap and/or damage to the underlying fabric. Repair fabric and replace riprap that has washed away.
  - Inspect for scour beneath the riprap and around the outlet. Repair damage to slopes or underlying filter fabric immediately.
  - Temporary devices shall be completely removed as soon as the surrounding drainage area has been stabilized, or at the completion of construction.



# Outlet Protection/Velocity Dissipation Devices

**SS-10**

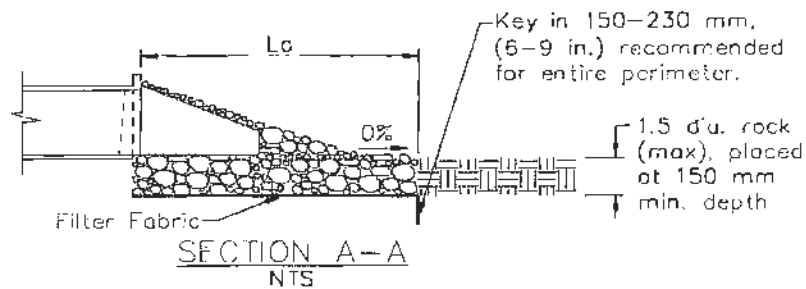
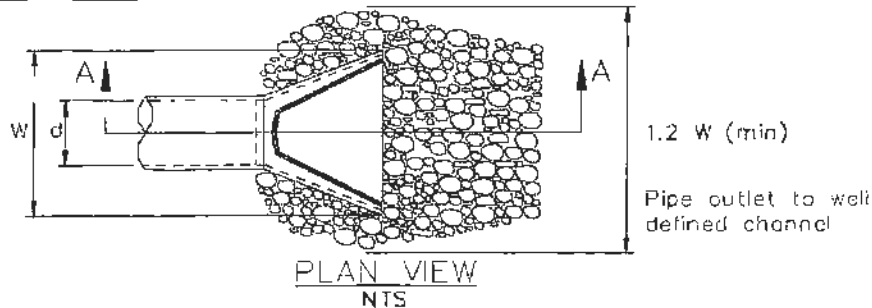

Pipe Diameter mm	Discharge m <sup>3</sup> /s	Apron Length, La m	Rip Rap D <sub>50</sub> Diameter Min mm
300	0.14	3	100
	0.28	4	150
450	0.28	3	150
	0.57	5	200
	0.85	7	300
	1.13	8	400
600	0.85	5	200
	1.13	8	200
	1.42	8	300
	1.70	9	400

For larger or higher flows, consult a Registered Civil Engineer

Source: USDA – SCS

## Source Material for Construction BMP SS-10 Outlet Protection

2003. State of California Department of Transportation. Caltrans Storm Water Quality Handbook Construction Site BMP Manual.

## Slope Drains

**SS-11**

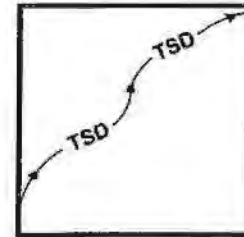
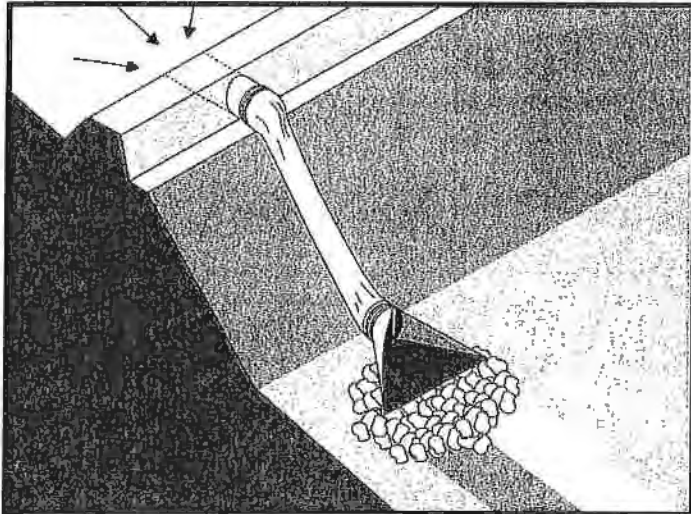

Standard Symbol

### BMP Objectives

- Soil Stabilization
- Sediment Control
- Tracking Control
- Wind Erosion Control
- Non-Storm Water Management
- Materials and Waste Management

**Definition and Purpose** A slope drain is a pipe used to intercept and direct surface runoff or groundwater into a stabilized watercourse, trapping device or stabilized area. Slope drains are used with lined ditches to intercept and direct surface flow away from slope areas to protect cut or fill slopes.

**Appropriate Applications**

- Slope drains may be used on construction sites where slopes may be eroded by surface runoff.
- This BMP may be implemented on a project-by-project basis with other BMPs when determined necessary and feasible by the Resident Engineer (RE).

**Limitations**

- Severe erosion may result when slope drains fail by overtopping, piping, or pipe separation.

**Standards and Specifications**

- When using slope drains, limit drainage area to 4 ha (10 ac) per pipe. For larger areas, use a rock-lined channel or a series of pipes.
- Maximum slope generally limited to 1:2 (V:H), as energy dissipation below steeper slopes is difficult.
- Direct surface runoff to slope drains with interceptor dikes. See BMP SS-8, "Earth Dikes/Drainage Swales, and Lined Ditches."
- Slope drains can be placed on or buried underneath the slope surface.
- Recommended materials are PVC, ABS, or comparable pipe.
- When installing slope drains:
  - Install slope drains perpendicular to slope contours.

## Slope Drains

**SS-11**

- Compact soil around and under entrance, outlet, and along length of pipe.
  - Securely anchor and stabilize pipe and appurtenances into soil.
  - Check to ensure that pipe connections are water tight.
  - Protect area around inlet with filter cloth. Protect outlet with riprap or other energy dissipation device. For high energy discharges, reinforce riprap with concrete or use reinforced concrete device.
  - Protect inlet and outlet of slope drains: use standard flared end section at entrance and exit for pipe slope drains 300 mm (12in) and larger.
- Maintenance and Inspection
- Inspect before and after each rain storm, and twice monthly until the tributary drainage area has been stabilized. Follow routine inspection procedures for inlets thereafter.
  - Inspect outlet for erosion and downstream scour. If eroded, repair damage and install additional energy dissipation measures. If downstream scour is occurring, it may be necessary to reduce flows being discharged into the channel unless other preventative measures are implemented.
  - Inspect slope drainage for accumulations of debris and sediment.
  - Remove built-up sediment from entrances, outlets, and within drains as required.
  - Make sure water is not ponding onto inappropriate areas (e.g., active traffic lanes, material storage areas, etc.).

## Slope Drains

**SS-11**

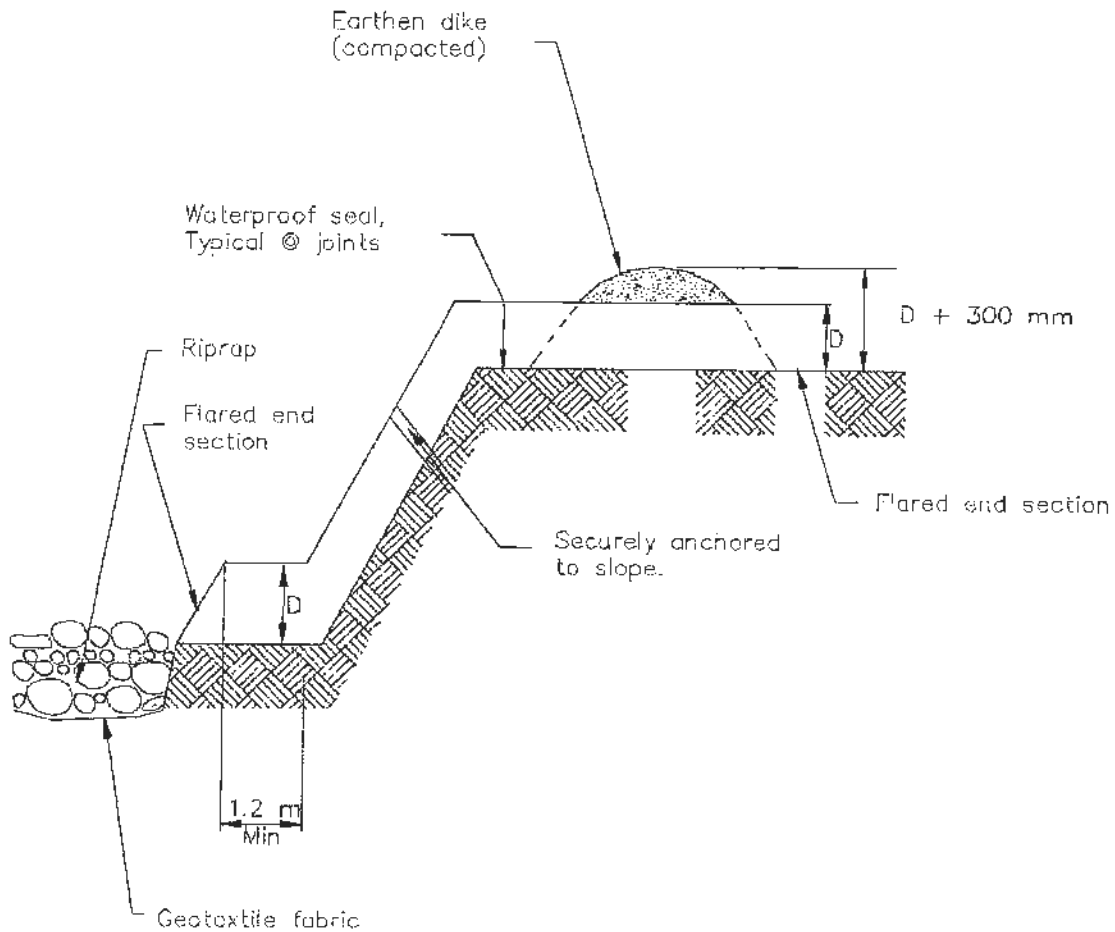

TYPICAL SLOPE DRAIN  
NOT TO SCALE

### Source Material for Construction BMP SS-11 Slope Drains

2003. State of California Department of Transportation. Caltrans Storm Water Quality Handbook Construction Site BMP Manual.

# SC-1.1 CHECK DAMS

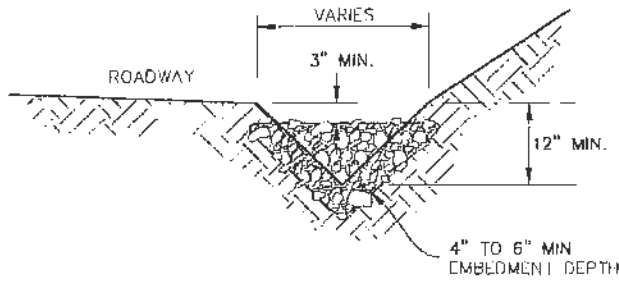

**SECTION VIEW**

- CHECK DAMS:**
1. CHECK DAMS SHALL BE INSTALLED AT ALL LOCATIONS INDICATED ON THE WRPP, AND AT ANY OTHER LOCATION DETERMINED NECESSARY BY THE SITE CONTRACTOR.
  2. CHECK DAMS SHOULD BE SPACED SO THAT THE TOE OF CHECK DAM IS THE SAME ELEVATION AS THE TOP OF THE CHECK DAM BELOW.
  3. CHECK DAMS SHOULD BE IMBEDDED IN CHANNEL A MINIMUM OF 4" - 6"
  4. CHECK DAMS THAT EXCEED A HEIGHT OF 3' SHOULD BE DESIGNED BY A QUALIFIED ENGINEER, GEOLOGIST, OR EROSION CONTROL SPECIALIST
  5. CHECK DAMS SHALL BE INSPECTED PERIODICALLY THROUGHOUT THE COURSE OF CONSTRUCTION, ONCE AFTER EACH RAINFALL EVENT, AND ONCE EVERY 24 HOURS DURING EXTENDED RAINFALL EVENTS. ANY SPLIT, TORN, UNRAVELED OR SLOWING PIER ROLLS SHALL BE REPAIRED OR REPLACED IMMEDIATELY.

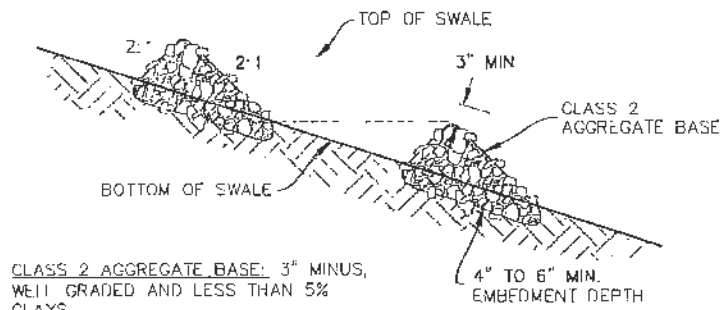

**CHECK DAM SPACING**

CLASS 2 AGGREGATE BASE: 3" MINUS,  
WELL GRADED AND LESS THAN 5%  
CLAYS

# SC1.2 TEMPORARY SEDIMENT BASIN

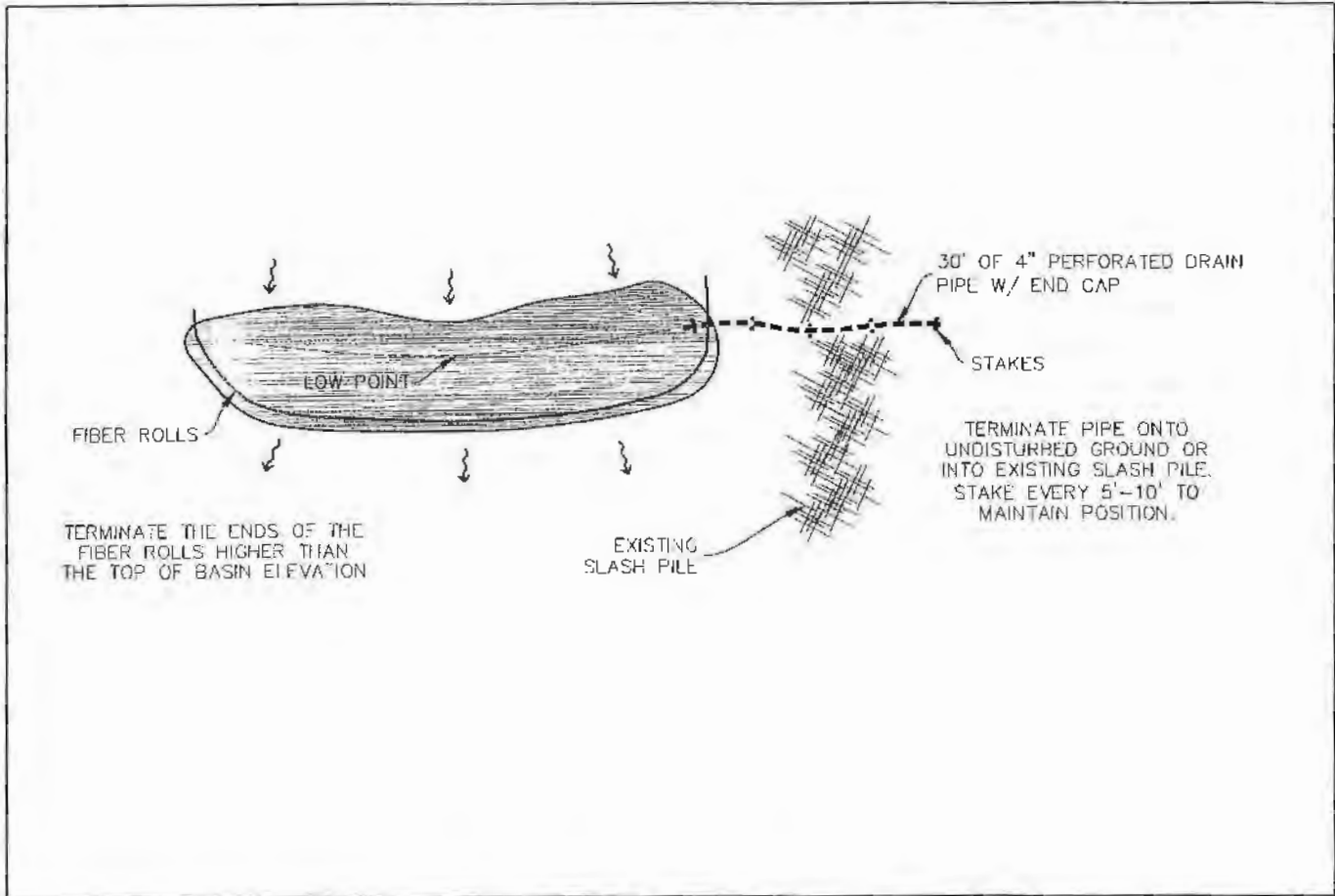

WATER RESOURCE PROTECTION PLAN (WRPP) - *NorthPoint Consulting*

# SC-1.3 FIBER ROLLS

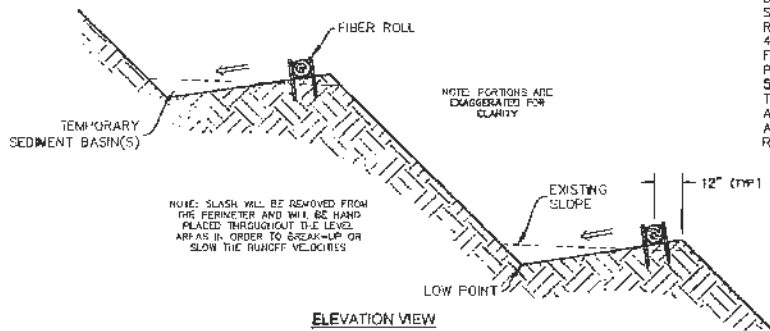
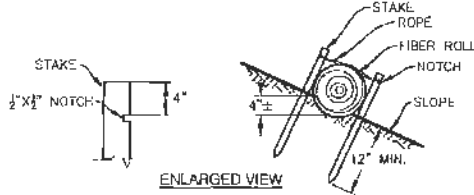
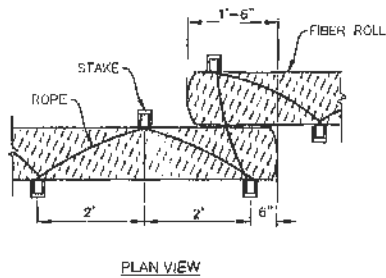

## FIBER ROLLS:

1. FIBER ROLLS SHALL BE INSTALLED AT ALL LOCATIONS INDICATED ON THE WRPP, AND AT ANY OTHER LOCATION DEEMED NECESSARY BY THE SITE CONTRACTOR.
2. FIBER ROLLS SHOULD BE USED ALONG THE FACE OF EXPOSED SLOPES TO SHORTEN SLOPE LENGTH AND DECREASE FLOW VELOCITY; AT GRADE BREAKS WHERE SLOPES TRANSITION TO STEEPER SLOPES; AND ALONG STREAM BANKS TO ASSIST STABILIZATION, AND IN DRAINAGE SWALES TO SLOW FLOWS. ON 1:1 SLOPES PLACE FIBER ROLLS SPACED AT 10' INTERVALS PARALLEL TO SLOPE, ON 1.5:1 SLOPES PLACE FIBER ROLLS SPACED AT 15' INTERVALS PARALLEL TO SLOPE, AND ON 2:1 SLOPES PLACE FIBER ROLLS SPACED AT 20' INTERVALS PARALLEL TO SLOPE.
3. FIBER ROLLS SHALL CONSIST OF BIODEGRADABLE FIBERS STUFFED INTO A PHOTO-DEGRADABLE OPEN WEAVE NETTING. THEY SHALL BE DESIGNED TO ALLOW WATER TO PASS THROUGH THE FIBERS; TO TRAP SUSPENDED SEDIMENT; INCREASE FILTRATION RATES; AND TO SLOW RUNOFF.
4. FIBER ROLLS SHALL BE PLACED SUCH THAT THEY OVERLAP AND FOLLOW THE CONTOUR LINES OF THE SLOPE ON WHICH THEY ARE PLACED.
5. FIBER ROLLS SHALL BE INSPECTED PERIODICALLY THROUGHOUT THE COURSE OF CONSTRUCTION, ONCE AFTER EACH RAINFALL EVENT, AND ONCE EVERY 24 HOURS DURING EXTENDED RAINFALL EVENTS. ANY SPLIT, TORN, UNRAVELED OR SLUMPING FIBER ROLLS SHALL BE REPAIRED OR REPLACED IMMEDIATELY.

WATER RESOURCE PROTECTION PLAN (WRPP) - NorthPoint Consulting

## **ROAD BMP RESOURCES**

### **DESCRIPTION**

Listed below are some of the resource materials for Road BMPs that are available for landowners.

**2006. California Department of Fish and Game. Part X - Upslope Erosion Inventory and Sediment Control Guidance, California Salmonid Stream Habitat Restoration Manual.**

Available at:

California Department of Fish and Game  
Inland Fisheries Division  
ATTN: Salmonid Habitat Restoration Coordinator  
1416 Ninth Street, Sacramento, CA 95814 (916) 654-5997  
or  
[www.dfg.ca.gov/fish/resources/habitatmanual.asp](http://www.dfg.ca.gov/fish/resources/habitatmanual.asp)

**2003. California Department of Transportation (CALTRANS). Storm Water Quality Handbooks – Construction Site Best Management Practices (BMPs) Manual.**

Available at:

[www.dot.ca.gov/hq/construc/stormwater/CSBMPM\\_303\\_Final.pdf](http://www.dot.ca.gov/hq/construc/stormwater/CSBMPM_303_Final.pdf)

**2009. California Stormwater Quality Association (CASQA). California Stormwater BMP Handbook.**

Available at:

California Stormwater Quality Association  
PO Box 2105  
Menlo Park, CA 94026  
or  
[www.cabmphandbooks.com](http://www.cabmphandbooks.com)

**2004. FishNet 4C. Guidelines for Protecting Aquatic Habitat and Salmon Fisheries for County Road Maintenance.**

Available at:

3820 Cypress Dr., Suite 11  
Petaluma, CA 94954 Phone: 707.762.1336  
or  
[http://fishnet.marin.org/projects\\_roads\\_manual.html](http://fishnet.marin.org/projects_roads_manual.html)



## Appendix E: References

1. Humboldt County Web GIS. (2018, May). Humboldt County Planning and Building Department. Retrieved from <http://webgis.co.humboldt.ca.us/HCEGIS2.0/>
2. State of California, Department of Forestry and Fire Protection. (2018, January). *California Forest Practice Rules: Title 14, California code of regulations, chapters 4, 4.5 and 10 with the Z'Berg Nejedley Forest Practice Act, the Professional Foresters law, and the Registration of Professional Foresters Rules*. Sacramento, CA: The California Department of Forestry and Fire Protection.
3. California Natural Diversity Database (CNDDDB) Maps and Data. (2018). California Department of Fish and Wildlife. Retrieved from <https://www.wildlife.ca.gov/Data/CNDDDB/Maps-and-Data#43018408-cnddb-in-bios>
4. State of California, North Coast Regional Water Quality Control Board. (2015, August). *Order No. R1-2015-0023: Waiver of Waste Discharge Requirements and General Water Quality Certification*. Retrieved from [https://www.waterboards.ca.gov/northcoast/board\\_decisions/adopted\\_orders/pdf/2015/15\\_0023\\_Cannabis\\_Order.pdf](https://www.waterboards.ca.gov/northcoast/board_decisions/adopted_orders/pdf/2015/15_0023_Cannabis_Order.pdf)
5. State of California, State Water Resources Control Board. (2017, October). *Cannabis Cultivation Policy: Principles and Guidelines for Cannabis Cultivation*. Retrieved from [https://www.waterboards.ca.gov/board\\_decisions/adopted\\_orders/resolutions/2017/final\\_cannabis\\_policy\\_with\\_att\\_a.pdf](https://www.waterboards.ca.gov/board_decisions/adopted_orders/resolutions/2017/final_cannabis_policy_with_att_a.pdf)
6. State of California, State Water Resources Control Board. (2017, October). *Order No. WQ 2017-0023-DWQ: General Waste Discharge Requirements and Waiver of Waste Discharge Requirements for Discharges of Waste Associated with Cannabis Cultivation Activities*. Retrieved from [https://www.waterboards.ca.gov/water\\_issues/programs/cannabis/docs/finaladoptedcango101717.pdf](https://www.waterboards.ca.gov/water_issues/programs/cannabis/docs/finaladoptedcango101717.pdf)
7. State of California, California Department of Transportation, Division of Environmental Analysis, Stormwater Program. (2017, May). CTSW-RT-17-314.18.1: *Construction Site Best Management Practices (BMP) Manual*. Retrieved from <http://www.dot.ca.gov/hq/construc/stormwater/CSBMP-May-2017-Final.pdf>
8. Weaver, W.E., Weppner, E.M. and Hagans, D.K. (2015, April). *Handbook for Forest, Ranch and Rural Roads: A Guide for Planning, Designing, Constructing, Reconstructing, Upgrading, Maintaining and Closing Wildland Roads*. Ukiah, California: Mendocino County Conservation Resource District.

## **Appendix F: Water Use Record**

Appendix F: Water Diversion, Storage, and Use

SWRCB Cannabis Cultivation Waste Discharge Regulatory Program  
 Site Management Plan  
 Water Diversion, Storage, and Use

Name: Sunny Slope Ranch, LLC (Thadeus Diaz)  
 APN: 208-112-024  
 Year: 2017

Total surface water diversion by source and month (gallons)

Source	Jan	Feb	March	April	May	June	July	Aug	Sept	Oct	Nov	Dec	Total
Point of Diversion (So25008) Domestic and Irrigation Purposes	-	-	-	-	-	-	-	-	-	-	-	-	N/A
Point of Diversion (So25309) Domestic Purposes	-	-	-	-	-	-	-	-	-	-	-	-	N/A
													-

Water input to storage by source and month (gallons)

Source	Jan	Feb	March	April	May	June	July	Aug	Sept	Oct	Nov	Dec	Total
Water Storage Tanks from Rainwater Catchment Pond	4,250	4,250	4,250									4,250	17,000
													17,000

Water use by source and month (gallons)

Use-Source	Jan	Feb	March	April	May	June	July	Aug	Sept	Oct	Nov	Dec	Total
Cannabis-Rainwater Catchment Pond				7,500	20,000	30,000	40,000	50,000	50,000	35,000			232,500
Cannabis from Storage				4,250	4,250	4,250	4,250						17,000
Domestic-Rainwater Catchment Pond	-	-	-	3,600	3,600	3,600	3,600	3,600	3,600	3,600	3,600	3,600	32,400
													281,900

\*Note: data is an approximation and is subject to change upon further analysis.  
 NorthPoint Consulting

## **Appendix G: Fertilizer, Pesticide, Herbicide, and Rodenticide Product List and Records**

**Appendix G: FERTILIZER, PESTICIDE, HERBICIDE, AND RODENTICIDE PRODUCT LIST AND RECORDS**

Type	Brand	N-P-K	Total Nitrogen (lbs) Applied*	Total Phosphorous (lbs) Applied*
Growing Medium/Soil				
Fertilizer, Amendment, Additive	Maxsea: Plant Food	16-16-16	1	1
	Kelp Meal	1-0-2	1	N/A
	Fish Meal	10-4-0	N/A	N/A
	Bat Guano	9-3-1	26	39
	Earth Work Castings	N/A	N/A	N/A
	Green Waste	N/A	N/A	N/A
	Alfalfa Meal	2-1-2	12	6
	Humic Acid	N/A	N/A	N/A
	Glacial Rock Dust	N/A	N/A	N/A
	Aurora-707 Mix	N/A	N/A	N/A
	Royal Gold Mendomix	N/A	N/A	N/A
Pesticide/Herbicide				
			40 lbs	46 lbs

\*Applied during 2017



## **Appendix H: Monthly BPTC Monitoring and Maintenance Records**

**Appendix H: Monthly BPTC Monitoring and Maintenance Records**

Monitoring Data Sheet for SWRCB Cannabis Regulatory Program  
(BPTC Effectiveness Monitoring)

Inspector(s): \_\_\_\_\_

Date: \_\_\_\_\_

Owner: \_\_\_\_\_

APN: \_\_\_\_\_

Inspection Period (Circle)      < Oct 15,      < Dec 15,      0.5 in/day or 1 in/7 days

Other: \_\_\_\_\_

Map Point	BPTC	*Condition: G/M/R	Comment

\* **G** - Good Condition (working as designed), **M** - Maintenance (needs maintenance to work properly), **R** - Replacement (needs to be reconstructed)

*Site Management Plan for Sunny Slope Ranch, LLC.  
In fulfillment of the SWRCB General Waste Discharge Requirements and Waiver of Waste Discharge  
Requirements for Discharges of Waste Associated with Cultivation Activities  
Order WQ 2017-0023-DWQ & NCRWQCB Order No. 2015-0023*





## **Appendix I: SDUR Certificate**



**STATE OF CALIFORNIA  
CALIFORNIA ENVIRONMENTAL PROTECTION AGENCY  
STATE WATER RESOURCES CONTROL BOARD**

**DIVISION OF WATER RIGHTS**

**RIGHT TO DIVERT AND USE WATER**

REGISTRATION D032480

CERTIFICATE D961

Right Holder: Thadeus Diaz  
369 Church Lane  
Carlotta, CA 95528

The State Water Resources Control Board (State Water Board) authorizes the diversion and use of water by the right holder in accordance with the limitations and conditions herein SUBJECT TO PRIOR RIGHTS. The priority of this right dates from **July 8, 2015**. This right is issued in accordance with the State Water Board delegation of authority to the Deputy Director for Water Rights (Resolution 2012-0029) and the Deputy Director for Water Rights redelegation of authority dated July 6, 2012. The Deputy Director for Water Rights finds that this registration meets the requirements for registration of small domestic use appropriation. (Wat. Code, § 1228 et seq.)

**Right holder is hereby granted a right to divert and use water as follows:**

1. Source of water: **Unnamed Stream**

tributary to: **Larabee Creek thence Van Duzen River thence Eel River**

within the County of **Humboldt**.

2. Location of point of diversion

By California Coordinate System of 1983 in Zone 1	County	Assessor's Parcel Number
<b>North 2,060,795 feet and East 6,072,957 feet</b>	<b>Humboldt</b>	<b>208-112-024</b>

Location of place of storage

By California Coordinate System of 1983 in Zone 1	County	Assessor's Parcel Number
<b>N/A</b>	<b>Humboldt</b>	<b>208-112-024</b>

3. Purpose of use	4. Place of use	
	County	Assessor's Parcel Number
<b>Domestic and Fire Protection</b>	<b>Humboldt</b>	<b>208-112-024</b>

The place of use is shown on map on file with the State Water Board.

5. The water appropriated shall be limited to the quantity which can be beneficially used and shall not exceed **240 gallons per day** by direct diversion from November 13 of each year to June 14 of the succeeding year and **0.12 acre-foot per year** by storage from December 15 of each year to May 31 of the succeeding year. The capacity of the reservoir shall not exceed 0.83 acre-feet. The total amount of water taken from the source (direct diversion plus collection to storage) under this right shall not exceed **0.28 acre-foot per year**.
6. No water shall be diverted or used under this right, and no construction related to such diversion shall commence, unless the right holder has obtained and is in compliance with all necessary permits or other approvals required by other agencies.
7. Diversion works shall be constructed and water applied to beneficial use with due diligence.
8. No water shall be diverted under this right unless the right holder complies with all lawful conditions required by the California Department of Fish and Wildlife. (Wat. Code, § 1228.6, subd. (a)(2).)
9. No water shall be diverted under this right unless it is diverted in accordance with the information set forth in the completed registration form as to source, location of point of diversion, purpose of use, place of use, and quantity and season of diversion. This information is reproduced as conditions 1 through 5 of this certificate.
10. No water shall be diverted under this right for irrigating any commercial crop (e.g. crop grown for sale or trade), or for irrigating more than one-half acre of lawn, ornamental shrubbery, or gardens not associated with an establishment within the place of use.
11. Pursuant to Water Code sections 100 and 275 and the common law public trust doctrine, all rights and privileges under this right, including method of diversion, method of use, and quantity of water diverted, are subject to the continuing authority of the State Water Board in accordance with law and in the interest of the public welfare to protect public trust uses and to prevent waste, unreasonable use, unreasonable method of use, or unreasonable method of diversion of said water.
12. Right holder shall grant, or secure authorization through the right holder's right of access to property owned by another party, the staff of the State Water Board, and any other authorized representatives of the State Water Board the following:
  - a. Entry upon property where water is being diverted, stored or used under a right issued by the State Water Board or where monitoring, samples and/or records must be collected under the conditions of this right;
  - b. Access to copy any records at reasonable times that are kept under the terms and conditions of a right or other order issued by State Water Board;
  - c. Access to inspect at reasonable times any project covered by a right issued by the State Water Board, equipment (including monitoring and control equipment), practices, or operations regulated by or required under this right; and,
  - d. Access to photograph, sample, measure, and monitor at reasonable times for the purpose of ensuring compliance with a right or other order issued by State Water Board, or as otherwise authorized by the Water Code.

13. Diversion of water under this right is subject to prior rights. Right holder may be required to curtail diversion or release water stored during the most recent collection season should diversion under this right result in injury to holders of legal downstream senior rights. If a reservoir is involved, the right holder may be required to bypass or release water through, over, or around the dam. If release of stored water would not effectively satisfy downstream prior storage rights, the right holder may be required to otherwise compensate the holders of such rights for injury caused.
14. This right shall not be construed as conferring right of access to any lands or facilities not owned by the right holder.
15. All rights are issued subject to available flows. Inasmuch as the source contains treated wastewater, imported water from another stream system, or return flow from other projects, there is no guarantee that such supply will continue.
16. If storage or diversion of water under this right is by means of a dam, the right holder shall allow sufficient water at all times to pass through a fishway or, in the absence of a fishway, allow sufficient water to pass over, around, or through the dam to keep in good condition any fish that may be planted or exist below the dam; provided that, during a period of low flow in the stream, upon approval of the California Department of Fish and Wildlife, this requirement will be satisfied if sufficient water is passed through a culvert, waste gate, or over or around the dam to keep in good condition any fish that may be planted or exist below the dam if it is impracticable or detrimental to pass the water through a fishway. In the case of a reservoir, this provision shall not require the passage or release of water at a greater rate than the unimpaired natural inflow into the reservoir. (Fish & G. Code, § 5937.)
17. The facilities for diversion under this right shall include satisfactory means of measuring and bypassing sufficient water to satisfy downstream prior rights and any requirements of the California Department of Fish and Wildlife.
18. This right does not authorize any act which results in the taking of a threatened, endangered or candidate species or any act which is now prohibited, or becomes prohibited in the future, under either the California Endangered Species Act (Fish and Game Code section 2050 et seq.) or the federal Endangered Species Act (16 U.S.C.A. section 1531 et seq.). If a "take" will result from any act authorized under this water right, the right holder shall obtain authorization for an incidental take prior to construction or operation of the project. Right holder shall be responsible for meeting all requirements of the state and Federal Endangered Species Acts for the project authorized under this right.
19. No water shall be diverted under this right unless the right holder complies with the reporting, measuring, and monitoring requirements of Chapters 2.7 and 2.8 of Division 3 of Title 23 of the California Code of Regulations. If there is any conflict or inconsistency between these regulations and the conditions in this right for reporting, measuring, and monitoring the diversion and use of water, the more stringent requirement or requirements shall control in each instance.
20. This right is subject to renewal prior to the expiration of each five-year period following the priority date of this right. This right shall be renewed only if the right holder has paid the renewal fee and properly reported the diversion and use of water under this right in accordance with the requirements of the State Water Board. This right shall be revoked upon failure of the right holder to renew the right as required by the conditions of this certificate. (Wat. Code, § 1228.5.)

21. Right holder is on notice that any of the following may be cause for the State Water Board to consider revocation (including partial revocation) of this right: (1) failure to timely commence or complete construction work or beneficial use of water with due diligence; (2) cessation or partial cessation of beneficial use of water; (3) failure to observe any of the terms or conditions of this right; or (4) a finding by the State Water Board that the right holder knowingly made a false statement or knowingly concealed any material fact in the registration. (Wat. Code, § 1228.4.)

STATE WATER RESOURCES CONTROL BOARD

ORIGINAL SIGNED BY  
ROBERT CERVANTES FOR:

*Erik Ekduhl, Deputy Director  
Division of Water Rights*

Dated: MAR 01 2018

HUMBOLDT COUNTY DEPARTMENT OF PUBLIC WORKS  
ROAD EVALUATION REPORT



**PART A:** *Part A may be completed by the applicant*

Applicant Name: THADDEUS DIAZ APN: 208-112-024

Planning & Building Department Case/File No.: CUP 16-221

Road Name: Access Rd. to 26980 residence. (complete a separate form for each road)

From Road (Cross street): Hywy 36.

To Road (Cross street): Driveway of residence

Length of road segment: 1.0 miles Date Inspected: 4-23-18

Road is maintained by:  County  Other Private  
(State, Forest Service, National Park, State Park, BLM, Private, Tribal, etc)

Check one of the following:

- Box 1**  The entire road segment is developed to Category 4 road standards (20 feet wide) or better. If checked, then the road is adequate for the proposed use without further review by the applicant.
- Box 2**  The entire road segment is developed to the equivalent of a road category 4 standard. If checked, then the road is adequate for the proposed use without further review by the applicant.

*An equivalent road category 4 standard is defined as a roadway that is generally 20 feet in width, but has pinch points which narrow the road. Pinch points include, but are not limited to, one-lane bridges, trees, large rock outcroppings, culverts, etc. Pinch points must provide visibility where a driver can see oncoming vehicles through the pinch point which allows the oncoming vehicle to stop and wait in a 20 foot wide section of the road for the other vehicle to pass.*

- Box 3**  The entire road segment is not developed to the equivalent of road category 4 or better. The road may or may not be able to accommodate the proposed use and further evaluation is necessary. Part B is to be completed by a Civil Engineer licensed by the State of California.

The statements in PART A are true and correct and have been made by me after personally inspecting and measuring the road.

Signature

Tad Diaz

Date

4-23-18

Name Printed

TAD DIAZ

Important: Read the instructions before using this form. If you have questions, please call the Dept. of Public Works Land Use Division at 707.445.7205.

**PART B: Only complete Part B if Box 3 is checked in Part A. Part B is to be completed by a Civil Engineer licensed by the State of California. Complete a separate form for each road.**

Road Name: \_\_\_\_\_ Date Inspected: \_\_\_\_\_ APN: \_\_\_\_\_  
 From Road: \_\_\_\_\_ (Post Mile \_\_\_\_\_ ) Planning & Building  
 To Road: \_\_\_\_\_ (Post Mile \_\_\_\_\_ ) Department Case/File No.: \_\_\_\_\_

1. What is the Average Daily Traffic (ADT) of the road (including other known cannabis projects)?

Number of other known cannabis projects included in ADT calculations: \_\_\_\_\_  
 (Contact the Planning & Building Department for information on other nearby projects.) \_\_\_\_\_

ADT: \_\_\_\_\_ Date(s) measured: \_\_\_\_\_

Method used to measure ADT:  Counters  Estimated using ITE Trip Generation Book

Is the ADT of the road less than 400?  Yes  No

If YES, then the road is considered very low volume and shall comply with the design standards outlined in the American Association of State Highway and Transportation Officials (AASHTO) *Guidelines for Geometric Design of Very Low-Volume Local Roads (ADT ≤400)*. Complete sections 2 and 3 below.

If NO, then the road shall be reviewed per the applicable policies for the design of local roads and streets presented in AASHTO *A Policy on Geometric Design of Highways and Streets*, commonly known as the "Green Book". Complete section 3 below.

2. Identify site specific safety problems with the road that include, but are not limited to: (Refer to Chapter 3 in AASHTO *Guidelines for Geometric Design of Very Low-Volume Local Roads (ADT ≤400)* for guidance.)

A. Pattern of curve related crashes.

Check one:  No.  Yes, see attached sheet for Post Mile (PM) locations.

B. Physical evidence of curve problems such as skid marks, scarred trees, or scarred utility poles

Check one:  No.  Yes, see attached sheet for PM locations.

C. Substantial edge rutting or encroachment.

Check one:  No.  Yes, see attached sheet for PM locations.

D. History of complaints from residents or law enforcement.

Check one:  No.  Yes ( check if written documentation is attached)

E. Measured or known speed substantially higher than the design speed of the road (20+ MPH higher)

Check one:  No.  Yes.

F. Need for turn-outs.

Check one:  No.  Yes, see attached sheet for PM locations.

3. Conclusions/Recommendations per AASHTO. Check one:

The roadway can accommodate the cumulative increased traffic from this project and all known cannabis projects identified above.

The roadway can accommodate the cumulative increased traffic from this project and all known cannabis projects identified above, if the recommendations on the attached report are done. ( check if a *Neighborhood Traffic Management Plan* is also required and is attached.)

The roadway cannot accommodate increased traffic from the proposed use. It is not possible to address increased traffic.

A map showing the location and limits of the road being evaluated in PART B is attached. The statements in PART B are true and correct and have been made by me after personally evaluating the road.

Signature of Civil Engineer \_\_\_\_\_

Date \_\_\_\_\_

(N/A)

Important: Read the instructions before using this form. If you have questions, please call the Dept. of Public Works Land Use Division at 707.445.7205.



F&W ; TRIBE

CALIFORNIA DEPARTMENT OF FISH AND WILDLIFE  
REGION 1 – NORTHERN REGION  
619 Second Street  
Eureka, CA 95501

RECEIVED

JUL 18 2016

CDFW - EUREKA



**STREAMBED ALTERATION AGREEMENT**

NOTIFICATION No. 1600-2016-0003-R1

Unnamed Tributary, Tributary to Little Larabee Creek, Tributary to the Van Duzen River, Tributary to the Eel River and the Pacific Ocean

Mr. Thaddeus Diaz  
Water Diversion, Pond Maintenance and Spillway Installation  
3 Encroachments

This Streambed Alteration Agreement (Agreement) is entered into between the California Department of Fish and Wildlife (CDFW) and Mr. Thaddeus Diaz (Permittee).

**RECITALS**

WHEREAS, pursuant to Fish and Game Code (FGC) section 1602, the Permittee initially notified CDFW on January 5, 2016, with fees paid in full on February 26, 2016, that the Permittee intends to complete the project described herein.

WHEREAS, pursuant to FGC section 1603, CDFW has determined that the project could substantially adversely affect existing fish or wildlife resources and has included measures in the Agreement necessary to protect those resources.

WHEREAS, the Permittee has reviewed the Agreement and accepts its terms and conditions, including the measures to protect fish and wildlife resources.

NOW THEREFORE, the Permittee agrees to complete the project in accordance with the Agreement.

**PROJECT LOCATION**

The project to be completed is located within the Little Larabee Creek watershed, approximately 2.2 miles east/northeast of the town of Bridgeville, County of Humboldt, and State of California. The project is located in Section 8, T1N, R4E, Humboldt Base and Meridian; in the Bridgeville U.S. Geological Survey 7.5-minute quadrangle; Assessor's Parcel Number 208-112-24; latitude 40.4738 N and longitude 123.7563 W at the Points of Diversion (POD), and latitude 40.4718 N and longitude 123.7560 W at the pond.

**PROJECT DESCRIPTION**

The project is limited to three encroachments. The project will include water diversion from a Class II stream, installation of a pond overflow that includes placement of an 18"

culvert, and anchoring of the existing pond liner. The project will be conducted to improve water storage infrastructure for domestic use and irrigation.

## **PROJECT IMPACTS**

Existing fish or wildlife resources the project could substantially adversely affect include: Chinook salmon (*Oncorhynchus tshawytscha*), coho salmon (*O. kisutch*), steelhead trout (*O. mykiss*), amphibians, reptiles, aquatic invertebrates, mammals, birds, and other aquatic and riparian species.

The adverse effects the project could have on the fish or wildlife resources identified above include:

### **Impacts to bed, channel, or bank and effects on habitat structure:**

soil compaction or other disturbance to soil layer;  
temporary increase in fine sediment transport;

### **Impacts to water quality:**

increased water temperature;  
reduced instream flow;  
temporary increased turbidity;

### **Impacts to natural flow and effects on habitat structure and process:**

cumulative effect when other diversions on the same stream are considered;  
diversion of flow from activity site;  
direct and/or incidental take;  
water quality degradation; and  
damage to aquatic habitat and function.

## **MEASURES TO PROTECT FISH AND WILDLIFE RESOURCES**

### **1. Administrative Measures**

The Permittee shall meet each administrative requirement described below.

- 1.1 Documentation at Project Site. The Permittee shall make the Agreement, any extensions and amendments to the Agreement, and all related notification materials and California Environmental Quality Act (CEQA) documents, readily available at the project site at all times and shall be presented to CDFW personnel, or personnel from another state, federal, or local agency upon request.
- 1.2 Providing Agreement to Persons at Project Site. The Permittee shall provide copies of the Agreement and any extensions and amendments to the Agreement to all persons who will be working on the project at the project site on behalf of the Permittee, including but not limited to contractors, subcontractors, inspectors, and monitors.

- 1.3 Adherence to Existing Authorizations. All water diversion facilities that the Permittee owns, operates, or controls shall be operated and maintained in accordance with current law and applicable water rights.
- 1.4 Change of Conditions and Need to Cease Operations. If conditions arise, or change, in such a manner as to be considered deleterious to the stream or wildlife by CDFW, operations shall cease until corrective measures approved by CDFW are taken. This includes new information becoming available that indicates that the bypass flows and diversion rates provided in this agreement are not providing adequate protection to keep aquatic life downstream in good condition or to avoid "take" or "incidental take" of federal or State listed species.
- 1.5 Notification of Conflicting Provisions. The Permittee shall notify CDFW if the Permittee determines or learns that a provision in the Agreement might conflict with a provision imposed on the project by another local, state, or federal agency. In that event, CDFW shall contact the Permittee to resolve any conflict.
- 1.6 Project Site Entry. The Permittee agrees to allow CDFW employees access to any property it owns and/or manages for the purpose of inspecting and/or monitoring the activities covered by this Agreement, provided CDFW: a) provides 24 hours advance notice; and b) allows the Permittee or representatives to participate in the inspection and/or monitoring. This condition does not apply to CDFW enforcement personnel.

## **2. Avoidance and Minimization Measures**

To avoid or minimize adverse impacts to fish and wildlife resources identified above, the Permittee shall implement each measure listed below.

- 2.1 Permitted Project Activities. Except where otherwise stipulated in this Agreement, all work shall be in accordance with the Permittee Notification received with fees paid in full on January 5, 2016, together with all maps, BMP's, photographs, drawings, and other supporting documents submitted with the Notification.

### **Water Diversion**

- 2.2 Maximum Diversion Rate. The maximum instantaneous diversion rate for consumptive use from the water intake shall not exceed 5 gallon per minute. The instantaneous diversion rate shall not exceed 20% of the total flow at any time. This condition is subject to modification should further analysis warranting such action become available at a later date.
- 2.3 Bypass Flow. The Permittee shall pass sufficient flow at all times to keep all aquatic species including fish and other aquatic life in good condition below the point of diversion.

- 2.4 Water Conservation. The Permittee shall add sufficient water storage and/or water conservation measures by May 15, 2016, to limit diverting spring flow to no more than 200 gallons per day from May 15 to October 15 of each year beginning in 2016. The Permittee shall make best efforts to minimize water use, and to follow best practices for water conservation and management.
- 2.5 Intake Structure. No polluting materials (e.g., particle board, plastic sheeting, bentonite) shall be used to construct or screen, or cover the diversion intake structure.
- 2.6 Intake Shall Not Impede Aquatic Species Passage. The water diversion structures shall be designed, constructed, and maintained such that they do not constitute a barrier to upstream or downstream movement of aquatic life.
- 2.7 Water Storage Maintenance. Storage tanks shall have a float valve to shut off the diversion when tanks are full to prevent overflow from being diverted when not needed. The Permittee shall install any other measures necessary to prevent overflow of tanks resulting in more water being diverted than is used.
- 2.8 Water Management Plan. The Permittee shall submit a Water Management Plan that describes how water conservation measures will be achieved under this Agreement. The Water Management Plan shall include details on water storage, water conservation, or other relevant material to meet the 200 gallon per day water diversion limit during the period May 15 to October 15 and meet the bypass flow requirements. The Water Management Plan shall include a brief narrative describing water use on the property, photographs to support the narrative, and water use calculations to ensure compliance with this Agreement. **The Water Management Plan shall be submitted by June 15, 2016, to CDFW at the 619 Second Street, Eureka, CA 95501.**
- 2.9 State Water Code. This Agreement does not constitute a valid water right. The Permittee shall comply with State Water Code sections 5100 and 1200 et seq. as appropriate for the water diversion and water storage. The application for this registration is found at:  
[http://www.swrcb.ca.gov/waterrights/publications\\_forms/forms/docs/sdu\\_registration.pdf](http://www.swrcb.ca.gov/waterrights/publications_forms/forms/docs/sdu_registration.pdf).

### **Pond Maintenance and Overflow Installation**

- 2.10 Work Period. All work shall be confined to the period June 1 through October 1 of each year. Work within the active channel of a stream shall be restricted to periods of **no stream flow and dry weather**. Precipitation forecasts and potential increases in stream flow shall be considered when planning construction activities. Construction activities shall cease and all necessary erosion control measures shall be implemented prior to the onset of precipitation.

- 2.11 Vegetation Disturbance. Vegetation disturbance shall not exceed the minimum necessary to perform the work.
- 2.12 Bank Stabilization. The Permittee shall construct bank stabilization with suitable non-erodible materials that will withstand wash out. The bank stabilization material shall extend above the normal high-water mark. No debris or deleterious material shall be used as bank stabilization.
- 2.13 Excavated Fill. Excavated fill material shall be placed in locations where it cannot deliver to a watercourse. To minimize the potential for material to enter the watercourse during the winter period, all excavated and relocated fill material shall be tractor contoured (to drain water) and tractor compacted to effectively incorporate and stabilize loose material into existing road and/or landing features.
- 2.14 Rock Armor Placement.
- 2.14.1 No heavy equipment shall enter the wetted stream channel.
- 2.14.2 No fill material, other than clean rock and river-run gravel backfill, shall be placed in the stream channel.
- 2.14.3 Rock shall be sized to withstand washout from high stream flows, and extend above the ordinary high water level.
- 2.14.4 Rock placed in the wetted stream channel shall be carefully placed to minimize disturbance, and to allow aquatic species to move out of the placement area
- 2.14.5 Rock armoring shall not constrict the natural stream channel width and shall be keyed into a footing trench with a depth sufficient to prevent instability.
- 2.15 Runoff from Steep Areas. The Permittee shall make preparations so that runoff from steep, erodible surfaces will be diverted into stable areas with little erosion potential or contained behind erosion control structures. Erosion control structures such as straw bales and/or siltation control fencing shall be placed and maintained until the threat of erosion ceases. Frequent water checks shall be placed on dirt roads, cat tracks, or other work trails to control erosion.
- 2.16 Stream Protection. No debris, soil, silt, sand, bark, slash, sawdust, rubbish, cement or concrete washings, oil or petroleum products, or other deleterious material from project activities shall be allowed to enter into or be placed where it may be washed by rainfall or runoff into the stream. All project materials and debris shall be removed from the project site and properly disposed of off-site upon project completion.
- 2.17 Equipment Maintenance. Refueling of machinery or heavy equipment, or adding or draining oil, lubricants, coolants or hydraulic fluids shall not take place within

stream bed, channel and bank. All such fluids and containers shall be disposed of properly off-site. Heavy equipment used or stored within stream bed, channel and bank shall use drip pans or other devices (e.g., absorbent blankets, sheet barriers or other materials) as needed to prevent soil and water contamination.

- 2.18 Hazardous Spills. Any material, which could be hazardous or toxic to aquatic life and enters a stream (i.e. a piece of equipment tipping-over in a stream and dumping oil, fuel or hydraulic fluid), the Permittee shall immediately notify the California Emergency Management Agency State Warning Center at 1-800-852-7550, and immediately initiate clean-up activities. CDFW shall be notified by the Permittee within 24 hours at 707-445-6493 and consulted regarding clean-up procedures.

### 3. Reporting Measures

- 3.1 Measurement of Diverted Flow. The Permittee shall install a device acceptable to CDFW for measuring the quantity of water diverted to and from the storage system. Alternatively, the Permittee can record the frequency of pumping and the time to fill storage. This measurement shall begin as soon as this Agreement is signed by the Permittee. The Permittee shall record the quantity of water pumped to and from the system on a weekly basis. The **water diversion records** shall be provided to CDFW at the 619 Second Street, Eureka, CA 95501 office no **later than December 31 of each year beginning in 2016**.

### CONTACT INFORMATION

Written communication that the Permittee or CDFW submits to the other shall be delivered to the address below unless the Permittee or CDFW specifies otherwise.

To Permittee:

Mr. Thaddeus Diaz  
369 Church Lane  
Carlotta, CA 95528  
707-768-3695

To CDFW:

Department of Fish and Wildlife  
Northern Region  
619 Second Street  
Eureka, California 95501  
Attn: Lake and Streambed Alteration Program  
Notification #1600-2016-0003-R1

## **LIABILITY**

The Permittee shall be solely liable for any violation of the Agreement, whether committed by the Permittee or any person acting on behalf of the Permittee, including its officers, employees, representatives, agents or contractors and subcontractors, to complete the project or any activity related to it that the Agreement authorizes.

This Agreement does not constitute CDFW's endorsement of, or require the Permittee to proceed with the project. The decision to proceed with the project is the Permittee's alone.

## **SUSPENSION AND REVOCATION**

CDFW may suspend or revoke in its entirety this Agreement if it determines that the Permittee or any person acting on behalf of the Permittee, including its officers, employees, representatives, agents, or contractors and subcontractors, is not in compliance with the Agreement.

Before CDFW suspends or revokes the Agreement, it shall provide the Permittee written notice by certified or registered mail that it intends to suspend or revoke. The notice shall state the reason(s) for the proposed suspension or revocation, provide the Permittee an opportunity to correct any deficiency before CDFW suspends or revokes the Agreement, and include instructions to the Permittee, if necessary, including but not limited to a directive to immediately cease the specific activity or activities that caused CDFW to issue the notice.

## **ENFORCEMENT**

Nothing in the Agreement precludes CDFW from pursuing an enforcement action against the Permittee instead of, or in addition to, suspending or revoking the Agreement.

Nothing in the Agreement limits or otherwise affects CDFW's enforcement authority or that of its enforcement personnel.

## **OTHER LEGAL OBLIGATIONS**

This Agreement does not relieve the Permittee or any person acting on behalf of the Permittee, including its officers, employees, representatives, agents, or contractors and subcontractors, from obtaining any other permits or authorizations that might be required under other federal, state, or local laws or regulations before beginning the project or an activity related to it.

This Agreement does not relieve the Permittee or any person acting on behalf of the Permittee, including its officers, employees, representatives, agents, or contractors and subcontractors, from complying with other applicable statutes in the FGC including, but not limited to, FGC sections 2050 *et seq.* (threatened and endangered species), 3503 (bird nests and eggs), 3503.5 (birds of prey), 5650 (water pollution), 5652 (refuse disposal into water), 5901 (fish passage), 5937 (sufficient water for fish), and 5948 (obstruction of stream).

Nothing in the Agreement authorizes the Permittee or any person acting on behalf of the Permittee, including its officers, employees, representatives, agents, or contractors and subcontractors, to trespass.

## **AMENDMENT**

CDFW may amend the Agreement at any time during its term if CDFW determines the amendment is necessary to protect an existing fish or wildlife resource.

The Permittee may amend the Agreement at any time during its term, provided the amendment is mutually agreed to in writing by CDFW and the Permittee. To request an amendment, the Permittee shall submit to CDFW a completed CDFW "Request to Amend Lake or Streambed Alteration" form and include with the completed form payment of the corresponding amendment fee identified in CDFW's current fee schedule (see Cal. Code Regs., tit. 14, § 699.5).

## **TRANSFER AND ASSIGNMENT**

This Agreement may not be transferred or assigned to another entity, and any purported transfer or assignment of the Agreement to another entity shall not be valid or effective, unless the transfer or assignment is requested by the Permittee in writing, as specified below, and thereafter CDFW approves the transfer or assignment in writing.

The transfer or assignment of the Agreement to another entity shall constitute a minor amendment, and therefore to request a transfer or assignment, the Permittee shall submit to CDFW a completed CDFW "Request to Amend Lake or Streambed Alteration" form and include with the completed form payment of the minor amendment fee identified in CDFW's current fee schedule (see Cal. Code Regs., tit. 14, § 699.5).

## **EXTENSIONS**

In accordance with FGC section 1605(b), the Permittee may request one extension of the Agreement, provided the request is made prior to the expiration of the Agreement's term. To request an extension, the Permittee shall submit to CDFW a completed CDFW "Request to Extend Lake or Streambed Alteration" form and include with the completed form payment of the extension fee identified in CDFW's current fee schedule



(see Cal. Code Regs., tit. 14, § 699.5). CDFW shall process the extension request in accordance with FGC 1605(b) through (e).

If the Permittee fails to submit a request to extend the Agreement prior to its expiration, the Permittee must submit a new notification and notification fee before beginning or continuing the project the Agreement covers (FGC section 1605(f)).

## **EFFECTIVE DATE**

The Agreement becomes effective on the date of CDFW's signature, which shall be: 1) after the Permittee signature; 2) after CDFW complies with all applicable requirements under the California Environmental Quality Act (CEQA); and 3) after payment of the applicable FGC section 711.4 filing fee listed at [http://www.wildlife.ca.gov/habcon/ceqa/ceqa\\_changes.html](http://www.wildlife.ca.gov/habcon/ceqa/ceqa_changes.html).

## **TERM**

This Agreement shall **expire five years** from date of execution, unless it is terminated or extended before then. All provisions in the Agreement shall remain in force throughout its term. The Permittee shall remain responsible for implementing any provisions specified herein to protect fish and wildlife resources after the Agreement expires or is terminated, as FGC section 1605(a)(2) requires.

## **AUTHORITY**

If the person signing the Agreement (signatory) is doing so as a representative of the Permittee, the signatory hereby acknowledges that he or she is doing so on the Permittee's behalf and represents and warrants that he or she has the authority to legally bind the Permittee to the provisions herein.

## **AUTHORIZATION**

This Agreement authorizes only the project described herein. If the Permittee begins or completes a project different from the project the Agreement authorizes, the Permittee may be subject to civil or criminal prosecution for failing to notify CDFW in accordance with FGC section 1602.

**CONCURRENCE**

The undersigned accepts and agrees to comply with all provisions contained herein.

**FOR Mr. Thaddeus Diaz**

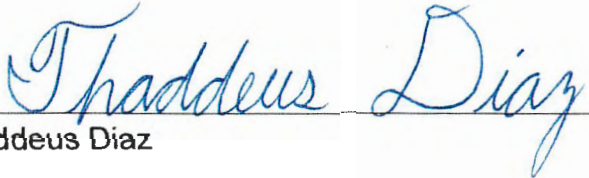
  
\_\_\_\_\_  
Thaddeus Diaz

7-15-16  
\_\_\_\_\_  
Date

**FOR DEPARTMENT OF FISH AND WILDLIFE**

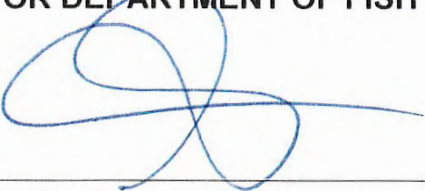
  
\_\_\_\_\_  
Gordon Leppig  
Senior Environmental Scientist Supervisor

7/19/16  
\_\_\_\_\_  
Date

Prepared by: David Manthorne, Environmental Scientist, March 10, 2016