



P.O. Box 733, Hydesville, CA 95547 . (707) 768-3743 . (707) 768-3747 fax

Integrated Horticulture Systems LLC  
PO Box 2344  
Redway CA 95560



**Integrated Horticulture Systems LLC Less Than Three Acre Conversion Mitigation Plan**

This document has been prepared pursuant to Section 55.4.10(j) of the Humboldt County Commercial Medical Marijuana Land Use Ordinance, applications for Commercial Cannabis Activity occupying sites created through prior unauthorized conversion of timberland. The document evaluates site conditions and conversion history for the parcel and contains a Registered Professional Foresters (RPF’s) recommendation as to remedial actions necessary to bring the conversion area into compliance with provisions of the Forest Practice Act.

1. Contact Information

a. Timberland/Timber Owner of Record:

Integrated Horticulture Systems LLC  
PO Box 2344  
Redway CA 95560

b. Registered Professional Forester Preparing Report:

Stephen Hohman, RPF #2652  
PO Box 733  
Hydesville CA 95547  
(707) 768-3743

2. Location of Project

a. Site Address: 8200 Salmon Creek Road Miranda, CA

b. Community Area: Miranda

c. Assessor’s Parcel No(s): 221-011-021

d. Parcel Size(s): 80 Ac.

3. Project Description

a. Timber stand characteristics including species composition and age class.

The Integrated Horticulture Systems LLC property is within a matrix of mixed Douglas fir, Oregon white oak, California bay, incense cedar forest and grassland. Tree species present consists primarily of even-age second growth Douglas-fir, white oak, bay and cedar. The property is zoned Timber Production (TPZ) and Agriculture Exclusive (AE).

b. Watercourse and Lake Protection Zones (WLPZ) which exist within the boundaries of the parcel or immediate vicinity of the project (Section 916.4)

The property does contain watercourses that require WLPZ or ELZ protection. As per the Forest Practice Rules, the riparian buffers requirements are listed as follows:

Class II standard watercourse 14CCR 916.9(g): (Class II watercourses within the Coastal Anadromy Zone)

*ZONE WIDTHS:*

*Channel Zone = channel between the WTL.*

*<30% = 15' Core Zone and 50' Inner Zone*

*30%-50% = 15' Core Zone and 75' Inner Zone*

*>50% = 15' Core Zone and 100' Inner Zone*

Class III watercourse 14CCR 916.9(h): (Class III watercourses within a coastal anadromy zone)

*ELZ WIDTHS:*

*30 ft. for side slopes <30%.*

*50 ft. for side slopes >30%.*

c. Describe the timber harvest history, including timber operations within the parcel prior to the unauthorized conversion.

The area has no previous entries with CALFIRE.

d. Identify and describe any portions of the parcel that are part of the unauthorized conversion of timberland. Calculate the total acreage of all areas converted. Differentiate between discrete (non-contiguous) areas of conversion and provide relevant sub-totals of these acreages.

There are four sites, totaling 1.53 acres of converted land on the property.

Site	Year Converted	Acres
1	Before 2005	0.18
2	2010-2012	1.05
3	Open grassland since 6/12/1993	0.23
4	Unknown	0.09

#### 4. Analysis of Consistency between Unauthorized Conversion and Applicable Forest Practice Rules.

##### **Site 1 (Building Site)**

History: Review of aerial imagery indicates the site was converted sometime between 1993 and 2005. Imagery from 6/12/1993 shows an active ranch road passing through what is now site 1 with forested areas south of the road. The next available image from 6/11/2005 shows a clearing with a building present south of the road. No significant grading or tree removal has occurred at the site, however several trees appear to have been removed sometime between 1993 and 2005 prior to construction of the building. The site was expanded between 2010 and 2012 by addition of a driveway and small generator shed (24' by 24') north of the road. No trees were removed to expand the conversion area. No timber harvesting has occurred in or around this site in the last ten years. No permit was obtained from CALFIRE to clear the area for such activities. A portion of the site is within the 100' WLPZ of a class II watercourse to the south of the conversion. An on the ground survey was completed on May 5<sup>th</sup>, 2021 confirming the watercourse classification as a non-fish bearing stream. No rare threatened or endangered animals or plants present within 1000' as per 2021 CNDDDB search. No hazard reduction issues present at or near the site. The site is zoned Agriculture Exclusive (AE) and Timber Production Zone (TPZ). Ownership at the time of the illegal conversion is unknown.

Numbers of acres converted without 14CCR1104.1: **0.18**

##### **Site 2 (Cultivation Site)**

History: Review of aerial imagery indicates the site was first converted between 2010 and 2012. Imagery from 4/24/2010 shows open grassland with a ranch road adjacent to what is now site 2. The next available image dated 8/23/2012 shows grading and the installation of two greenhouses. The site was expanded in 2013 or 2014 by additional grading and the installation of three greenhouses. The site was converted from grassland for use as a cannabis cultivation site and has been used as a cultivation site since that time. One tree was cut to convert the area to a cultivation site. No timber harvesting has occurred in or around this site in the last ten years. No permit was obtained from CALFIRE to clear the area for such activities. A portion of the site is within the 50' ELZ of a class III watercourse to the northwest of the conversion. Please see RP 10, 11, and 12 for mitigations. No rare threatened or endangered animals or plants present within 1000' as per 2021 CNDDDB search. No hazard reduction issues present at or near the site. The site is zoned Agriculture Exclusive (AE). Ownership at the time of the illegal conversion was Chester "Chet" Clark.

Numbers of acres converted without 14CCR1104.1: **1.05**

##### **Site 3 (Proposed Cultivation Site)**

History: The site appears as an open grassland in all available imagery back to 1993. No cannabis cultivation has occurred on this site to date. No trees have been or need to be cleared to convert the area to a cultivation site. No timber harvesting has occurred in or around this site in the last ten years. The proposed site will be converted for cannabis cultivation outside of all WLPZ and ELZs. No rare threatened or endangered animals or plants present within 1000' as per 2021 CNDDDB search. A hazard reduction issue is present at this site. Woody debris has been piled in the center of this site from the tree removed at Site 2. The site is zoned Agriculture Exclusive (AE). Ownership at the present time is Integrated Horticulture Systems LLC.

Numbers of acres converted without 14CCR1104.1: **0.23**

#### Site 4 (Water Tank Storage Site)

History: It is unknown when this site was converted. It appears there was no overstory tree removal for the site. During the inspection there were no signs of understory tree removal at the site. The site consists of two 5,000 gallon water tanks on a flat area near the forest edge. It is likely the site was converted between 2010 and 2012 coinciding with other activity on the property. No timber harvesting has occurred in or around this site in the last ten years. No permit was obtained from CALFIRE to clear the area for such activities. The conversion area is outside of all WLPZ and ELZs. No rare threatened or endangered animals or plants present within 1000' as per 2020 CNDDDB search. No hazard reduction issues present. The site is zoned Timber Production Zone (TPZ). Ownership at the time of the illegal conversion is unknown.

Numbers of acres converted without 14CCR1104.1: **0.09**

**Mitigations for Project:** Road Points (RP) are specific locations that are currently in conflict with the Forest Practice Rules or have potential to cause environmental damage. Road points have been identified from where the access road enters the property to in and around the conversion sites.

**RP1** Existing and functional 36" diameter culvert on a Class II watercourse. Install a critical dip northwest of the crossing centerline. Rock the dip with 4" - 6" diameter sharp angular rock.

**RP2** Maintain and enhance road segment to divert surface drainage. Outslope road segment west towards the drainage ditch. Rock with 1" to 2" diameter crush rock to reduce sediment transport from road prism.

**RP3** Divert surface drainage. Install a rocked rolling dip to direct drainage southwest, towards the drainage ditch. Line/cap the dip with 2" to 4" diameter crush rock to reduce sediment transport from road prism.

**RP4** Divert surface drainage. Install a rocked rolling dip to direct drainage west. Line/cap the dip with 2" to 4" diameter crush rock to reduce sediment transport from road prism.

**RP5** Existing undersized 8" diameter culvert on the headwaters of a Class III watercourse. Install an oversized 18" diameter culvert to stream grade. Rock the culvert inlet and outlet with 1' to 2' diameter sharp angular rock. Install a critical dip on the centerline. Rock the dip with 4" to 6" diameter sharp angular rock. **1600 required.**

**RP6** Existing and functional 18" diameter ditch relief culvert (DRC). Clean and maintain the inlet and outlet. If DRC fails, install oversized 24" diameter DRC.

**RP7** Existing and functional, but undersized, 54" diameter culvert with shot gunned outlet on a Class II watercourse. Install a 66" diameter culvert to stream grade. Rock the culvert inlet and outlet with 2' to 4' diameter sharp angular rock. Install additional 2' to 4' diameter sharp angular rock at base of the outlet. Rock the inside ditch for 30' north of the hingeline with 2" to 4" diameter crush rock. **1600 required.**

**RP8** Existing and failing 18" diameter DRC. Remove 18" DRC, install a rocked rolling dip or a 24" diameter DRC draining towards the Class II watercourse. For installing a rocked rolling dip, line/cap the dip with 2" to 4" diameter crush rock to reduce sediment transport from road prism. For installing a 24" diameter DRC, rock the inlet and outlet with 2' to 4' diameter sharp angular rock.

**RP9** Existing and functional 18" diameter DRC. Clean and maintain the inlet and outlet.



**RP10** Two greenhouses present at Site 2 within 30' of a Class III watercourse. Pull back the cultivation infrastructure outside of the 50' ELZ riparian buffer, including all grow soil. Seed and mulch all exposed native soil within the buffer once removal of cultivation infrastructure and grow soil is complete.

**RP11** Exposed 2' by 4' grow soil pile at Site 2 within a Class III watercourse riparian buffer. Remove grow soil from the 50' ELZ riparian buffer zone. Seed and mulch all exposed native soil within the buffer once removal of grow soil is complete.

**RP12** Three greenhouses present at Site 2 within 35' of a Class III watercourse. Pull back the cultivation infrastructure outside of the 50' ELZ riparian buffer, including all grow soil. Seed and mulch all exposed native soil within the buffer once removal of cultivation infrastructure and grow soil is complete.

**RP13** Existing and functional 12" diameter DRC. Clean and maintain the inlet and outlet.

**RP14** Existing and functional oversized 24" diameter culvert on a Class III watercourse. Clean and maintain the inlet and outlet. Install additional 2' to 4' diameter sharp angular rock at base of the outlet. **1600 required.**

## 5. Photos, Maps, and Figures

### Site 1 (Building Site)

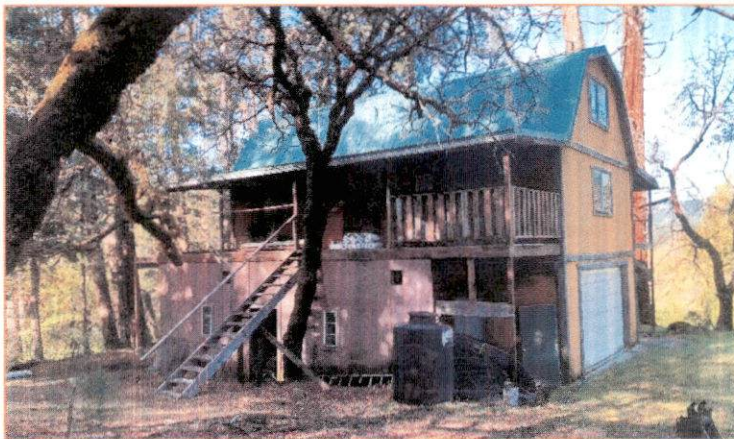

1A) Position east facing west.

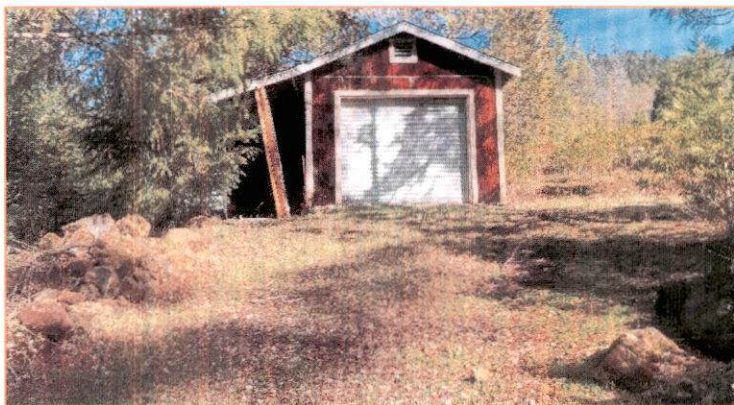

1B) View of small shed from access road, south facing north.



Site 2 (Cultivation Site)

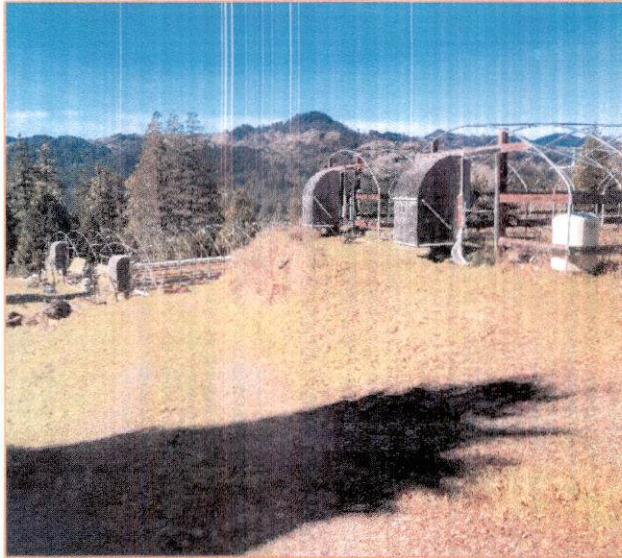

2A) Northeast corner facing southwest.

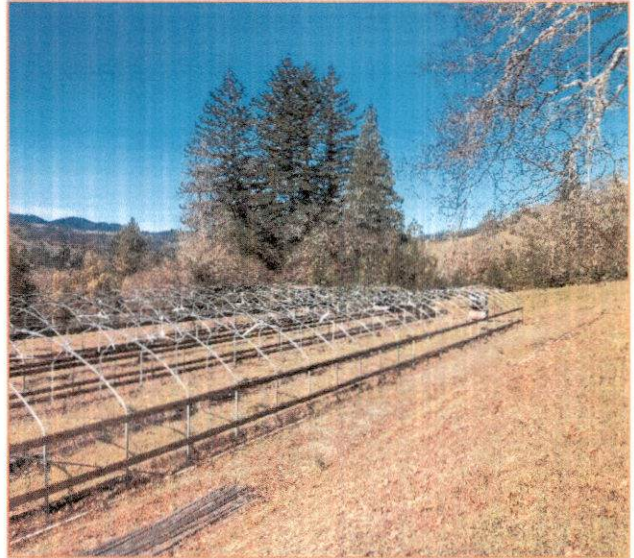

2B) Northeast corner facing west.

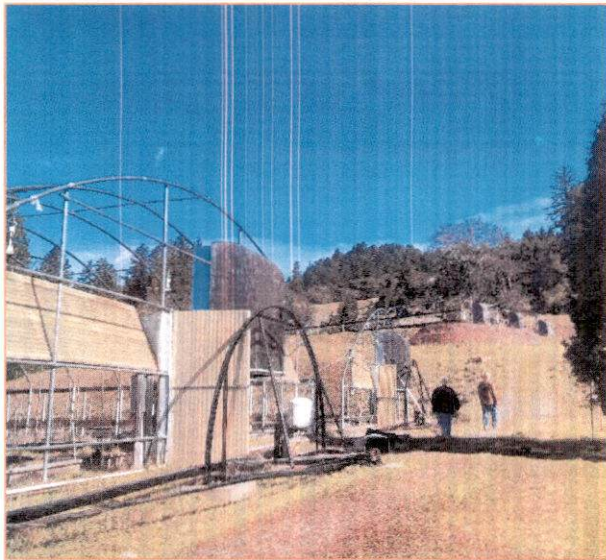

2C) Southeast corner facing north.

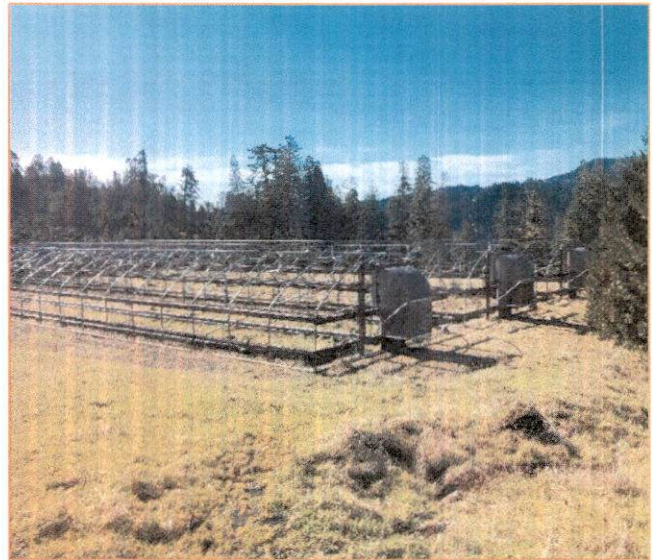

2D) Northwest corner facing southeast.



Site 3 (Proposed Cultivation Site)



3A) West facing east, note flagging of 50' ELZ buffer.



3B) South facing north.

**Site 4 (Water Tank Storage Site)**

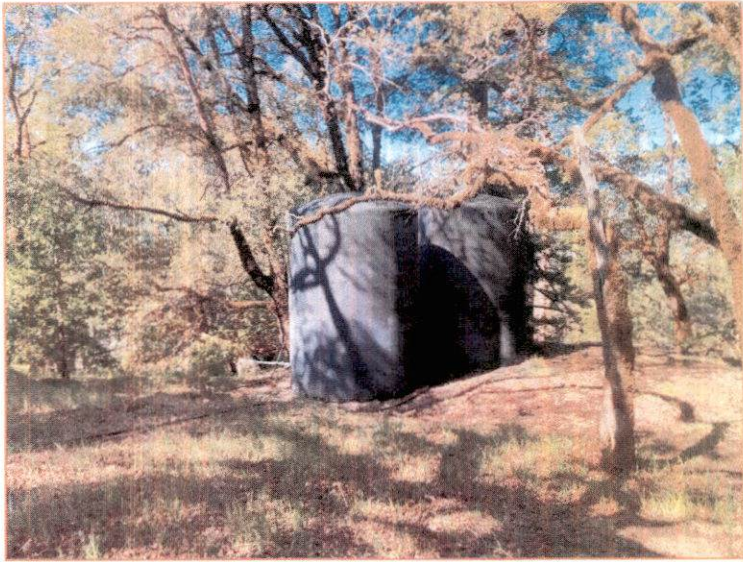

4B) Northeast facing southwest.

**Mitigations for Project (Road Points)**



RP1) Install a critical dip.



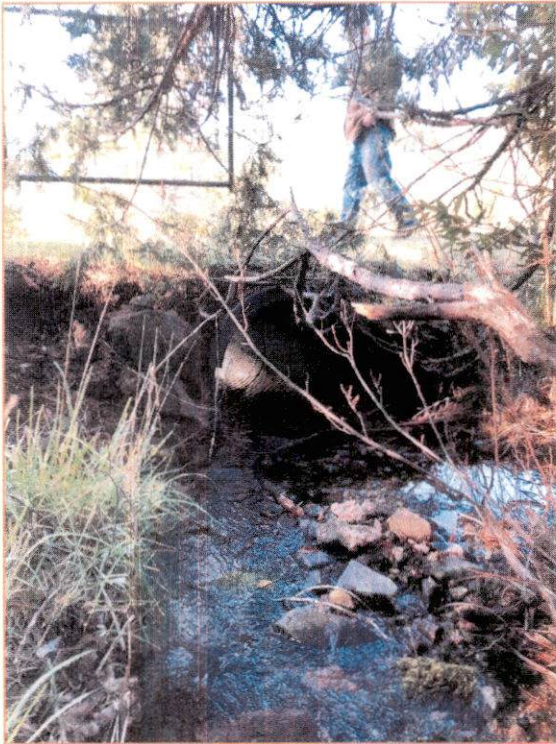

RP1) View of inlet on a Class II stream.

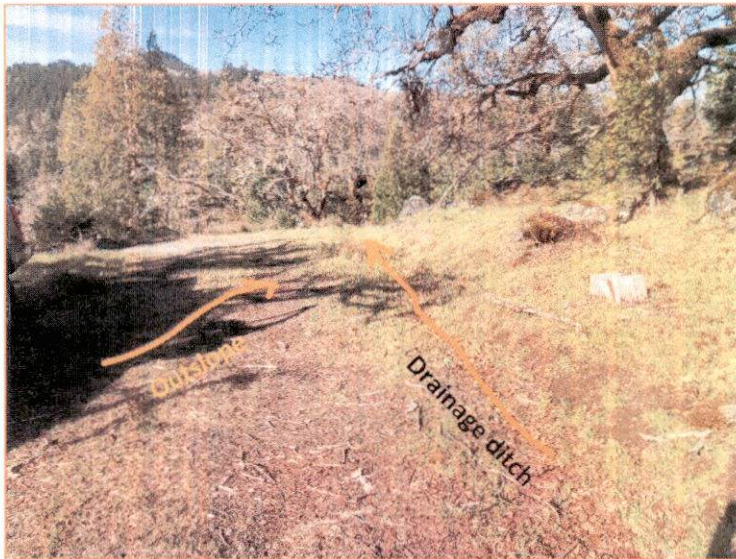

RP2) Outslope road segment towards drainage ditch.

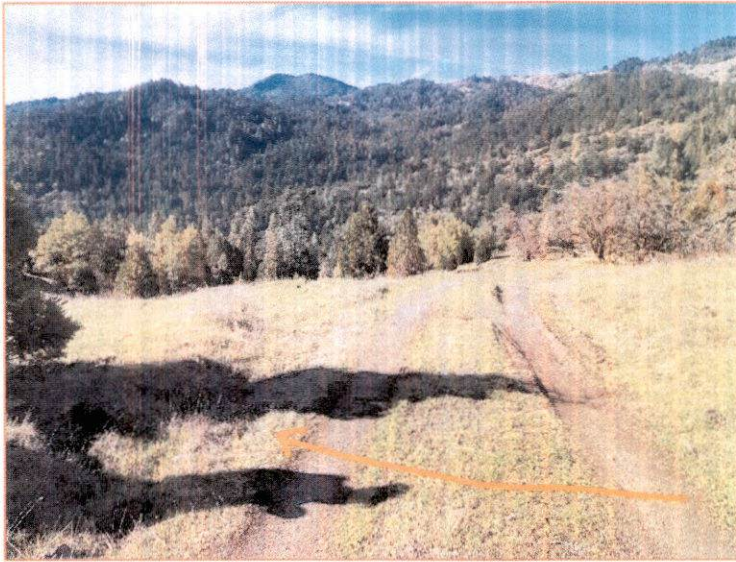

RP3) Install rocked rolling dip.

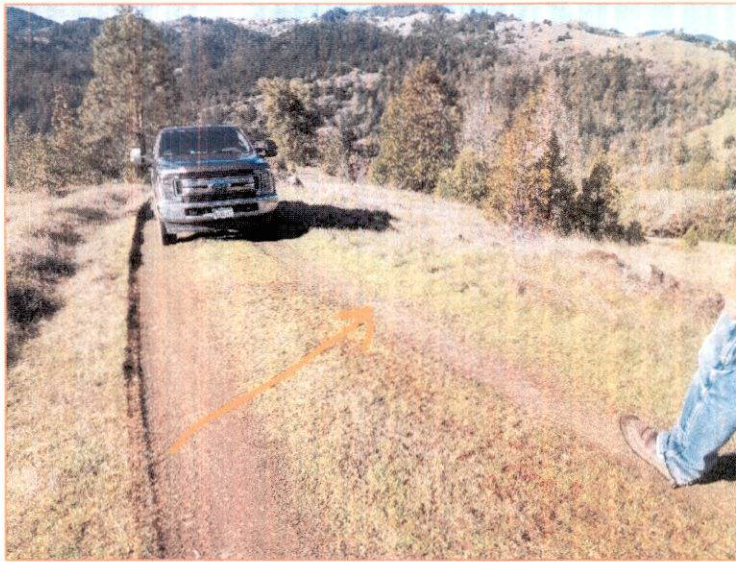

RP4) Install rocked rolling dip.





RP5) Viewing upstream at the inlet, headwaters of a class III stream.

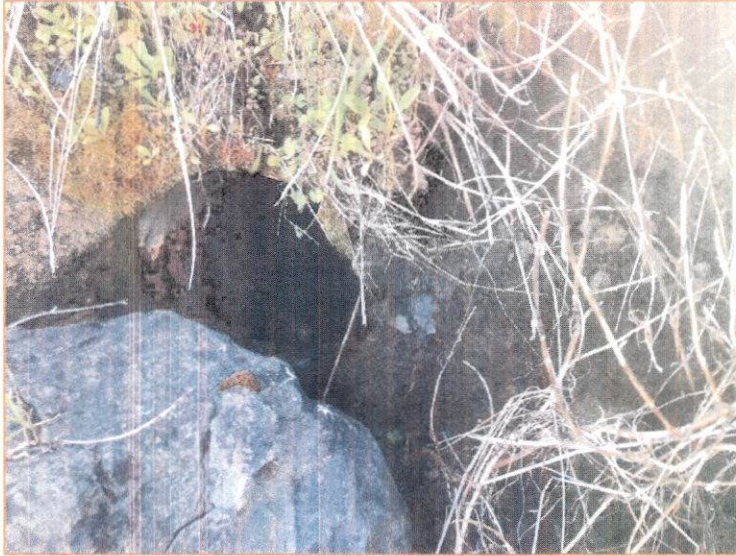

RP5) View of outlet, replace undersized culvert on a class III stream.





RP6) View of outlet, existing and functional DRC.



RP7) View of inlet on a class II stream.



RP7) View of shotgunned outlet on a class II stream.



RP8) Install rocked rolling dip or replace failing DRC.





RP9) Clean and maintain DRC inlet.



RP9) Clean and maintain DRC outlet.



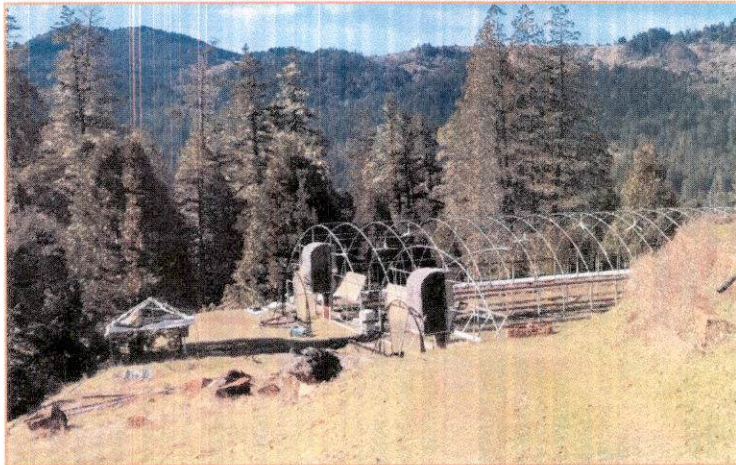

RP10) Remove greenhouse infrastructure within a class III stream buffer, no photos of buffer setback available.

RP11) Remove soil pile within a class III stream buffer, no photos available.

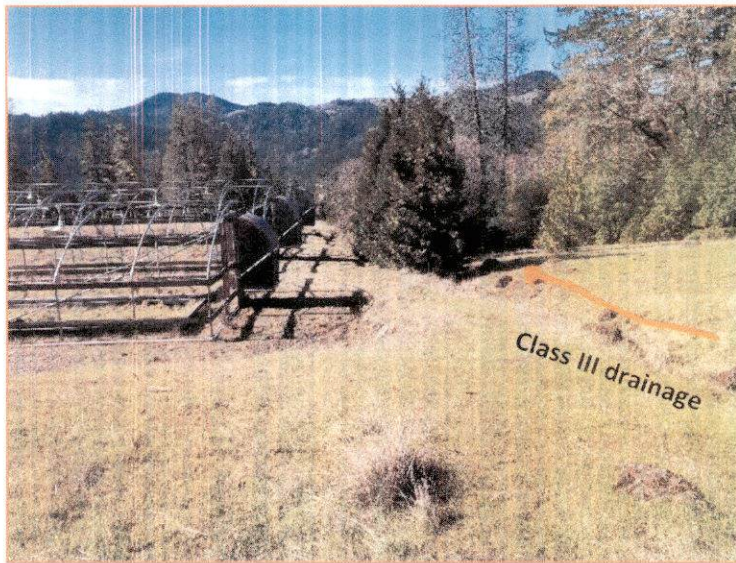

RP12) Remove greenhouse infrastructure within a class III stream buffer.

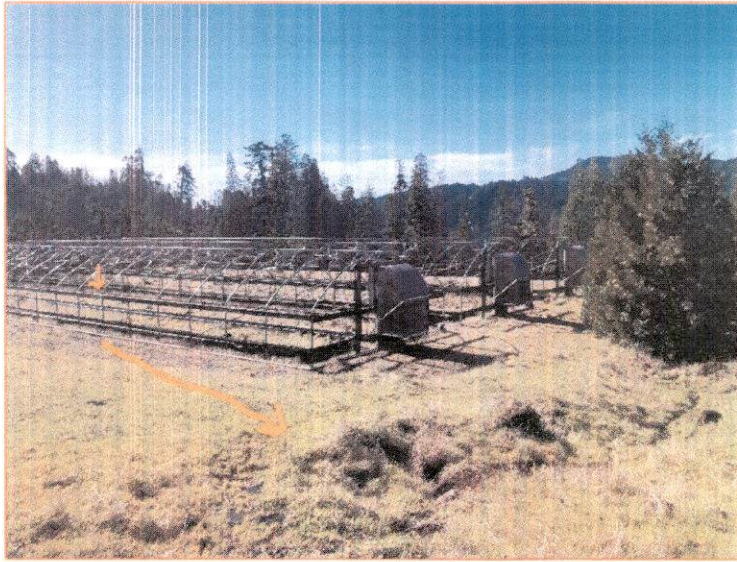

RP12) View of greenhouses from class III stream, note arrows display 50' riparian buffer setback.



RP13) Clean and maintain DRC inlet.





RP14) Clean and maintain the inlet.

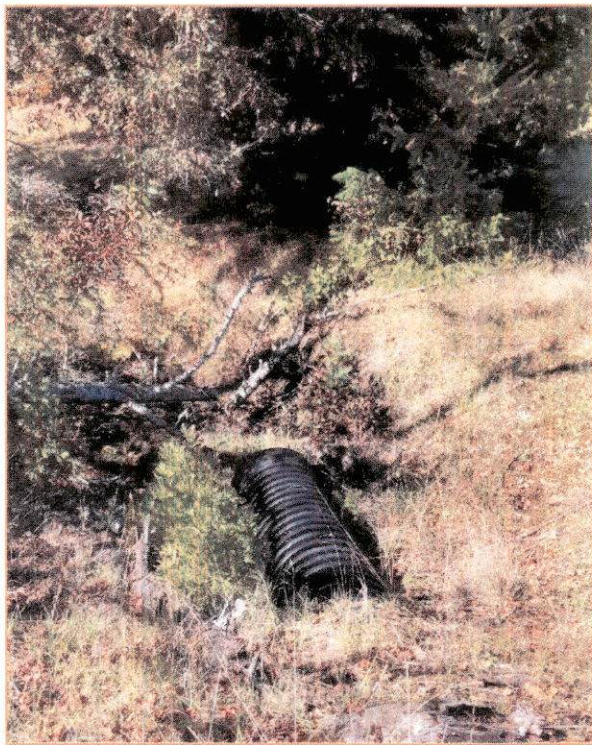

RP14) View of outlet, install additional rock at base of outlet.



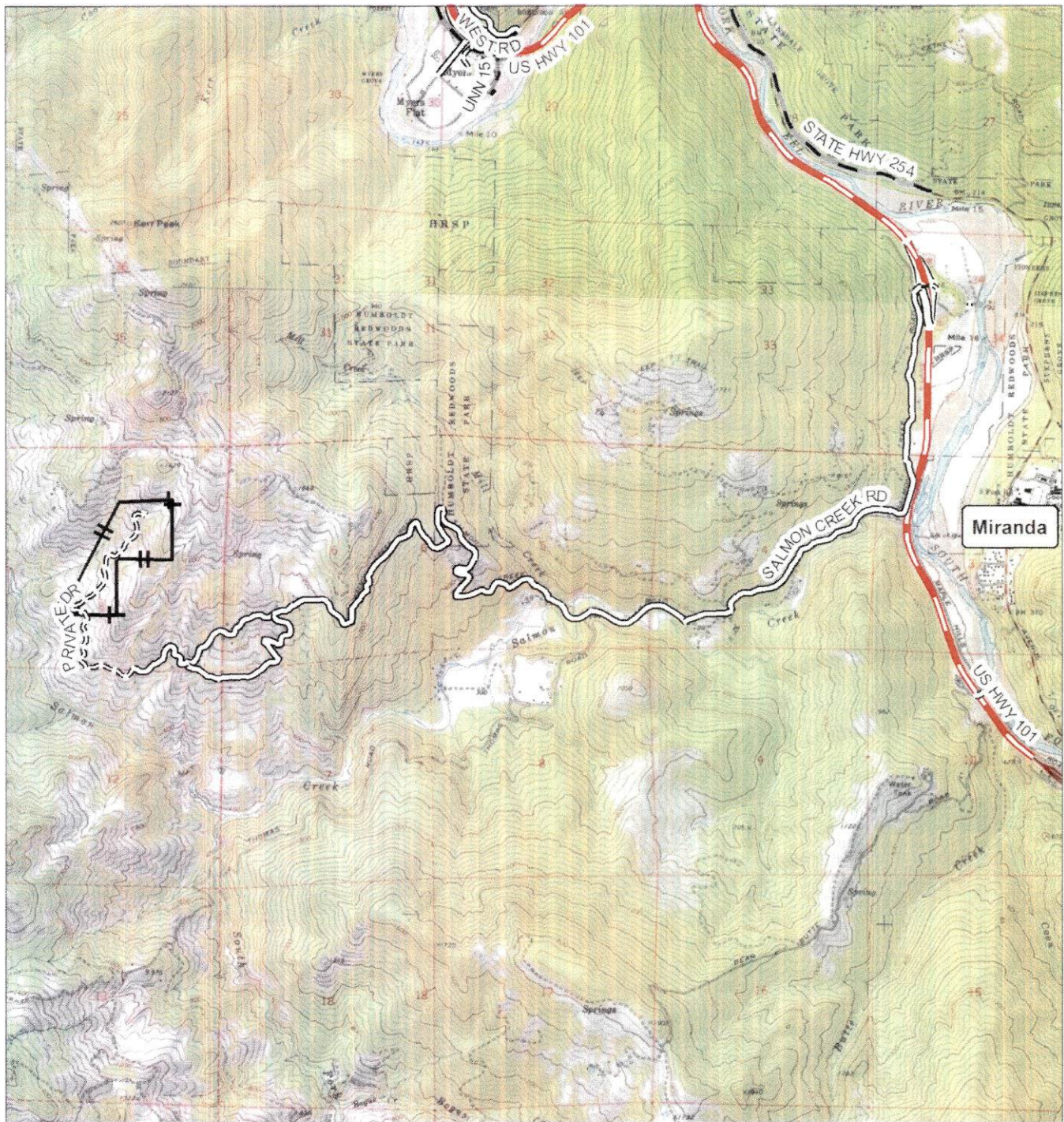

**Integrated Horticulture Systems  
General Location Map**

**APN: 221-011-021**

Section 1; T3S; R2E; HB&M; Humboldt  
County  
Located on the Ettersburg 7.5' USGS  
Quadrangle

- ==== Local Roads
- Unclassified
- ==== Major Collectors
- ==== Minor Collectors
- ==== HWY 101
- ===== Private
- Property Boundary



0 1,600 3,200 6,400 Contour Interval: 40'  
Feet 1 inch = 3,500 feet

Hohman And Associates Forestry Consultants  
Date: 4/9/2021



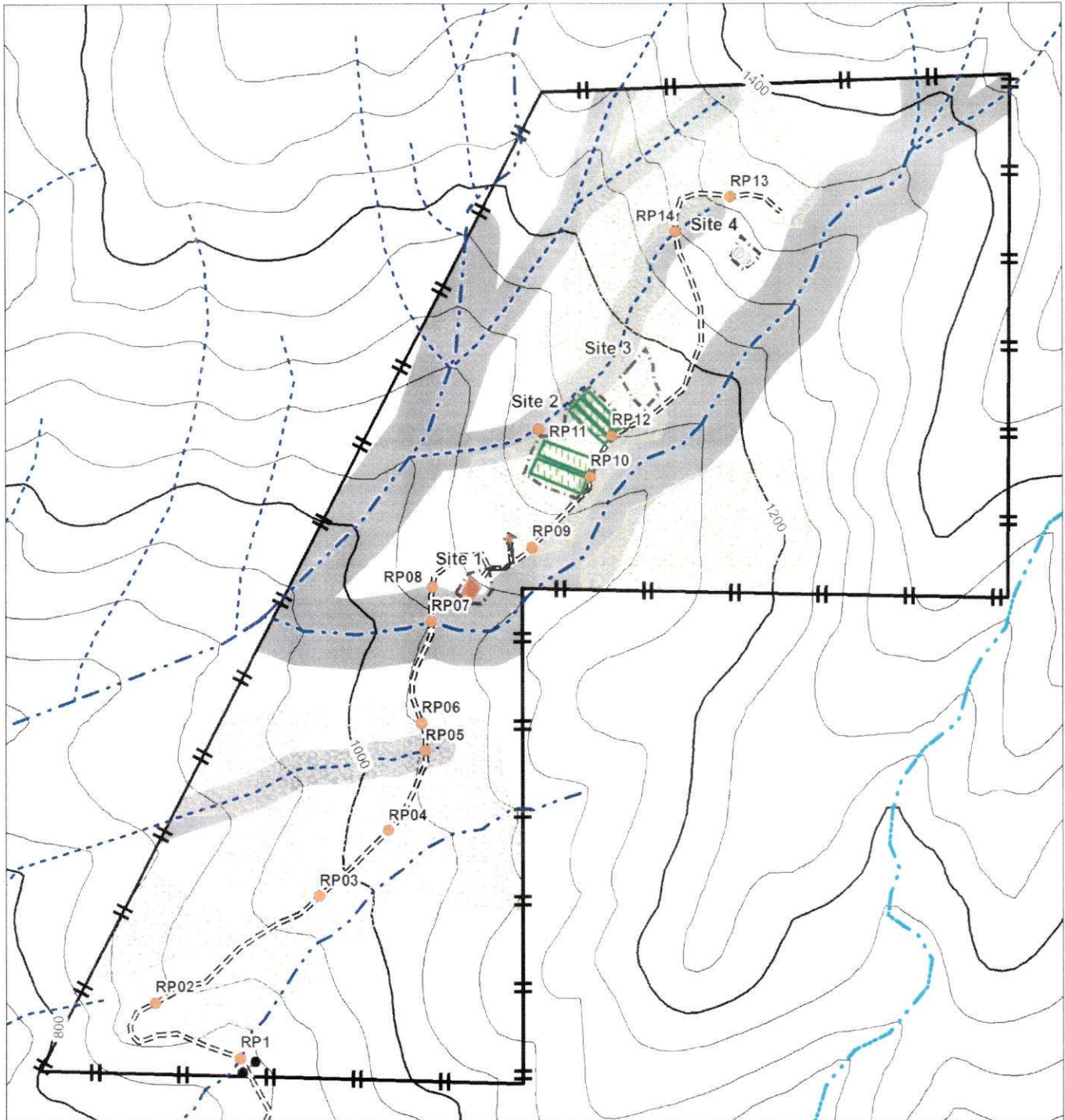

**Integrated Horticulture Systems  
Detailed Overview Map**

**APN: 221-011-021**

Section 1; T3S; R2E; HB&M; Humboldt  
County  
Located on the Ettersburg 7.5' USGS  
Quadrangle

- Roadpoints
- Watertank
- Gate
- Class I Stream
- - - Class II Stream
- - - - - Class III Stream
- - - - - Unclassified Class II or III
- Stream Management Area
- Structures
- Greenhouses
- Conversion Sites
- Non-Stocked Area
- - - - - Permanent Rocked Road
- Property Boundary



Hohman And Associates Forestry Consultants  
Date: 5/17/2021

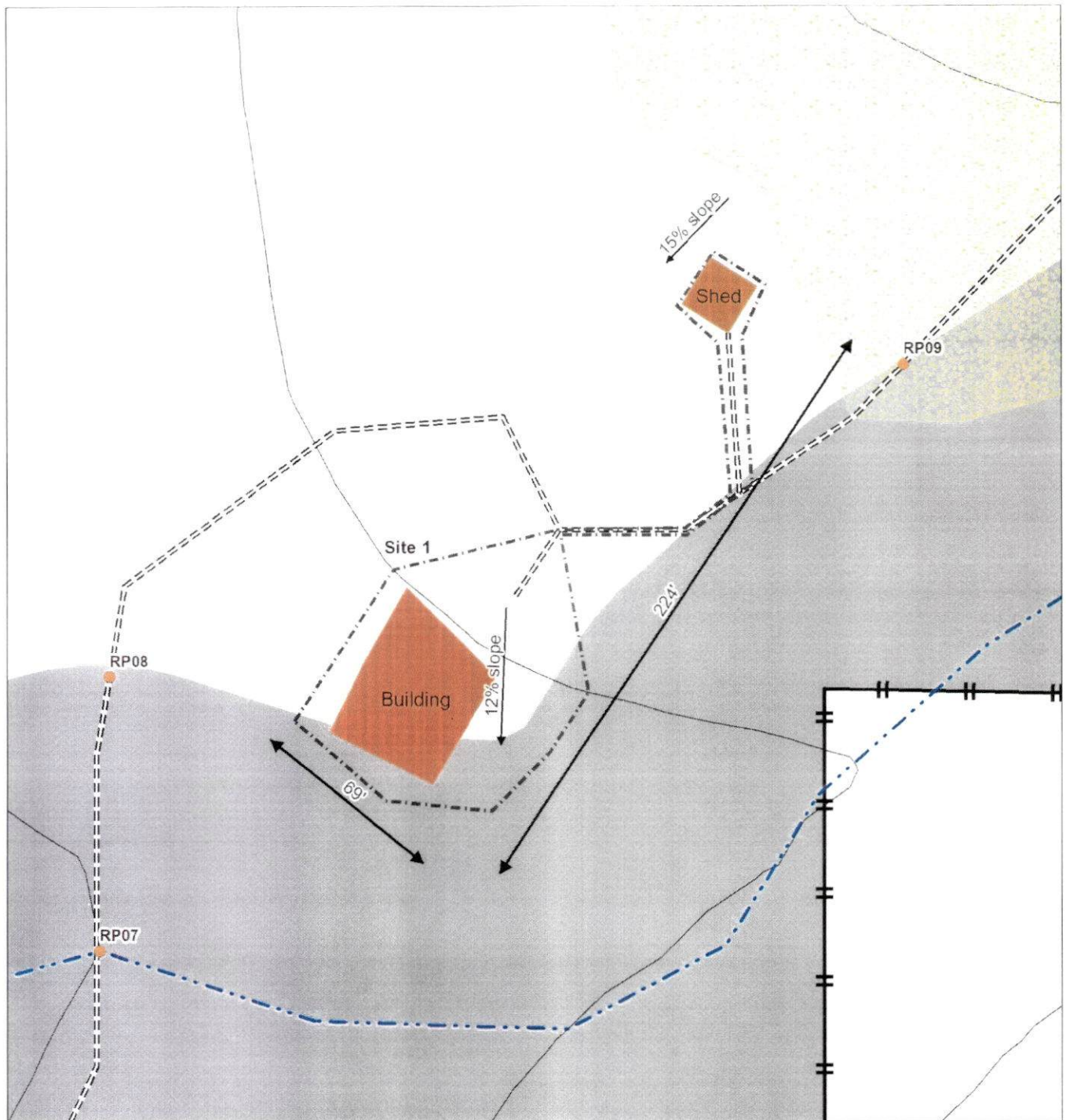

<p><b>Integrated Horticulture Systems Detailed Site 1 Map</b></p> <p><b>APN: 221-011-021</b></p> <p><i>Section 1, T3S, R2E, HB&amp;M; Humboldt County Located on the Ettersburg 7.5' USGS Quadrangle</i></p>	<ul style="list-style-type: none"> <li><span style="color: orange;">●</span> Roadpoints</li> <li><span style="color: blue;">- - - -</span> Class II Stream</li> <li><span style="background-color: gray; border: 1px solid black; display: inline-block; width: 15px; height: 10px;"></span> Stream Management Area</li> <li><span style="background-color: orange; border: 1px solid black; display: inline-block; width: 15px; height: 10px;"></span> Structures</li> <li><span style="border: 2px dashed black; display: inline-block; width: 15px; height: 10px;"></span> Conversion Sites</li> <li><span style="background-color: lightgray; border: 1px solid black; display: inline-block; width: 15px; height: 10px;"></span> Non-Stocked Area</li> </ul>	<ul style="list-style-type: none"> <li><span style="border-bottom: 2px dashed black; width: 20px; display: inline-block;"></span> Permanent Rocked Road</li> <li><span style="border: 1px solid black; width: 15px; height: 10px; display: inline-block;"></span> Property Boundary</li> </ul>	
<p>0 20 40 80 Feet</p>	<p>Contour Interval: 40' 1 inch = 50 feet</p>	<p><i>Hohman And Associates Forestry Consultants</i> Date: 5/17/2021</p>	



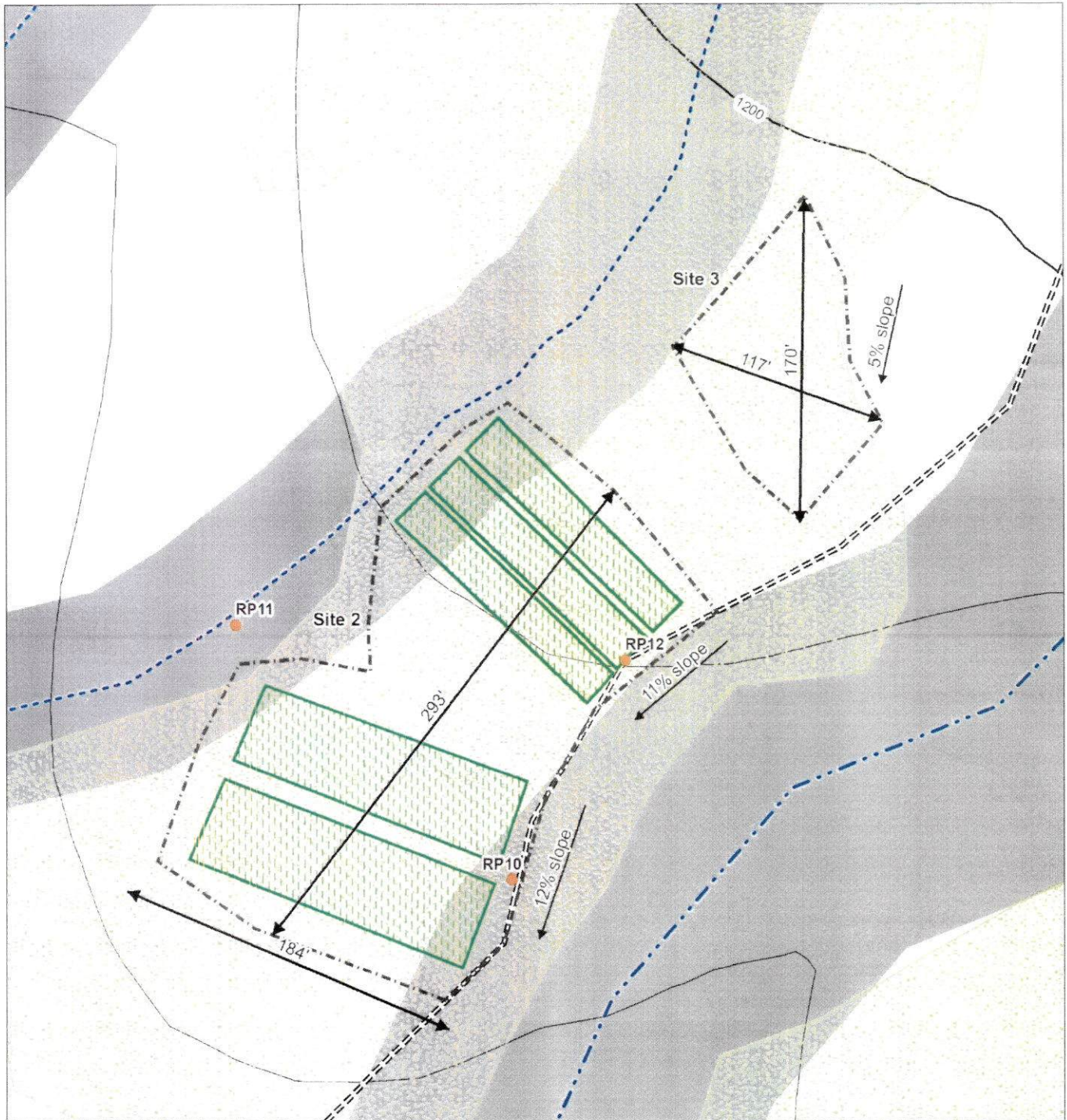

**Integrated Horticulture Systems  
Detailed Site 2 & 3 Map**

**APN: 221-011-021**

Section 1; T3S; R2E; HB&M; Humboldt  
County  
Located on the Ettersburg 7.5' USGS  
Quadrangle

- Roadpoints
- Class II Stream
- - - Class III Stream
- Stream Management Area
- ▨ Greenhouses
- - - Conversion Sites

- Non-Stocked Area
- ==== Permanent Rocked Road
- ▭ Property Boundary

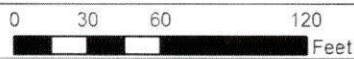

Contour Interval: 40'  
1 inch = 75 feet

Hohman And Associates Forestry Consultants  
Date: 5/17/2021



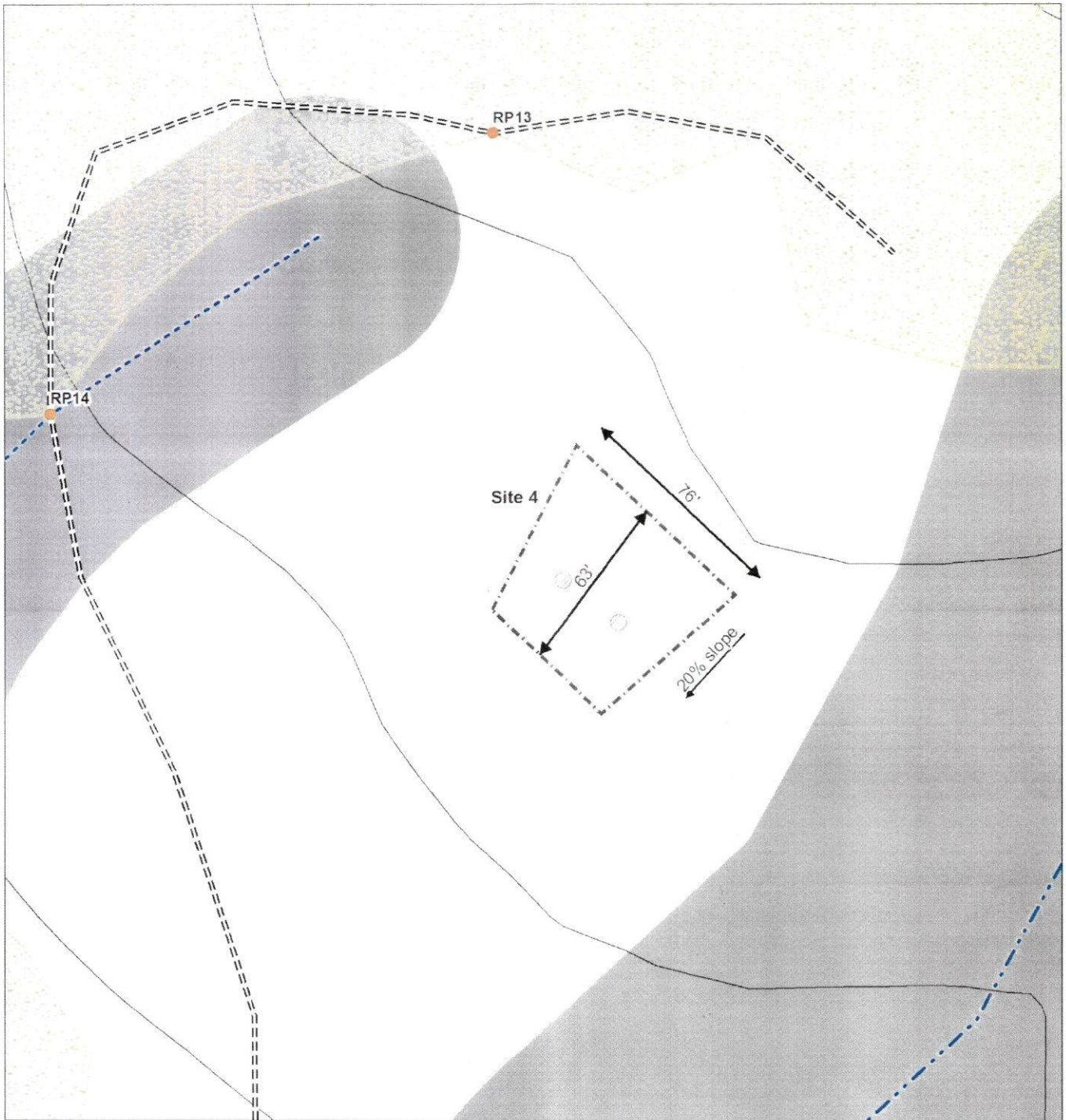

<p><b>Integrated Horticulture Systems Detailed Site 4 Map</b></p> <p><b>APN: 221-011-021</b></p> <p><i>Section 1, T3S; R2E; HB&amp;M; Humboldt County Located on the Ettersburg 7.5' USGS Quadrangle</i></p>	<ul style="list-style-type: none"> <li><span style="color: orange;">●</span> Roadpoints</li> <li><span style="border: 1px solid gray; border-radius: 50%; width: 10px; height: 10px; display: inline-block;"></span> Watertank</li> <li><span style="color: blue; font-weight: bold;">- · - · -</span> Class II Stream</li> <li><span style="color: blue; font-weight: bold;">- - - - -</span> Class III Stream</li> <li><span style="background-color: gray; width: 20px; height: 10px; display: inline-block;"></span> Stream Management Area</li> <li><span style="border: 2px dashed black; width: 20px; height: 10px; display: inline-block;"></span> Conversion Sites</li> </ul>	<ul style="list-style-type: none"> <li><span style="background-color: yellow; width: 20px; height: 10px; display: inline-block;"></span> Non-Stocked Area</li> <li><span style="border-bottom: 2px dashed black; width: 20px; display: inline-block;"></span> Permanent Rocked Road</li> <li><span style="border: 1px solid black; width: 20px; height: 10px; display: inline-block;"></span> Property Boundary</li> </ul>	
<p>0 20 40 80 Feet</p>	<p>Contour Interval: 40' 1 inch = 50 feet</p>	<p><i>Hohman And Associates Forestry Consultants</i> Date: 5/17/2021</p>	



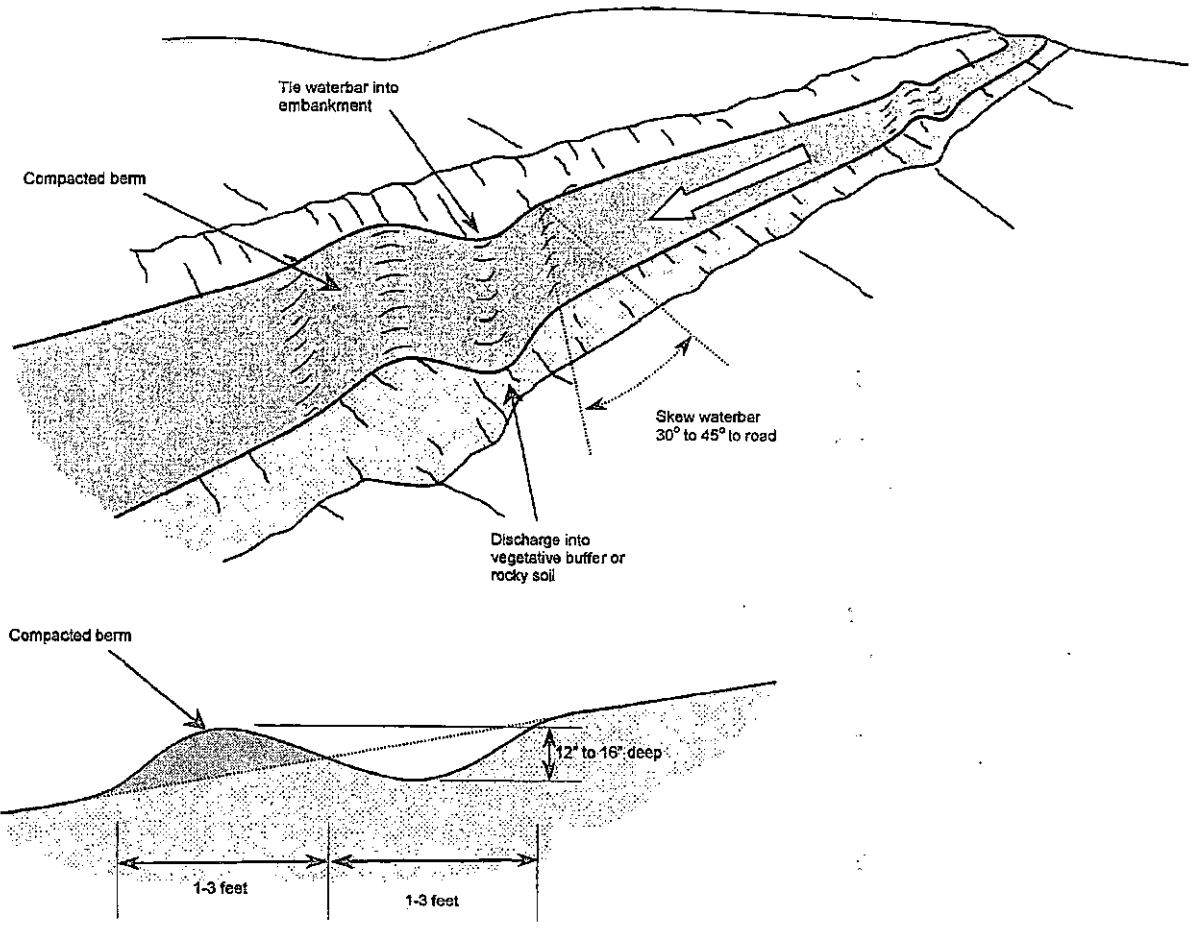

**NOTES**

1. Identify waterbar locations that take advantage of natural drainage features and minimize the amount of disturbance required for waterbar construction
2. All waterbars shall begin at the intersection of the roadbed surface and the cut slope and run the entire width of the road surface prism.
3. Waterbar length shall not exceed 1.5 times the width of the road surface.
4. Acceptable waterbars shall be skewed 30 to 45 degrees.
5. All waterbars shall have free flowing outlets with minimum 2% grade in the bottom of the channel that discharge onto vegetative surfaces or less erodible material where possible.
6. Native materials used to construct downslope berm shall be compacted with equipment to minimize wear resulting from trespass and/or administrative use.
7. Waterbar depth measured from the bottom of the waterbar channel to the top of the compacted berm must be between 12" and 16" high.
8. Compacted waterbars must be passable in a 4WD vehicle unless otherwise specified in the contract or by a logging supervisor in writing.

**WATERBAR  
STANDARD PLAN**

Standard Detail

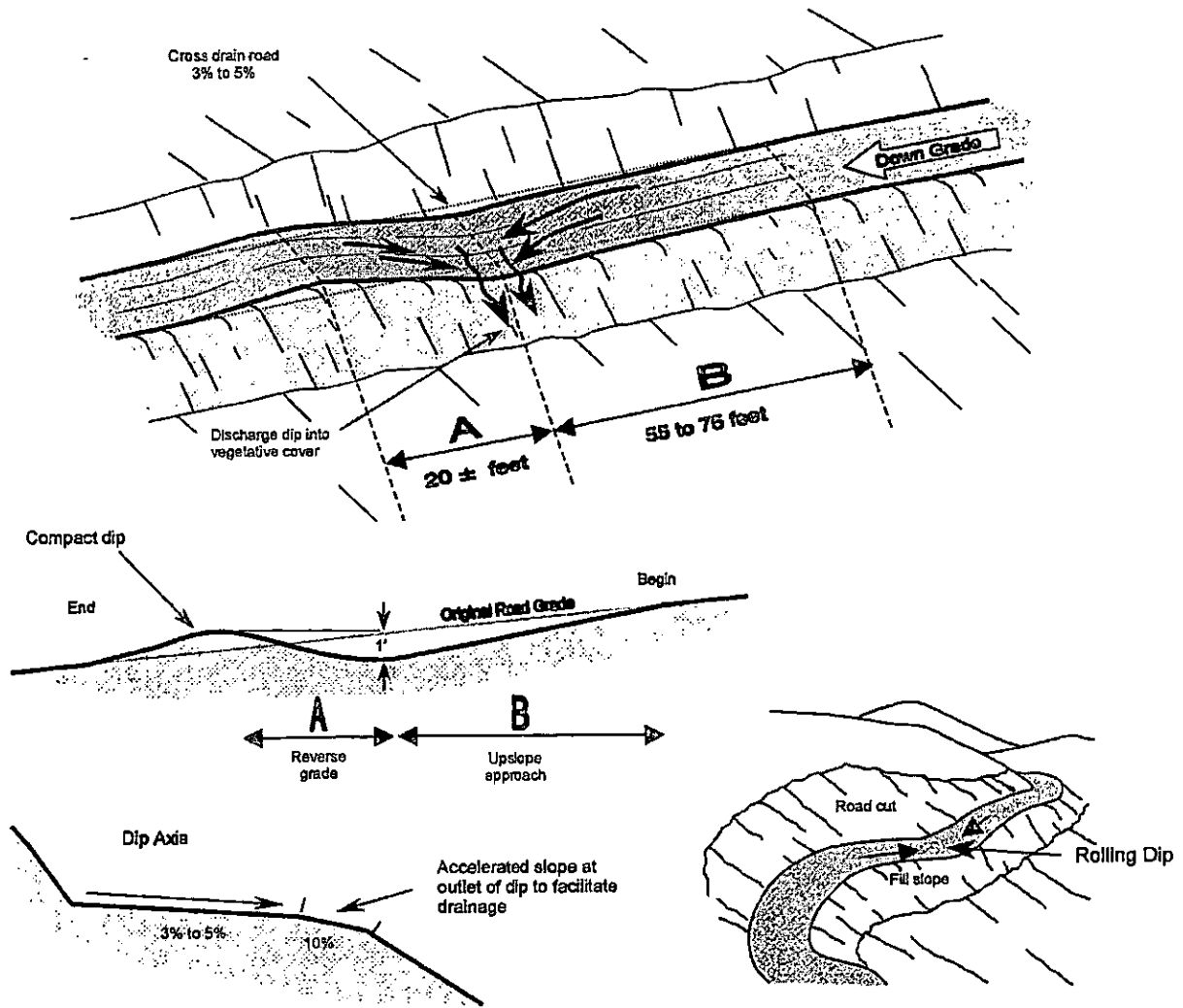

ROLLING DIP DIMENSIONS					
		MAIN LINE ROAD		SECONDARY ROAD	
Road Grade (%)	Depth of trough Depth below downslope crest (ft)	A: Reverse grade (Distance from trough to downroad crest (ft))	B: Upslope Approach (Distance from up-road start of rolling dip to trough (ft))	A: Reverse grade (Distance from trough to downroad crest (ft))	B: Upslope Approach (Distance from up-road start of rolling dip to trough (ft))
<6	1.0	20	65	15	55
6 - 8	1.0	20	75	15	65

**NOTES:**

- A rolling dip is a broad long permanent dip constructed into native soils. It is intended to drain the road while not significantly impeding traffic.
- The cross drain road (outslope) at 3% to 5%
- Dip outlets should be located to drain into areas with adequate sediment filter quality and non-erodible material such as rock, slash, brush, etc. Where specified, the bottom of the outfall of the dip will be surface rocked.
- Where natural slopes exceed 50%, fill shall not be pushed over the dip outlet. A backhoe or excavator may be required to pull back fill at outlet of existing dips.

<p><b>ROLLING DIP STANDARD PLAN</b></p>	<p>Standard Detail</p>
---	------------------------



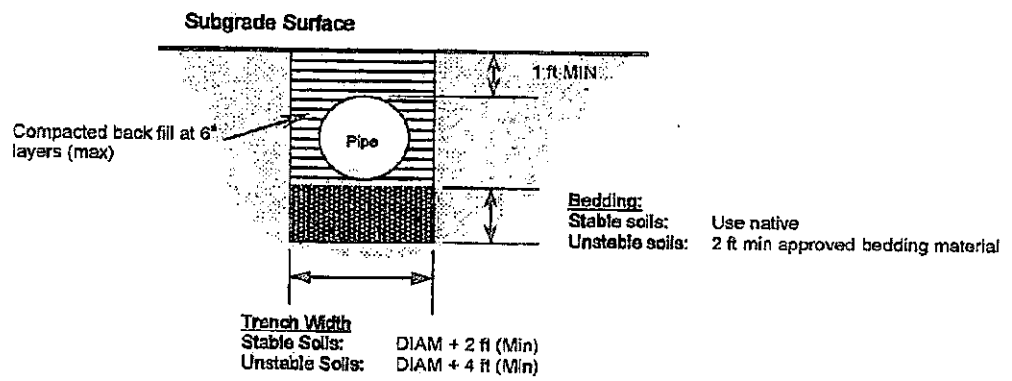
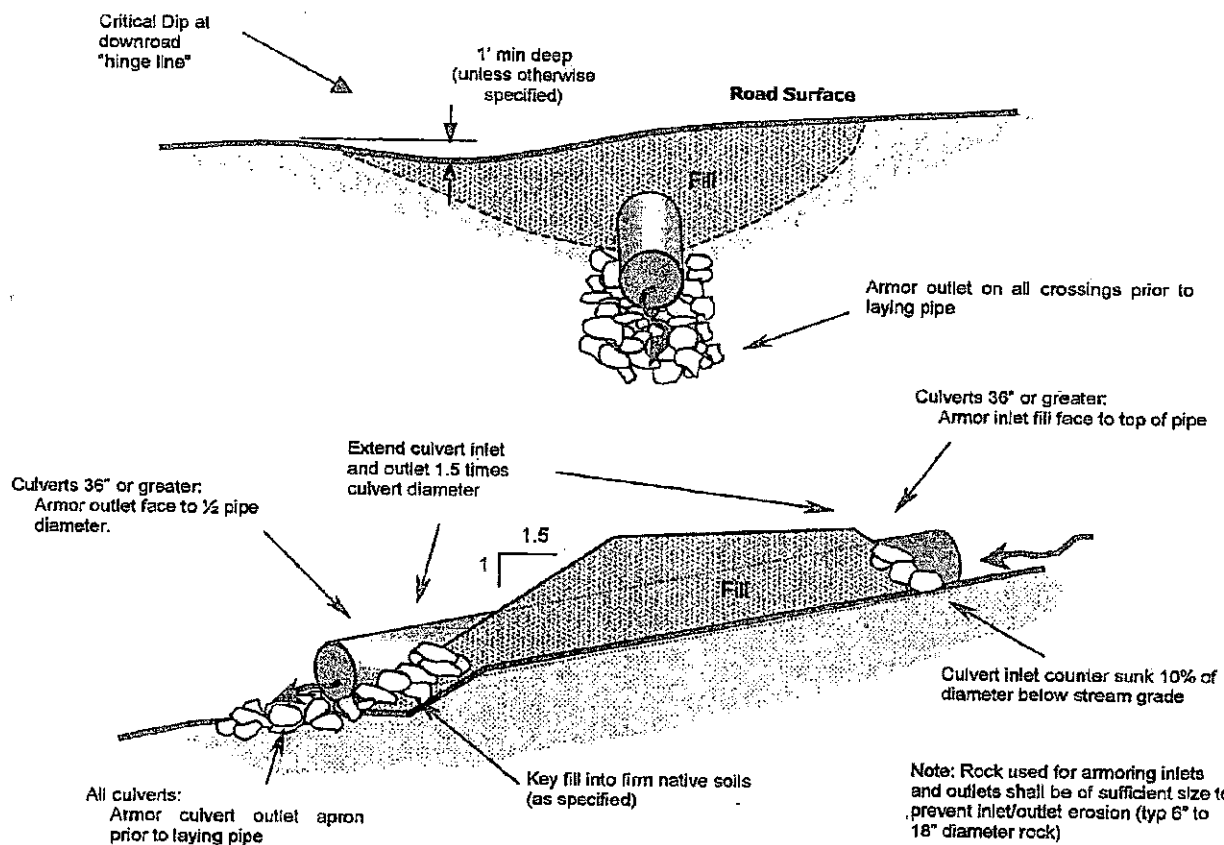

- Notes:**
- The culvert bed shall be clean and free of large woody debris and large rocks.
  - Unsuitable foundation material (highly plastic material - "blue goo") shall be excavated below the invert elevation of the culvert to an approximate depth of 2 feet and a width of at least the culvert diameter plus 4 feet.
  - Unsuitable material shall be replaced with selected granular foundation material and compacted to obtain a uniform foundation.
  - Select mineral soil shall be used for culvert backfill. The back fill shall be free of lumps, chunks, highly plastic material, and organic material
  - No rocks greater than 3" in any dimension placed closer than 1 foot to the culvert.
  - Back fill shall be compacted to a degree greater than the surrounding soils. Soil moisture shall be adequate to achieve suitable compaction
  - See Text for more detail.

**PERMANENT WATERCOURSE  
CROSSING STANDARD PLAN**

Standard Detail

If water is present and diversion of flow around the work site is necessary, then an impoundment will be constructed and gravity flow or pumping flow through a pipe around the work site will be utilized.

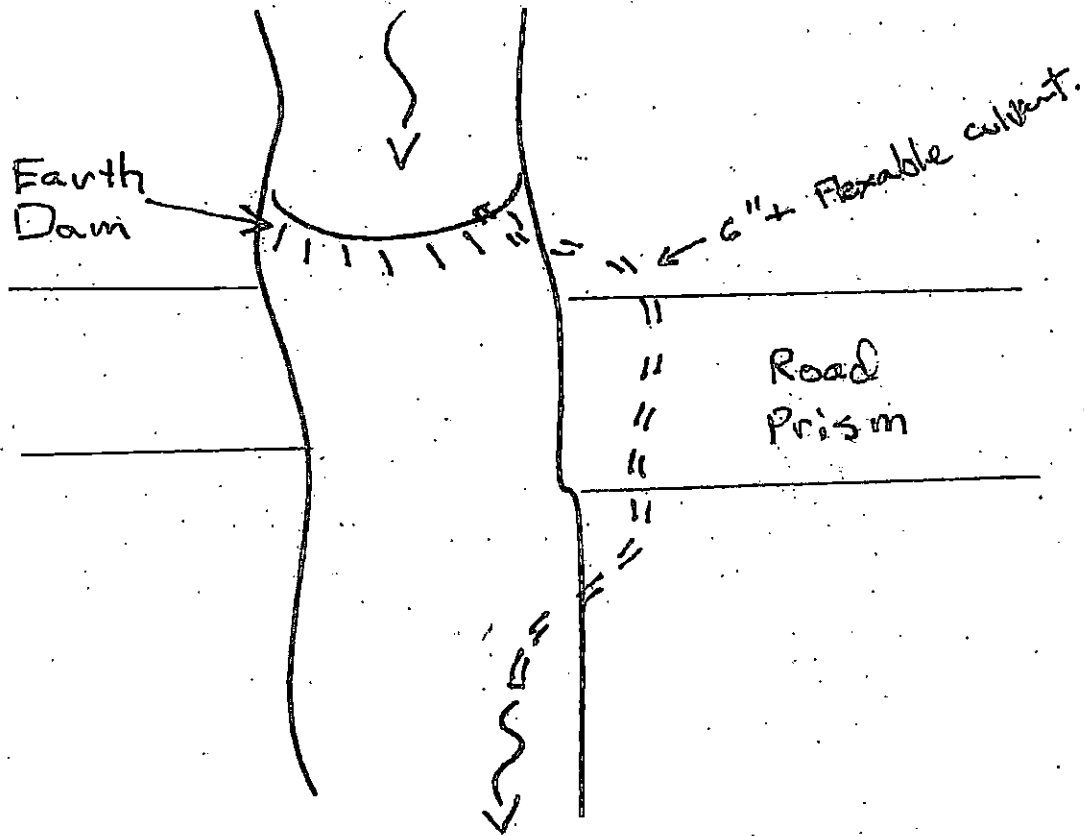



## Determination of 100-Year Flood Flow

Location: Integrated Horticulture Systems Conversion Mitigation

*(Enter data in fields with red-colored headings. Other data fields will be calculated automatically.)*

### Magnitude and Frequency Method for 100-year flood flow (A > 100 acres)

No.	Crossing	Area (acres) A	Basin maximum elevation (ft)*	Crossing elevation (ft)*	Area (mi <sup>2</sup> ) A	Avg. Annual Precipitation (in/yr) P	Elevation Index (mean basin)	100-yr flood flow Q <sub>100</sub> (cfs)			
								North Coast <sup>(1)</sup> (NC)	Sierra <sup>(2)</sup> (S)	North-east <sup>(3)</sup> (NE)	Central Coast <sup>(4)</sup> (CC)
1	RP1	16.23	1115	865	0.025	60	990	19.6	23.7	28.9	29.4
2	RP5	0.47	1060	1045	0.001	60	1052.5	0.9	1.1	2.2	1.5
3	RP7	81.36	1725	1040	0.127	60	1382.5	79.2	89.3	93.8	113.9
4	RP14	0.53	1310	1285	0.001	60	1297.5	1.0	1.1	2.4	1.7
5											
6											

*\*To estimate discharges for bridges, use elevations along watercourse at 85 percent and 10 percent of water-course length from crossing to drainage divide, respectively, instead of using maximum and crossing elevations.*

See below for M&F equations

### Rational Method for 100-year flood flow (A < 200 acres)

No.	Crossing	T <sub>c</sub> = 60((11.9 X L <sup>3</sup> )/H) <sup>0.385</sup>			Q <sub>100</sub> = CIA				100-yr flood flow (cfs) Q <sub>100</sub>	Magnitude & Frequency Q <sub>100</sub> equations
		Channel length (to top of basin) (mi) L	Elevation difference (ft) H	Concentration time (min) T <sub>c</sub>	Runoff coefficient C	100-year Return-Period Precipitation (in/hr) I*	Area (acres) A			
1	RP1	0.25	250	4	0.35	3.32	16.23	18.9	NC (1) Q <sub>100</sub> = 48.5(A) <sup>0.866</sup> (P) <sup>0.656</sup>	
2	RP5	0.01	15	0	0.35	3.32	0.47	0.5	S (2) Q <sub>100</sub> = 20.6(A) <sup>0.914</sup> (P) <sup>1.24</sup> (H) <sup>0.200</sup>	
3	RP7	1.26	685	17	0.35	3.32	81.36	94.5	CC (4) Q <sub>100</sub> = 11.0(A) <sup>0.84</sup> (P) <sup>0.994</sup>	
4	RP14	0.02	25	1	0.35	3.32	0.53	0.6		
5										
6										

*\*Use 100-yr precipitation of duration similar to T<sub>c</sub> or for 10 min, whichever is larger, convert to in/hr for input as "I"*

# Integrated Horticulture Systems Conversion Mitigation

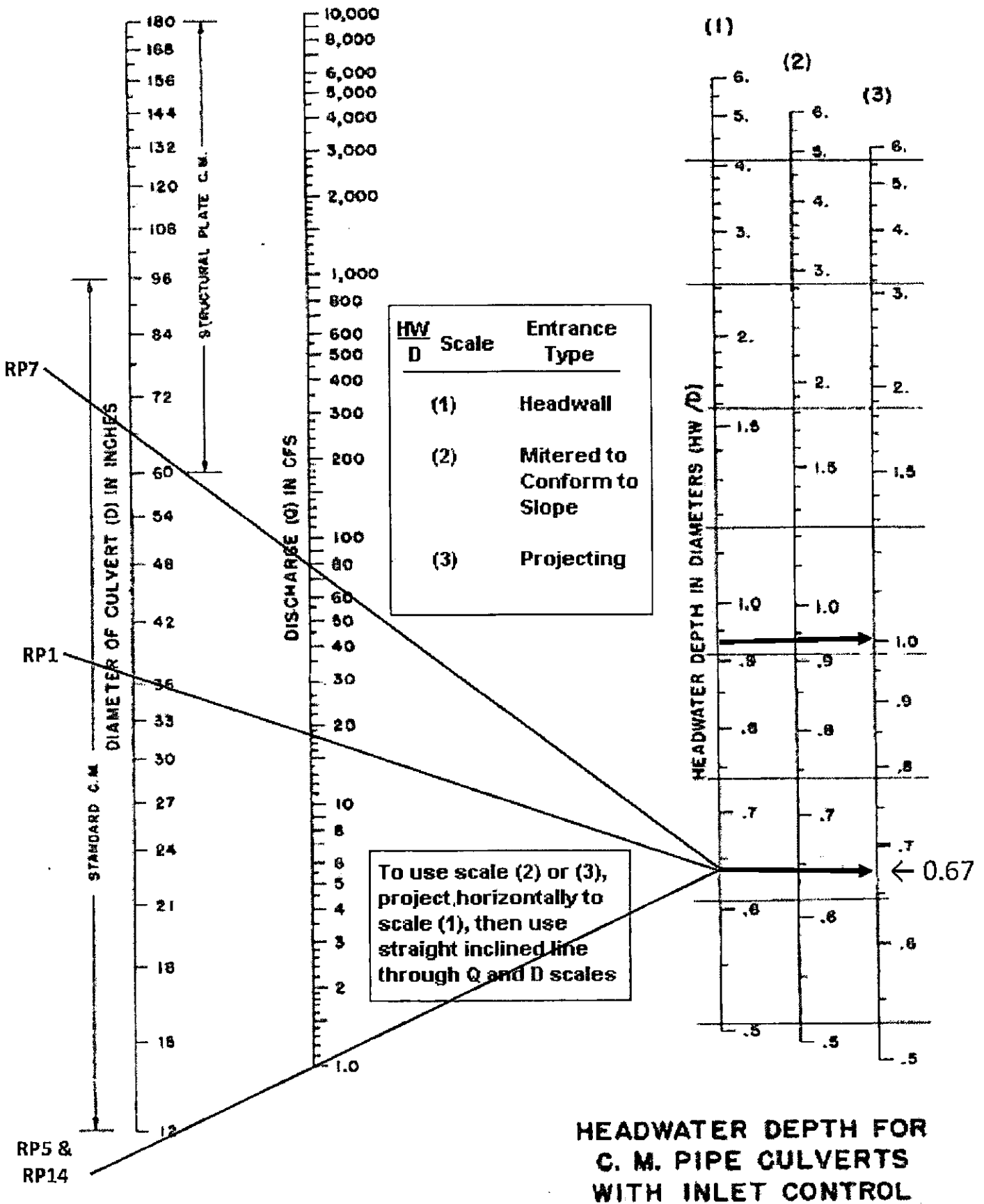





LIST 1  
DETAIL

1 Property Address: MIRANDA CA 95553

### Ownership

County: **HUMBOLDT, CA**  
 Assessor: **MARI WILSON, ASSESSOR**  
 Parcel # (APN): **221-011-021-000**  
 Parcel Status: **ACTIVE**  
 Owner Name: **INTEGRATED HORTICULTURE SYSTEMS LLC**  
 Mailing Address: **215 ANCHORAGE AVE SANTA CRUZ CA 95062**  
 Legal Description:

### Assessment

Total Value:	<b>\$363,208</b>	Use Code:	<b>7005</b>	Use Type:	<b>TIMBER PRESERVE</b>
Land Value:	<b>\$208,163</b>	Tax Rate Area:	<b>156-001</b>	Zoning:	
Impr Value:	<b>\$155,045</b>	Year Assd:	<b>2020</b>	Census Tract:	
Other Value:		Property Tax:	<b>\$4,106.64</b>	Price/SqFt:	
% Improved:	<b>42%</b>	Delinquent Yr:			
Exempt Amt:		HO Exempt:	<b>N</b>		

### Sale History

	Sale 1	Sale 2	Sale 3	Transfer
Document Date:	<b>06/22/2012</b>	<b>05/20/2011</b>		<b>05/04/2016</b>
Document Number:	<b>2012R15963</b>	<b>2011R10794</b>		<b>2016R08187</b>
Document Type:	<b>GRANT DEED</b>	<b>GRANT DEED</b>		
Transfer Amount:	<b>\$180,000</b>	<b>\$395,000</b>		
Seller (Grantor):	<b>JACOBSEN YOUNG J SM</b>			

### Property Characteristics

Bedrooms:		Fireplace:		Units:	
Baths (Full):		A/C:		Stories:	
Baths (Half):		Heating:		Quality:	
Total Rooms:		Pool:		Building Class:	
Bldg/Liv Area:		Park Type:		Condition:	
Lot Acres:	<b>80.000</b>	Spaces:		Site Influence:	
Lot SqFt:	<b>3,484,800</b>	Garage SqFt:		Timber Preserve:	
Year Built:				Ag Preserve:	
Effective Year:					

SECS. 1 & 2 T3S R2E

221-01

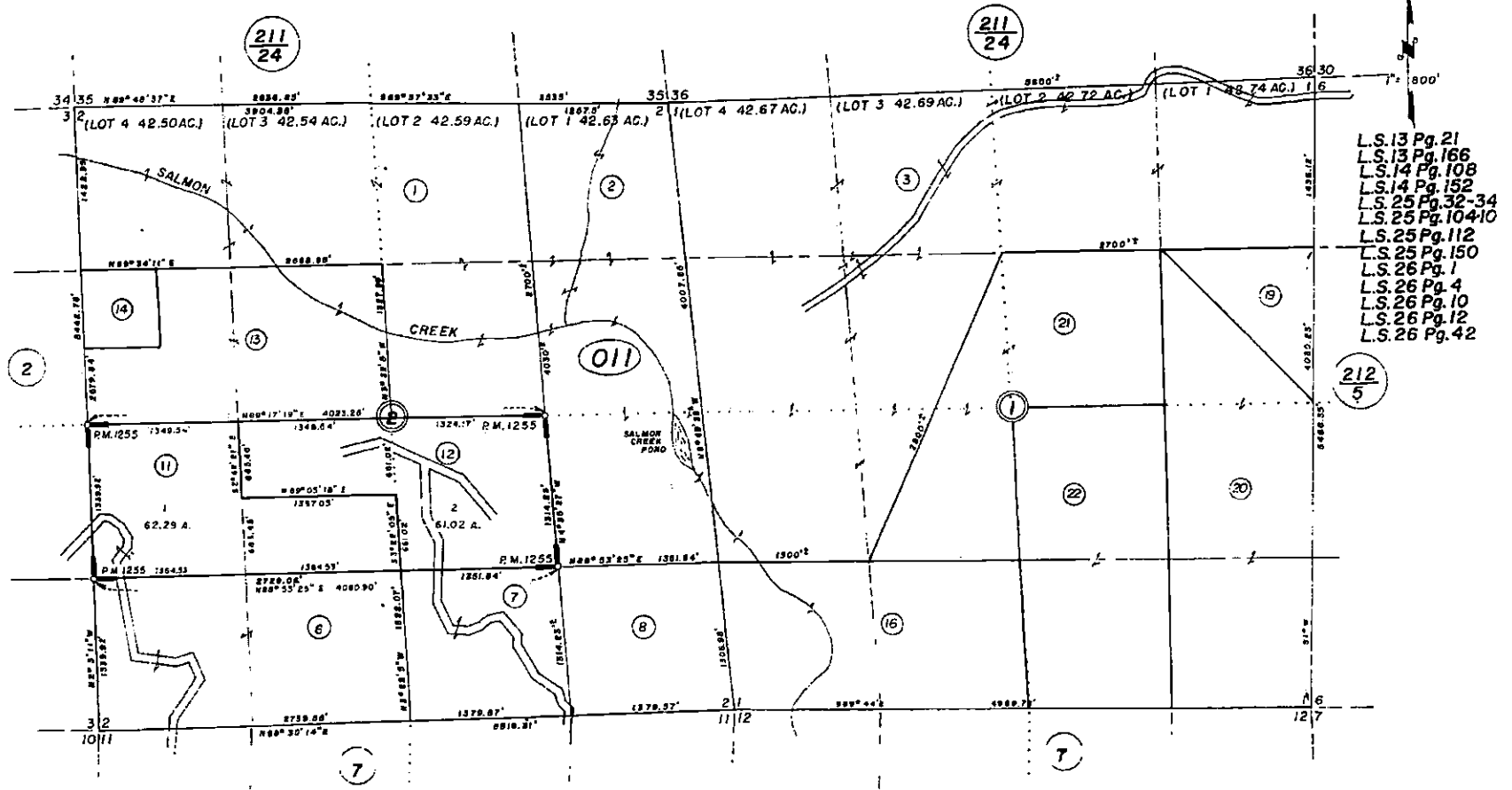

P.M. 1255 of P.M. Bk. 11, Pg. 33

Assessor's Maps Bk. 221 - Pg. 01  
County of Humboldt, Calif.

NOTE - Assessor's Block Numbers Shown in Ellipses  
Assessor's Parcel Numbers Shown in Circles



## 7. References

California Forest Practice rules, 2019; Title 14, California Code of Regulations, Chapters 4, 4.5, and 10

California Natural Diversity Database April 9, 2021 – <http://bios.dfg.ca.gov>

Parcel Quest Data – County Assessor information; <http://pqweb.parcelquest.com>

STATEMENT OF CONTINGENT AND LIMITING CONDITIONS CONCERNING THE PREPARATION AND USE OF THE RPF LESS THAN 3 AC CONVERSION MITIGATION PLAN

Prepared by Hohman & Associates

1. This information has been prepared for the sole use of the **Landowner of Record**, for the express purpose of submitting the document to CAL Fire and the local county planning department.
2. Hohman and Associates does not assume any liability for use of this information by any party other than the owner or their agent.
3. The assessment presented in this report should be viewed and considered in light of the time spent observing the property and the methodologies used. The assessment may differ from those made by others or from the results of interpretation and assessment protocols.
4. Hohman and Associates did not conduct an investigation on a legal survey of the property.
5. The information is based upon conditions apparent to Hohman and Associates at the time the work was done. This report is time sensitive and provides current conditions as per the date of this document. No further clearing of trees, grading or construction of structures shall occur on site until the approval of this document by CAL Fire and/or the local county planning department.
6. All future work on site shall be through **approved permits** with local state or county agencies.
7. Hohman and Associates shall not be responsible for the supervision of mitigation operations following approval of the conversion plan.
8. Signature page

Land Owner of Record: \_\_\_\_\_

Signature: \_\_\_\_\_ Date: \_\_\_\_\_

Registered Professional Forester: Stephen Hohman RPF #2652

Signature:  Date: 5-18-21

