

## **10. Walker Ridge Grant Application**

Project ranking criteria for (Project Title): \_\_\_\_\_

1. Does proposed project include one or more stream crossings and corrective grading within and close to a stream channel?

Yes  No

If yes: Number of stream crossings: \_\_\_\_\_

Corrective grading within and close to a stream channel: \_\_\_\_\_

2. Are improvements to roads in priority sub watersheds?

Yes  No

If yes: Which priority sub watershed: \_\_\_\_\_

Refuge sub watershed  Critical sub watershed

3. Is the proposed project maintained by a Road Maintenance Association?

Yes  No

If yes: Name of Road Maintenance Association: \_\_\_\_\_

Is the proposed project a cultivation sites approved under the 2016 Commercial Medical Marijuana Land Use Ordinance (CMMLUO) AND will the improvements bring the road into compliance with the standards?

Yes  No

If yes: What are the required standards/Conditions of Approval: \_\_\_\_\_

4. Is the proposed project located in an area of highly erodible soils, steep slopes, proximity to a watercourse(s), and have the presence of impacted fisheries?

Yes  No

If yes, check all that apply:

Highly erodible soils  Steep slopes  
 Proximity to a watercourse  Presence of impacted fisheries

Provide additional notes, if needed, based on boxes checked above: \_\_\_\_\_

\_\_\_\_\_  
\_\_\_\_\_

After evaluating the above, provide the following points (not to exceed one hundred total) based on the proposed project's:

- Project Design and Expected Outcomes – up to a total of 80 Points, based upon the project's alignment with the Program requirements and criteria set forth in these Guidelines.

Total score: \_\_\_\_\_

- Project Budget – up to a total of 10 Points, based on the applicant's ability to perform the work necessary to implement the project in a cost-efficient manner.

Total score: \_\_\_\_\_

- Experience and Capacity – up to 10 Points, based on the applicant's experience and capacity to perform the work necessary to implement the project.

Total score: \_\_\_\_\_

Total Final Ranking Score (out of 100 points): \_\_\_\_\_

# APPLICATION PACKET CHECKLIST

Please check below to ensure you have a complete application. Once complete, email the following documents, in pdf format with the text "Application for Remediation Grant Program Funding" in the subject line to [mrichardson@co.humboldt.ca.us](mailto:mrichardson@co.humboldt.ca.us).

- X Signed Application Submission Form
- X Project Description – Summary of the Project, up to 2 pages.
- X Plot Plan
- X Plot Plan Checklist – Attached
- X Cross sections of proposed work including topographic elevations
- X Scope of Work – Detailed Description of Work
- X Schedule for Completion – Identify Milestones
- X Erosion Control Plan and Monitoring Plan
- X Budget – Be as specific as possible – sample attached
- X Project Maps and Figures
- Letter(s) of Support (optional)

## APPLICATION FORM - Commercial Cannabis Land Use Ordinance Mitigation and Remediation Fund Program

Project Title: Walker Ridge Road Improvements Date of Application: 10/31/2021

Applicant Name: Walker Ridge Family Farm, LLC Project APN: 216-073-006

Contact Person Name and Title: Wesley Stoff

Contact Phone: (707) 223-1424 Contact Email: susanandwesley@gmail.com

Contact Address: P.O. Box 368, Redway, CA 95560

Amount Requested: \$67,486.00 Total Budget: \$77,486.00

Project Timeline: Start Date: June 1, 2022 End Date: August 1, 2022

Signature of Applicant:  \_\_\_\_\_

Walker Ridge Road Improvements  
Wesley Stoff  
APN: 216-073-006  
Project Description

The project is located on Humboldt County APN 216-073-006 near Harris, California. The subject parcel is located off of Bellus Road in the Tom Long Creek Watershed. The property contains several unnamed Class III tributaries to Tom Long Creek.

The project proposes the upgrade of culverts at seven stream crossings and the installation of armored fill at one other stream crossing on the property as required by the applicant's Lake and Streambed Alteration Agreement with the California Department of Fish & Wildlife.

GIS indicates the parcel is in an area of high slope instability. It is not within a flood hazard zone, nor in an earthquake hazard zone. The parcel is surrounded by rural improved properties. No impact to these other parcels is expected.

This project would stormproof stream crossings and reduce road-related sediment delivery to the Tom Long Creek Watershed. All of the crossing upgrades will be constructed according to standards provided in the "Handbook for Forest, Ranch and Rural Roads" (Weaver, Weppner and Hagans, 2015), and the California Salmonid Stream Habitat Manual, Part X (Weaver, Hagans and Weppner, 2006). Permanent impacts to existing native channel bed, channel, watercourse banks, and associated riparian habitat will be negligible and avoided. Incidental destruction of small areas of riparian habitat growing on existing road fill or in disturbed channel areas is expected at the proposed sites during remediation.

These upgraded watercourse crossings will achieve 100-year flood requirements and reduce sediment deposits into the streams that are connected to Tom Long Creek and flow to the East Branch of the Southfork of the Eel River, protecting water quality and aquatic ecosystems and limiting impact on downstream resources.

# Green Grove Family Farm

## APN: 216-073-006

### Plot Plan

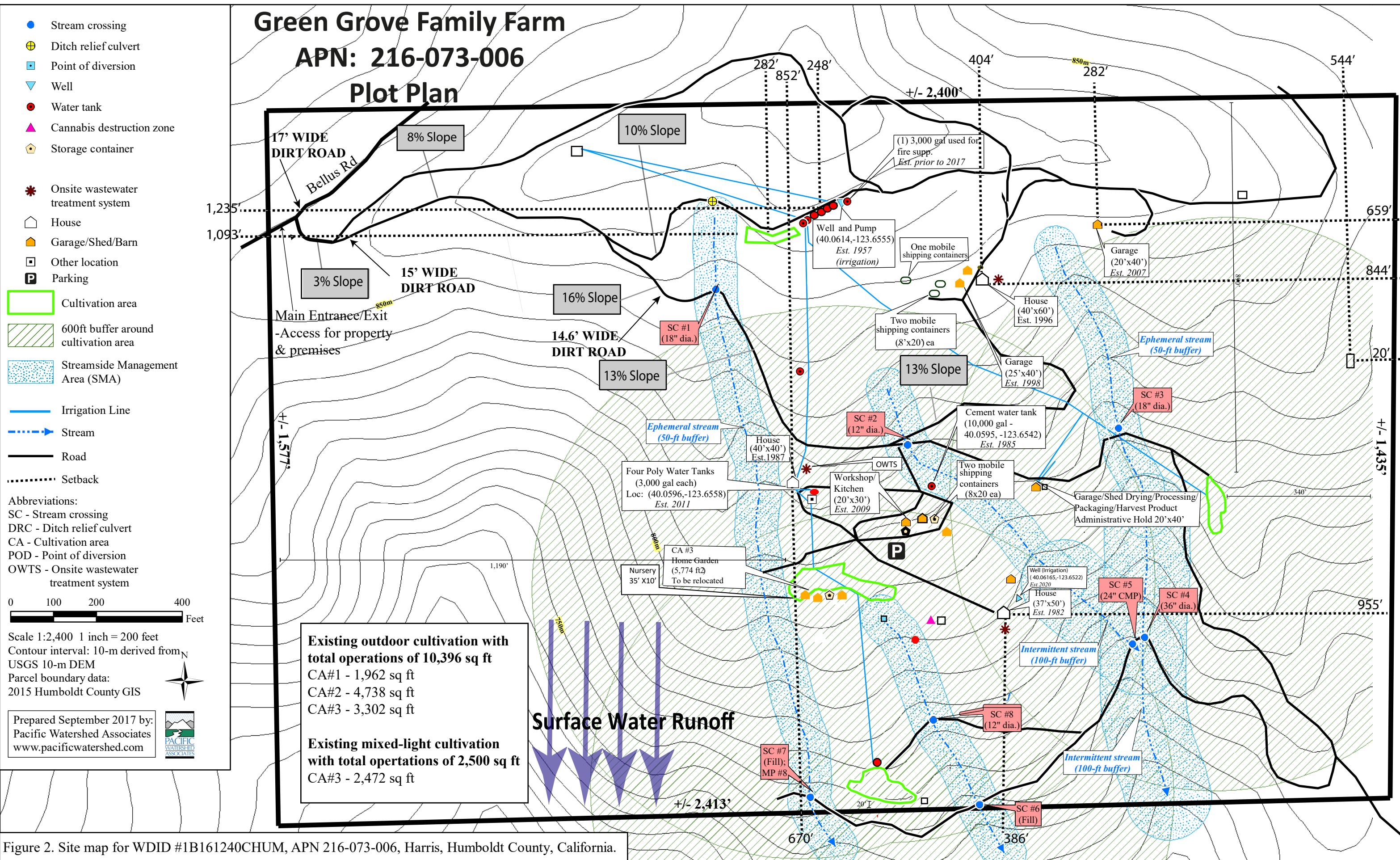

**Existing outdoor cultivation with total operations of 10,396 sq ft**  
 CA#1 - 1,962 sq ft  
 CA#2 - 4,738 sq ft  
 CA#3 - 3,302 sq ft

**Existing mixed-light cultivation with total operations of 2,500 sq ft**  
 CA#3 - 2,472 sq ft

### Surface Water Runoff

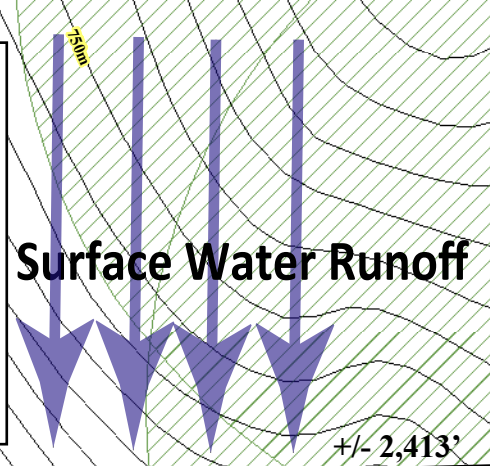
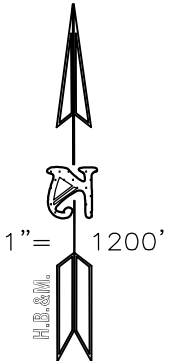
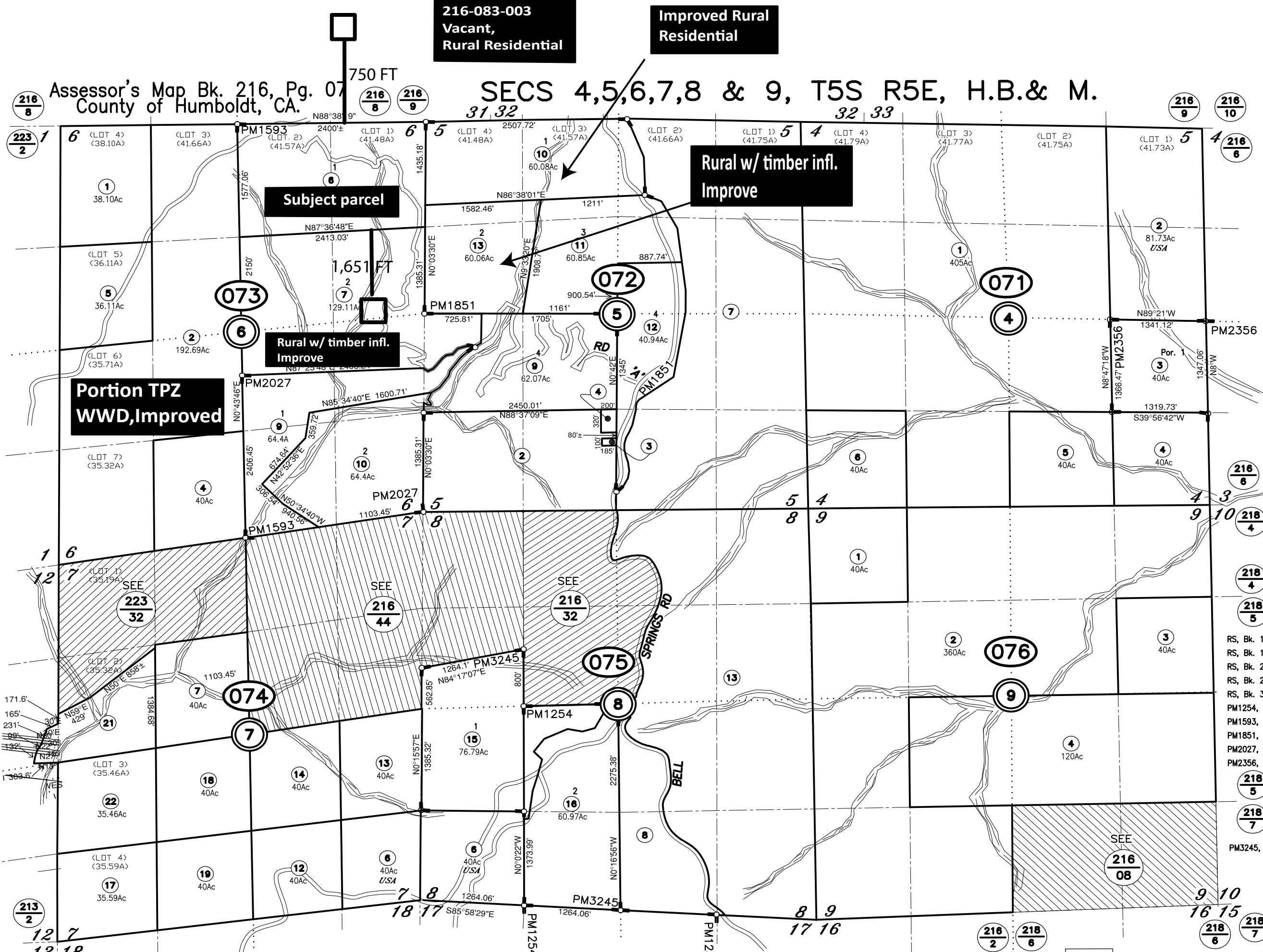

Figure 2. Site map for WDID #1B161240CHUM, APN 216-073-006, Harris, Humboldt County, California.

216-083-003  
Vacant,  
Rural Residential

Improved Rural  
Residential

SECS 4,5,6,7,8 & 9, T5S R5E, H.B.& M.



Wesley Stoft  
Walker Ridge Road Improvement  
Adjacent Parcels

- RS, Bk. 14 of Surveys, Pg. 113
- RS, Bk. 15 of Surveys, Pgs. 64-65
- RS, Bk. 25 of Surveys, Pg. 60
- RS, Bk. 29 of Surveys, Pg. 113
- RS, Bk. 30 of Surveys, Pg. 35-37
- PM1254, Bk. 11 of Parcel Maps, Pg. 31
- PM1593, Bk. 14 of Parcel Maps, Pg. 7
- PM1851, Bk. 16 of Parcel Maps, Pgs. 55-
- PM2027, Bk. 18 of Parcel Maps, Pgs. 2-3
- PM2356, Bk. 20 of Parcel Maps, Pgs. 143-
- PM3245, Bk. 30 of Parcel Maps, Pgs. 115

EC Apr 28, 20  
ERIN CEARLE

**ASSESSOR'S PARCEL**

- THIS MAP WAS PREPARED FOR ASSESSMENT PURPOSES ONLY.
- NO LIABILITY IS ASSUMED FOR THE ACCURACY OF THE DATA.
- ASSESSOR'S PARCELS MAY COMPLY WITH LOCAL LOT-, OR BUILDING SITE ORDINANCE.

NOTE - Assessor's Block Numbers Shown in Ellipses  
Assessor's Parcel Numbers Shown in Small Circles







**PLOT PLAN AND TENTATIVE MAP CHECKLIST**

The following information must be shown on your plot plan or tentative map. Please check ✓ the box to the left of the items shown on the plot plan or tentative map. If any item is not on your site to your knowledge, write "N/A" next to the box. Plot plans shall be drawn on a minimum size sheet of 8-1/2" x 11", and tentative subdivision maps on a minimum size sheet of 18" x 26". **Note: This Checklist must be completed by the applicant and submitted with your application.**

Applicant's Name  esley Stoft,  al er Ridge Road  prove  ents APN 21 -- -

|  |   |
|--|---|
| <b>FOR ALL PROJECTS</b>                        |   |
| <input type="checkbox"/>                       | 1. Name of applicant(s)   |
| <input type="checkbox"/>                       | 2. Location or vicinity map (on or attached to the plot plan)   |
| <input type="checkbox"/>                       | 3. The subject parcel (show entire parcel with dimensions)  |
| <input type="checkbox"/>                       | 4. Date, north arrow and scale  |
| <input type="checkbox"/>                       | 5. Name, County road numbers, and width of all existing and proposed access roadways adjacent to or within the subject parcel (indicate width of traveled way, grade (in % slope), and surface) |
| <input type="checkbox"/>                       | 6. Existing <u>and</u> proposed improvements (label as "existing" and "proposed" with dimensions and distance to nearest two (2) property lines)  |
| <input type="checkbox"/>                       | <input type="checkbox"/> a. Structures and buildings (include floor area, height and proposed use)  |
| <input type="checkbox"/>                       | <input type="checkbox"/> b. Driveways and turnaround areas (indicate width, grade (in % slope) and surface)   |
| <input type="checkbox"/>                       | <input type="checkbox"/> c. Utility lines (electric, gas, telephone, sewer, water, and cable TV)  |
| <input type="checkbox"/>                       | <input type="checkbox"/> d. Septic tanks and leachfields (label primary/reserve areas and test holes)   |
| <input type="checkbox"/>                       | <input type="checkbox"/> e. Wells   |
| <input type="checkbox"/>                       | <input type="checkbox"/> f. Parking and loading areas (show individual parking spaces, including handicapped parking and ramps)   |
| <input type="checkbox"/>                       | <input type="checkbox"/> g. Storm drains, curbs and gutters   |
| <input type="checkbox"/>                       | <input type="checkbox"/> h. Emergency water storage tanks and fire hydrants   |
| <input type="checkbox"/>                       | <input type="checkbox"/> i. Landscaped areas (include proposed exterior lighting)   |
| <input type="checkbox"/>                       | <input type="checkbox"/> j. Major vegetation (identify mature trees (12" dbh or larger) to be removed)  |
| <input type="checkbox"/>                       | <input type="checkbox"/> k. Diked areas   |
| <input type="checkbox"/>                       | <input type="checkbox"/> l. Proposed grading and fill (estimate volume)   |
| <input type="checkbox"/>                       | <input type="checkbox"/> m. Signs (indicate size, illuminated, and design (e.g., monument, pylon, etc.))  |
| <input type="checkbox"/>                       | <input type="checkbox"/> n. Other - specify _____   |
| <input type="checkbox"/>                       | 7. Direction of surface water runoff  |
| <input type="checkbox"/>                       | <input type="checkbox"/> 8. Location and width of all existing and proposed easements of record   |
| <input type="checkbox"/>                       | 9. Hazardous areas (indicate on map if on the project site <u>or</u> within 400 feet of the project site):  |
| <input type="checkbox"/>                       | <input type="checkbox"/> a. Areas subject to inundation or flooding   |
| <input type="checkbox"/>                       | <input type="checkbox"/> b. Steep or unstable slopes  |
| <input type="checkbox"/>                       | <input type="checkbox"/> c. Expansive (clay) soils  |
| <input type="checkbox"/>                       | <input type="checkbox"/> d. Earthquake faults   |
| <input type="checkbox"/>                       | <input type="checkbox"/> e. Hazardous waste or substance sites  |
| <input type="checkbox"/>                       | <input type="checkbox"/> f. Other - specify _____   |
| <input type="checkbox"/>                       | 10. Sensitive habitat areas (indicate on map if on project site <u>or</u> within 400 feet of the project site):   |
| <input type="checkbox"/>                       | <input type="checkbox"/> a. Creeks, rivers, sloughs and other drainage courses  |
| <input type="checkbox"/>                       | <input type="checkbox"/> b. Lakes, ponds, marshes, or "wet" meadows   |
| <input type="checkbox"/>                       | <input type="checkbox"/> c. Beaches   |
| <input type="checkbox"/>                       | <input type="checkbox"/> d. Sand dunes  |
| <input type="checkbox"/>                       | <input type="checkbox"/> e. Other - specify _____   |
| <input type="checkbox"/>                       | 11. Historical buildings or known archaeological or paleontological resources   |
| <input type="checkbox"/>                       | 12. Land use and buildings on adjacent parcels, and approximate distances to closest property lines   |
| <b>FOR LOT LINE ADJUSTMENT PLOT PLANS ONLY</b> |   |
| <input type="checkbox"/>                       | 13. Proposed new lines and lines to be eliminated (show lines to be eliminated as dashed)   |
| <input type="checkbox"/>                       | 14. Areas (in square footage or acreage) of the initial and resulting parcels   |

|  |   |
|--|---|
| <b>FOR TENTATIVE SUBDIVISION MAPS ONLY</b> |   |
| <input type="checkbox"/>                   | 16. Approximate dimensions and areas of all proposed lots   |
| <input type="checkbox"/>                   | 17. A statement that "All easements of record are shown on the tentative map and will appear on the recorded subdivision map"   |
| <input type="checkbox"/>                   | 18. Contour lines (at _____ intervals)  |
| <input type="checkbox"/>                   | 19. For major subdivisions (5 or more parcels): proposed drainage improvements, details of any grading to be performed, approximate radii of all roadway curves, areas for public use, and typical sections of all streets, highways, ways and alleys |
| <input type="checkbox"/>                   | 20. Names and assessor's parcel numbers of all contiguous ownerships  |

**NOTE: THE SUBMITTAL OF INCOMPLETE OR ILLEGIBLE PLOT PLANS OR TENTATIVE MAPS WILL CAUSE DELAYS IN THE PROCESSING OF YOUR APPLICATION**

Walker Ridge Road Improvements  
Applicant: Wesley Stoff  
APN: 216-073-006  
Mitigation and Remediation Fund  
Scope of Work

The work will be completed by MS Excavation.

Crossing #1 - removal and replacement of an 18-inch culvert with a 50 foot, 24-inch culvert on a near origin Class III watercourse. The culvert was installed high and short in the fill, causing ponding at the inlet and a 3 foot plunge at the outlet. The crossing has a functional critical dip on the left hingeline and an insloped right road approach, which conveys road runoff to the culvert inlet through the inboard ditch.

The stream crossing will be replaced with a 24-inch diameter by 50 foot long culvert set at the base of the fill and in line with the natural channel. The lower  $\frac{3}{4}$  of the outboard fillslope will be armored with 15 cubic yards of .5-1.5 foot diameter riprap to minimize erosion of the road fill. The crossing will be rebuilt with a critical dip on the left hingeline, to prevent diversion in the event the culvert plugs or its capacity is exceeded.

Crossing #2 - removal and replacement of a 12-inch diameter culvert with a 24-inch diameter culvert on a near origin Class III watercourse. The culvert is installed short and high in the fill, with diversion potential down the left road.

The stream crossing will be replaced with a 24-inch diameter by 50 foot long culvert set at the base of fill and in line with the natural channel. The road prism will need to be raised 1.5 feet with approximately 15 cubic yards of locally generated fill to accommodate the new, larger pipe. The crossing will be rebuilt with a critical dip on the left hingeline, to prevent diversion in the event the culvert plugs or its capacity is exceeded.

Crossing #2b - a near origin, Class III watercourse with no formal drainage structure. This road alignment is located upstream of Stream Crossing #2 (approximately 50') and is a seasonally used quad trail. There is diversion potential down the right road at this site.

An armored fill will be installed at this location to route flow across the roadbed in a way that prevents the diversion of streamflow out of the stream channel and protects the road fill from erosion by creating a broad dip through the road prism and excavating a small keyway in the outboard fill. Dimensions for the keyway will be approximately 10 feet wide at the top, 4 feet wide at the base, 1 foot deep, and 15 feet long. The keyway will be armored with 10 cubic yards of .5-1.5 diameter riprap to accommodate for seasonal stream flow.

Crossing #3 - an undersized, 18-inch diameter culvert on a Class III watercourse. The culvert was installed high and short in the fill and diversion potential exists down the left road.

The stream crossing will be replaced with a 36-inch diameter by 30 foot long culvert set at the base of fill and in line with the natural channel. The entire inboard and outboard fillslopes will be armored with 5 and 15 cubic yards of .5-1.5 foot diameter riprap, respectively. To prevent diversion potential, the crossing will have a critical dip installed on the left hingeline.

Crossing #5 - A 24-inch diameter plastic culvert on a Class III watercourse, installed at the base of fill, and in-line with the natural channel. The culvert is slightly undersized for the 100 year peak streamflow and associated debris.

The stream crossing will be replaced with a 30-inch diameter by 40 foot long culvert set at the base of fill and in line with the natural channel. The lower  $\frac{1}{4}$  of the inboard and outboard fillslopes will be armored with 2 and 5 cubic yards of .5-1.5 foot diameter riprap, respectively, to protect the road fill from erosion.

Crossing #7 - a Class III watercourse crossing with no formal drainage structure. This crossing is just within the landowner's property boundary, as delineated by the recent parcel boundary survey flags, and is only used seasonally by the neighbors on the adjacent parcel.

The stream crossing will be replaced with a 30-inch diameter by 40 foot long culvert set at the base of fill and in line with the natural channel. The lower  $\frac{1}{4}$  of the inboard and outboard fillslopes will be armored with 2 and 5 cubic yards of .5-1.5 foot diameter riprap, respectively, to protect the road fill from erosion.

Crossing #8 - a partially plugged, 12-inch diameter culvert on a Class III watercourse. The culvert was installed high and short in the fill.

The stream crossing will be replaced with a 24-inch diameter by 20 foot long culvert set at the base of the fill and in line with the natural channel. The lower  $\frac{3}{4}$  of the outboard fillslope will be armored with 5 cubic yards of .5-1.0 foot diameter riprap to protect the road fill from erosion.

Crossing #9 - A 36-inch diameter plastic culvert on a Class III watercourse. The culvert is slightly undersized for the 100 year peak streamflow and associated debris, is installed at the base of fill, and in-line with the natural channel.

The stream crossing will be replaced with a 48-inch diameter by 50 foot long culvert set at the base of fill and in line with the natural channel. The lower  $\frac{3}{4}$  of the inboard and outboard fillslopes will be armored with 10 and 15 cubic yards of .5-2 foot diameter riprap, respectively.

During the project, care will be taken not to unnecessarily disturb the native channel outside of the identified areas. Fill to be permanently removed will be stored in designated locations with no risk of sediment delivery. All disturbed areas where sediment delivery from surface erosion processes is feasible will be seeded and mulched to reduce surface erosion and transport processes.

The proposed crossing upgrades will occur on in-use roads. All disturbance associated with this project will be limited to the road and immediately adjacent channel reaches as necessary to improve road drainage, stormproof the crossings, and prevent sediment delivery to watercourses. All stream crossings will be dry at time of construction. Work will only occur during the period of June 15 through October 15 (or first significant rainfall) to limit and avoid impacts to aquatic habitat and salmonids. Vegetation will only be removed from sites where it is growing on anthropogenically placed fill material, where erosion is likely to deliver to active watercourses, or where necessary for the implementation of effective storm-proofing treatments.

Walker Ridge Road Improvements  
Applicant: Wesley Stoff  
APN: 216-073-006  
Mitigation and Remediation Fund  
Schedule for Completion

| Milestone                | Start Date    | End Date       |
|--------------------------|---------------|----------------|
| Detailed Project Scoping | March 1, 2022 | March 30, 2022 |
| Bidding and Contracting  | March 1, 2022 | March 30, 2022 |
| Project Ground-Breaking  | June 1, 2022  |                |
| Project Completion       |               | August 1, 2022 |
| Monitoring               | June 1, 2022  | Ongoing        |

# Five-Year Erosion Control Plan

## Project Management

Before and during the project best practices will be applied to ensure minimal disturbance to the waterway and local habitat.

- Work will be completed prior to the start of any rain that causes overland flow across or along the disturbed surface.
- Within 100 feet of a watercourse or lake, the traveled surface of roads will be treated to prevent waterborne transport of sediment and concentration of runoff that results from operations.
- The treatment for disturbed areas within 100 feet of a watercourse including (1) areas exceeding 100 contiguous square feet where operations have exposed bare soil, (2) road cut banks and fills, and (3) any other area of disturbed soil that threatens to discharge sediment into waters in amounts that will negatively affect the quality and beneficial uses of water, shall be grass seeded and mulched with straw.
  - Grass seed shall be applied at a rate exceeding 100 pounds per acre.
  - Straw mulch shall be applied in amounts sufficient to provide at least 2-4 inch depth of straw with minimum 90% coverage.
  - Slash may be substituted for straw mulch provided the depth, texture, and ground contact are equivalent to at least 2-4 inches of straw mulch.
  - Any treated area that has been subject to reuse or has less than 90% surface cover shall be treated again prior to the end of operations.
- Care will be taken not to unnecessarily disturb the native channel outside of the identified areas.
- Fill to be permanently removed will be stored in designated locations with no risk of sediment delivery.
- All disturbed areas where sediment delivery from surface erosion processes is feasible will be seeded and mulched to reduce surface erosion and transport processes.
- All disturbance associated with this project will be limited to the road and immediately adjacent channel reaches as necessary to improve road drainage, stormproof the crossings, and prevent sediment delivery to watercourses.
- Any spoils generated during construction will be used for road treatments, such as shaping, or stored in a stable location and mulched to prevent surface erosion.
- The stream crossing will be treated according to standards provided in the “Handbook for Forest, Ranch and Rural Roads” (Weaver, Weppener and Hagans, 2015) and the California Salmonid Stream Habitat Manual, Part X (Weaver, Hagans and Weppner, 2006).

## Roads

- Sidecast or fill material extending more than 20 feet in slope distance from the outside edge of a roadbed, which has access to a watercourse or lake, shall be treated with slope stabilization measures.

- All roads shall have drainage and/or drainage collection and storage facilities installed as soon as practical following operations and prior to either (1) the start of any rain which causes overland flow across or along the disturbed surface within 100 feet of a watercourse, or (2) any day with a National Weather Service forecast of a chance of rain of 30 percent or more, a flash flood warning or a flash flood watch.

### **Streamside Management Area**

- Within 100 feet of a watercourse, where the undisturbed natural ground cover cannot effectively protect beneficial uses of water from sediment introduction, the ground shall be treated with slope stabilization measures and timed as above.
- Except for culvert repairs and maintenance, no driving or operating of vehicles or equipment will occur within the riparian setbacks or within waters of the state unless authorized.

### **Maintenance**

- Work will only occur during the period of June 15 through October 15 (or first significant rainfall) to limit and avoid impacts to aquatic habitat and salmonids.
- Vegetation will only be removed from sites where it is growing on anthropogenically placed fill material, where erosion is likely to deliver to active watercourses, or where necessary for the implementation of effective storm-proofing treatments.
- All disturbed areas capable of delivering sediment to a watercourse will be seeded with barley or wheat based erosion control seed not containing Annual or Perennial Ryegrass and mulched with weed free straw at a rate no less than 50 lb/acre of seed and 4,000 lb/acre of straw.

### **Monitoring**

To avoid risk of future stream diversions and erosion, monitoring will be implemented to reduce the risk of stream crossing failures caused by excessive flow, culvert plugging, overtopping, washout and stream diversion.

- Regular, periodic, and storm inspections and maintenance, including removal of debris.
- Ongoing monitoring for proper drainage during the rainy season.
- Installation of debris barriers.
- Monitor culverts for rusting, leaking, separated or other signs of impending failure.
- Look for evidence of plugging and overtopping, such as depositional terraces or a delta of sediment upstream of the pipe inlet.
- Look for ponding, damage to inlets, including crushed or ripped inlets.
- Monitor crossing for slope failure from one or both sides of the channel.

Walker Ridge Road Improvements  
Applicant: Wesley Stoff  
APN 216-073-006  
Project Budget

| <b>Budget Item</b>               | <b>Grant</b> | <b>Other Funds</b>         |
|----------------------------------|--------------|----------------------------|
| Permit Fees                      |              |                            |
| 401 Certification                | \$2,066.00   |                            |
| Consultant and Professional Fees | \$11,500.00  |                            |
| Materials                        | \$ 30,100.00 |                            |
| Equipment                        | \$ 26,320.00 |                            |
| Labor                            | \$ 7,500.00  |                            |
| Total                            | \$77,486.00  | Trellis Equity \$10,000.00 |
| Total Requested                  | \$67,486.00  |                            |



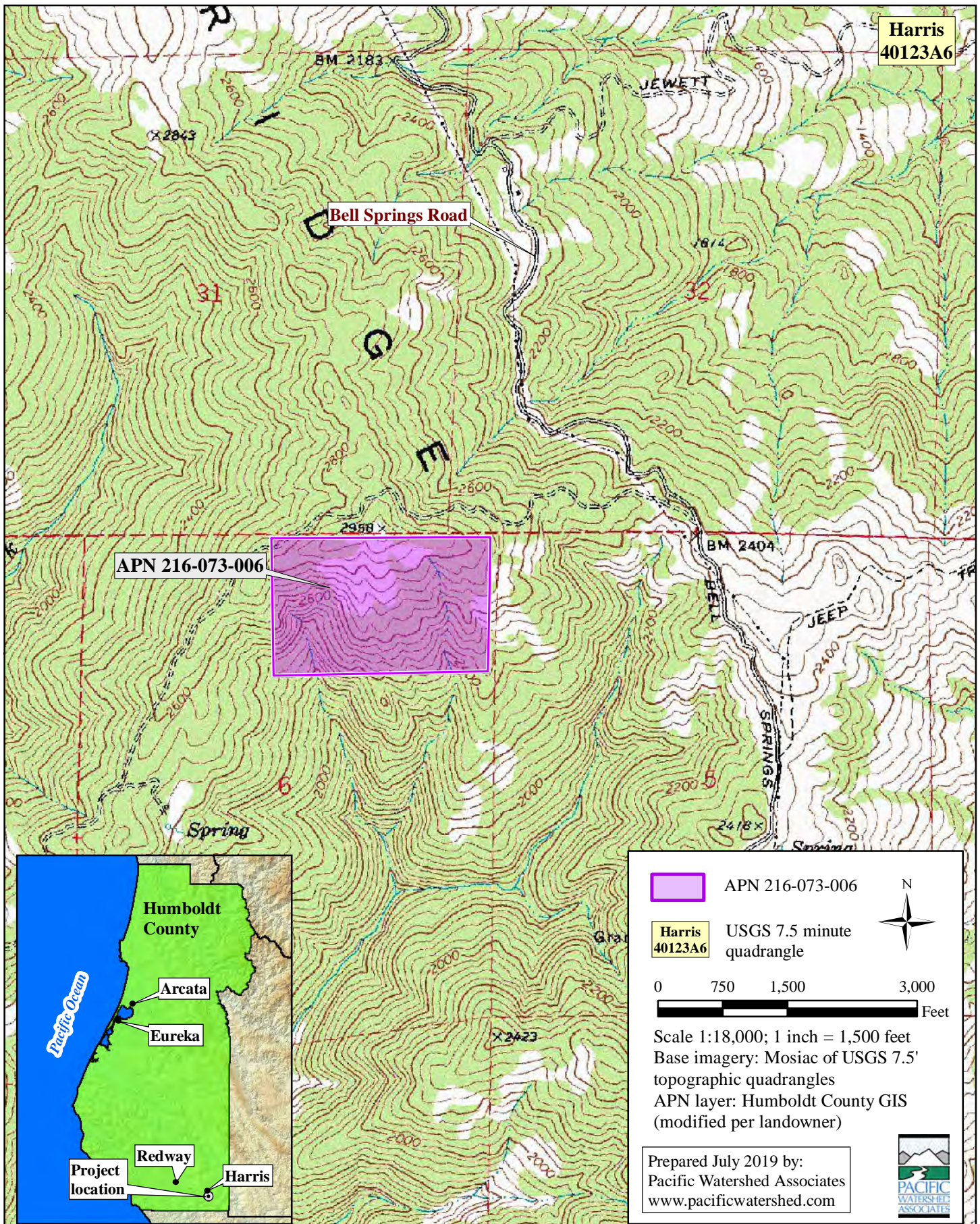

Figure 1. Location map for W. Stoft Lake or Streambed Alteration Agreement, APN 216-073-006, Harris, Humboldt County, California.



# Stoft Topo Map

Humboldt County Planning and Building Department

Printed: October 11, 2021

Web AppBuilder 2.0 for ArcGIS

Map Disclaimer:  
While every effort has been made to assure the accuracy of this information, it should be understood that it does not have the force & effect of law, rule, or regulation. Should any difference or error occur, the law will take precedence.

- |                           |                           |                                  |                  |
|---------------------------|---------------------------|----------------------------------|------------------|
| <b>Highways and Roads</b> | — Private or Unclassified | — Subsurface                     | — Major Interval |
| — Principal Arterials     | — Major River or Stream   | — City Boundary                  |                  |
| — Minor Arterials         |                           | — Counties                       |                  |
| — Major Collectors        |                           | — Parcels (no APN labels)        |                  |
| — Minor Collectors        |                           | <b>Topographic Contours 40ft</b> |                  |
| — Local Roads             |                           | — Minor Interval                 |                  |
| <b>Blue Line Streams</b>  | — Perennial 1-3           |                                  |                  |
|                           | — Perennial >4            |                                  |                  |
|                           | — Intermittent            |                                  |                  |

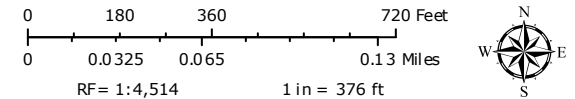

Sources: Source: Esri, Maxar, GeoEye, Earthstar Geographics, CNES/Airbus DS, USDA, USGS, AeroGRID, IGN, and the GIS User Community  
Humboldt County GIS  
Esri, HERE, Garmin, (c) OpenStreetMap contributors, and the GIS user community  
FRAP, FEMA, USGS, ESA, CGS

Figure 2 - Topographic Map

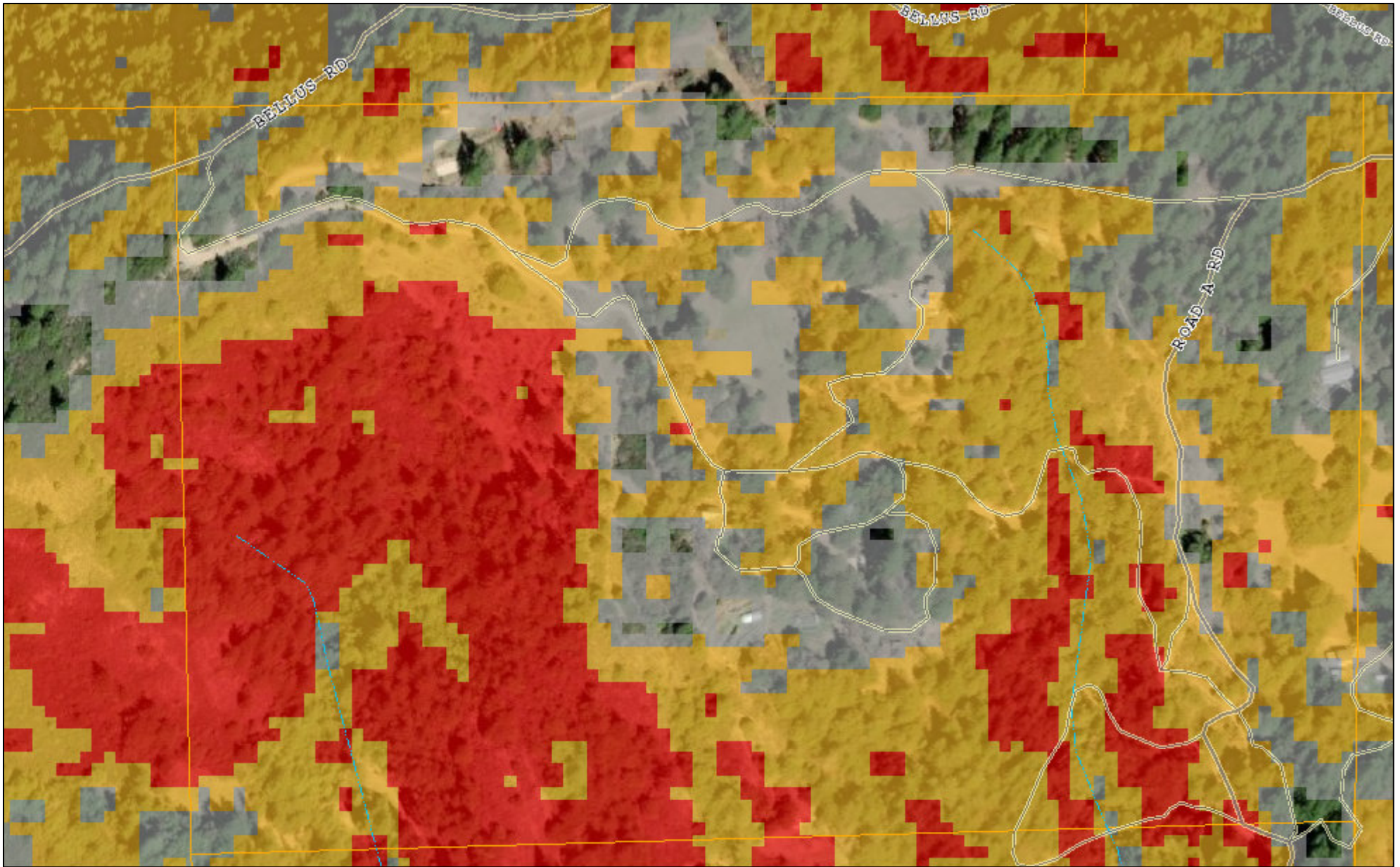

## Stoft Slope Map

Humboldt County Planning and Building Department

Printed: October 11, 2021

Web AppBuilder 2.0 for ArcGIS

**Map Disclaimer:**

While every effort has been made to assure the accuracy of this information, it should be understood that it does not have the force & effect of law, rule, or regulation. Should any difference or error occur, the law will take precedence.

**Highways and Roads**

Principal Arterials

Minor Arterials

Major Collectors

Minor Collectors

Local Roads

Private or Unclassified

Major River or Stream

**Blue Line Streams**

Perennial 1-3

Perennial >4

Intermittent

Subsurface

City Boundary

Counties

Parcels (no APN labels)

0 180 360 720 Feet

0 0.0325 0.065 0.13 Miles

RF= 1:4,514

1 in = 376 ft



Sources: Source: Esri, Maxar, GeoEye, Earthstar Geographics, CNES/Airbus DS, USDA, USGS, AeroGRID, IGN, and the GIS User Community  
Humboldt County GIS  
Esri, HERE, Garmin, (c) OpenStreetMap contributors, and the GIS user community  
FRAP, FEMA, USGS, ESA, CGS

Figure 3 - Slope Map

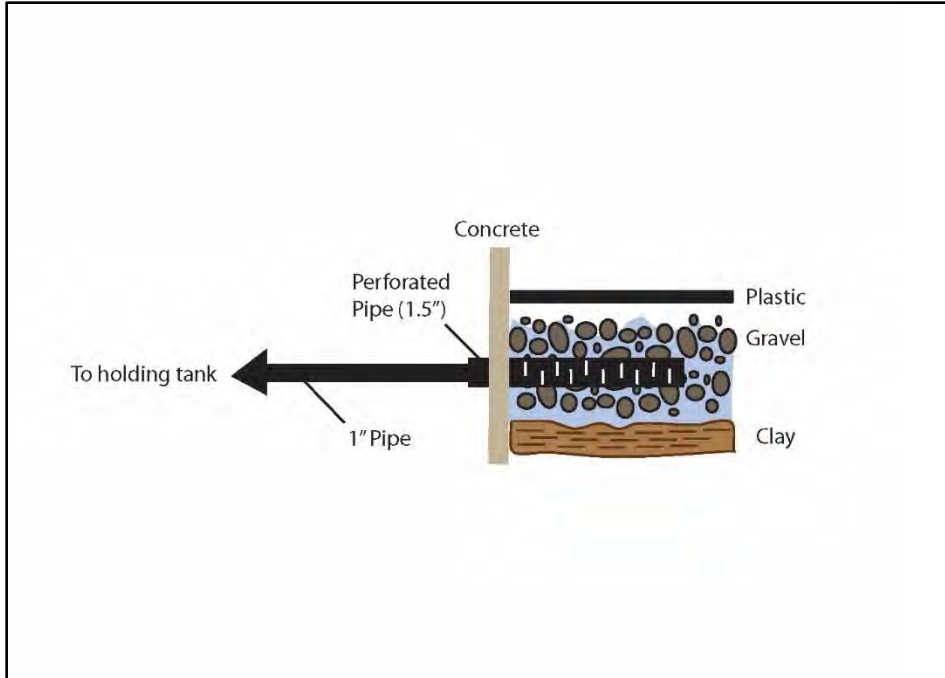

**Photo 3** – Project #1, description of the POD #1 domestic diversion structure.

### Stream Crossings



**Photo 4** – Project #2, View of Stream Crossing (SC) #1 looking downstream towards the culvert inlet.



**Photo 5** – Project #2, View of SC #1 from the right road approach. Note the culvert outlet (arrow) set high in the outboard fill face.



**Photo 6** – Project #3, View of the inlet of SC #2 from the right road inboard ditch, which is actively delivering fine sediment to the crossing.



**Photo 7** – Project #3, View looking upstream from the outlet of SC #2.



**Photo 8** – Project #4, View of the fill crossing, SC #2B from the right road. Note the flow direction depicted by the arrow. This crossing is on a quad trail used seasonally by the applicant to get to House #2 from House #1.



**Photo 9** – Project #5, View looking downstream at SC #3 culvert inlet.



**Photo 10** – Project #5, View from the right road looking at the SC #3 culvert outlet set high and short in the fill.



**Photo 11** – Project #6, View looking upstream of SC #5 culvert inlet (arrow).



**Photo 12** – Project #6, View from right road looking at SC #5 (lower arrow) culvert outlet, set at the base of fill. Note the upper arrow shows disclosure point SC #4 culvert outlet, also set at the base of fill.





**Photo 13** – Project #7, View from the right road looking at SC #7. Note the flow direction depicted by the arrow, and the pink property boundary flag in the foreground.



**Photo 14** – Project #7, View from the base of fill at SC #7 looking upslope at the outboard fill face.



**Photo 15** – Project #8, View looking downstream at SC #8 plugged culvert inlet.



**Photo 16** – Project #8, View looking downstream at SC #8 culvert outlet.



**Photo 17** – Project #9, View looking downstream at SC #9 culvert inlet.



**Photo 18** – Project #9, View looking upstream at SC #9 culvert outlet, set at the base of fill.

Figure 4H - Photographs

# Typical Problems and Applied Treatments for a Non-fish Bearing Upgraded Stream Crossing

## Problem condition (before)

- A - Diversion potential
- B - Road surface and ditch drain to stream
- C - Undersized culvert high in fill with outlet erosion

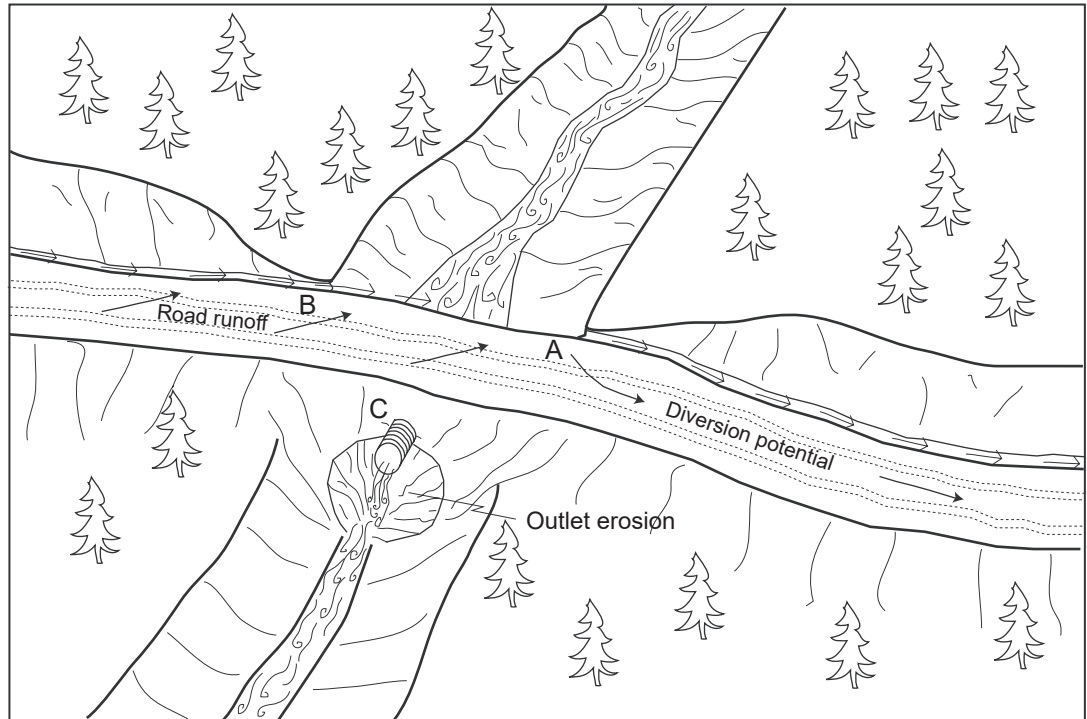

## Treatment standards (after)

- A - No diversion potential with critical dip installed near hingeline
- B - Road surface and ditch disconnected from stream by rolling dip and ditch relief culvert
- C - 10-year culvert set at base of fill

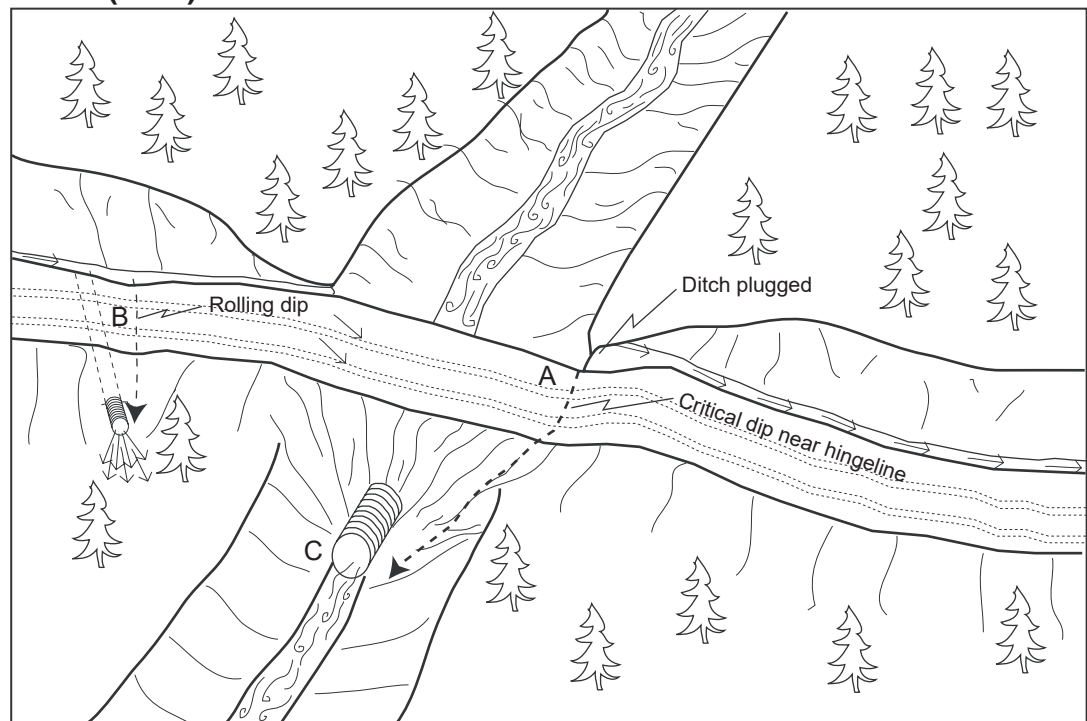

Pacific Watershed Associates Inc.

Geologic and Geomorphic Studies • Watershed Restoration • Wildland Hydrology • Erosion Control • Environmental Services  
 PO Box 4433, Arcata, CA 95518 / Ph: 707-839-5130 / FAX: 707-839-8168 / www.pacificwatershed.com

PWA Typical Drawing #1a

Figure 5A - Culvert Specifications

# Typical Design of a Non-fish Bearing Culverted Stream Crossing

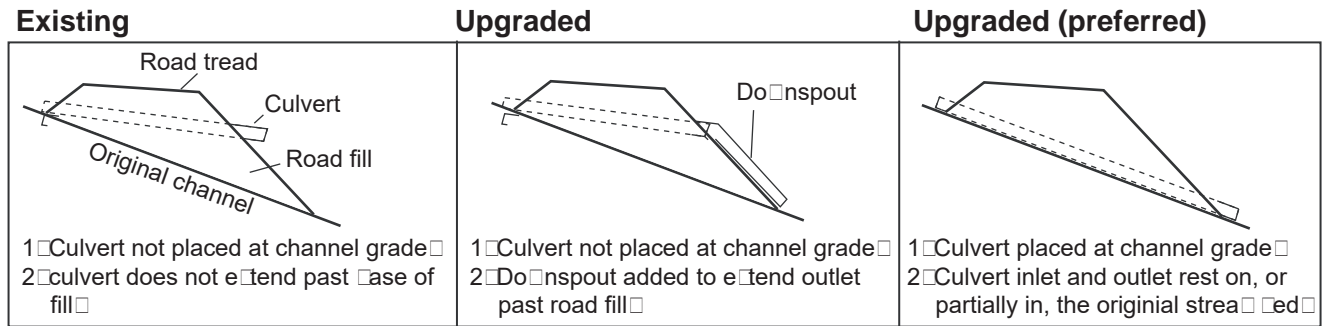

## Excavation in preparation for upgrading culverted crossing

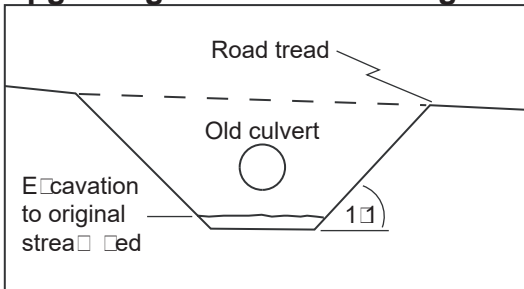

## Upgraded stream crossing culvert installation

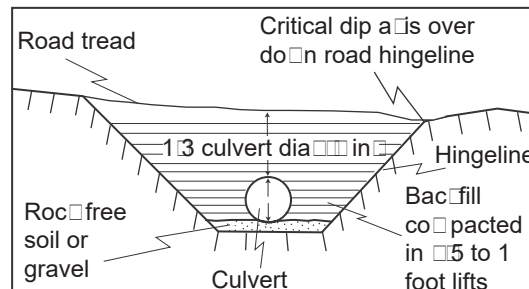

Note

Road upgrading tasks typically include upgrading stream crossings by installing larger culverts and inlet protection (trash carriers) to prevent plugging. Culvert sizing for the 100-year peak storm flow should be determined by both field observation and calculations using a procedure such as the Rational Formula.

## Stream crossing culvert Installation

- Culverts shall be aligned with natural stream channels to ensure proper function, and prevent bank erosion and plugging by debris.
- Culverts shall be placed at the base of the fill and the grade of the original stream bed, or dropspouted past the base of the fill.
- Culverts shall be set slightly below the original stream grade so that the water drops several inches as it enters the pipe.
- To allow for sagging after burial, a camber shall be set between 1.5 to 3 inches per 100 feet culvert pipe length.
- Backfill material shall be free of rocks, lumps or other debris that could dent or puncture the pipe or allow water to seep around pipe.
- First one end then the other end of the culvert shall be covered and secured. The center is covered last.
- Backfill material shall be tamped and compacted throughout the entire process.
  - Base and side wall material will be compacted before the pipe is placed in its bed.
  - Backfill compacting will be done in 5 - 1 foot lifts until 1/3 of the diameter of the culvert has been covered. A gas powered tamper can be used for this work.
- Inlets and outlets shall be armored with rock or mulched and seeded with grass as needed.
- Trash protectors shall be installed just upstream from the culvert where there is a hazard of floating debris plugging the culvert.
- Layers of fill will be pushed over the crossing until the final designed road grade is achieved, at a minimum of 1/3 to 1/2 the culvert diameter.

## Erosion control measures for culvert replacement

Both mechanical and vegetative measures will be employed to minimize accelerated erosion from stream crossing and ditch relief culvert upgrading. Erosion control measures implemented will be evaluated on a site by site basis. Erosion control measures include but are not limited to:

- Minimizing soil exposure by limiting excavation areas and heavy equipment disturbance.
- Installing filter drains of slash at the base of the road fill to minimize the movement of eroded soil to downslope areas and stream channels.
- Retaining rooted trees and shrubs at the base of the fill as anchor for the fill and filter drains.
- Bare slopes created by construction operations will be protected until vegetation can stabilize the surface. Surface erosion on exposed cuts and fills will be minimized by mulching, seeding, planting, compacting, arroyoing, and/or benching prior to the first rains.
- Excess or unusable soil will be stored in long term spoil disposal locations that are not limited by factors such as excessive moisture, steep slopes greater than 1:1, archeology potential, or proximity to a watercourse.
  - On running streams, water will be pumped or diverted past the crossing and into the downstream channel during the construction process.
  - Straw bales and/or silt fencing will be employed where necessary to control runoff within the construction zone.

Pacific Watershed Associates Inc.

Geologic and Geomorphic Studies • Watershed Restoration • Wildland Hydrology • Erosion Control • Environmental Services  
PO Box 4433, Arcata, CA 95518 / Ph: 707-839-5130 / FAX: 707-839-8168 / www.pacificwatershed.com

Typical Drawing #2

Figure 5B - Culvert Specifications

# Typical Design of Upgraded Stream Crossings

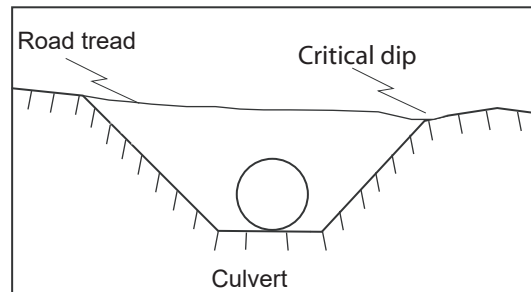
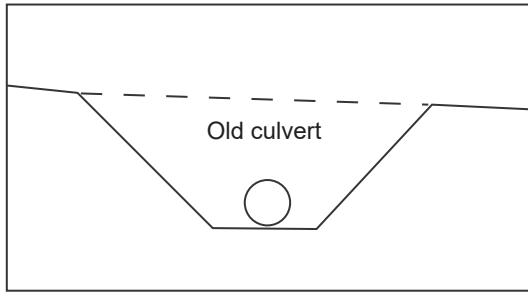

## Stream crossing culvert Installation

1. Culverts shall be aligned with natural stream channels to ensure proper function, and prevent bank erosion and plugging by debris.
2. Culverts shall be placed at the base of the fill and the grade of the original stream bed or downstream past the base of the fill.
3. Culverts shall be set slightly below the original stream grade so that the water drops several inches as it enters the pipe.
5. To allow for sagging after burial, a camber shall be set between 1/5 to 3 inches per 10 feet culvert pipe length.
- Backfill material shall be free of rocks, lumps or other debris that could dent or puncture the pipe or allow water to seep around pipe.
- First one end and then the other end of the culvert shall be covered and secured. The center is covered last.
- Backfill material shall be tamped and compacted throughout the entire process.
  - Base and side wall material will be compacted before the pipe is placed in its bed.
  - Backfill compacting will be done in 5 - 1 foot lifts until 1/3 of the diameter of the culvert has been covered. A gas powered tamper can be used for this purpose.
- Inlets and outlets shall be armored with rock or mulched and seeded with grass as needed.
1. Trash protectors shall be installed just upstream from the culvert where there is a hazard of floating debris plugging the culvert.
11. Layers of fill will be pushed over the crossing until the final designed road grade is achieved, at a minimum of 1/3 to 1/2 the culvert diameter.

Note

Road upgrading tasks typically include upgrading stream crossings by installing larger culverts and inlet protection trash carriers to prevent plugging. Culvert sizing for the 100-year peak storm flow should be determined by both field observation and calculations using a procedure such as the Rational Formula.

## Armoring fill faces

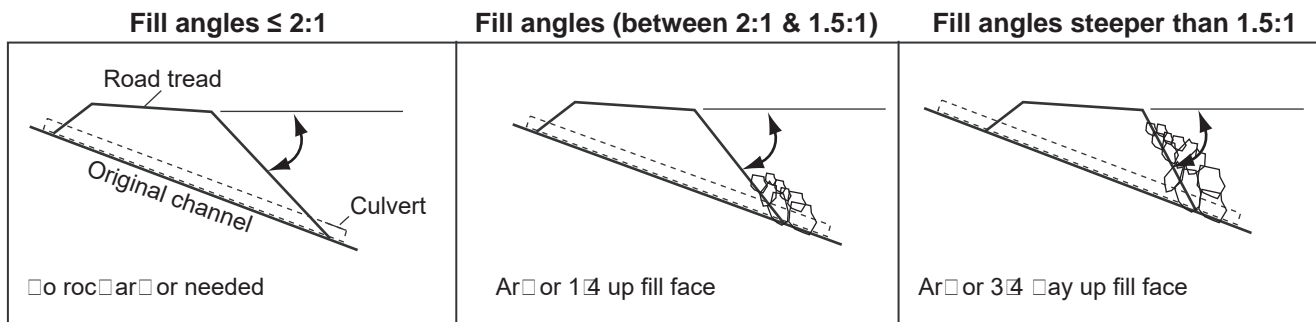

Pacific Watershed Associates Inc.

Geologic and Geomorphic Studies • Watershed Restoration • Wildland Hydrology • Erosion Control • Environmental Services  
 PO Box 4433, Arcata, CA 95518 / Ph: 707-839-5130 / FAX: 707-839-8168 / www.pacificwatershed.com

PWA Typical Drawing #4

Figure 5C - Culvert Specifications

# Typical Dimensions Referred to for Armored Fill Crossings

## Widths in oblique view

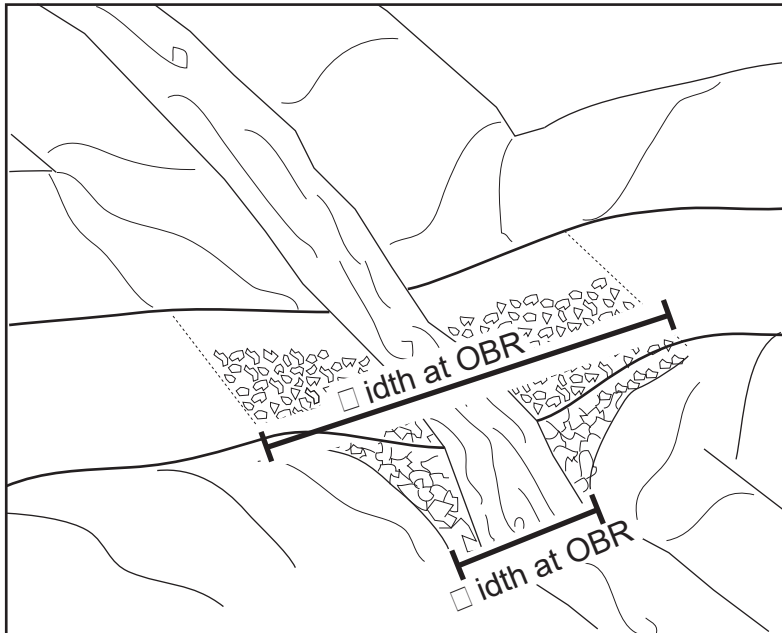

OBR - Outboard edge of road

## Lengths in profile view

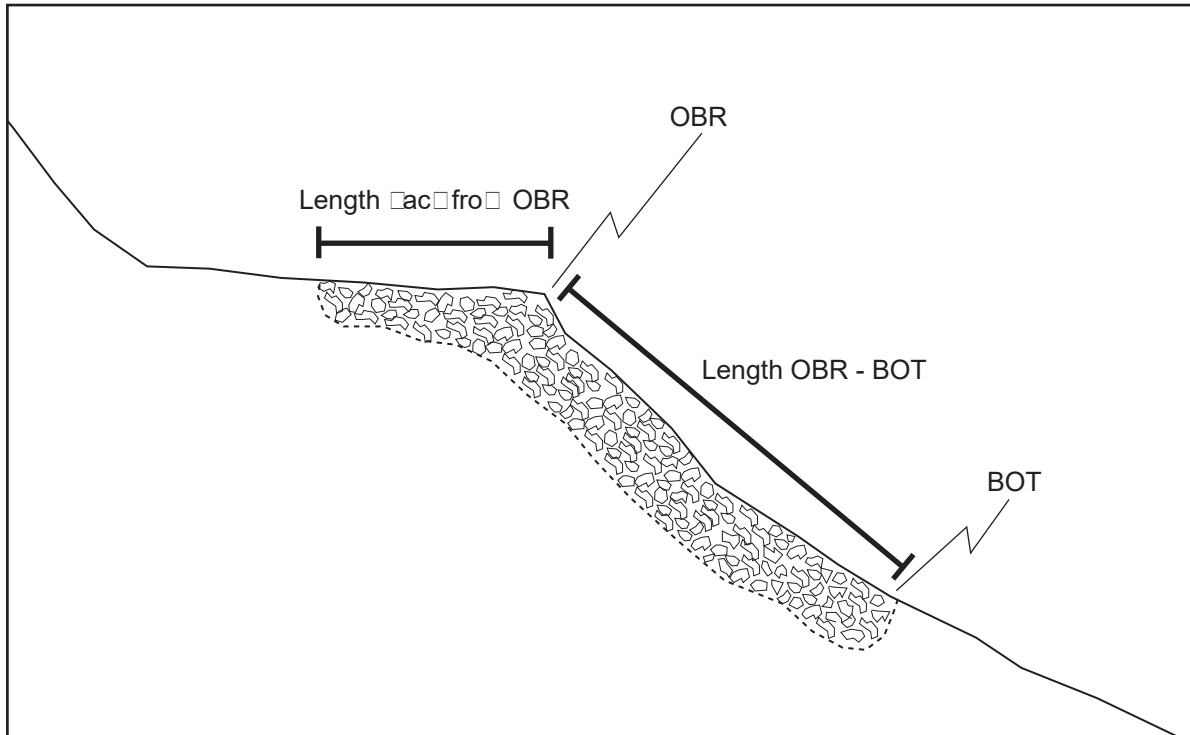

Pacific Watershed Associates Inc.

Geologic and Geomorphic Studies • Watershed Restoration • Wildland Hydrology • Erosion Control • Environmental Services

PO Box 4433, Arcata, CA 95518 / Ph: 707-839-5130 / FAX: 707-839-8168 / www.pacificwatershed.com

Figure 5D - Culvert Specifications

# Typical Armored Fill Crossing Installation

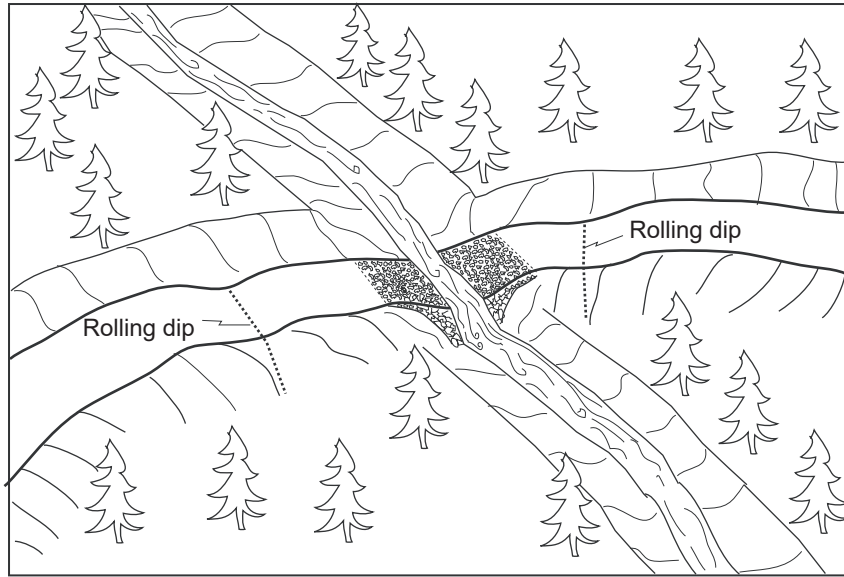

## Cross section parallel to watercourse

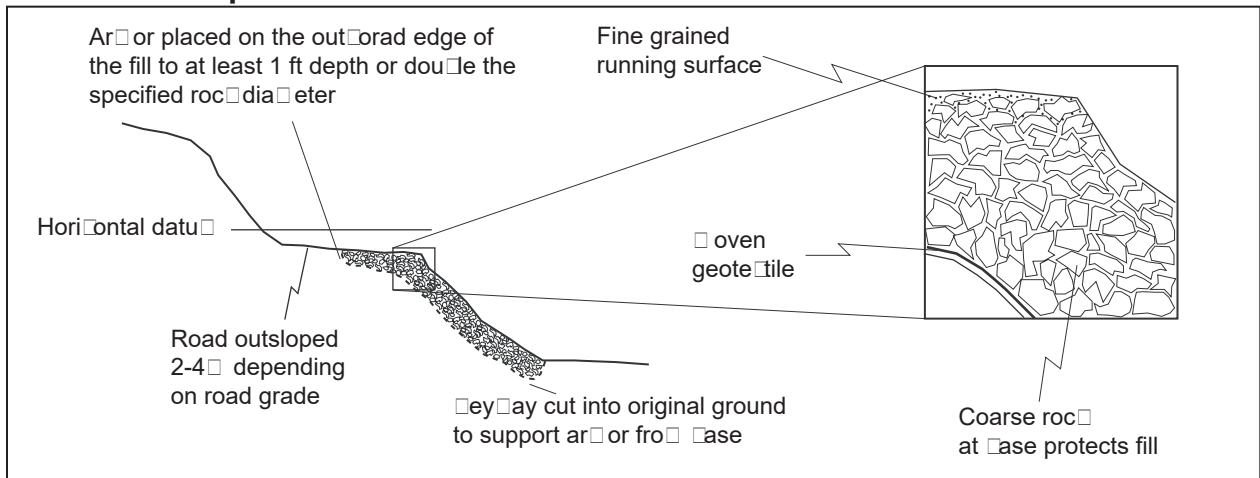

## Cross section perpendicular to watercourse

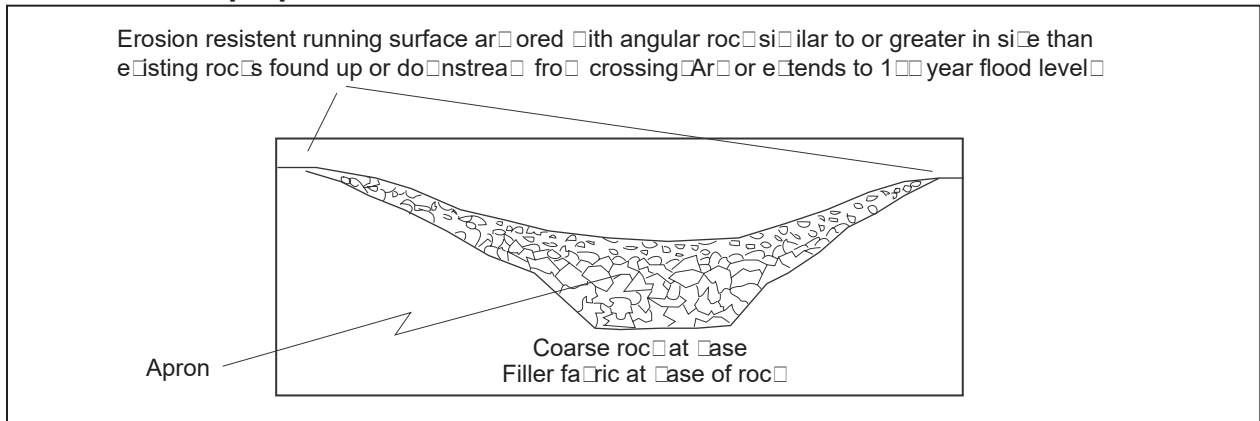

Pacific Watershed Associates Inc.

Geologic and Geomorphic Studies • Watershed Restoration • Wildland Hydrology • Erosion Control • Environmental Services  
 PO Box 4433, Arcata, CA 95518 / Ph: 707-839-5130 / FAX: 707-839-8168 / www.pacificwatershed.com

Figure 5E - Culvert Specifications



# Ten Steps for Constructing a Typical Armored Fill Stream Crossing

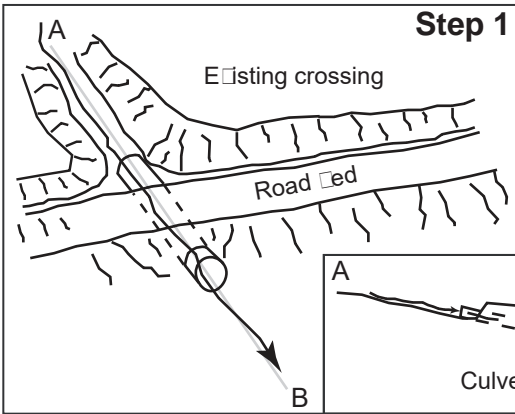

## Step 1

- The two most important points are:
  - A** The rock must be placed in a "U" shape across the channel to confine flow within the armored area. Flooding around the rock armor or will gully the remaining fill. Proper shape of surrounding road fill and good rock placement will reduce the likelihood of crossing failure.
  - B** The largest rocks must be used to buttress the rest of the armor in two locations:
    - The base of the armored fill where the fill meets natural channel. This will buttress the armor placed on the outward fill face and reduce the likelihood of it washing down slope.
    - The area in slope from the road tread to the outer fill face. This will buttress the fill placed on the outer road tread and will determine the base level of the creek as it crosses the road surface.

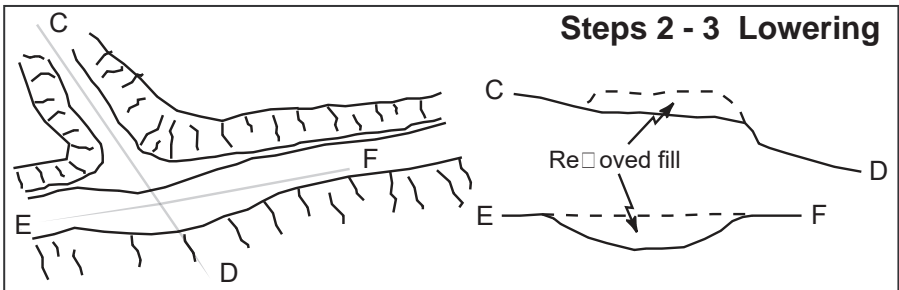

## Steps 2 - 3 Lowering

- Remove any existing drainage structures including culverts and household logs.
- Construct a dip centered at the crossing that is large enough to accommodate the 1-year flood event and prevent diversion (C-D, E-F).

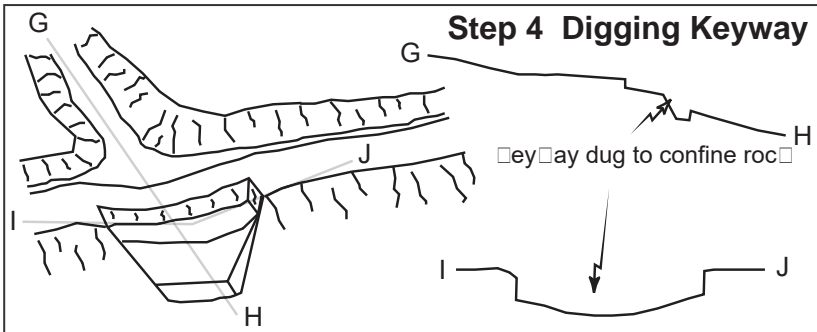

## Step 4 Digging Keyway

- Dig a keyway to place rock in that extends from the outer 1/3 of the road tread down the outward road fill to the point where outward fill meets natural channel up to 3 feet into the channel bed depending on site specifics (G-H, I-J).
- Install geofabric (optional) within keyway to support rock in wet areas and to prevent pinning of the crossing at low flows.

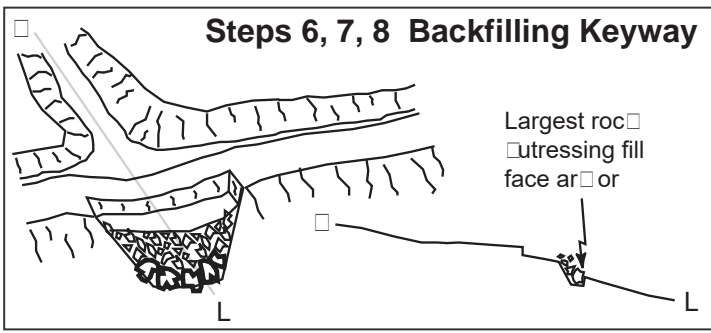

## Steps 6, 7, 8 Backfilling Keyway

- Put aside the largest rock armor to create 2 buttresses in the next step.
- Create a buttress using the largest rock as described in the site treatment specifications at the base of fill. This should have a U-shape to it and will define the outlet of the armored fill.
- Backfill the fill face with remaining rock armor or making sure the final armored area has a U-shape that will accommodate the largest expected flow (M-L).

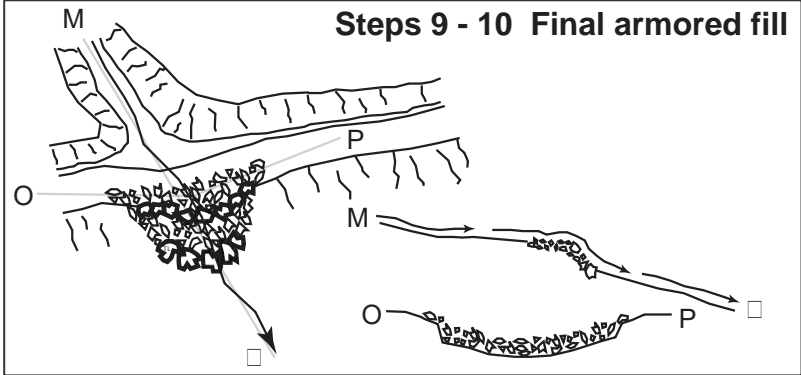

## Steps 9 - 10 Final armored fill

- Install a second buttress at the area in slope between the outward road and the outward fill face. This should define the base level of the stream and determine how deep the stream will backfill after construction (M-N).
- Back fill the rest of the keyway with the unsorted rock armor or making sure the final armored area has a U-shape that will accommodate the largest expected flow (O-P).

Figure 5F - Culvert Specifications

## Typical Ditch Relief Culvert Installation

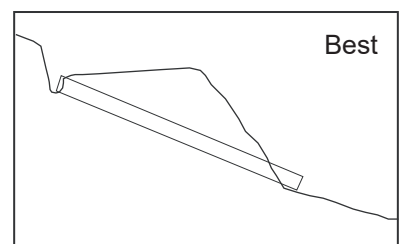
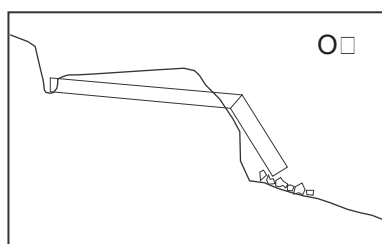
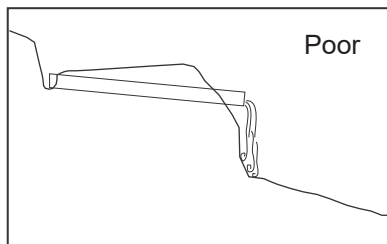
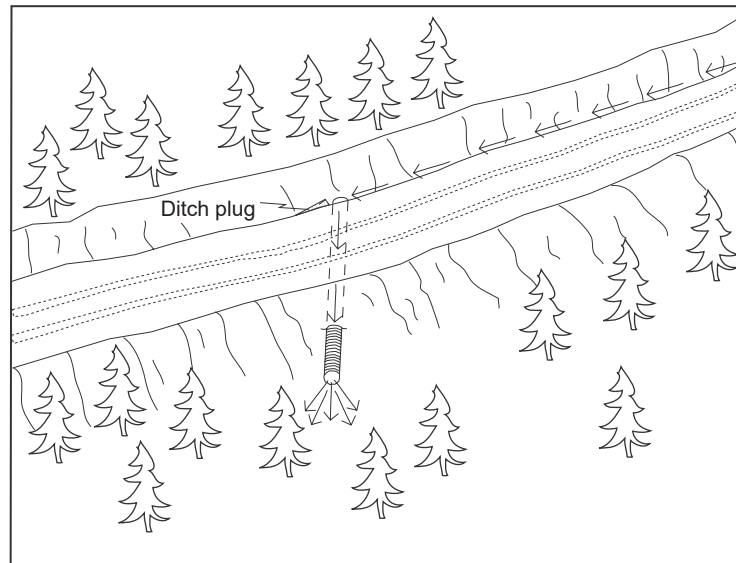

### Ditch relief culvert installation

- 1 The same basic steps followed for stream crossing installation shall be employed
- 2 Culverts shall be installed at a 3 degree angle to the ditch to lessen the chance of inlet erosion and plugging
- 3 Culverts shall be seated on the natural slope or at a minimum depth of 5 feet at the outside edge of the road, whichever is less
- 4 At a minimum, culverts shall be installed at a slope of 2 to 4 percent steeper than the approaching ditch grade, or at least 5 inches every 1 foot
- 5 Backfill shall be compacted from the end to a depth of 1 foot or 1/3 of the culvert diameter, whichever ever is greater, over the top of the culvert
- 6 Culvert outlets shall extend beyond the base of the road fill or a flume discharge will be used
- 7 Culverts will be seated on the natural slope or at a depth of 5 feet at the outside edge of the road, whichever is less

Pacific Watershed Associates Inc.

Geologic and Geomorphic Studies • Watershed Restoration • Wildland Hydrology • Erosion Control • Environmental Services  
PO Box 4433, Arcata, CA 95518 / Ph: 707-839-5130 / FAX: 707-839-8168 / www.pacificwatershed.com

Typical Drawing #8

Figure 5G - Culvert Specifications

# Typical Designs for Using Road Shape to Control Road Runoff

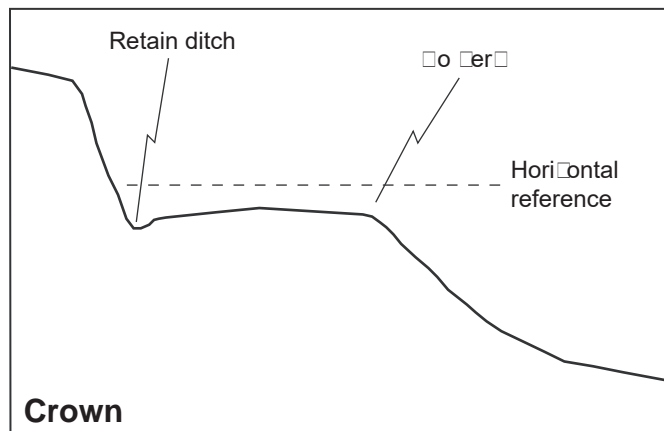
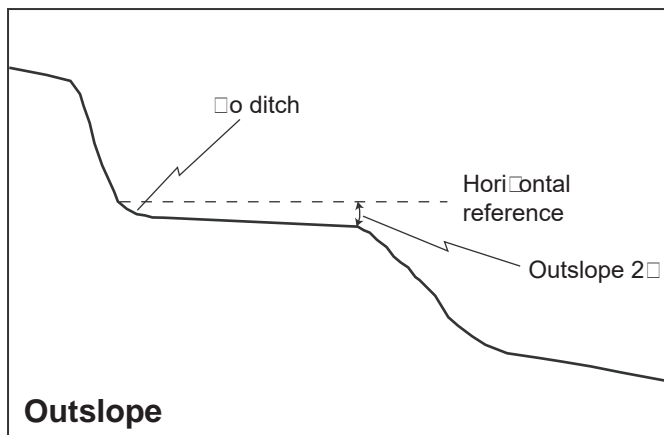
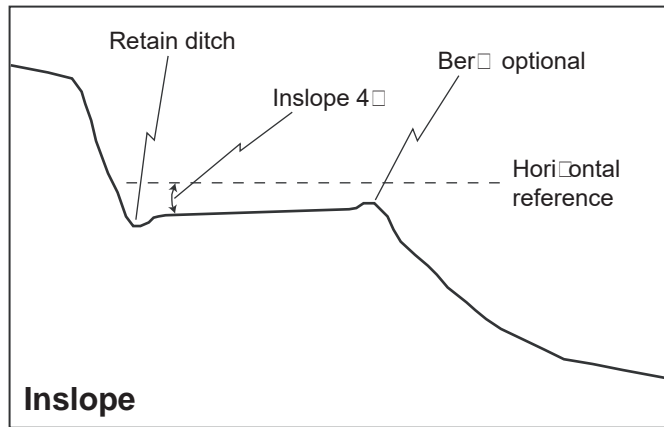

| Outsloping Pitch for Roads Up to 8% Grade |                  |                 |
|---|------------------|-----------------|
| Road grade                                | Unsurfaced roads | Surfaced roads  |
| 4% or less                                | 3/4" per foot    | 1/2" per foot   |
| 5%  | 1 1/2" per foot  | 5/8" per foot   |
| 6%  | 5/8" per foot    | 3/4" per foot   |
| 7%  | 3/4" per foot    | 1/2" per foot   |
| 8% or more                                | 1" per foot      | 1 1/4" per foot |

Pacific Watershed Associates Inc.

Geologic and Geomorphic Studies • Watershed Restoration • Wildland Hydrology • Erosion Control • Environmental Services  
 PO Box 4433, Arcata, CA 95518 / Ph: 707-839-5130 / FAX: 707-839-8168 / www.pacificwatershed.com

Typical Drawing #9

Figure 5H - Culvert Specifications

# Typical Methods for Dispersing Road Surface Runoff with Waterbars, Cross-road Drains, and Rolling Dips

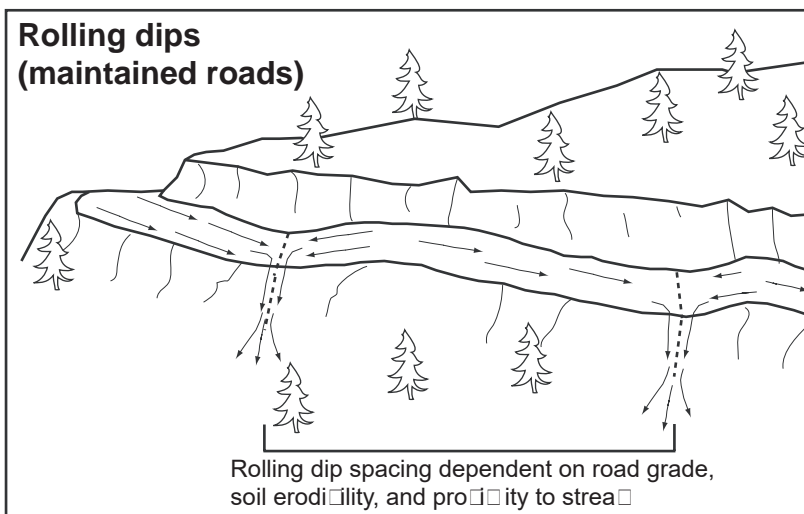
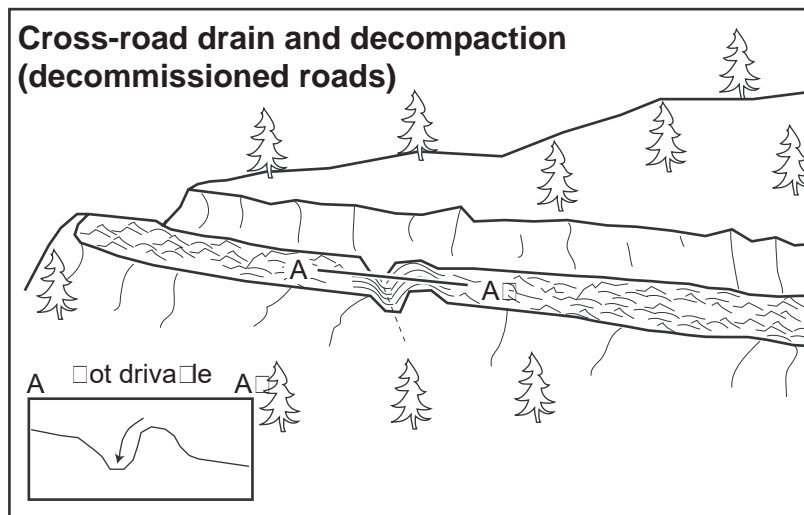
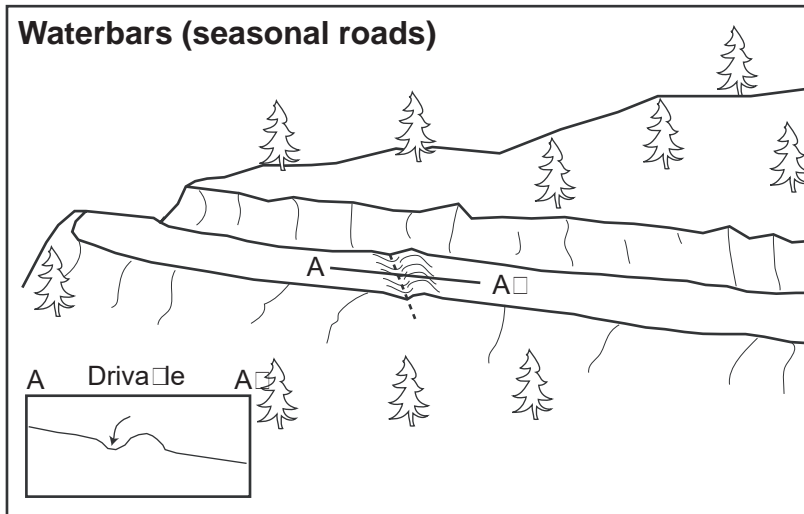

Pacific Watershed Associates Inc.

Geologic and Geomorphic Studies • Watershed Restoration • Wildland Hydrology • Erosion Control • Environmental Services  
 PO Box 4433, Arcata, CA 95518 / Ph: 707-839-5130 / FAX: 707-839-8168 / www.pacificwatershed.com

Typical Drawing #10

Figure 5l - Culvert Specifications

## Typical Road Surface Drainage by Rolling Dips

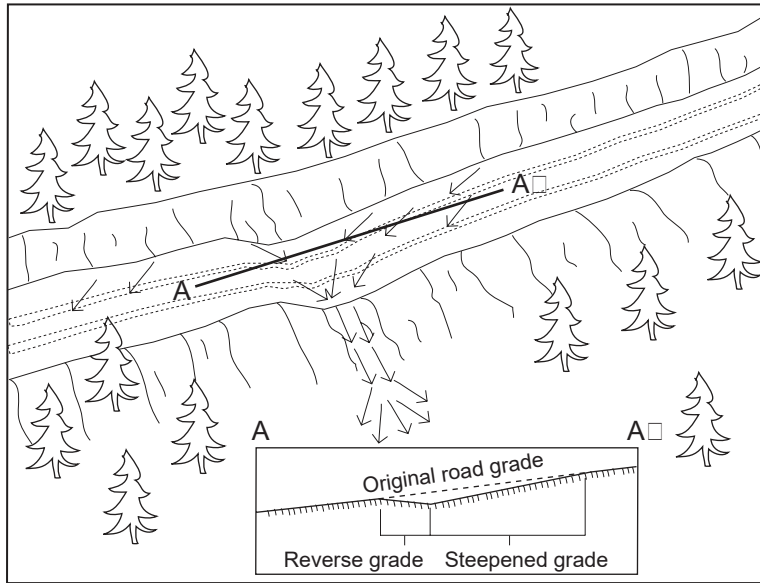

### Rolling dip installation:

- 1 Rolling dips will be installed in the roadbed as needed to drain the road surface
- 2 Rolling dips will be sloped either into the ditch or to the outside of the road edge as required to properly drain the road
- 3 Rolling dips are usually built at 3 to 45 degree angles to the road alignment with cross road grade of at least 1% greater than the grade of the road
- 4 Excavation for the dips will be done with a medium-size bulldozer or similar equipment
- 5 Excavation of the dips will begin 5 to 10 feet up road from where the axis of the dip is planned as per guidelines established in the rolling dip dimensions table
  - Material will be progressively excavated from the roadbed, steepening the grade until the axis is reached
  - The depth of the dip will be determined by the grade of the road (see table below)
  - On the down road side of the rolling dip axis, a grade change will be installed to prevent the runoff from continuing down the road (see figure above)
  - The rise in the reverse grade will be carried for about 10 to 20 feet and then return to the original slope
- 6 The transition from axis to bottom, through rising grade to falling grade, will be in a road distance of at least 15 to 30 feet

**Table of rolling dip dimensions by road grade**

| Road grade<br>% | Upslope approach<br>distance<br>from up road start to<br>trough ft | Reverse grade<br>distance<br>from trough to crest ft | Depth at trough outlet<br>below average road<br>grade ft | Depth at trough inlet<br>below average road<br>grade ft |
|-----------------|--|--|--|---|
| 0               | 55   | 15 - 20  | 0  | 3   |
| 5               | 5  | 15 - 20  | 1  | 2   |
| 10              | 5  | 15 - 20  | 1  | 1   |
| 12              | 5  | 20 - 25  | 1  | 1   |
| 12              | 10   | 20 - 25  | 1  | 1   |

**Pacific Watershed Associates Inc.**

Geologic and Geomorphic Studies • Watershed Restoration • Wildland Hydrology • Erosion Control • Environmental Services  
PO Box 4433, Arcata, CA 95518 / Ph: 707-839-5130 / FAX: 707-839-8168 / www.pacificwatershed.com

**From:** [Jessica](#)  
**To:** [Adler, Elanah](#); [Richardson, Michael](#); [Margro Advisors](#)  
**Subject:** Wesley Stoft - Mitigation and Remediation Grant Fund Proposal  
**Date:** Friday, October 29, 2021 1:24:05 PM  
**Attachments:** [Mitigation Fund Application - Walker Ridge Stoft.pdf](#)  
[Stoft Grant Maps Figures.pdf](#)

---

Dear Michael and Elanah,

I am pleased to present the attached grant proposal on behalf of Wesley Stoft, Walker Ridge Family Farm, LLC.

Please feel free to reach out to me with questions or comments.

Thank you,

Jessica

--

Jessica  
Project Manager  
Margro Advisors

1-707-500-2420