

6. Diamond Sky Farm Grant Application

DIAMOND SKY FARM

(831)818-9928
propgirlsheltercove@gmail.com

PO box 616
Whitethorn,CA
95589

October 26, 2021

Moriah Appel
Diamond sky farm
7050 Crooked Prairie Road
Redway , CA 95560

Dear Michael,

My name is Moriah Appel. My property is located at 7050 Crooked Prairie Road, APN 221-221-009, in the Briceland area of Southern Humboldt. I am seeking financial assistance with remediation plan, erosion control related to my driveway that enters from Crooked Prairie Road. The driveway is approximately .2 miles long. The remediation will be to reshape the driveway and eliminate the inboard ditch. The driveway will be out sloped at 3%-5% and placement of 2 rolling dips will hydrologically disconnect driveway runoff into the nearby watercourse. At completion of the reshaping of the driveway, 1 1/2" road base at a depth of 4" will be placed.

The project is limited to two encroachments (Table 1). One encroachment is to upgrade a misaligned and undersized culvert. Work for this encroachment will include excavation, removal of the undersized/misaligned Culver, replacement with a new properly sized and placed culvert, backfilling and compaction of fill, a rock armoring as necessary to minimize erosion. One encroachment is to remove a culvert road stream crossing and install an armored fill crossing. Work for the encroachment includes excavation, removal of the existing culvert, recontouring, and rock armoring as necessary to minimize erosion.

Two contractors have been out to do a site visit. Currently I am still waiting to get those quotes in writing. Verbally they have quoted the work at \$22,000-\$25,000 to complete all necessary steps to minimize erosion. Work will be done in dry season starting April 15, 2022 and completed by October 15, 2022.

Project Trellis has provided a grant for \$10,000. I am seeking \$15,000 to complete this project.

Thank You for your consideration

Sincerely, Moriah Appel

APPLICATION PACKET CHECKLIST

Please check below to ensure you have a complete application. Once complete, email the following documents, in pdf format with the text "Application for Remediation Grant Program Funding" in the subject line to mrichardson@co.humboldt.ca.us.

- Signed Application Submission Form
- Project Description – Summary of the Project, up to 2 pages.
- Plot Plan
- Plot Plan Checklist – Attached
- Cross sections of proposed work including topographic elevations
- Scope of Work – Detailed Description of Work
- Schedule for Completion – Identify Milestones
- Erosion Control Plan and Monitoring Plan
- Budget – Be as specific as possible – sample attached
- Project Maps and Figures
- Letter(s) of Support (optional)

APPLICATION FORM - Commercial Cannabis Land Use Ordinance Mitigation and Remediation Fund Program

Project Title: DIAMOND SKY FARM

Date of Application: 10.26.21

Applicant Name: Mariah Appel

Project APN: 221-221-009

Contact Person Name and Title: Mariah Appel

Contact Phone: (531) 818-9928 Contact Email: propgidshelter.cove@gmail

Contact Address: P.O. Box 616 Whitethorn CA. 95589

Amount Requested: \$15,000

Total Budget: \$25,000

Project Timeline: Start Date: 4.15.22

End Date: 10.15.22

Signature of Applicant: Mariah Appel

Sample Schedule for Completion

Milestone	Start Date	End Date
Detailed Project Scoping	4/10/20	
Bidding and Contracting	11/1/21	
Project Ground-Breaking	4/15/22	
Inspections by _____		
Project Completion	10/15/22	
Monitoring		

Sample Budget

Budget Item	Grant	Other Funds
Permit Fees (specify)		
Consultant and professional fees		
Materials		
Equipment		
Other (specify)		
TOTAL		

Note: 80% of program funds are required to be spent on physical improvements.

SITE PLAN

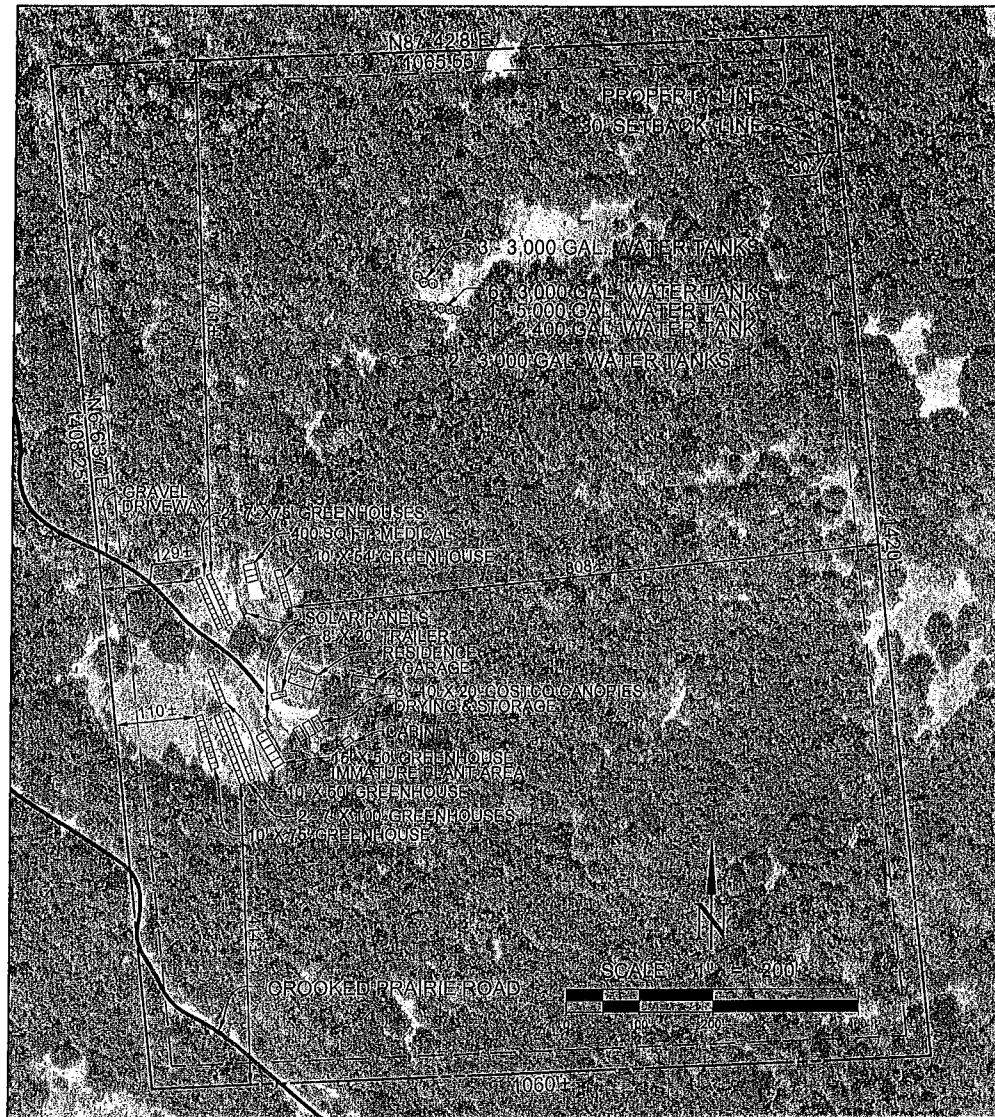

PROJECT INFORMATION:

Applicant: Moriah Appel

Site Address:
7050 Crooked Prairie Road
Whitethorn, CA 95589
APN: 221-221-009-000

Land Owner:
Moriah Appel
PO Box 616
Whitethorn, CA 95589

Agent:
Clearwater Ag Services
446 Maple Lane
Garberville, CA 95542

Trees to be Removed: none
Outdoor Cultivation Area: 4240 Sq.Ft.
Immature Plant Area: 750 Sq.Ft.
Earthwork Quantities: none
Water: Rainwater Catchment
Sewer: Portable Toilet
Power: Solar
Parcel Size: 38.74
Zoning: U
General Plan Designation: RA40

GENERAL NOTES:

1. DRAWING SCALE AS NOTED. WRITTEN DIMENSIONS SHALL TAKE PRECEDENCE OVER SCALED DIMENSIONS.
2. THIS IS NOT A BOUNDARY SURVEY. BOUNDARY INFORMATION DEPICTED HAS BEEN OBTAINED FROM HUMBOLDT COUNTY 2015 GIS DATA. APPLICANT HAS NOT VERIFIED THIS PROPERTY BOUNDARY.
3. THERE ARE NO NEARBY SCHOOLS, SCHOOL BUS STOPS, PLACES OF WORSHIP, PUBLIC PARKS OR TRIBAL RESOURCES WITHIN 600 FEET OF THE CULTIVATION AREA.
4. THERE ARE NO RESIDENCES ON ADJOINING PARCELS WITHIN 300 FEET OF THE CULTIVATION AREAS.
5. ANY EXISTING DEVELOPMENT CONSTRUCTED WITHOUT THE BENEFIT OF COUNTY REVIEW WILL BE SUBJECT TO THE HUMBOLDT COUNTY BUILDING DEPARTMENT UPON APPROVAL OF THE ZONING CLEARANCE CERTIFICATE.

DIRECTIONS TO SITE:

From Highway 101, Take Exit 642 for Redway/Redwood Drive
Continue 2 miles, turn right onto Briceland Road.
Continue 7.2 miles to Blue Slide Creek Road, on right.
Continue 4.5 miles to Crooked Prairie Road, on right
Project site driveway is .1 mile down Crooked Prairie Road



707-923-2767

This map is provided without warranty on any kind. Spatial data is approximate. Parcel positions are estimates only. Reasonable effort has been made to ensure the accuracy of the map and data provided, however errors and omissions may still exist. The positional accuracy of the data is approximate and is not intended to represent surveyed information. Do not use this map to determine property boundaries.

10/21/21

Site Management Plan



Moriah Appel
APN 221-221-009

Site Management Plan

Introduction

This Site Management Plan was prepared to fulfill the requirements of the State Water Resources Control Board order WQ 2019-0001-DWQ. The order requires Tier 1 and Tier 2 cannabis cultivators to submit and implement a Site Management Plan and submit it to the Water Board within 90 days of Notice of Receipt, describing how the Discharger is complying with the BPTC measures listed in Attachment A. Dischargers that are landowners of the cultivation site in North Coast Regional Water Board jurisdiction are required to submit and implement Site Management Plans that describes how the BPTC measures are implemented Property-wide, including BPTC measures implemented to address dischargers from legacy activities. The Site Management Plan may include a schedule to achieve compliance, but all work must be completed by the onset of winter period each year.

The following resources were consulted in the preparation of this plan:

State Water Resources Control Board Order WQ 2019-0001-DWQ General Waste Discharge Requirements and Waiver of Waste Discharge Requirements for Discharges of Waste Associated with Cannabis Cultivation Activities, Attachment A, Definitions and Requirements for Cannabis Cultivation.

Handbook for Forest Ranch and Rural Roads, A Guide for Planning, Designing, Constructing, Reconstructing, Upgrading, Maintaining, and Closing Wildland Roads. Prepared by William Weaver, PhD Eileen Weppner, P.G. Danny Hagans, CPESC Pacific Watershed Associates, Ca.

1. Sediment Discharge BPTC Measures

Site Information

Applicant: Mariah Appel

Owner: Moriah Appel

Address: 7050 Crooked Prairie Road

PO Box 616

Whitethorn Ca. 95589

APN 221-221-009

County: Humboldt

Zoning: U

Field Visit: 12/22/2019 1500

1.1 Site Characteristics

This parcel is located at 7050 Crooked Prairie Road in the Briceland area of Southern Humboldt County. The parcel is accessed by a gravel driveway off of Crooked Prairie Road. The driveway is approximately .2 miles long. The parcel is a western aspect with a residence and several outbuildings all in good condition. Elevation ranges from 800' to 1360'. The parcel is 38.74 acres. Slopes of the parcel range from 5% to 40% as it slopes toward the West Southwest. Vegetation varies from mixed oak woodland with brush and alder along the riparian buffer. The driveway and parking areas are all graveled.

Prior to our site visit, aerial photos USGS topo maps were examined for water courses, developed sites, roads and driveways, slope instabilities and erosional features such as gullies and slides.

The property is served by a rain catchment system which catches rain from the rain gutters of the residence and pipes it to rigid plastic holding tanks. Total water storage is approx. 90,000 gallons in 33 separate rigid plastic tanks of various sizes.

The outdoor cultivation sites are in two locations and total 4,260 sq ft of cannabis cultivation. The first is an area of historic cultivation with existing garden beds. This area also has vegetable garden area, fruit trees, ornamental trees and chicken pen. The wood framed garden beds are covered during the winter with plastic tarps. This helps to eliminate potential run off from the cannabis garden during rainy season. The area is a small flat.

The second cultivation area is below the residence. Slopes are less approximately 30% at this location. Small terraces are used for the cultivation areas. A natural vegetation buffer exists between all cultivation and any nearby watercourses.

1.1.1

Maps. See attached documents.

1.1.2 Access Road Conditions

Access road is an existing gravel road which is approximately 4.5 miles from the County maintained Briceland Thorn Road. Road assessment revealed proper design and function with some erosion present during site visit. This erosion can be mitigated by maintenance practices. Slopes of the driveway is from 5% to up to 20%. Estimated vehicle traffic is 1-2 cars per day and no increase of traffic is expected due to the cannabis cultivation project. Property owner addresses any discharge issues during rainy season by monitoring the road and associated 18" existing culvert which there is one. There were signs of some erosion and sediment discharge observed on our site visit. To address these issues a road design and maintenance plan will be provided in this document.

1.1.3 Vehicle Crossings

There is one 18" steel culvert located on the driveway in a class 3 water course near the gate at the entrance of the property. This culvert appears to be functioning correctly and meets the 100 year flood event calculations. It is recommended to place 6 cu yds. of rip-rap at the outlet of the culvert to dissipate water flow and reduce erosion. Removal of debris and maintenance of the inlet is required for optimum performance of the culvert.

An additional 18" culvert is to be removed from what is a non-water course. The treatment will be a rock armor crossing.

1.1.3.1 Legacy Discharge

No legacy waste discharge issues were located on this parcel.

1.2 Sediment Erosion Prevention and Sediment Capture

The property was inspected for indications of instability including weak soil layers, geologic bedding parallel to slope surface, bulging soil at the base of slope, and groundwater discharge from slope. No unstable areas were located on the property. Applicant will perform monthly inspections for signs of instability throughout the winter period and after any significant storm event. In the case the site becomes unstable, a qualified professional will be contracted to stabilize the area. Unstable sites will be monitored after any significant rain fall event and before the onset of the winter period to ensure that these areas remain stable and do not lead to discharge to nearby watercourses. Storm water runoff from the cultivation areas remains dispersed and does not runoff into any nearby watercourse.

1.2.1 Erosion Prevention BPTC Measures

Cover crops or tarps are used to cover cultivation beds during the rainy season to prevent soil or nutrient runoff due to rainfall. Plant waste and soil waste are to be stored in different contained piles. At this time Applicant does not generate soil waste as all the soil is reconditioned with natural nutrients for continued use. A compost pile is fully contained near the garden area. This compost will be used for future garden compost.

Slopes adjacent to the cultivation areas have established natural vegetation that prevents erosion and prevents exposure of soils to rainfall.

After any land disturbance activities, weed free straw will be applied at a rate of two tons per acre of exposed soil and if warranted by conditions will be secured to the ground by the use of jute cloth. These stabilization measures will be implemented within seven days of any land disturbance activity.

1.2.2 Sediment Control BPTC Measures

The cultivation areas remain hydrologically disconnected from any nearby watercourses. The small footprint of the cultivation areas generates a minimal amount of runoff which is disbursed into the natural vegetation. Sediment capture measures will be implemented as part of the

winterization procedure for any disturbed sites including measures such as check dams, fiber rolls, straw bale barriers, properly installed silt fences and sediment settling basins or bio-swales.

1.2.3 Maintenance Activities

Moriah Appel will perform self-inspections of all facilities, erosion control and sediment control BPTC measures at the beginning of the grow season and following any significant rainfall event (see Facility Status Self Survey). She will also inspect the site and implement any applicable BPTC measures before the onset of the winter period (see Winterization Checklist).

Monitoring of the site includes visual inspection and photographic documentation of each feature of interest listed on the site map, with new photographic documentation with any notable changes to the feature of interest. At a minimum, all site features must be monitored annually.

Additionally, sites shall be monitored at the following times to ensure timely identification of changed site conditions and to determine whether implementation of additional management measures are necessary to prevent, minimize and mitigate discharges of waste to surface water: Prior to October 15th to evaluate site preparedness for storm events and storm water runoff, Following any rainfall event with an intensity of 3" in 24 hours. Precipitation data can be obtained from the National Weather Service Forecast Office (by entering the zip code of the parcel location at <http://www.srh.noaa.gov/forecast>).

2. Fertilizer, Pesticide, Herbicide and Rodenticide BPTC Measures

Moriah Appel uses permaculture techniques which greatly reduce the need for soil additives. Nutrients are stored inside and existing garden shed with secondary containment. At the time of inspection, soil additives and nutrients were stored appropriately.

Fertilizers will be stored for long term storage inside the shed with secondary containment as well. This will eliminate the possible exposure to the elements and potential runoff to the nearby water sheds.

The garden shed provides cover from rain and the elements and is secure from wildlife.

Moriah Appel applies nutrients at or below agronomic rates. They do not use any registered pesticides, fungicides or rodenticides on this property. As part of the permaculture techniques, companion planting and other integrated pest management. See attachment for specific Fertilizers and Nutrients used.

2.2 Site Map

Storage areas of nutrient and fertilizers are identified on site map as Garden Shed.

2.3 Bulk Fertilizer and Chemical Storage

See site plan.

2.4 Spill Prevention and Clean Up Procedures

Spill kits will be kept on site with absorbent materials, proper personal protective equipment and proper disposal containers. Storage and handling will be done with extreme care to prevent any spills or discharges. Adequate secondary containment will be provided where necessary.

All mandatory action will be taken in accordance with the Cal OES Hazardous Materials Spill/Release Notification Guide. If the source of the spill can be safely shut off, personnel will attempt to do so. If the spill or discharge can be safely cleaned up by the facility owner using the available spill supplies, they will do so. The Owner/Operator will determine if the spill/discharge poses a threat to health, safety, property and or the environment and will immediately notify the necessary agencies. If the spill/discharge threatens to leave the property, personnel will attempt to place sorbents in the path, if it can be done safely. The facility personnel's Hazardous Waste Contractor will be contacted in a cleanup if necessary. All collected spill residues will be properly disposed as a hazardous waste.

3. Petroleum Product BPTC Measures

There are no petroleum products used as part of this cultivation project. Owners use gasoline powered weed-eater, lawn mowers and other small hand tools for gardening. Small gasoline engine fuel is stored in approved 5-gallon containers in the garage.

4. Trash/Refuse and domestic wastewater BPTC Measures

Refuse will be cleared and disposed of off site to prevent contamination of the environment and access by wildlife. Trash/Refuse will be stored in appropriate containers and regularly hauled to the Eel River Resource Recovery Center in Redway Ca. on a bi-monthly basis.

4.1 Trash/Refuse Containment and Disposal

All Trash/Refuse generated will be kept covered to mitigate potential discharge and access by wildlife. The use of covered trash cans in a contained area will help to eliminate the possible contamination of the property of any type of trash. All Trash/Refuse will be hauled to a proper treatment facility.

4.1.1 Site Map

See site map for location of Solid Waste Storage Area.

4.2 Employees, Visitors or Residents

This project requires no employees. There are no visitors to the site on a regular basis. The home on the parcel is the full-time residence of the owners.

4.2.2 Disposal of Domestic Waste Water

The residence has an unpermitted waste water treatment septic system. There will be no additional effluents associated with this cannabis cultivation project, therefore the existing septic system is adequate for this parcel. A porta potti will be rented and maintained from a local vendor for use during the growing season until a permitted septic system can be installed.

5. Winterization BPTC Measures

5.1 Winterization Actions

Sediment capture measures will be implemented as part of the winterization procedures for all disturbed areas, including the implementation of measures such as check dams, fiber rolls, straw bale barriers, properly installed silt fences, and sediment settling basins as necessary. Culverts and storm drains will be cleared from debris prior to the onset of winter period.

5.2 Maintenance Activities

Culverts and storm drain inlets and outlets will be cleared from debris prior to the onset of the winter period. All drainage or sediment capture features will be monitored and the removal of debris and soil blockages will commence when necessary to ensure the existence of adequate capacity.

5.3 Revegetation Activities

All BPTC measures will be followed and actions will be taken in accordance with best winterization techniques. Any and all exposed soils will be covered with natural vegetation, the garden beds will be cover cropped or tarped when not in use for cultivation.

5.4 Compliance Schedule

If any BPTC measures cannot be completed before the onset of winter, the owner/operator will contact the SWRCB to establish a compliance schedule.

5.5 Steps to Address Legacy Discharge Issues

At the time of inspection there were no legacy discharge issues found.

6. Identified Sites Requiring Remediation

At the time of inspection there were several sites requiring remediation identified. See attached photos and remediation plan.

Remediation Plan for APN 221-221-009

7050 Crooked Prairie Road

Whitethorn, Ca. 95589

CP-1. This is an 18" serviceable CMP. Place 6 cu. Yds of Class 3 Quarry Rip Rap at the outlet of this culvert to dissipate the outflow of water to help eliminate erosion.

CP-2. This 18" CMP is not in a watercourse. Remove this CMP as it is not in a water course and installed improperly. Use 10 cu. Yds of 4" fractured quarry rock to create an armored crossing, extending 10' each side of where the old culvert was removed.

RA-1. Driveway between Crooked Prairie Road and the first switchback has erosion occurring along the inboard ditch. Remediation will be to reshape the driveway and eliminate the inboard ditch. The driveway will be out-sloped at 3%-5% and placement of 2 rolling dips will hydrologically disconnect driveway runoff into the nearby watercourse. At the completion of the reshaping of the driveway, place 1 1/2" road base at a depth of 4".

Winterization Checklist

To be completed before the onset of the winter period.

1. Have all applicable erosion control and soil disposal and spoils management requirements been filled?

Yes No N/A

Comments:

2. Have all seasonal and temporary access roads been blocked or otherwise closed to motor vehicles?

Yes No N/A

Comments:

3. Can you confirm that no heavy equipment of any kind will be operated at the cannabis cultivation site during the winter period, unless authorized for emergency repairs contained in an enforcement order issued by the state water board, regional water board, or other agency having jurisdiction?

Yes No N/A

Comments:

4. Have linear sediment controls been applied (e.g., silt fences, wattles, ect.) along the toe of the slope, and at the grade breaks of exposed slopes to comply with the sheet flow length at the frequency specified below?

Slope (percent)	Sheet Flow Length Not to Exceed (feet)
0 - 25	20
25 - 50	15
>50	10

Yes No N/A

Comments:

Untitled Map

Project Area

Legend

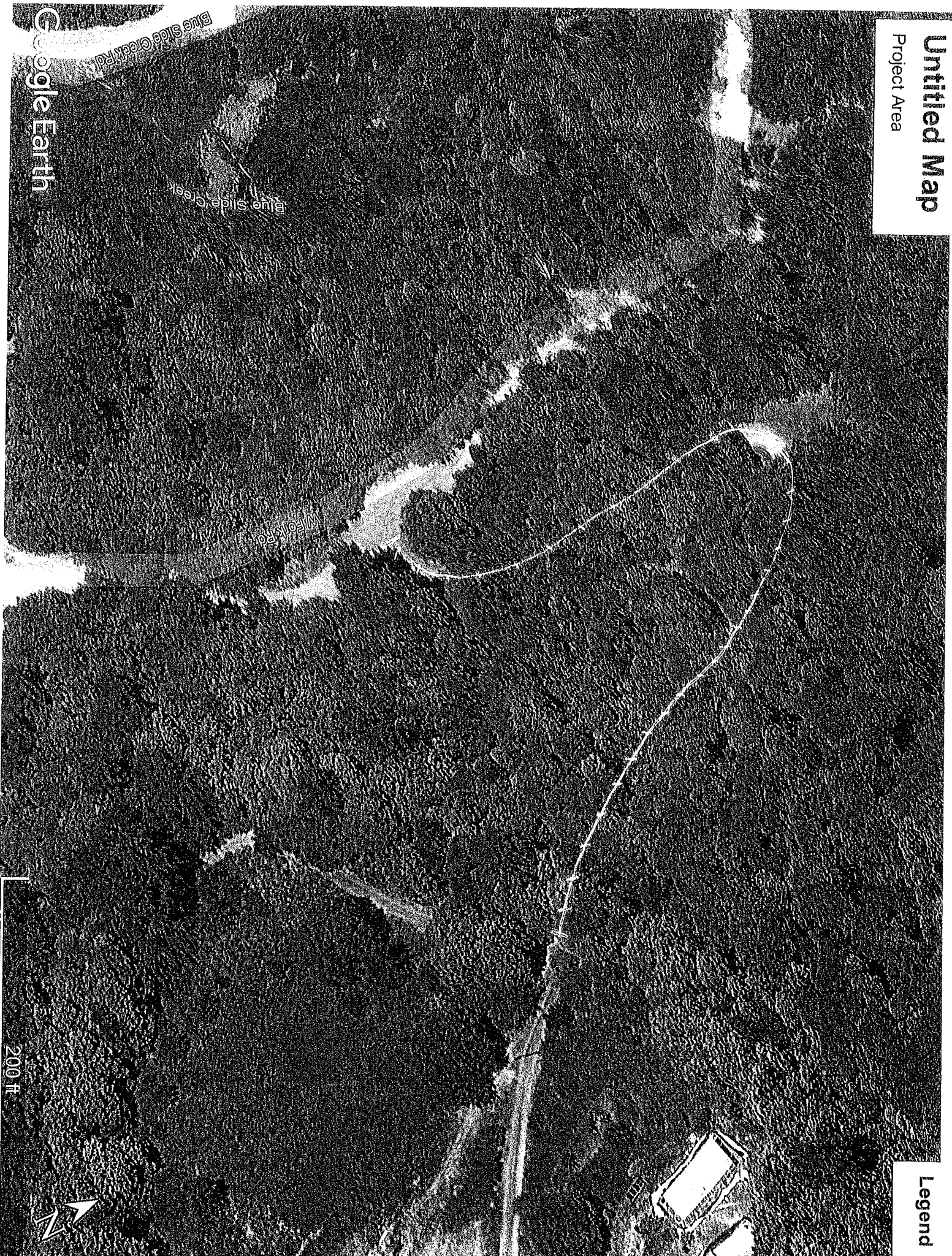

Google Earth

200 ft



CALIFORNIA DEPARTMENT OF FISH AND WILDLIFE
REGION 1 -- NORTHERN REGION
619 2nd Street
Eureka, CA 95501

RECEIVED

JUN 09 2020

CDFW - EUREKA



STREAMBED ALTERATION AGREEMENT

NOTIFICATION NO. 1600-2020-0053-R1

Unnamed Tributaries to Blue Slide Creek, Tributary to the Mattole River
and the Pacific Ocean

Moriah Appel
Appel Stream Crossings Project
2 Encroachments

This Streambed Alteration Agreement (Agreement) is entered into between the California Department of Fish and Wildlife (CDFW) and Moriah Appel (Permittee).

RECITALS

WHEREAS, pursuant to Fish and Game Code (FGC) section 1602, the Permittee initially notified CDFW on February 06, 2020, the Permittee intends to complete the project described herein.

WHEREAS, pursuant to FGC section 1603, CDFW has determined that the project could substantially adversely affect existing fish or wildlife resources and has included measures in the Agreement necessary to protect those resources.

WHEREAS, the Permittee has reviewed the Agreement and accepts its terms and conditions, including the measures to protect fish and wildlife resources.

NOW THEREFORE, the Permittee agrees to complete the project in accordance with the Agreement.

PROJECT LOCATION

The project to be completed is located within the Mattole River watershed, approximately 3.8 miles northwest of the town of Briceland, County of Humboldt, State of California. The project is located in Section 9, T4S, R2E, Humboldt Base and Meridian; in the Briceland U.S. Geological Survey 7.5-minute quadrangle; Assessor's Parcel Number 221-221-009; latitude 40.1343 N and longitude -123.9608 W at the Parcel Centroid.

PROJECT DESCRIPTION

This Agreement relies on the Notification materials and a CDFW site inspection by Environmental Scientist Kalyn Bocast on March 12, 2020.

The project is limited to two encroachments (Table 1). One encroachment is to upgrade a misaligned and undersized culvert. Work for this encroachment will include excavation, removal of the undersized/misaligned culvert, replacement with a new properly sized and placed culvert, backfilling and compaction of fill, and rock armoring as necessary to minimize erosion. One encroachment is to remove a culvert road stream crossing and install an armored fill crossing. Work for this encroachment includes excavation, removal of the existing culvert, recontouring, and rock armoring as necessary to minimize erosion.

Table 1. Project Encroachments with Description

ID	Latitude/Longitude	Description
Crossing-1	40.1344, -123.9626	Replace undersized 18" diameter culvert with minimum 24" diameter by 30' long corrugated metal pipe culvert.
Crossing-2	40.1347, -123.9629	Replace an 18" diameter culvert with a rocked ford.

PROJECT IMPACTS

Existing fish or wildlife resources the project could substantially adversely affect include Coho Salmon (*O. kisutch*), Steelhead Trout (*O. mykiss*), Pacific Lamprey (*Entosphenus tridentatus*), Foothill Yellow-legged Frog (*Rana boylei*), Pacific Giant Salamander (*Dicamptodon tenebrosus*), Southern Torrent Salamander (*Rhyacotriton variegatus*), Red-bellied Newt (*Taricha rivularis*), Northern Red-legged Frog (*Rana aurora*), and amphibians, reptiles, aquatic invertebrates, mammals, birds, and other aquatic and riparian species.

The adverse effects the project could have on the fish or wildlife resources identified above include:

Impacts to water quality:

temporary increase in fine sediment transport;

Impacts to natural flow and effects on habitat structure and process:

direct and/or incidental take;

indirect impacts;

water quality degradation; and

damage to aquatic habitat and function.

MEASURES TO PROTECT FISH AND WILDLIFE RESOURCES

1. Administrative Measures

The Permittee shall meet each administrative requirement described below.

- 1.1 Documentation at Project Site. The Permittee shall make the Agreement, any extensions and amendments to the Agreement, and all related notification

materials and California Environmental Quality Act (CEQA) documents, readily available at the project site at all times and shall be presented to CDFW personnel, or personnel from another state, federal, or local agency upon request.

- 1.2 Providing Agreement to Persons at Project Site. The Permittee shall provide copies of the Agreement and any extensions and amendments to the Agreement to all persons who will be working on the project at the project site on behalf of the Permittee, including but not limited to contractors, subcontractors, inspectors, and monitors.
- 1.3 Adherence to Existing Authorizations. All water diversion facilities that the Permittee owns, operates, or controls shall be operated and maintained in accordance with current law and applicable water rights.
- 1.4 Change of Conditions and Need to Cease Operations. If conditions arise, or change, in such a manner as to be considered deleterious by CDFW to the stream or wildlife, operations shall cease until corrective measures approved by CDFW are taken. This includes new information becoming available that indicates that the bypass flows and diversion rates provided in this agreement are not providing adequate protection to keep aquatic life downstream in good condition or to avoid "take" or "incidental take" of federal or State listed species.
- 1.5 Notification of Conflicting Provisions. The Permittee shall notify CDFW if the Permittee determines or learns that a provision in the Agreement might conflict with a provision imposed on the project by another local, state, or federal agency. In that event, CDFW shall contact the Permittee to resolve any conflict.
- 1.6 Project Site Entry. The Permittee agrees to allow CDFW employees access to any property it owns and/or manages for the purpose of inspecting and/or monitoring the activities covered by this Agreement.
- 1.7 CDFW Notification of Work Initiation and Completion. The Permittee shall contact CDFW within the seven-day period preceding the beginning of work permitted by this Agreement. Information to be disclosed shall include Agreement number, and the anticipated start date. Subsequently, the Permittee shall notify CDFW no later than seven (7) days after the project is fully completed.
- 1.8 Agreement Compliance. The proposed work shall comply with all measures included in this Agreement. **Failure to comply with these measures shall result in suspension or revocation of this Agreement.**

2. Avoidance and Minimization Measures

To avoid or minimize adverse impacts to fish and wildlife resources identified above, the Permittee shall implement each measure listed below.

- 2.1 Permitted Project Activities. Except where otherwise stipulated in this Agreement, all work shall be in accordance with the Permittee Notification received on February 06, 2020, together with all maps, BMP's, photographs, drawings, and other supporting documents submitted with the Notification.
- 2.2 Incidental Take. This Agreement does not allow for the take, or incidental take of any state or federal listed threatened or endangered listed species.

Project Timing

- 2.3 Work Period. All work shall be confined to the period **June 15 through October 15** of each year. Work within the active channel of a stream shall be restricted to periods of **dry weather**. Precipitation forecasts and potential increases in stream flow shall be considered when planning construction activities. Construction activities shall cease, and all necessary erosion control measures shall be implemented prior to the onset of precipitation.
- 2.4 Work Completion. The proposed work shall be completed by no later than **October 15, 2022. Failure to complete work by this date shall result in suspension or revocation of this Agreement.** A notice of completed work, including photographs of each site, shall be submitted to CDFW within seven (7) days of project completion.
- 2.5 Extension of the Work Period. If weather conditions permit, and the Permittee wishes to extend the work period after October 15, a written request shall be made to CDFW at least 5-working days before the proposed work period variance. Written approval (letter or e-mail) for the proposed time extension must be received from CDFW prior to activities continuing past October 15.

Vegetation Management

- 2.6 Minimum Vegetation Removal. No native riparian vegetation shall be removed from the bank of the stream, except where authorized by CDFW. Permittee shall limit the disturbance or removal of native vegetation to the minimum necessary to achieve design guidelines and standards for the Authorized Activity. Permittee shall take precautions to avoid damage to vegetation outside the work area.
- 2.7 Vegetation Management. Permittee shall limit vegetation management (e.g., trimming, pruning, or limbing) and removal for the purpose of stream crossing placement/maintenance to the use of hand tools. Vegetation management shall not include treatment with herbicides.

Water Storage

- 2.8 Water Storage. All water storage facilities (WSFs) (e.g., reservoirs, storage tanks, mix tanks, and bladders tanks) must be located outside the active 100-year

floodplain and outside the top of bank of a stream. Covers/lids shall be securely affixed to water tanks at all times to prevent potential entry by wildlife.

Equipment and Vehicles

- 2.9 **Clean Equipment Prior to Work.** All heavy equipment that will be working within 150 feet of a stream shall be cleaned daily, to remove materials deleterious to aquatic and terrestrial life or riparian habitat including non-native species, oil, grease, hydraulic fluid, soil, and other debris. Cleaning of equipment shall take place a minimum of 150 feet from top of bank or edge of the riparian zone, whichever results in a greater stream buffer.
- 2.10 **Operating Equipment and Vehicle Leaks.** Any equipment or vehicles driven and/or operated within or adjacent to the stream shall be checked and maintained daily to prevent leaks of materials that could be deleterious to aquatic and terrestrial life or riparian habitat.
- 2.11 **Staging and Storage Areas.** Short-term staging and storage areas for equipment, materials, fuels, lubricants, and solvents shall be located more than 150 feet from the top of bank or edge of the riparian zone, whichever results in a greater stream buffer. All equipment and fuel stored on site shall be bermed to contain any spilled material and shall be protected from rain. Berms shall consist of plastic covered dirt or sandbags. All materials shall be promptly removed following the completion of project work.
- 2.12 **Equipment Maintenance.** Refueling of machinery or heavy equipment, or adding or draining oil, lubricants, coolants or hydraulic fluids shall not take place within 150 feet of the stream bed, channel and bank. All such fluids and containers shall be disposed of properly off-site. Heavy equipment used or stored within stream bed, channel and bank shall use drip pans or other devices (e.g., absorbent blankets, sheet barriers or other materials) as needed to prevent soil and water contamination.
- 2.13 **Hazardous Spills.** Any material, which could be hazardous or toxic to aquatic life and enters a stream (i.e. a piece of equipment tipping-over in a stream and dumping oil, fuel or hydraulic fluid), the Permittee shall immediately notify the California Emergency Management Agency State Warning Center at 1-800-852-7550, and immediately initiate clean-up activities. CDFW shall be notified by the Permittee within 24 hours at 707-445-6493 and consulted regarding clean-up procedures.

Stream Crossings

- 2.14 **Stream Protection.** No debris, soil, silt, sand, bark, slash, sawdust, rubbish, cement or concrete washings, oil or petroleum products, or other deleterious material from project activities shall be allowed to enter into or be placed where it

may be washed by rainfall or runoff into the stream. All project materials and debris shall be removed from the project site and properly disposed of off-site upon project completion.

- 2.15 Excavated Fill. Excavated fill material shall be placed in upland locations where it cannot deliver to a watercourse. To minimize the potential for material to enter the watercourse during the winter period, all excavated and relocated fill material shall be tractor contoured (to drain water) and tractor compacted to effectively incorporate and stabilize loose material into existing road and/or landing features.
- 2.16 Runoff from Steep Areas. The Permittee shall make preparations so that runoff from steep, erodible surfaces will be diverted into stable areas with little erosion potential or contained behind erosion control structures. Erosion control structures such as straw bales and/or siltation control fencing shall be placed and maintained until the threat of erosion ceases. Frequent water checks shall be placed on dirt roads, cat tracks, or other work trails to control erosion.
- 2.17 Culvert Installation.
- 2.17.1 The project is located in a moderate to very high Fire Hazard Severity Zone as designated by CAL FIRE. CDFW recommends corrugated metal pipe (CMP) for use in culvert installation and/or replacement.
- 2.17.2 Existing fill material in the crossing shall be excavated down vertically to the approximate original channel and outwards horizontally to the approximate crossing hinge points (transition between naturally occurring soil and remnant temporary crossing fill material) to remove any potential unstable debris and voids in the older fill prism.
- 2.17.3 Culvert shall be installed to grade (not perched or suspended), aligned with the natural stream channel, and extend lengthwise completely beyond the toe of fill. If culvert cannot be set to grade, it shall be oriented in the lower third of the fill face, and a downspout or energy dissipator (such as boulders, rip-rap, or rocks) shall be installed above or below the outfall as needed to effectively control stream bed, channel, or bank erosion (scouring, headcutting, or downcutting). The Permittee shall ensure basins are not constructed and channels are not be widened at culvert inlets.
- 2.17.4 Culvert bed shall be composed of either compacted rock-free soil or crushed gravel. Bedding beneath the culvert shall provide for even distribution of the load over the length of the pipe, and allow for natural settling and compaction to help the pipe settle into a straight profile. The crossing backfill materials shall be free of rocks, limbs, or other debris that could allow water to seep around the pipe, and shall be compacted.
- 2.17.5 Culvert inlet, outlet (including the outfall area), and fill faces shall be

armored where stream flow, road runoff, or rainfall energy is likely to erode fill material and the outfall area.

- 2.17.6 Permanent culverts shall be sized to accommodate the estimated 100-year flood flow [i.e. ≥ 1.0 times the width of the bankfull channel width or the 100-year flood size, whichever is greater], including debris, culvert embedding, and sediment loads.

2.18 Crossing Maintenance

- 2.18.1 The placement of armoring shall be confined to the work period when the stream is dry or at its lowest flow
- 2.18.2 No heavy equipment shall enter the wetted stream channel.
- 2.18.3 No fill material, other than clean rock, shall be placed in the stream channel.
- 2.18.4 Rock shall be sized to withstand washout from high stream flows and extend above the ordinary high-water level.
- 2.18.5 Rock armoring shall not constrict the natural stream channel width and shall be keyed into a footing trench with a depth sufficient to prevent instability.

2.19 Fords, Armored Fill and Vented Crossings.

- 2.19.1 Fords, armored and vented crossings are considered permanent watercourse encroachments and shall accommodate the 100-year flood flow plus associated sediment and debris.
- 2.19.2 Hydrologically-connected road approaches to fords, armored and vented crossings shall be rocked and maintained to avoid delivery of fine sediment to the watercourse below.
- 2.19.3 Fords, armored and vented crossings shall be sufficiently outsloped to minimize aggradation of suspended sediments at the crossing.
- 2.19.4 The lowest point of fords, armored and vented crossings shall be constructed within or directly over the original stream channel, to the extent feasible, in order to contain high flows up to twice bank-full and to avoid diversion potential.
- 2.19.5 Armor material shall be comprised of durable angular screened quarry rock of sufficient size and placement to minimize mobilization during a 100-year storm event. Wood may be used for armoring if sound, tight-grained, redwood is applied and sufficiently keyed into the fillslope to resist

movement during a 100-year storm event.

2.19.6 If maximum fill heights exceed 15 feet or fills exceed 500 cubic yards of fill, rock sizing, armoring thickness, chute width and chute depth shall be calculated and sized using the nomograph provided in Figure 23 of Cafferata et al (2017).

2.19.7 Stream crossing spillway fill slopes shall be armored from roadbed to the natural channel in a manner sufficient to prevent significant scour or removal of armor during high flows. Scour is expected through road surface rock cap.

2.20 Road Approaches. The Permittee shall treat road approaches to new or re-constructed permanent crossings *on Class I and II watercourses* to minimize erosion and sediment delivery to the watercourse. Permittee shall ensure road approaches are hydrologically disconnected to the maximum extent feasible to prevent sediment from entering the crossing site, including when a Stream Crossing is being constructed or reconstructed. Road approaches shall be armored from the crossing for a minimum of 50 feet in both directions, or to the nearest effective water bar or point where road drainage does not drain to the crossing, with durable rock, compacted grindings, pavement, or chip-seal.

Erosion Control and Pollution

2.21 Erosion Control. Permittee shall use erosion control measures throughout all work phases where sediment runoff threatens to enter the stream.

2.22 Seed and Mulch. Upon completion of construction operations and/or the onset of wet weather, Permittee shall restore all exposed or disturbed areas and access points within the stream and riparian zone by applying locally native, weed-free, grass seeds (use of Humboldt grass seed mix prohibited). Locally native wildflower and/or shrub seeds may also be included in the seed mix. Permittee shall mulch restored areas using at least two inches of weed-free clean straw or similar biodegradable mulch over the seeded area. Alternately, Permittee may cover seeding with jute netting, coconut fiber blanket, or similar non-synthetic monofilament netting erosion control blanket.

2.23 Erosion and Sediment Barriers. Permittee shall monitor and maintain all erosion and sediment barriers in good operating condition throughout the work period and the following rainy season, defined herein to mean October 15 through June 15. Maintenance includes, but is not limited to, removal of accumulated sediment and/or replacement of damaged sediment fencing, coir logs, coir rolls, and/or straw bale dikes. If the sediment barrier fails to retain sediment, Permittee shall employ corrective measures, and notify the department immediately.

- 2.24 Prohibition on Use of Monofilament Netting. To minimize the risk of ensnaring and strangling wildlife, Permittee shall not use any erosion control materials that contain synthetic (e.g., plastic or nylon) monofilament netting, including photo- or biodegradable plastic netting. Geotextiles, fiber rolls, and other erosion control measures shall be made of loose-weave mesh, such as jute, hemp, coconut (coir) fiber, or other products without welded weaves.
- 2.25 Site Maintenance. Permittee shall be responsible for site maintenance including, but not limited to, re-establishing erosion control to minimize surface erosion and ensuring drainage structures and altered streambeds and banks remain sufficiently armored and/or stable.
- 2.26 Cover Spoil Piles. Permittee shall have readily available erosion control materials such as wattles, natural fiber mats, or plastic sheeting, to cover and contain exposed spoil piles and exposed areas in order to prevent sediment from moving into the stream. Permittee shall apply and secure these materials prior to rain events to prevent loose soils from entering the stream.
- 2.27 No Dumping. Permittee shall not deposit, permit to pass into, or place where it can pass into a stream, lake, or other Waters of the State any material deleterious to fish and wildlife, or abandon, dispose of, or throw away within 150 feet of a stream, lake, or other Waters of the State any cans, bottles, garbage, motor vehicle or parts thereof, rubbish, litter, refuse, waste, debris, or the viscera or carcass of any dead mammal, or the carcass of any dead bird.

Project Inspection

- 2.28 Project Inspection. The Project shall be inspected by Clearwater Ag Services or an experienced and qualified professional to ensure that the Project (all work proposed) was implemented as designed. A copy of the inspection report, including photographs of each site, shall be submitted to CDFW within 90 days of completion of this project.

3. Reporting Measures

- 3.1 Work Completion. The proposed work shall be completed by no later than **October 15, 2022. Failure to complete work by this date shall result in suspension or revocation of this Agreement.** A notice of completed work (condition 2.4), with supplemental photos, shall be submitted to CDFW **within seven (7) days** of project completion.
- 3.2 Project Inspection. The Permittee shall submit the **Project Inspection Report** (condition 2.28) to CDFW, LSA Program at 619 2nd Street, Eureka, CA 95501.

CONTACT INFORMATION

Written communication that the Permittee or CDFW submits to the other shall be delivered to the address below unless the Permittee or CDFW specifies otherwise.

To Permittee:

Moriah Appel
P.O. Box 616
Whitethorn, CA 95589
831-818-9928
propgirlsheltercove@gmail.com

To CDFW:

Department of Fish and Wildlife
Northern Region
619 2nd Street
Eureka, CA 95501
Attn: Lake and Streambed Alteration Program
Notification #1600-2020-0053-R1

LIABILITY

The Permittee shall be solely liable for any violation of the Agreement, whether committed by the Permittee or any person acting on behalf of the Permittee, including its officers, employees, representatives, agents or contractors and subcontractors, to complete the project or any activity related to it that the Agreement authorizes.

This Agreement does not constitute CDFW's endorsement of, or require the Permittee to proceed with the project. The decision to proceed with the project is the Permittee's alone.

SUSPENSION AND REVOCATION

CDFW may suspend or revoke in its entirety this Agreement if it determines that the Permittee or any person acting on behalf of the Permittee, including its officers, employees, representatives, agents, or contractors and subcontractors, is not in compliance with the Agreement.

Before CDFW suspends or revokes the Agreement, it shall provide the Permittee written notice by certified or registered mail that it intends to suspend or revoke. The notice shall state the reason(s) for the proposed suspension or revocation, provide the Permittee an opportunity to correct any deficiency before CDFW suspends or revokes the Agreement, and include instructions to the Permittee, if necessary, including but not

limited to a directive to immediately cease the specific activity or activities that caused CDFW to issue the notice.

ENFORCEMENT

Nothing in the Agreement precludes CDFW from pursuing an enforcement action against the Permittee instead of, or in addition to, suspending or revoking the Agreement.

Nothing in the Agreement limits or otherwise affects CDFW's enforcement authority or that of its enforcement personnel.

OTHER LEGAL OBLIGATIONS

This Agreement does not relieve the Permittee or any person acting on behalf of the Permittee, including its officers, employees, representatives, agents, or contractors and subcontractors, from obtaining any other permits or authorizations that might be required under other federal, state, or local laws or regulations before beginning the project or an activity related to it.

This Agreement does not relieve the Permittee or any person acting on behalf of the Permittee, including its officers, employees, representatives, agents, or contractors and subcontractors, from complying with other applicable statutes in the FGC including, but not limited to, FGC sections 2050 *et seq.* (threatened and endangered species), 3503 (bird nests and eggs), 3503.5 (birds of prey), 5650 (water pollution), 5652 (refuse disposal into water), 5901 (fish passage), 5937 (sufficient water for fish), and 5948 (obstruction of stream).

Nothing in the Agreement authorizes the Permittee or any person acting on behalf of the Permittee, including its officers, employees, representatives, agents, or contractors and subcontractors, to trespass.

AMENDMENT

CDFW may amend the Agreement at any time during its term if CDFW determines the amendment is necessary to protect an existing fish or wildlife resource.

The Permittee may amend the Agreement at any time during its term, provided the amendment is mutually agreed to in writing by CDFW and the Permittee. To request an amendment, the Permittee shall submit to CDFW a completed CDFW "Request to Amend Lake or Streambed Alteration" form and include with the completed form payment of the corresponding amendment fee identified in CDFW's current fee schedule (see Cal. Code Regs., tit. 14, § 699.5).

TRANSFER AND ASSIGNMENT

This Agreement may not be transferred or assigned to another entity, and any purported transfer or assignment of the Agreement to another entity shall not be valid or effective, unless the transfer or assignment is requested by the Permittee in writing, as specified below, and thereafter CDFW approves the transfer or assignment in writing.

The transfer or assignment of the Agreement to another entity shall constitute a minor amendment, and therefore to request a transfer or assignment, the Permittee shall submit to CDFW a completed CDFW "Request to Amend Lake or Streambed Alteration" form and include with the completed form payment of the minor amendment fee identified in CDFW's current fee schedule (see Cal. Code Regs., tit. 14, § 699.5).

EXTENSIONS

In accordance with FGC section 1605(b), the Permittee may request one extension of the Agreement, provided the request is made prior to the expiration of the Agreement's term. To request an extension, the Permittee shall submit to CDFW a completed CDFW "Request to Extend Lake or Streambed Alteration" form and include with the completed form payment of the extension fee identified in CDFW's current fee schedule (see Cal. Code Regs., tit. 14, § 699.5). CDFW shall process the extension request in accordance with FGC 1605(b) through (e).

If the Permittee fails to submit a request to extend the Agreement prior to its expiration, the Permittee must submit a new notification and notification fee before beginning or continuing the project the Agreement covers (FGC section 1605(f)).

EFFECTIVE DATE

The Agreement becomes effective on the date of CDFW's signature, which shall be: 1) after the Permittee signature; 2) after CDFW complies with all applicable requirements under the California Environmental Quality Act (CEQA); and 3) after payment of the applicable FGC section 711.4 filing fee listed at http://www.wildlife.ca.gov/habcon/ceqa/ceqa_changes.html.

TERM

This Agreement shall **expire five years** from date of execution, unless it is terminated or extended before then. All provisions in the Agreement shall remain in force throughout its term. The Permittee shall remain responsible for implementing any provisions specified herein to protect fish and wildlife resources after the Agreement expires or is terminated, as FGC section 1605(a)(2) requires.

AUTHORITY

If the person signing the Agreement (signatory) is doing so as a representative of the Permittee, the signatory hereby acknowledges that he or she is doing so on the Permittee's behalf and represents and warrants that he or she has the authority to legally bind the Permittee to the provisions herein.

AUTHORIZATION

This Agreement authorizes only the project described herein. If the Permittee begins or completes a project different from the project the Agreement authorizes, the Permittee may be subject to civil or criminal prosecution for failing to notify CDFW in accordance with FGC section 1602.

CONCURRENCE

The undersigned accepts and agrees to comply with all provisions contained herein.

FOR MORIAH APPEL

Moriah Appel

Moriah Appel

6-1-2020

Date

FOR DEPARTMENT OF FISH AND WILDLIFE

Scott Bauer

Scott Bauer

Senior Environmental Scientist Supervisor

6/11/2020

Date



PLANNING DIVISION
PLANNING AND BUILDING DEPARTMENT
COUNTY OF HUMBOLDT

3015 H Street, Eureka, CA 95501
Phone (707) 445-7541 • Fax (707) 268-3792
<http://www.humboldt.gov.org/156>

Applicant

Moriah Appel
PO Box 616
Whitethorn, CA 95589

Owner

Moriah Appel
PO Box 616
Whitethorn, CA 95589

Agent

Clearwater Ag Services
Diana Totten
446 Maple Ln.
Garberville, CA 95542

**Notice of Administrative Decision
Provisional Zoning Clearance Certificate**

Date January 19, 2021
Assessor Parcel No. 221-221-009
Permit PLN-2019-16115
Contact Elizabeth Moreno - 268-3713

Description

A Zoning Clearance Certificate to authorize 4,260 square feet of existing outdoor cultivation.

Decision

The project was provisionally approved by Administrative Review on January 13, 2021.

PACKET INCLUDES:

On-Going Terms and Responsibilities

Please review the List of Measures in the Cannabis Compliance Agreement. All activity-specific and general terms and responsibilities shall be satisfied for the term of the clearance. The provisions of Exhibit A shall be completed within 12 months of the issuance date unless otherwise specified in the agreement. Please review these provisions carefully. Note: Other permits or approvals may be required from other state or local agencies before the project commences. An annual inspection will be conducted to verify compliance with the provisions of the zoning clearance certificate.

Cannabis Compliance Agreement

Refer to Exhibit A for the List of Measures to Achieve Compliance.

Effective Date

The effective date is January 13, 2021.

Expiration Date

The zoning clearance will expire after one (1) year from the date of issuance, and on the anniversary date of such issuance each year thereafter, unless an annual compliance inspection has been conducted and the permitted site has been found to comply with all requirements of the CMMLUO and the submitted application, including, but not limited to, the approved site plan, operations plan, and processing plan.

Extensions

If the terms of provisional approval for your project set forth in Exhibit B cannot be met before the expiration date, you may apply for an extension with the Planning Division. Extension applications must be submitted before the expiration date with the appropriate fees and must state the reason for the requested extension and provide a revised schedule for completion of the unmet items in Exhibit B. If the provisional zoning clearance certificate expires, a new application must be filed and accompanied by applicable fees. The new zoning clearance certificate may be subject to different processing requirements and standards. Contact your assigned planner if you have any questions about extensions.

Changes or Modifications to Project

If your project needs minor changes or major modifications, review and approval of the project by the Planning Division is required. Applications for changes or modifications must be filed and accompanied by applicable fees. Contact your assigned planner if you think your project needs to be changed or modified.

Zoning Clearances are Not Transferrable

The rights and privileges to conduct medical marijuana activities on a specific parcel do not attach to title to the property and are not conveyed with the lease or sale of the property. Accordingly, Zoning Clearance Certificates may not be sold, assigned, leased or otherwise conveyed or transferred by the person or entity holding the Zoning Clearance Certificate to any third party not named on the application without a modification of the clearance. Contact your assigned planner if you have any questions about this transfer limitation.



PLANNING AND BUILDING DEPARTMENT
PLANNING DIVISION
COUNTY OF HUMBOLDT

3015 H Street, Eureka, CA 95501
Phone (707) 445-7541 • Fax (707) 268-3792

Planning Division Decision Packet

The following packet of information includes your Planning Division permit results. **Please review the enclosed permit packet carefully.** The packet contains important information such as appeal periods, permit conditions, and the expiration date for your permit(s). Please take particular note of the following:

1. **Your permit does not require an appeal period.** It is effective immediately.
2. **All permit conditions must be completed prior to the expiration date.** Your permit(s) may also include conditions from other state or local agencies. If you have questions or need assistance, please contact the specific agency or department that issued the conditions.
3. **Proof of completion is required for most permit conditions.** For efficient staff review of condition completion, please consolidate proof of completion for all conditions into one package.
4. **You are responsible for tracking the expiration date of your permit(s).** An extension process is available if you need more time.
5. **Additional federal, state or local regulatory requirements may apply to your project.** These requirements may be administered by agencies other than the Planning Division, including any mitigation monitoring. It is your responsibility to obtain all necessary approvals before starting your project.
6. **Call your assigned planner if you have any questions.** Your assigned planner's contact information is provided below.

Elizabeth Moreno, Planner II
Voice: 707-268-3713
Fax: 707-268-3792
emoreno@co.humboldt.ca.us

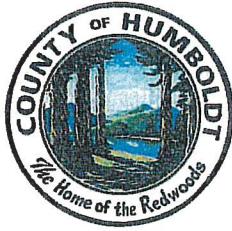

COUNTY OF HUMBOLDT
PLANNING AND BUILDING DEPARTMENT
CURRENT PLANNING DIVISION

3015 H Street Eureka CA 95501 Fax: (707) 268-3792 Phone: (707) 445-7541
<http://www.co.humboldt.ca.us/planning/>

ZONING CLEARANCE CERTIFICATE

Project: A Zoning Clearance Certificate to authorize 4,260 square feet of existing outdoor cultivation.

Project Location: This project is located in Humboldt County, in the Whitethorn area, on the east side of Crooked Prairie Road, approximately 2,300 feet southeast from the intersection of Crooked Prairie Road and China Creek Road, on the property known as 7050 Crooked Prairie Road.

Present Plan Designations: Residential Agriculture: 40 acres (RA40), Density: 40 acres per unit, 2017 General Plan, Slope Stability: Moderate Instability (2).

Present Zoning: Unclassified.

Record Number: PLN-2019-16115.

Assessor Parcel Number: 221-221-009.

Applicant

Moriah Appel
PO Box 616
Whitethorn, CA 95589

Owner

Moriah Appel
PO Box 616
Whitethorn, CA 95589

Agent

Clearwater Ag Services
Diana Totten
446 Maple Ln.
Garberville, CA 95542

Environmental Review: An Addendum to a previously adopted Environmental Impact Report has been prepared for consideration per §15164 of CEQA Guidelines.

Findings

Pursuant to Humboldt County Code Section 312-2.4, a Zoning Clearance Certificate shall be approved and issued by the Planning Director if, based on the submitted information provided by the applicant, it is found that:

1. The proposed development conforms with all requirements of the Humboldt County Zoning Regulations; and
2. The proposed development complies with the terms and conditions of any applicable permit and/or subdivision map that was previously approved for such development; and
3. The proposed development is not located on the same lot where conditions or activities are being conducted which are a part of the proposed development and in violation of the Humboldt County Code, unless the zoning clearance is necessary for the abatement of the existing violation

Facts

An application has been submitted to the Planning Division for a Zoning Clearance Certificate for 4,260 square feet (SF) of existing outdoor commercial cannabis cultivation. This commercial cannabis activity is authorized by Section 314-55.4.6.1.2 of the Commercial Cannabis Land Use Ordinance No. 2599 (CCLUO). The application meets the requirements of zoning, siting criteria (55.4.6.4.1, 55.4.6.4.2, 55.4.6.4.3), setbacks, and listed incompatible uses (e.g., schools), and is accompanied by the documentation, plans, descriptions, and agency clearances set forth in the CCLUO.

The applicant is seeking approval for a Zoning Clearance Certificate for 4,260 square feet (30x66.5' hoop house) pre-existing outdoor commercial cannabis cultivation.

The water for irrigation if sourced from rainwater catchment collected from the roof of the cabin. Rainwater will be collected from the roof of three existing storage area rooftops and stored in ten 5,000-gallon hard tanks, for a total of 50,000 gallons.

Estimated annual water use for the cultivation operation is 50,000 gallons. A metering device shall be installed and maintained at or near the outlet of all water storage facilities utilized for irrigation. The applicant shall maintain a weekly record of all water used in irrigation of permitted cultivation areas.

The applicant is to submit a Site Management Plan. Applicant is required to adhere to and implement the requirements contained in the SWRCB's Cannabis Cultivation Policy, the General Order and the Notice of Applicability. A copy of the reporting form portion of the Mitigation and Reporting Program (MRP) shall be submitted annually to the Planning and Building Department concurrent with the submittal to the SWRCB.

Monofilament netting for all uses will be prohibited. Geotextiles, fiber rolls, and other erosion control measure materials will be made of loose-weave mesh, such as jute, hemp, coconut (coir) fiber, or other products without welded weaves to minimize the risk of ensnaring and strangling wildlife. Wildlife will be left unharmed. If any wildlife is encountered during the Authorized Activity, Permittee will not disturb the wildlife and will allow wildlife to leave the work site unharmed. All refuse will be contained in wildlife proof storage containers, at all times, and disposed of at an authorized waste management facility.

Pursuant to section 5.4.6.3.1 of the CCLUO, the energy source, must be exclusively provided by a renewable energy source. The applicant proposes to use solar power to power fans. The applicant shall submit a noise study that states that the ambient levels, prior to starting operations. The applicant will conduct another study after the operations are permitted and submit it to the Planning Department. Noise from cultivation and related activities shall not result in an increase of more than three decibels of continuous noise above existing ambient noise levels at any property line of the site.

The project was referred to the Division of Environmental Health and recommended approval. However, the applicant will not process onsite and will not have any employees onsite.

The project was referred to the Bear River Band of the Rohnerville Rancheria, who recommended inadvertent discovery requirements. Additionally, the applicant will meet all Cal FIRE SRA Fire Safe Regulations.

The parcel is accessed of Briceland Throne Road onto Blue Slide Road onto Crooked Prairie Road. The applicant submitted a Road Evaluation self-certifying that the access road is an equivalent to a road Category 4 standard. The Department of Public Works has commented and recommended approval with the condition that the applicant pave the surface at the location of the access road which is Briceland Throne Road, the access road shall be paved for a minimum width of 20 feet and a length of 50 feet where it intersects the County road. This condition shall be completed to the satisfaction of the Department of Public Works prior to commencing operations, final sign-off for a building permit, or Public Works approval for a business license. The project is conditioned as such. Within one year, of issuance of this permit, the applicant is to join or start a Road Maintenance Association and provide evidence to the Planning Department.

The project was referred to the Bear River Band of the Rohnerville Rancheria, who recommended inadvertent discovery requirements. Additionally, the applicant will meet all Cal FIRE SRA Fire Safe Regulations.

The subject parcel has been determined to be one legal parcel as described in Creation Deed 1910-015612.

Determination

It is the determination of the Planning Division that:

- A Zoning Clearance Certificate is approved. The terms and responsibilities set forth in the CCLUO shall be satisfied by the Permittee for the life of this clearance.
- A Provisional Zoning Clearance Certificate is approved subject to the terms of the attached Compliance Agreement. The terms and responsibilities set forth in the CCLUO shall also be satisfied by the Permittee for the life of this clearance.
- The Zoning Clearance Certificate application is denied. The reasons for this denial are set forth in the analysis above.

Issued By: _____

John H. Ford
Director, Planning and Building Department

Date: _____

11/13/2024

**ATTACHEMENT 1
CEQA Addendum**

**CEQA ADDENDUM TO THE
FINAL ENVIRONMENTAL IMPACT REPORT FOR THE COMMERCIAL CANNABIS LAND USE
ORDINANCE**

***Commercial Cannabis Land Use Ordinance Final Environmental Impact Report (EIR)
(State Clearinghouse # 2017042022), January 2018***

APNs 221-221-009, 7050 Crooked Prairie Road, Whitethorn, County of Humboldt

**Prepared By
Humboldt County Planning and Building Department
3015 H Street, Eureka, CA 95501**

December 2020

Background

Modified Project Description and Project History –

The Commercial Cannabis Land Use Ordinance (CCLUO) updated the County's existing Commercial Medical Marijuana Land Use Ordinance (Section 313-55.4 and 314-55.4 of Chapter 3 of Division 1 of Title III of the County Code) as well as repeal of the Medical Cannabis Testing and Research Laboratories provisions and on-site consumption prohibition found in Sections 313-55.3.15, 314-55.3.15, 313-55.3.11.7, and 314-55.3.11.7 of Division 1 of Title III of the County Code, respectively. These regulations establish land use regulations for the commercial cultivation, processing, manufacturing, distribution, testing, and sale of cannabis within the County. These regulations were developed in concert with the Final Environmental Impact Report (EIR) that was adopted for the ordinance in order to implement the mitigation measures of the EIR. The EIR addressed the broad environmental impacts that could be expected to occur from the adoption and implementation of the ordinance. The EIR specified that the regulations established in the CCLUO would mitigate the impacts of existing cannabis operations by establishing regulations for an existing unregulated land use to help prevent and reduce environmental impacts that are known to result from unpermitted baseline cultivation operations. The EIR prepared for the CCLUO also established local land use regulations to allow for continued commercial cannabis operations in the unincorporated area of the County that ensure the health and safety of residents, employees, County visitors, neighboring property owners and end users of cannabis. The proposed project is consistent with all regulations within the CCLUO and all mitigation measures of the EIR. New commercial cannabis cultivation on parcels zoned Unclassified was included in the environmental baseline for the EIR. The current project was contemplated by the EIR and compliance with the provisions of the CCLUO will fully mitigate all environmental impacts of the project to a less than significant level.

The modified project is for application has been submitted to the Planning Division for a Zoning Clearance Certificate for 4, 260 square feet of existing outdoor commercial cannabis cultivation. This commercial cannabis activity is authorized by Section 314-55.4.6.1.2 of the Commercial Cannabis Land Use Ordinance No. 2599 (CCLUO). The application meets the requirements of zoning, siting criteria (55.4.6.4.1, 55.4.6.4.2, 55.4.6.4.3), setbacks, and listed incompatible uses (e.g., schools), and is accompanied by the documentation, plans, descriptions, and agency clearances set forth in the CCLUO.

The water for irrigation if sourced from rainwater catchment collected from the roof of the cabin. Rainwater will be collected from the roof of three existing storage area rooftops and stored in ten 5,000-gallon hard tanks, for a total of 50,000 gallons.

Estimated annual water use for the cultivation operation is 50,000 gallons. A metering device shall be installed and maintained at or near the outlet of all water storage facilities utilized for irrigation. The applicant shall maintain a weekly record of all water used in irrigation of permitted cultivation areas.

The applicant is to submit a Site Management Plan. Applicant is required to adhere to and implement the requirements contained in the SWRCB's Cannabis Cultivation Policy, the General Order and the Notice of Applicability. A copy of the reporting form portion of the Mitigation and Reporting Program (MRP) shall be submitted annually to the Planning and Building Department concurrent with the submittal to the SWRCB.

Monofilament netting for all uses will be prohibited. Geotextiles, fiber rolls, and other erosion

control measure materials will be made of loose-weave mesh, such as jute, hemp, coconut (coir) fiber, or other products without welded weaves to minimize the risk of ensnaring and strangling wildlife. Wildlife will be left unharmed. If any wildlife is encountered during the Authorized Activity, Permittee will not disturb the wildlife and will allow wildlife to leave the work site unharmed. All refuse will be contained in wildlife proof storage containers, at all times, and disposed of at an authorized waste management facility.

Pursuant to section 5.4.6.3.1 of the CCLUO, the energy source, must be exclusively provided by a renewable energy source. The applicant proposes to use solar power to power fans. The applicant shall submit a noise study that states that the ambient levels, prior to starting operations. The applicant will conduct another study after the operations are permitted and submit it to the Planning Department. Noise from cultivation and related activities shall not result in an increase of more than three decibels of continuous noise above existing ambient noise levels at any property line of the site.

The project was referred to the Division of Environmental Health and recommended approval. However, the applicant will not process onsite and will not have any employees onsite.

The parcel is accessed of Briceland Throne Road onto Blue Slide Road onto Crooked Prairie Road. The applicant submitted a Road Evaluation self-certifying that the access road is an equivalent to a road Category 4 standard. The Department of Public Works has commented and recommended approval with the condition that the applicant pave the surface at the location of the access road which is Briceland Throne Road, the access road shall be paved for a minimum width of 20 feet and a length of 50 feet where it intersects the County road. This condition shall be completed to the satisfaction of the Department of Public Works prior to commencing operations, final sign-off for a building permit, or Public Works approval for a business license. The project is conditioned as such. Within one year, of issuance of this permit, the applicant is to join or start a Road Maintenance Association and provide evidence to the Planning Department.

The project was referred to the Bear River Band of the Rohnerville Rancheria, who recommended inadvertent discovery requirements. Additionally, the applicant will meet all Cal FIRE SRA Fire Safe Regulations.

The project will comply with the provision of the CCLUO intended to eliminate impacts to sensitive species from noise and light. Compliance with these and other measures of the CCLUO ensure consistency with the EIR.

Purpose - Section 15164 of the California Environmental Quality Act (CEQA) provides that the lead agency shall prepare an addendum to a previously certified Final Environmental Impact Report (EIR) if some changes or additions are necessary but none of the conditions described in Section 15162 calling for a subsequent EIR or Negative Declaration have occurred. Section 15162 states that when an EIR has been certified for a project, no subsequent EIR shall be prepared for that project unless the lead agency determines, on the basis of substantial evidence in the light of the whole record, one or more of the following:

1. Substantial changes are proposed in the project which require major revisions of the previous EIR due to the involvement of new significant environmental effects or a substantial increase in the severity of previously identified significant effects;

2. Substantial changes occur with respect to the circumstances under which the project is undertaken which will require major revisions of the previous EIR due to the involvement of new significant environmental effects or a substantial increase in the severity of previously identified significant effects; or
3. New information of substantial importance, which was not known and could not have been known with the exercise of reasonable diligence at the time the Final EIR was certified as complete, shows any of the following: A) the project will have one or more significant effects not discussed in the previous Final EIR; B) significant effect previously examined will be substantially more severe than shown in the Final EIR; C) mitigation measures or alternatives previously found not to be feasible would in fact be feasible and would substantially reduce one or more significant effects of the project, but the project proponents decline to adopt the mitigation measure or alternative; or D) mitigation measures or alternatives which are considerably different from those analyzed in the Final EIR would substantially reduce one or more significant effects on the environment, but the project proponents decline to adopt the mitigation measure or alternative.

Summary of Significant Project Effects and Mitigation Recommended

No changes are proposed for the Final EIR recommended mitigations. The proposal to authorize the project in compliance with the CCLUO is fully consistent with the impacts identified and adequately mitigated in the Final EIR. The project as conditioned to implement responsible agency recommendations, results in no significantly adverse environmental effects beyond those identified in the Final EIR.

Other CEQA Considerations

Staff suggests no changes for the revised project.

EXPLANATION OF DECISION NOT TO PREPARE A SUPPLEMENTAL MITIGATED NEGATIVE DECLARATION OR ENVIRONMENTAL IMPACT REPORT

See Purpose statement above.

In every impact category analyzed in this review, the projected consequences of the current project proposal are either the same or less than significantly increased than the initial project for which the EIR was adopted. Based upon this review, the following findings are supported:

FINDINGS

1. The proposed project will permit an existing cannabis operation and bring the operation into compliance with county and state requirements intended to adequately mitigate environmental impacts.
2. The circumstances under which the project was approved have not changed substantially. There are no new significant environmental effects and no substantial increases in the severity of previously identified effects.
3. For the current proposed project, there has been no new information of substantial importance, which was not known and could not have been known with the

exercise of reasonable diligence at the time the previous EIR was adopted as complete.

CONCLUSION

Based on these findings it is concluded that an Addendum to the previous Final EIR is appropriate to address the requirements under CEQA for the current project proposal. All of the findings, mitigation requirements, and mitigation and monitoring program of the EIR, remain in full force and effect on the original project.

**ATTACHMENT 2
CANNABIS COMPLIANCE AGREEMENT**

This Agreement is entered into this 13th day of January, 2021, by and between the County of Humboldt ("County"), Moriah Appel ("Applicant"), and ("Owner"), regarding property located at 7050 Crooked Prairie Road, Whitethorn CA. Assessor's Parcel Number (APN) 221-221-009.

RECITALS

WHEREAS, on January 20, 2016, the Board of Supervisors of Humboldt County adopted Humboldt County Code ("HCC") Sections 313-55.4.11 and 314-55.4.11, allowing a property owner, under limited circumstances, to obtain a building permit or zoning clearance certificate to conduct commercial cannabis activity (Commercial Cannabis Permit) even though violations of the HCC, statute, and/or applicable regulation related to the commercial cannabis activity exist on the property, provided property owner and applicant execute an agreement with the County to cure the violations; and

WHEREAS, the County is utilizing this Compliance Agreement ("Agreement") to allow Applicant to secure permits to perform certain work associated with the Zoning Clearance Certificate for 4,260 square feet of cannabis cultivation (Record No. PLN-2019-16115); and

WHEREAS, pursuant to the authority provided in HCC Section 312-2.4.1.3, County will issue a Zoning Clearance Certificate or a Building Permit on the subject property and, in exchange, Applicant and Owner guarantee that the existing violations on the land will be cured within a prescribed period of time, stated below; and

WHEREAS, Applicant and Owner acknowledge that there are existing violations of the HCC, statute, or applicable regulation related to the commercial cannabis activity exist on the property, to wit, the unpermitted structures that have a nexus with the cultivation; and

WHEREAS, Applicant and Owner agree that a code enforcement action pursuant to HCC Sections 351-1 et seq., 2131-1 et seq., 2121-1 et seq., and any other applicable county or state law or regulation shall become active if the terms of this agreement are not fulfilled.

NOW, THEREFORE, in consideration of the faithful performance of the terms, conditions, and promises set forth in this Agreement, the Parties agree as follows:

1. **Acknowledgment of Violations.** Applicant, Owner, and County acknowledge and agree that there are existing violations of the HCC, statute, and/or applicable regulation on the property located in Humboldt County, at 7050 Crooked Prairie Road, Whitethorn CA. Assessor's Parcel Number (APN) 221-221-009, the violations consist of the, unpermitted structures and grading that have a nexus with the cultivation.
2. **Remedy for the Violations.** The Parties agree that to cure the violations on the property owner and Applicant must undertake the activities and schedule described in Exhibit A:

3. Issuance of Permit. The Parties agree that the provisional approval of the clearance or permit and issuance of any Commercial Cannabis Permit(s) is being made solely upon the representation by the Owner and Applicant in this Agreement that the violations on the property will be cured within the time frame in this Agreement. Any and all failures by the Owner and Applicant to cure the violations on the property within the prescribed time set forth in paragraph 5, below, shall be grounds for revocation of the approval pursuant to HCC Section 312-14.1.
4. Consent to Inspection. Owner and Applicant consent to all inspections of the property as needed, at any time during business hours from Monday to Friday, while this Agreement is in effect, by the Code Enforcement Unit, Division of Environmental Health, Planning and Building, and any other agencies or departments that may need to inspect the property to determine that the terms of this Agreement are being fulfilled.
5. Time Limit to Cure the Violations. The Parties agree that the Owner and Applicant will cure the existing violations at the earliest feasible date, but in no event no more than two (2) years of issuance of a provisional clearance or permit. Furthermore, Owner and Applicant must provide plans for curing such violations to the Planning and Building Department within one (1) year of issuance of the provisional clearance or permit. The time to cure the violations may only be extended upon request by Owner and Applicant if approved in writing after due consideration and a finding of good cause by the Director.
6. Failure to Cure the Violations. The Parties agree that if the Owner and Applicant fail to cure the violations on the property within the prescribed time limit, and no extension is granted by the Director, then a code enforcement file will become active, and the County shall pursue all legal and administrative remedies against the Owner and Applicant, as allowed by local and state law, to ensure that the violations on the property are cured.
7. Termination. The Parties agree that once Owner and Applicant have cured the violations on the property and the County, after inspecting the property, agrees in writing that all violations on the property are cured, then this Agreement shall terminate.
8. Lawful Construction. All repair, construction and reconstruction on the property shall be done in accordance with all applicable County and state codes, laws, and regulations. Owner and Applicant agree that they shall obtain the necessary permits PRIOR to any repair, construction or reconstruction of the property.
9. Waiver. The failure of the County to proceed against the Property Owners in an enforcement action, whether administrative, civil or criminal, for any violation of the applicable ordinance, this Agreement and/or state or local law or regulation shall not constitute or be deemed a waiver of the County's right to proceed against Owner and/or Applicant for any subsequent violation. Nothing in this Agreement shall limit in any manner the authority of the County to apply and/or enforce any provisions of the County's code or state law or regulation to the Owner and Applicant and activities occurring on the property.
10. Notices. All notices required by this Agreement shall be sent, at a minimum, via first class United States Mail with postage prepared to the Parties as follows:

To County:
Director, Planning and Building Department
3015 H Street
Eureka, CA 95501

To Property Owners:
Moriah Appel
PO Box 616
Whitethorn, CA 95589

To Applicant:
Moriah Appel
PO Box 616
Whitethorn, CA 95589

Notices shall be deemed served upon deposit in the United States mail.

11. Indemnification. Owner and Applicant shall indemnify, defend and hold harmless the County, its officers, agents and employees from and against any and all claims or suits for damages or injury arising from the issuance of a Commercial Cannabis Permit or other permits for the property located 7050 Crooked Prairie Road, Whitethorn CA. Assessor's Parcel Number (APN) 221-221-009 compliance with or failure to abide by the Commercial Cannabis Permit or the terms of this Agreement, and against and from all costs, attorney's fees, expenses and liabilities related to any claim or any action or proceeding brought within the scope of this indemnification.
12. Binding on Successors. This Agreement is binding on the heirs, successors and assigns of the Parties. In the event of a permit transfer, a new compliance agreement must be executed. In the event of property transfer, the Seller and Applicant have an affirmative duty to inform the Buyer of this Compliance Agreement. Seller and Applicant must also provide written proof of Buyer notification to the County.
13. Amendment. This Agreement may be amended, modified or changed by the Parties provided that said amendment, modification or change is in writing and approved by all Parties.
14. Entire Agreement. This Agreement contains the entire compliance agreement between the Parties and all prior or contemporaneous agreements, understandings, representations and statements, oral or written, regarding Sections 313-55.4.11(a) and 314-55.4.11(a) of the HCC are superseded by this Agreement.
15. Annual Inspection This Agreement is incorporated as a condition of approval for the provisional clearance or permit for commercial cannabis activity. Completion of the agreement shall be reviewed during the annual inspection process.
16. Severability. If any term, provision, promise or condition of this Agreement is held by a court with jurisdiction to decide on the matter to be invalid, void or unenforceable, the remaining provisions of this Agreement shall continue in full force and effect, unless the rights and obligations of the parties have been materially altered or abridged by such invalidation, voiding or unenforceability.

Edwards Excavation & Restoration

P.O. Box 245
Whitethorn, Ca 95589
Phone (707)496-3353
edwardsexcavation@hotmail.com
General Engineering Contractor Lic.#971935

Estimate

Date	Estimate #
10/27/2021	4

Moriah Apple
831-818-9928

Description	Qty	Rate	Total
Job Location: 7050 Crooked Prairie -Notification		0.00	0.00
#1600-2020-0053-R1 Streambed Alteration Agreement			
Job Description: Crossing #1-Replacing undersized misalignment culvert with 24"x 50' culvert. Crossing #2-replcing culvert with rocked ford.		0.00	0.00
Mobilization & Demobilization	1	1,740.00	1,740.00
Equipment	1	3,000.00	3,000.00
Materials	1	11,400.00	11,400.00
Labor	1	1,200.00	1,200.00
Trucking	1	6,000.00	6,000.00
Total			\$23,340.00



FOR DEPARTMENT USE ONLY				
Date Received	Amount Received	Amount Due	Date Complete	Notification No.
	\$	\$		
Assigned to:				

NOTIFICATION OF LAKE OR STREAMBED ALTERATION

Complete EACH field, unless otherwise indicated, following the instructions and submit ALL required enclosures, attachments, and fee(s) to the CDFW regional office that serves the area where the project will occur. Attach additional pages to notification, if necessary.

1. APPLICANT PROPOSING PROJECT

Name	Moriah Appel
Business/Agency	N/A
Mailing Address	PO Box 616
City, State, Zip	Whitethorn Calif. 95589
Phone Number	831-818-9928
Email	propgirlsheltercove@gmail.com

2. CONTACT PERSON *(Complete only if different from applicant.)*

Name	Diana Totten
Business/Agency	Clearwater Ag Services
Mailing Address	446 Maple Lane
City, State, Zip	Garberville Cal 95542
Phone Number	707-923-2767
Email	clearwateragservices@gmail.com

While an applicant is legally responsible for complying with Fish and Game Code section 1602 et seq., an applicant may designate and authorize an agent (e.g., lawyer, consultant, or other individual) to act as a Designated Representative. The Designated Representative is authorized to sign the notification and any agreement on behalf of the Applicant.

Do you authorize the Contact Person above to represent you as your Authorized Designated Representative?

Yes, I authorize. No, I do not authorize.

3. PROPERTY OWNER *(Complete only if different from applicant)*

Name	
Mailing Address	
City, State, Zip	
Phone Number	
Email	



4. PROJECT NAME AND AGREEMENT TERM

A. Project Name		Maggie			
B. Agreement Term Requested		<input checked="" type="checkbox"/> Regular (5 years or less) <input type="checkbox"/> Long-term (greater than 5 years)			
C. Project Term		Beginning (year)	2020	Ending (year)	2025
D. Seasonal Work Period					
Season(s)*	Start Date (month/day)	End Date (month/day)		E. Number of Work Days	
1	04/01	10/31		210	
2					
3					
4					
5					

* Continue on additional page(s) if necessary

5. AGREEMENT TYPE

Check the applicable box. If boxes B – F are checked, complete the specified attachment.

A.	<input checked="" type="checkbox"/> Standard (Most construction projects, excluding the categories listed below)	
B.	<input type="checkbox"/> Gravel/Sand/Rock Extraction (Attachment A)	Mine I.D. Number: _____
C.	<input type="checkbox"/> Timber Harvesting (Attachment B)	THP Number: _____
D.	<input type="checkbox"/> Water Diversion/Extraction/Impoundment (Attachment C)	SWRCB Number: _____
E.	<input type="checkbox"/> Routine Maintenance (Attachment D)	
F.	<input checked="" type="checkbox"/> Cannabis Cultivation (Attachment E)	
G.	<input type="checkbox"/> CDFW Grant Programs	Agreement Number: _____
H.	<input type="checkbox"/> Master	
I.	<input type="checkbox"/> Master Timber Operations	



6. FEES

See the current fee schedule to determine the appropriate notification fee. Itemize each project's estimated cost and corresponding fee. **Note: CDFW may not process this notification until the correct fee has been received.**

A. Project Name		B. Project Cost	C. Project Fee
1	Maggie Watercourse Crossing Culvert	\$500	\$609.25
2	Removal of culvert for armored crossing	\$1,200	\$609.25
3			
4			
5			
6			
7			
8			
9			
10			
		D. Base Fee (if applicable)	
		E. TOTAL FEE*	\$1,218.50

* Check, money order, and Visa or MasterCard (select Environmental Fees from Menu) payments are accepted.

7. PRIOR NOTIFICATION AND ORDERS

A. Has a notification previously been submitted to, or a Lake or Streambed Alteration Agreement previously been issued by, CDFW for the project described in this notification?

Yes (Provide the information below) No

Applicant	Notification Number	Date

B. Is this notification being submitted in response to a court or administrative order or notice, or a notice of violation (NOV) issued by CDFW?

Yes No (Enclose a copy of the order, notice, or NOV. If the applicant was directed to notify CDFW verbally rather than in writing, identify the person who directed the applicant to submit this notification, the agency he or she represents, and describe the circumstances relating to the order.)

Name of person who directed notification	Agency

Describe circumstances relating to order

Continued on additional page(s)



8. PROJECT LOCATION

<p>A. Address or description of project location. <i>(Include a map that marks the location of the project with a reference to the nearest city or town, and provide driving directions from a major road or highway.)</i></p> <p>This project is in the Crooked Prairie area of Briceland. Take 101 South to exit 642 to Redwood Dr.. Proceed to Redway and take the Briceland Thorn Road approx. 7 miles West to China Creek Road. Follow China Creek Road 4.5 miles to Crooked Prairie Road and proceed .1 mile to driveway on the left at 7050 Crooked Prairie Road.</p> <p style="text-align: right;"><input checked="" type="checkbox"/> Continued on additional page(s)</p>				
B. River, stream, or lake affected by the project.		Blue Slide Creek		
C. What water body is the river, stream, or lake tributary to?		Mattole River		
D. Is the river or stream segment affected by the project listed in the state or federal <u>Wild and Scenic Rivers Acts</u> ?		<input type="checkbox"/> Yes <input type="checkbox"/> No <input checked="" type="checkbox"/> Unknown		
E. County		Humboldt		
F. USGS 7.5 Minute Quad Map Name		G. Township	H. Range	I. Section
Briceland		4S	2E	9
<input type="checkbox"/> Continued on additional page(s)				
K. Meridian (check one)		<input checked="" type="checkbox"/> Humboldt <input type="checkbox"/> Mt. Diablo <input type="checkbox"/> San Bernardino		
L. Assessor's Parcel Number(s)				
221-221-009				
<input type="checkbox"/> Continued on additional page(s)				
M. Geographic coordinates <i>(Provide the latitude and longitude coordinates for the property where the project(s) will take place. CDFW utilizes decimal degrees and WGS 84 datum. Access Google Maps Help if you need assistance in finding your coordinates.)</i>				
Latitude/Longitude	Latitude: 40.1344		Longitude: 123.9631	
	Latitude:		Longitude:	
	Latitude:		Longitude:	
	Latitude:		Longitude:	
	Latitude:		Longitude:	



9. PROJECT CATEGORY

WORK TYPE	NEW CONSTRUCTION	REPLACE EXISTING STRUCTURE	REPAIR-MAINTAIN-OPERATE EXISTING STRUCTURE
Bank stabilization – bioengineering/recontouring	<input type="checkbox"/>	<input type="checkbox"/>	<input type="checkbox"/>
Bank stabilization – rip-rap/retaining wall/gabion	<input type="checkbox"/>	<input type="checkbox"/>	<input checked="" type="checkbox"/>
Boat dock/pier	<input type="checkbox"/>	<input type="checkbox"/>	<input type="checkbox"/>
Boat ramp	<input type="checkbox"/>	<input type="checkbox"/>	<input type="checkbox"/>
Bridge	<input type="checkbox"/>	<input type="checkbox"/>	<input type="checkbox"/>
Channel clearing/vegetation management	<input type="checkbox"/>	<input type="checkbox"/>	<input type="checkbox"/>
Culvert	<input type="checkbox"/>	<input type="checkbox"/>	<input checked="" type="checkbox"/>
Debris basin	<input type="checkbox"/>	<input type="checkbox"/>	<input type="checkbox"/>
Dam	<input type="checkbox"/>	<input type="checkbox"/>	<input type="checkbox"/>
Filling of wetland, river, stream, or lake	<input type="checkbox"/>	<input type="checkbox"/>	<input type="checkbox"/>
Geotechnical survey	<input type="checkbox"/>	<input type="checkbox"/>	<input type="checkbox"/>
Habitat enhancement – revegetation/mitigation	<input type="checkbox"/>	<input type="checkbox"/>	<input type="checkbox"/>
Levee	<input type="checkbox"/>	<input type="checkbox"/>	<input type="checkbox"/>
Low water crossing	<input type="checkbox"/>	<input type="checkbox"/>	<input type="checkbox"/>
Road/trail	<input type="checkbox"/>	<input type="checkbox"/>	<input type="checkbox"/>
Sediment removal: pond, stream, or marina	<input type="checkbox"/>	<input type="checkbox"/>	<input type="checkbox"/>
flood control	<input type="checkbox"/>	<input type="checkbox"/>	<input type="checkbox"/>
Storm drain outfall structure	<input type="checkbox"/>	<input type="checkbox"/>	<input type="checkbox"/>
Temporary stream crossing	<input type="checkbox"/>	<input type="checkbox"/>	<input type="checkbox"/>
Utility crossing: horizontal directional drilling	<input type="checkbox"/>	<input type="checkbox"/>	<input type="checkbox"/>
jack/bore	<input type="checkbox"/>	<input type="checkbox"/>	<input type="checkbox"/>
open trench	<input type="checkbox"/>	<input type="checkbox"/>	<input type="checkbox"/>
Water diversion without facility	<input type="checkbox"/>	<input type="checkbox"/>	<input type="checkbox"/>
Water diversion with facility	<input type="checkbox"/>	<input type="checkbox"/>	<input type="checkbox"/>
Other (specify):	<input type="checkbox"/>	<input type="checkbox"/>	<input type="checkbox"/>



10. PROJECT DESCRIPTION

- A. Describe the project in detail. Include photographs of the project location and immediate surrounding area.
- Written description of all project activities with detailed step-by-step description of project implementation.
 - Include any structures (e.g., rip-rap, culverts) that will be placed or modified in or near the stream, river, or lake, and any channel clearing.
 - Specify volume, and dimensions of all materials and features (e.g., rip rap fields) that will be used or installed.
 - If water will be diverted or drafted, specify the purpose or use and include Attachment C.
 - Enclose diagrams, drawings, design plans, construction specifications, and maps that provide all of the following: site specific construction details; dimensions of each structure and/or extent of each activity in the bed, channel, bank or floodplain; overview of the entire project area (i.e., "bird's-eye view") showing the location of each structure and/or activity, significant area features, stockpile areas, areas of temporary disturbance, and where the equipment/machinery will access the project area.
 - A helpful resource to assist in the development of quality PDF maps in Google Earth. See Using Google Earth to Map your Property (PDF).

There are 2 projects on this parcel.

The first project is for one water course crossing on the driveway to the residence and cultivation area. The culvert is an existing 18"x 20' CMP. The drainage area is approximately 4.4 acres. This culvert is in good working order and meets the 100 year flood event sizing. The stream is a class 3 and photos show the watercourse as approximately 12-16 inches in width and 6 inches in dept at the erosion marks of banks of the watercourse. The rust line is approximately 2" of bottom of the culvert. The outlet is shotgunned and drops approximately 5'6".

Recommend placement of 6 cu. yds. of 12"-18" rip-rap to dissipate the outflow of the culvert to reduce erosion and sediment discharge.
 Clear inlet of material and debris.

The second project is to remove an existing 18" culvert in what appears to be a class 4 watercourse but has no evidence of a defined channel or watercourse.

Recommend removing culvert and installing an armored crossing. After removing culvert, shape a rolling dip armored crossing using 5 cu. yds. of 4"-6" fractured rock to line the crossing using guidelines from the Handbook for Forest, Ranch and Rural Roads.

Cultivation irrigation water comes from rain catchment from roof of residence.

Continued on additional page(s)

B. Specify the equipment and machinery that will be used to complete the project.

Mini Excavator
 Dump Truck
 Hand Tools such as shovels and rakes

Continued on additional page(s)

C. Will water be present during the proposed work period (specified in box 4.D) in the stream, river, or lake (specified in box 8.B). Yes No (Skip to box 11)

D. Will the project require work in the wetted portion of the channel? Yes (Enclose a plan to divert water around work site) No



11. PROJECT IMPACTS

A. Describe impacts to the bed, channel, and bank of the river, stream, or lake, and the associated riparian habitat. Specify the dimensions of the modifications in length (linear feet) and area (square feet or acres) and the type and volume of material (cubic yards) that will be moved, displaced, or otherwise disturbed, if applicable.

Potential impacts will be to local fish and wildlife such as Steelhead, Coho Salmon, Chinook Salmon, Southern Torrent Salamander, Foothill Yellow-legged Frog, Red-bellied Newt. and other fish, wildlife, birds, amphibians, plants and reptiles.
 All work will be done in the dry season with no water present. Increased water quality will be enhanced by the completion of the project.

Continued on additional page(s)

B. Will the project affect any vegetation?

Yes (Complete the tables below) No (Include aerial photo with date supporting this determination)

Vegetation Type	Temporary Impact	Permanent Impact
	Linear feet: _____ Total area: _____	Linear feet: _____ Total area: _____
	Linear feet: _____ Total area: _____	Linear feet: _____ Total area: _____

Tree Species	Number of Trees to be Removed	Trunk Diameter (range)

Continued on additional page(s)

C. Are any special status animal or plant species, or habitat that could support such species, known to be present on or near the project site?

Yes (List each species and/or describe the habitat below) No Unknown

Continued on additional page(s)

D. Identify the source(s) of information that supports a "yes" or "no" answer above in Box 11.C.

CNDDDB

Continued on additional page(s)

E. Has a biological study been completed for the project site?

Yes (Enclose the biological study) No

Note: A biological assessment or study may be required to evaluate potential project impacts on biological resources.



F. Has one or more technical studies (e.g., engineering, hydrologic, geological, or geomorphological) been completed for the project or project site?

Yes (Enclose the study(ies)) No

Note: One or more technical studies may be required to evaluate potential project impacts to a lake or streambed.

G. Have fish or wildlife resources or waters of the state been mapped or delineated on the project site?

Yes (Enclose the mapped results) No

Note: Check "yes" if fish and wildlife resources or waters of the state on the project site have been mapped or delineated. "Wildlife" means and includes all wild animals, birds, plants, fish, amphibians, reptiles and related ecological communities, including the habitat upon which the wildlife depends." (Fish & G. Code, § 89.5.) If "yes" is checked, submit the mapping or delineation. If the mapping or delineation is in digital format (e.g., GIS shape files or KMZ), you must submit the information in this format for CDFW to deem your notification complete. If "no" is checked, or the resolution of the mapping or delineation is insufficient, CDFW may request mapping or delineation (in digital or non-digital format), or higher resolution mapping or delineation for CDFW to deem the notification complete.

12. MEASURES TO PROTECT FISH, WILDLIFE, AND PLANT RESOURCES

A. Describe the techniques that will be used to prevent sediment, hazardous, or other deleterious materials from entering watercourses during and after construction.

Projects will take place during the dry season May 15 through Oct. 15. There will be no water present during work. No equipment will be used in stream or watercourse. Placement of the rip-rap will be done with a mini excavator from the road surface. The use of wattles or seed and straw to cover any exposed soil will prevent erosion.

Continued on additional page(s)

B. Describe project avoidance and/or minimization measures to protect fish, wildlife, and plant resources.

All work will be done during dry season. No vegetation will be removed. Natural riparian buffers will help to keep water temperatures low and reduce the possible potential of erosion. Any exposed soil will be seeded and strawed with native plant mix for erosion control.

Continued on additional page(s)

C. Describe any project mitigation and/or compensation measures to protect fish, wildlife, and plant resources.

By rip-rapping the outlet of the existing culvert, the potential for the water quality to improve downstream which will enhance fish populations in nearby Blue Slide Creek. --
 The armored crossing in place of a culvert on project 2 will also reduce the possible sediment discharge from the driveway.
 Any exposed or disturbed earth will be seeded and strawed to minimize potential erosion.

Continued on additional page(s)



13. PERMITS

List any local, State, and federal permits required for the project and check the corresponding box(es). Enclose a copy of each permit that has been issued.

A.	Humboldt County Cannabis Cultivation Permit	<input checked="" type="checkbox"/> Applied	<input type="checkbox"/> Issued
B.	SWQCB enrollment	<input checked="" type="checkbox"/> Applied	<input type="checkbox"/> Issued
C.		<input type="checkbox"/> Applied	<input type="checkbox"/> Issued
D. Unknown whether <input type="checkbox"/> local, <input checked="" type="checkbox"/> State, or <input type="checkbox"/> federal permit is needed for the project. (Check each box that applies)			
<input checked="" type="checkbox"/> Continued on additional page(s)			

14. ENVIRONMENTAL REVIEW

A. Has a <u>CEQA</u> lead agency been determined?		<input checked="" type="checkbox"/> Yes (Complete boxes B, C, D, E, and F)		<input type="checkbox"/> No (Skip to box 14.G)	
B. CEQA Lead Agency		Humboldt County Planning Dept.			
C. Contact Person		Steve Lazar		D. Phone Number	
				707-445-7245	
E. Has a draft or final document been prepared for the project pursuant to CEQA and/or NEPA?					
<input type="checkbox"/> Yes (Check the box below for each CEQA or NEPA document that has been prepared and enclose a copy of each.)					
<input type="checkbox"/> No (Check the box below for each CEQA or NEPA document listed below that will be or is being prepared.)					
<input type="checkbox"/> Notice of Exemption		<input type="checkbox"/> Mitigated Negative Declaration		<input type="checkbox"/> NEPA document (type): _____	
<input type="checkbox"/> Initial Study		<input checked="" type="checkbox"/> Environmental Impact Report			
<input type="checkbox"/> Negative Declaration		<input type="checkbox"/> Notice of Determination (Enclose)			
<input type="checkbox"/> THP/ NTMP		<input type="checkbox"/> Mitigation, Monitoring, & Reporting Plan			
F. State Clearinghouse Number (if applicable)					
G. If the project described in this notification is not the "whole project" or action pursuant to CEQA, briefly describe the entire project (Cal. Code Regs., tit. 14 § 15378).					
<input type="checkbox"/> Continued on additional page(s)					



H. Has a CEQA filing fee been paid pursuant to Fish and Game Code section 711.4?

Yes (Enclose proof of payment) No (Briefly explain below the reason a CEQA filing fee has not been paid)

Note: The CEQA filing fee is in addition to the notification fee. If a CEQA filing fee is required, the Lake or Streambed Alteration Agreement may not be finalized until paid.

15. SITE INSPECTION

Check one box only.

In the event CDFW determines that a site inspection is necessary, I hereby authorize a CDFW representative to enter the property where the project described in this notification will take place at any reasonable time, and hereby certify that I am authorized to grant CDFW such entry.

I request CDFW to first contact (insert name) Moriah Appel at (insert phone number or email address) 831-818-9928 to schedule a date and time to enter the property where the project described in this notification will take place. I understand that this may delay CDFW's determination as to whether a Lake or Streambed Alteration Agreement is required and/or CDFW's issuance of a draft agreement pursuant to this notification.

16. DIGITAL FORMAT

Is any of the information included as part of the notification available in digital format (i.e., CD, DVD, etc.)?

Yes (Please enclose the information via digital media with the completed notification form.)

No

17. SIGNATURE

I hereby certify that to the best of my knowledge the information in this notification is true and correct and that I am authorized to sign this notification as, or on behalf of, the applicant. I understand that if any information in this notification is found to be untrue or incorrect, CDFW may suspend processing this notification or suspend or revoke any draft or final Lake or Streambed Alteration Agreement issued pursuant to this notification. I understand also that if any information in this notification is found to be untrue or incorrect and the project described in this notification has already begun, I and/or the applicant may be subject to civil or criminal prosecution. I understand that this notification applies only to the project(s) described herein and that I and/or the applicant may be subject to civil or criminal prosecution for undertaking any project not described herein unless CDFW has been separately notified of that project in accordance with Fish and Game Code section 1602 or 1611.

 Signature of Applicant or Applicant's Authorized Representative

 Date

01/07/2020

 Diana Totten
 Print Name



Applicant Name: Moriah Appel

Project Name: Maggie

ATTACHMENT E

Commercial Cannabis Cultivation

Complete this attachment *if* the project includes commercial cannabis cultivation and you are seeking a standard Lake or Streambed Alteration Agreement or if activities include remediation of a cannabis cultivation site.

“Cultivation” means any activity involving the planting, growing, harvesting, drying, curing, grading, or trimming of cannabis (Business and Professions Code, section 26000 et seq.). *Please note that if you are seeking authorization under the General Agreement for Cannabis Cultivation you must notify online at the California Department of Fish and Wildlife (CDFW) website: <https://www.wildlife.ca.gov/Conservation/LSA/Notify-CDFW>.*

Complete Sections I through V and VII for all Agreement types.

Complete Section VI *if* any aspect of the project includes remediation. “Remediation” means to perform work that reduces or eliminates the direct and indirect adverse impacts on fish and wildlife resources associated with past or existing cannabis activities subject to Fish and Game Code 1602.

Submit Attachment E with the Notification form (DFW 2023) and applicable fees.

I. LOCAL JURISDICTION AUTHORIZATION – Complete this section for all Agreement types.

Does the town, city, or county where cultivation will occur have a rule, ordinance, or other regulation or law that governs the cultivation of cannabis?		
<input type="checkbox"/> Yes: Town/City	<input checked="" type="checkbox"/> Yes: County	<input type="checkbox"/> No
Are you required to have written authorization (permit) from the city/town and/or county to cultivate cannabis within the city/town and/or county?		
<input checked="" type="checkbox"/> Yes. <i>Enclose written authorization and/or completed application(s).</i>		<input type="checkbox"/> No

II. PROPERTY DIAGRAM – Complete this section for all Agreement types.

Enclose the cultivation Property Diagram that has been, or will be, submitted to the California Department of Food and Agriculture (CDFA) (California Code of Regulations, title 3, section 8105). For Property Diagram requirements, refer to http://calcannabis.cdfa.ca.gov/ , or CDFA’s Reference Guide for the Cultivation Plan .	
Cultivation Property Diagram enclosed?	
<input checked="" type="checkbox"/> Yes <i>Enclose the property diagram required by CDFA (Cal. Code Regs., tit. 3, § 8105).</i>	<input type="checkbox"/> No <i>If “no” is checked, enclose a brief description explaining why the property diagram is not enclosed.</i>



III. CULTIVATION OPERATION – Complete this section for all Agreement types.

Provide information regarding any pending cultivation license application or annual license CDFA has issued to the Entity, or that the Entity has applied or will apply for.

Type of Operation:

- Proposed new cannabis cultivation operation
 Existing cannabis cultivation operation

Premises APN(s):

*The Premises is the designated structure(s) and land specified in the CDFA application that are in possession of and used by the applicant to conduct the commercial cannabis activity. **Include ALL APNs associated with your CDFA application.***

221-221-009		

CDFA Annual or Provisional License # (if applicable): pending

CDFA Annual Application # (if license has not yet been issued): pending

State Water Resources Control Board – Cannabis Cultivation General Order

Water Discharge Identification (WDID) number: pending

Your WDID number can be found on the Notice of Applicability (NOA) issued to you by the Regional Water Quality Control Board.

IV. WATER SUPPLY – Complete this section for all Agreement types. Add additional pages as necessary.

How will or how is water supplied to the cannabis cultivation site(s)?

- *For geographic coordinates, provide the latitude and longitude coordinates for the water supply (if applicable). CDFW utilizes decimal degrees and WGS 84 datum. Access [Google Maps Help](#) if you need assistance in finding your coordinates.*

Diversion, Obstruction, Extraction, or Impoundment of a River, Stream, or Lake

- Yes No

*If yes is checked, you **must** also complete Attachment C.*

Provide geographic coordinates for **each** diversion, obstruction, extraction, or impoundment:

Latitude:	Longitude:
-----------	------------

Spring(s)

- Yes No

*If yes is checked, you **must** also complete Attachment C.*

Number of Springs _____

Provide geographic coordinates for **each** spring:

Latitude:	Longitude:
-----------	------------



Private Well(s)

Yes No

Provide geographic coordinates for each well:

Latitude:	Longitude:
-----------	------------

If a private well is being utilized, provide a copy of the well log/well completion report filed with the Department of Water Resources (DWR) pursuant to Section 13751 of Water Code. If no well log is available, provide evidence from DWR indicating that DWR does not have a record of the well log. See DWR's Groundwater Management page for more information at: <https://water.ca.gov/Programs/Groundwater-Management/Wells>

Public Water System

Yes No

Name of public water system: _____

If Yes, provide the most recent copy of water service bill or will-serve letter from the water service provider.

Water Hauling

Yes No

Name of water hauler: _____

Other Source

Specify: Rain Catchment

V. CALIFORNIA LICENSED PROFESSIONAL OR QUALIFIED ENVIRONMENTAL CONSULTANT/BIOLOGIST –
 Complete this section for all Agreement types.

Have you consulted with or retained a California licensed professional or qualified environmental consultant/biologist to address your cannabis cultivation?

Yes (Provide the information below) No

Name of Company	Name of Professional or Consultant/Biologist	Business Telephone
Clearwater Ag Services	Diana Totten	707-923-2767



VI. REMEDIATION – Complete this section if *any* aspect of the project includes remediation.

Remediation reduces or eliminates direct and indirect adverse effects on fish and wildlife resources associated with a past or existing project or activity that supports or relates to cannabis cultivation, whether on or off a cultivation site. Remediation projects typically include modification, repair, removal, restoration, construction, or reconstruction activities. Examples of remediation projects include, but are not limited to:

- Repairing a stream crossing used to access a cultivation site;
- Removing a staging area on a stream bank; and
- Repairing a water diversion structure used to irrigate a cultivation site.

A. Order or Notice. Are you required to perform remediation work described in this notification pursuant to a court or administrative agency notice or order?

- Yes (*Enclose a copy of the order or notice*) No

Did you receive a notice of violation (NOV) from CDFW that relates to the remediation work described in this notification?

- Yes (*Enclose a copy of the NOV*) No

B. Remediation Area. What is the amount of area requiring remediation?

Remediation area in total: _____ square feet

C. Remediation Plan. Has a plan to remediate the area been prepared?

- Yes (*Enclose the plan*) No

Note: If "yes" is checked, submit the remediation plan with the Notification. If "no" is checked, your Notification may be incomplete and CDFW may request you have a California licensed professional or qualified environmental consultant/biologist amend the plan or submit a new plan for your Notification.

VII. REMEDIATION FEES – Entity must pay the fee(s) at time of Notification.

The current fee schedule is available at <https://www.wildlife.ca.gov/Conservation/LSA> and specified in Section 699.5, subdivision (b) of the California Code of Regulations, title 14. Remediation fees, if applicable, are specified in Section 699.5, subdivision (i) of the California Code of Regulations, title 14. The remediation fee is in addition to the notification fee and must be submitted by **separate** check or other method of payment.

You may pay by credit card at CDFW's Online License Sales and Services page at: <https://www.wildlife.ca.gov/Licensing>. Attach copy of sales receipt to the notification. A handling charge will be applied (Fish and G. Code, § 1055.1, subd. (d)) to the credit card transaction.

Remediation Fee Included (if applicable)?

- Total remediation area identified in Section VI (B) above is less than or equal to 1,000 square feet
- Total remediation area identified in Section VI (B) above is greater than 1,000 square feet

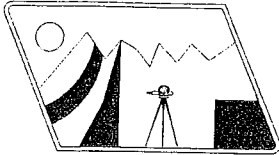

A.M. BAIRD

ENGINEERING & SURVEYING, INC.

1257 Main Street • P.O. Box 396 • Fortuna, CA. 95540 • (707) 725-5182 • Fax (707) 725-5581

CONSULTING - LAND DEVELOPMENT - DESIGN - SURVEYING

SOILS ENGINEERING

Geologic R-2

SOILS REPORT

PREPARED FOR

Moriah Appel

**APN: 221-221-009
7050 Crooked Prairie Rd.**



WHITETHORN, HUMBOLDT COUNTY, CA

PREPARED BY:

ALLAN M. BAIRD, RCE 23681

6/8/2020
Job# 20-4888

June 8, 2020

Building Official
County of Humboldt Building Department
3015 H Street
Eureka, California 95501

Humboldt County R2 Report: AP# 221-221-009
7050 Crooked Prairie Rd.
Whitethorn, CA
Client: Moriah Appel

INTRODUCTION

A.M. Baird Engineering has reviewed the above referenced lot near Whitethorn, California for a soils suitability report. This report is furnished to satisfy the soils criteria as required by Humboldt County for an "R2" Geological Report as pertaining to graded fill. Observations of this inspection regarding the site soils and topography are the contents of this report. A construction plan has not been reviewed by this office.

SITE LOCATION AND DESCRIPTION

Whitethorn is located between Redway and Shelter Cove on the Pacific Ocean some fifty-two air miles south-southeast of Eureka, and approximately sixteen road miles west-southwest of Redway. The site is on the westerly slopes of the Coast Range Mountains approximately 900 feet in elevation above the Pacific Ocean. The parcel is designated as APN 221-221-009 and is approximately 38.74 acres. Access to the parcel is provided via West Fork Road. This lot slopes south-southwest towards the Pacific Ocean from 10-40% in the vicinity of the graded area. See Enclosed Site Map.

SOIL CONDITIONS

Soil sampling within the excavation site on the parcel, labeled as TH1, revealed no discernable topsoil over at least 6-foot-thick subsoil. The subsoil is a dark brown Loam (Munsell color 10 YR 3/3), consisting of approximately 71% coarse weight. There is no indication in the surrounding area of any slumps, faults, or springs that would be detrimental to the building site.

GROUNDWATER

No groundwater or soil mottling was encountered during this soils investigation.

SLOPE STABILITY AND SURFACE DRAINAGE HAZARDS

The nature of the entire property appears to be stable and should remain stable provided the recommendations given in this report are followed. Areas disturbed during construction activities should be re-vegetated prior to the rainy season. Impermeable surfaces such as driveways and rooftops should be designed to uniformly diffuse runoff away from structures, and significant quantities of concentrated runoff should not be discharged over slopes greater than 20%.

GEOLOGICAL HAZARDS

This area of California is seismically very active and is subject to earthquakes of large magnitude, which can produce significant ground shaking. This moderate to very high level of risk of seismic hazard is typical for the northern coastal and inland areas.

This parcel is located within 2 miles of the Bricland Fault and within 8 miles of the Type A San Andreas Fault (north coast). In general, there are many sources of large magnitude earthquakes that could potentially affect this project area. These sources include but are not limited to the Garberville Fault, the Briceland Fault, the Lake Mountain Fault, the complex northwesterly oriented fault systems surrounding the Humboldt Bay area (including the Little Salmon, Mad River, Freshwater, and Gorda Fault Zones), and the Cascadia Subduction Zone near Cape Mendocino.

The San Andreas Fault has produced major earthquakes in this area at intervals of approximately 75-150 years. Earthquakes with average magnitudes of 5.8 occur on average every 10-15 years at varying locations in or near Humboldt County, and geological evidence suggests that the San Andreas Fault is capable of generating magnitudes much higher (7+). This high to very high level of risk of seismic hazard is typical for Northern California, and residents assume this risk when they choose to build in this area. Earthquakes capable of causing intense ground shaking and structural damage can be expected to occur within the design life of the proposed structure (40+ years). Residents should be aware of this inherent risk, and should understand that these risks cannot be fully eliminated with engineered design. As required, all structural design should be in conformance with the 2019 CBC Seismic Design Category (SDC) E (Section 1613A, 2019 CBC). Latitude and Longitude values were taken from the Humboldt County Web GIS website (County of Humboldt, 2019). Site-specific soil parameters were calculated using the USGS Ground Motion Parameter Calculator (Table 1) (USGS, 2019):

Latitude	40.1336
Longitude	-124.9623
Occupancy Category	II (normal buildings)
Importance Factor, I	1.0
Site Class	D (stiff soil) (default)
Site Coefficients	$F_a=1.0$
	$F_v=1.5$

Mapped Spectral Response Acceleration Parameters	$S_s = 1.773$ g (0.2-second spectral response)
	$S_1 = 0.898$ g (1-second spectral response)
Design Spectral Response Acceleration Parameters	$S_{MS} = 1.773$ g (0.2-second period)
	$S_{M1} = \text{null}$ - see section 11.4.8
Design Spectral Response Acceleration Parameters (five-percent damped design spectral response)	$S_{DS} = 1.182$ g (0.2-second period)
	$S_{D1} = \text{null}$ - see section 11.4.8
Seismic Design Category (SDC)	E ($S_1 > 0.75$ g)
Peak Ground Acceleration ($S_s/2.5$)	0.709

FLOOD HAZARDS

The site is not considered to be within a flood prone area. The hazard for flooding is considered low. It shall be noted however, that it is possible, though very unlikely that extreme flood events can alter stream courses enough to compromise nearby foundations and structures. This is considered a very low risk location.

EXISTING GRADING (CUT/FILL)

No evidence of other fill was apparent on the property during this site inspection, or is of sufficient age to be unrecognizable. The sub-soils are competent for foundation loads.

EARTHQUAKE MOTION HAZARDS

Slope instability, liquefaction, and surface rupture due exclusively to faulting or lateral spreading are not considered consequential as to require specific analysis. Peak ground acceleration for design purposes shall be $S_s/2.5$ according to ASCE 7-16 Section 11.8.3 unless additional site-specific analysis is provided beyond the scope contained herein.

RECOMMENDATIONS

No expansive soils were encountered during this investigation that require specific recommendations. The undisturbed soil on this lot can support a load of 1,500 pounds per square foot (psf). The soil is suitable for grading uses for this site, and settlement is not anticipated to be detrimental provided considerations are given to the recommendations presented herein:

Monitoring and Inspection

Sites will be monitored daily during wet weather by contractor and/or owner(s). Contractor and/or owner(s) are responsible for reporting any hazardous situations to the engineer. Upon completion of the permitted grading work and at the final completion of the work for "engineered grading" or when professional inspection is performed for regular grading a final report shall be submitted by the engineer if required. The permit applicant/owner(s) shall notify the building official when the grading operation is ready for final inspection.

Cut Slopes

1. **Cut Slope.** The slope of cut surfaces shall be no steeper than is safe for the intended use and shall be no steeper than one-unit vertical in two-units horizontal (50% slope)
 - 1.1.1. **Exemptions:** cut surface shall be remitted to a max slope of one and a half units horizontal to one-unit vertical (67%) slope if all the following are met
 - 1.1.2. It is not intended to support structures or surcharges
 - 1.1.3. It is adequately protected against erosion
 - 1.1.4. It is no more than eight feet in height
 - 1.1.5. It is approved by the building code office
 - 1.1.6. Groundwater is not encountered
 - 1.1.7. A cut surface in bedrock shall be permitted to be at a slope of one unit horizontal to one unit vertical

Fill Slope and Preparation

1. **Preparation of Ground.** Fill slopes shall not be constructed on natural slopes steeper than one-unit vertical in two-units horizontal (50% slope). The ground surface shall be prepared to receive fill by removing vegetation, non-complying fill, topsoil and other unsuitable materials scarifying to provide a bond with the new fill and, where slopes are steeper than one-unit vertical in five-units horizontal (20% slope) and the height is greater than five-feet (1.52 m), by benching unless specified in a report from this office. The bench under the toe of a fill on a slope steeper than one-unit vertical in five-units horizontal (20% slope) shall be at least ten-feet (3.05 m) wide. The area beyond the toe of fill shall be sloped for sheet overflow or a paved drain shall be provided. When fill is to be placed over a cut, the bench under the toe of fill shall be at least ten feet (3.05 m) wide but the cut shall be made before placing the fill.
2. **Fill Material.** Amounts of organic material detrimental to structural integrity shall not be permitted in fills. Except as permitted by the building official, no rock or similar irreducible material with a maximum dimension greater than 12 inches (0.31 m) shall be buried or placed in fills

3. **Compaction.** All fills shall be compacted to achieve an equivalent minimum of 90 percent of maximum dry density with enough testing for documentation of compliance with this standard. Fill slops shall be placed in max 8-12" lifts and compacted. If the graded areas are attended for permanent structures requiring foundations, fill should be placed in lifts and compacted to 95% with testing.
4. **Slope.** The slope of fill surfaces shall be no steeper than is safe for the intended use. Fill slopes shall be no steeper than one-unit vertical in two-units horizontal (50% slope).

Setbacks

1. **General.** Cut and fill slopes shall be set back from site boundaries in accordance with this section. Setback dimensions shall be horizontal distances measured perpendicular to the site boundary.
2. **Top of Cut Slope.** The top of cut slopes shall not be made nearer to a site boundary line than one fifth of the vertical height of cut with a minimum of two feet (0.61 m) and a maximum of ten feet (3.05 m). The setback may need to be increased for any required interceptor drains.
3. **Toe of Fill Slope.** The toe of fill slope shall be made not nearer to the site boundary line than one half the height of the slope with a minimum of two feet (0.6 m) and a maximum of 20 feet (6.1 m). Where a fill slope is to be located near the site boundary and the adjacent offsite property is developed, special precautions shall be incorporated in the work as the building official deems necessary to protect the adjoining property from damage as a result of such grading. These precautions may include but are not limited to: (1) Additional setbacks. (2) Provision for retaining, or slough walls. (3) Mechanical or chemical treatment of the fill slope surface to minimize erosion. (4) Provisions for the control of surface waters.

Drainage and Terracing for Slopes Steeper Than 33%

1. **General.** Unless otherwise indicated on the approved grading plan, drainage facilities and terracing shall conform to the provisions of this section for cut or fill slopes steeper than one-unit vertical in three-units horizontal (33.3% slope).
b. Hill Terrace. Terraces at least six feet (1.83 m) in width shall be established at not more than 30-foot (9.14 m) vertical intervals on all cut or fill slopes to control surface drainage and debris except that where only one terrace is required, it shall be at mid-height. For cut or fill slopes greater than 60 feet (18.29 m) and up to 120 feet (36.58 m) in vertical height, one terrace at approximately mid-height shall be 12 feet (3.66 m) in width. Terrace widths and spacing for cut and fill slopes greater than 120 feet (36.58 m) in height shall be designed by the civil engineer and approved by the building official. Suitable access shall be provided to permit proper cleaning and maintenance. Swales or ditches on terraces shall have a minimum gradient of five percent and must be paved with reinforced concrete not less than three inches (76 mm) in thickness or an approved equal paving as approved by the building official. They shall have a minimum depth at the deepest point of 12 inches (305 mm) and a minimum paved width of five feet (1.52 m). A single run of swale or ditch shall not collect runoff from a tributary area exceeding 13,500 square feet (1254.2 m²) (projected) without discharging into a down drain. Unless otherwise noted
2. **Drainage Across Property Line.** Drainage across property lines shall not exceed that which existed prior to grading. Excess or concentrated drainage shall be contained on site or directed to an approved drainage facility. Erosion of the ground

in the area of discharge shall be contained onsite or directed to an approved drainage facility. Erosion of the ground in the area of discharge shall be prevented by installation of non-erosive down drains or other devices.

3. **Subsurface Drainage.** Cut and fill slopes shall be provided with subsurface drainage as necessary for stability.
4. **Surface Drainage Disposal.** All drainage facilities shall be designed to carry waters to the nearest practicable drainageway approved by the building official or other appropriate jurisdiction as a safe place to deposit such waters. Erosion of ground in the area of discharge shall be prevented by installation of non-erosive down drains or other devices. Building pads shall have a drainage gradient of two percent toward approved drainage facilities, unless waived by the building official. The gradient from the building pad may be one percent if all the following conditions exist throughout the permit area: (1) No proposed fills are greater than 10 feet (3.05 m) in maximum depth. (2) No proposed finished cut or fill slope faces have a vertical height in excess of 10 feet (3.05 m). B - 14 (3) No existing slope faces, which have a slope face steeper than one-unit vertical in ten-units horizontal (10% slope), have a vertical height in excess of ten feet (3.05 m).

Interceptor Drains.

1. Interceptor drains shall be installed along the top of cut slopes receiving drainage from a tributary width greater than 40 feet. The 40 feet should be measured horizontally, they shall have a minimum depth of one foot and a minimum width of three feet.
2. Paved interceptor drains shall be installed along the top of all cut slopes where the tributary drainage area above slopes toward the cut and has a drainage path greater than 40 feet (12.19 m) measured horizontally. Interceptor drains shall be paved with a minimum of three inches (76 mm) of concrete or gunite and reinforced. They shall have a minimum depth of 12 inches (305 mm) and a minimum paved width of 30 inches (762 mm) measured horizontally across the drain. The slope of drain shall be approved by the building official.

Erosion and Sedimentation Control.

1. **General** These standards shall be incorporated into the project design and shall be adhered to during project construction:
2. Minimize soil exposure during the rainy season by proper timing of grading and construction.
3. Retain trees and natural vegetation to stabilize hillsides, retain moisture, reduce erosion, minimize siltation and nutrient runoff and preserve scenic qualities.
4. Vegetate and mulch denuded areas to protect them from winter rains.
5. Divert runoff away from steep, denuded slopes or other critical areas with barriers, berms, ditches or other facilities.
6. Design grading to be compatible with adjacent areas and result in minimal disturbance of the terrain and natural land features.
7. Limit construction, clearing of vegetation and disturbance of the soil to areas of proven stability. Mitigate geologic hazards and adverse soil conditions when they are encountered. Reduce sediment transport off the site to the maximum extent feasible using Best Management Practices (BMPs).

8. Propose a new or modified erosion and sediment control technique if the technique is preferred and meets the intent of these regulations. Obtain approval from the County prior to implementation.
9. If construction is to occur between October 15th and April 15th site inspections will be conducted by the contractor and/or owner(s) prior to a forecasted storm, after a rain even, weekly throughout the rainy season, and every two weeks throughout construction
10. Conduct frequent site inspections to ensure that control measures are working properly and to correct problems as needed.

Sediment Control

1. Use sediment basins, silt traps, or similar measure to retain sediment transported by runoff water onsite.
2. Collect and direct surface runoff at non-erosive velocities to the common natural watercourse of the drainage area.
3. Avoid concentrating surface water anywhere except swales or watercourses.
4. Prevent mud from being tracked onto the public roadway by traveling over a temporary gravel construction entrance or washing off vehicle tires before entering a public or private driveway.

Slope Construction

1. Minimize length and steepness of slopes by benching, terracing or constructing diversion structures.
2. Preserve, match, or blend cuts and fills with the natural contours and undulations of the land.
3. Round sharp angles at the top and sides of cut and fill slopes.
4. Maintain cut and fill slopes at less than two-to-one (2V:1H,) slope unless a geological and engineering analysis indicates that steeper slopes are safe, and erosion and sediment control measures can successfully prevent erosion.
5. Where a cut or fill slope occurs between two lots, make the slope a part of the downhill lot if possible.

Protection of Watercourses and Drainage Inlets

1. Prepare drainageways to handle concentrated or increased runoff from disturbed areas by using appropriate lining materials or energy absorbing devices to reduce the velocity of runoff water.
2. Trap sediment-laden runoff in basins to allow soil particles to settle out before flows are released to receiving waters, storm drains, streets or adjacent property. This standard is not mandatory for grading conducted between April 15 and October 15 and when the site is fully winterized and stabilized prior to October 15. Remove trapped sediment to a suitable location on-site or at a disposal site approved by the County.
3. Do not grade or drive equipment in a Streamside Management or Other Wet Areas except as allowed through the County Streamside Management Area Ordinance.
4. Deposit or store excavated materials away from watercourses.
5. Protect all existing or newly installed storm drainage structures from sediment clogging.

6. Use straw bales, filter fabric wraps and drainage inlet protections in a manner that does not cause additional erosion or flooding of a roadway.

Dust Control

1. All construction areas, including disposal sites, shall be treated and maintained as necessary to minimize the emission of dust. Maintenance shall be conducted as necessary to prevent a nuisance to offsite properties.
2. All construction sites, including driveways, shall be maintained as necessary to minimize the emission of dust and prevent the creation of a nuisance to adjacent properties.

Revegetation

1. Apply temporary seeding and mulching to denuded areas prior to October 15 unless the project is conditioned otherwise.
2. Establish a permanent vegetative cover on denuded areas not otherwise stabilized. Permanent vegetation ground cover must control soil erosion satisfactorily and survive severe weather conditions.
3. Retain a vegetative barrier whenever possible around property boundaries.
4. Use self-sustaining, non-invasive plants that require little or no maintenance and do not create an extreme fire hazard.
5. Use native plant species whenever feasible.

FOUNDATION RECOMMENDATIONS

- 1) Foundations for any residence should be reinforced and be contained in firm, undisturbed native soil. If the foundation is going to be set into fill, the fill must be compacted to 95% compaction rating verified by testing. The fill must be laid in 0.5' lifts and each lift must be tested for the required compaction percentage. The subsoil seen at 1.6 feet is the target load bearing subsoil. The foundation should be extended into the load bearing soil a minimum one foot for a single story, one and a half feet for a two-story, and two feet for three-story structure. Spread footings and foundation walls should be reinforced and be at minimum 15" wide for one-story structures, 18" wide for two-story structures, and 24" for three-story structures. Foundation walls should be a minimum of seven and a half inches thick for single-story structures, a minimum of eight inches for two-story structures, and a minimum of ten inches for three-story structures. Foundation footings shall be setback a minimum of 25 feet from any slopes dropping over 50%. Foundation footings shall be setback a minimum distance of four feet from bottom of footing as measured horizontally to daylight from slopes dropping over 30%. Foundation footing setbacks to slope breaks shall comply with specifications in Section 1808.7 and Figure 1808.7.1 (shown below) of the 2019 CBC (as specified in recommendation #1).

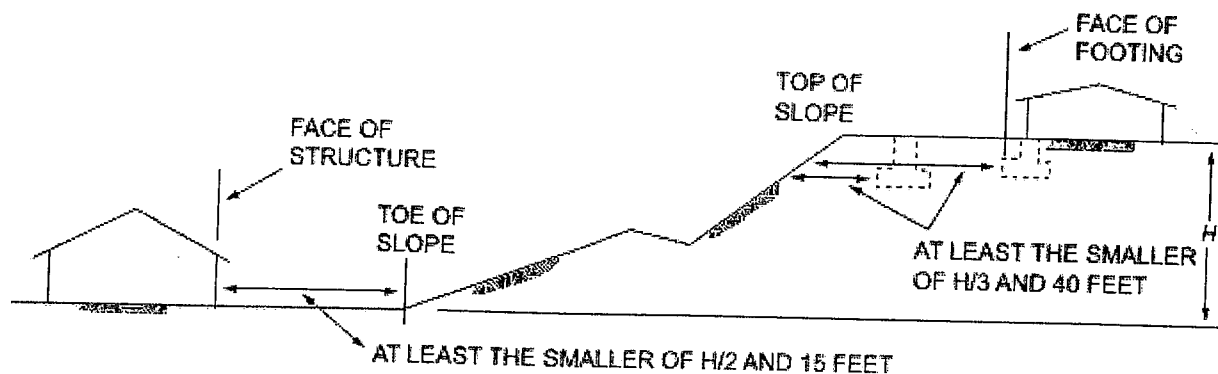

- 2) All surface runoff from developed or paved areas of the lot should be controlled to flow and drain away or be routed in such a manner as to not affect slope stability or the integrity of the foundation soil. Erosion control dissipation devices shall be installed at all locations where water is discharged over slopes greater than 20%.
- 3) All excavation shall be completed in conformance with Section 1804 of the 2019 CBC. Additionally, earthwork grading/excavation shall be conducted during the dry season, unless constructed in conformance with a grading and erosion control plan and with Humboldt County codes and the recommendations in this report.
- 4) All existing and proposed fill and cut slopes are to be re-vegetated to prevent erosion. This is to be done to the satisfaction of local building officials. Existing vegetation beyond the construction area should be left undisturbed if feasible.
- 5) If cutting or grading is to be done at a depth greater than 5 feet, it is recommended that this office be contacted for specific comments and recommendations. Cut and fill under 5 feet should be limited to 2V:1H max slope.
- 6) Gutters are to extend along all rooflines and lead to down spouts. In turn, down spouts should lead to pipes carrying roof runoff away from the building site, as well as any fill or foundations that may adversely affect the site soil or adjacent slopes.
- 7) Floor slabs should be reinforced by #3 reinforcing bars at 18" o.c. or #4 reinforcing bars at 24" o.c. each way and be underlain by at least 4" of class 2 aggregate bases with limited fines to act as a capillary moisture break and a vapor barrier. The vapor barrier shall be in direct contact with concrete. Contractor and owner are responsible for determining the extent of waterproofing methods necessary and implementing the appropriate measures as described in recommendation #9 and shall be aware of the current recommendations and guidelines for slabs below grade according to the American Concrete Institute.
- 8) All foundation design and construction shall be in conformance with Chapter 18 of the 2019 CBC. All footings are to meet local requirements for seismic criteria, as required by the 2019 CBC. Seismic design parameters have been included in this report based on latitude and longitude values taken from the Humboldt County Web GIS website (County of Humboldt, 2020).

- 9) Any floor space at or below existing grade level that will be used as inhabitable areas or for storage shall be appropriately dampproofed or waterproofed as described in Section 1805 of the 2019 CBC. These appropriate measures at minimum will constitute installation of 6-mil vapor barrier or equivalent against the foundation or retaining wall, along with drain rock a minimum of 12" thick to the bottom of the footing and made to drain by four inch perforated pipe tight-lines to daylight away from the foundation soils. It is recommended that slabs below grade used for living space be underlain with a minimum of six inches of open graded aggregate instead of four inches as described in recommendation #7 for an increased protection from capillary water infiltration. Additional or superior measures may include installation of sub-slab drainage pipes or geo-textile membranes and should be installed according to current standards of practice.

CLOSURE

Based upon the review conducted by this office of the site and surrounding terrain no further geological evaluation is required; therefore, no geotechnical engineer consultation is warranted. This office shall be contacted if subsurface conditions differ significantly from those stated in this report, or if further investigation or inspection is requested by involved agencies.

It has been assumed that observed soils are representative of the entire subsurface conditions on the property in question. If it is found during construction that subsoil conditions differ from those described, the conclusions and recommendations of this report should be considered invalid unless the changes are reviewed and the conclusions and recommendations are modified or approved in writing. This analysis was conducted in accordance with the standards maintained by professionals in the engineering field, and the findings presented herein are reasonably representative of site conditions and probable site behavior based on this investigation. Due to the inexact nature of many engineering analyses, including those employed during the preparation of this report, there is no guarantee or warranty expressed or implied. Enclosed in this report are site maps, Assessor's Parcel Maps, and geologic maps as referenced.

If you have any questions regarding this report, or to schedule an inspection, please feel free to contact this office at (707) 725-5182.

Sincerely,

Allan M. Baird
Principal, RCE# 23681



References

- American Society of Civil Engineering (ASCE). (2016). *Minimum Design Loads for Buildings and Other Structures*. ASCE/SEI 7-10.
- California Department of Conservation, Division of Mines and Geology. (1998). *Maps of Known Active Fault Near-Source Zones in California and Adjacent Portions of Nevada*. International Conference of Building Officials. Whittier, CA.
- County of Humboldt. (2020). *Humboldt County Web GIS Planning and Building Mapping*. Available Online
[<http://gis.co.humboldt.ca.us/Freeance/Client/PublicAccess1/index.html?appconfig=podgis>]
- Part 2. California Building Code (2019) Volume 2 (Chapters 16-34):
https://codes.iccsafe.org/content/document/1007?site_type=public
- United States Geological Survey (USGS). (2020). *U.S. Seismic Design Maps*. Available Online [<https://earthquake.usgs.gov/designmaps/us/application.php?>].
- Title III, Land Use and Development Division 3. Building Regulations Section 331-12. Grading, Excavation, and Erosion Control and Sedimentation Ordinance (Humboldt County). (2020).
- "U.S. Seismic Design Maps." U.S. Seismic Design Maps, SEAOC/OSHPD, 2020, seismicmaps.org/.



OSHPD

Latitude, Longitude: 40.1336, -123.9623



Blue Slide Creek Rd

Map data ©2020

Google

Date	6/5/2020, 3:56:15 PM
Design Code Reference Document	ASCE7-16
Risk Category	II
Site Class	D - Stiff Soil

Type	Value	Description
S_S	1.773	MCE_R ground motion. (for 0.2 second period)
S_1	0.898	MCE_R ground motion. (for 1.0s period)
S_{MS}	1.773	Site-modified spectral acceleration value
S_{M1}	null -See Section 11.4.8	Site-modified spectral acceleration value
S_{DS}	1.182	Numeric seismic design value at 0.2 second SA
S_{D1}	null -See Section 11.4.8	Numeric seismic design value at 1.0 second SA

Type	Value	Description
SDC	null -See Section 11.4.8	Seismic design category
F_a	1	Site amplification factor at 0.2 second
F_v	null -See Section 11.4.8	Site amplification factor at 1.0 second
PGA	0.797	MCE_G peak ground acceleration
F_{PGA}	1.1	Site amplification factor at PGA
PGA_M	0.877	Site modified peak ground acceleration
T_L	12	Long-period transition period in seconds
S_{sRT}	2.253	Probabilistic risk-targeted ground motion. (0.2 second)
S_{sUH}	2.486	Factored uniform-hazard (2% probability of exceedance in 50 years) spectral acceleration
S_{sD}	1.773	Factored deterministic acceleration value. (0.2 second)
S_{1RT}	0.947	Probabilistic risk-targeted ground motion. (1.0 second)
S_{1UH}	1.058	Factored uniform-hazard (2% probability of exceedance in 50 years) spectral acceleration.
S_{1D}	0.898	Factored deterministic acceleration value. (1.0 second)
PGA_d	0.797	Factored deterministic acceleration value. (Peak Ground Acceleration)
C_{RS}	0.906	Mapped value of the risk coefficient at short periods
C_{R1}	0.895	Mapped value of the risk coefficient at a period of 1 s

40.1336, -123.9623 X Q

Show search results for 40.1336, -12...

Redwood
Slate Park

Myers Flat

85

KING RANGE
KING RANGE

APN: 221-221-009

King
Range National
Conservation
Area

88

THRUST
ZONE

1906

87

WHALE GULCH F

BRICELAND

GARBERVILLE
FAULT

79

FLT. Redwood

Garberville

GIBSON
RIDGE

HUMBOLDT
MENDOCINO

Richardson
Cove
State Park

4mi

-123.772 40.147 Degrees

Project: Appel
 Hole #: 1

Logged by: MN Jn# 19-4888
 Date: 10/15/2019 Excavation: Hand

SUBSURFACE PROFILE LOGS

Description & Remarks	Depth (ft)	Sample	Classification
0-2 ft	-		
Gradual boundary (2-10')	-		
Munsell color 10 YR 3/3 dark brown	-		
Very gravelly: (35-65%), Birds Eye - 1.5"	-		
Structure: Single grain, granular	- 1 -		
Consistence:	-		
moist: very friable	-		ZONE 2
wet: slightly sticky	-		Sandy Loam
No roots	- 2 -		
Pores:	-		
Common: fine (10-50), medium (1-5)	-		
NO MOTTLING	-		
NO GROUNDWATER OBSERVED	- 3 -		
End of excavation	-		
	-		
	-		
	- 4 -		
	-		
	-		
	- 5 -		
	-		
	-		
	- 6 -		
	-		
	-		
	- 7 -		
	-		
	-		
	- 8 -		
	-		
	-		
	- 9 -		
	-		
	-		
	- 10 -		
	-		
	-		
	- 11 -		

PROFILES LOGS SHOW SUBSURFACE CONDITIONS BY OBSERVATIONS AT THE DATES AND LOCATIONS INDICATED AND IT IS NOT WARRANTED THAT THEY ARE REPRESENTATIVE OF SUBSURFACE CONDITIONS AT OTHER LOCATIONS AND TIMES.

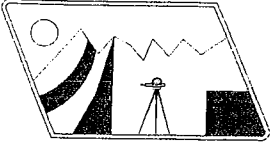

A.M. BAIRD

ENGINEERING & SURVEYING, INC.

1257 Main Street • P.O. Box 396 • Fortuna, CA. 95540 • (707) 725-5182 • Fax (707) 725-5581

CONSULTING - LAND DEVELOPMENT - DESIGN - SURVEYING

Project: Appel

by: BIV

AP#: 221-221-009

Lab Test Date: 6/8/2020

1	SAMPLE NUMBER
1	TEST HOLE
2+	Depth (ft)
864	TOTAL SAMPLE WEIGHT (gm)
614	Coarse Weight (gm)
75	A. Owendry Weight (gm)
8:18	B. Starting Time (hr:min:sec)
68.3	C. Temp @ 40 sec. (°F)
35	D. Hydrometer Reading @ 40 sec. (gm/l)
-6.44	E. Composite Correction (gm/l)
28.56	F. True Density @ 40sec. (gm/l), (D-E)
68.7	G. Temp @ 2 hrs. (°F)
21	H. Hydrometer Reading @ 2hrs. (gm/l)
-6.36	I. Composite Correction (gm/l)
14.64	J. True Density @ 2 hrs. (gm/l), (H-I)
61.9	K. % Sand = $100 - [(F/A) \times 100]$
19.5	L. % Clay = $(J/A) \times 100$
18.6	M. % Silt = $100 - (K + L)$
Sandy Loam	N. USDA Texture
2	O. Soil Percolation Suitability Chart Zone
38.1	P. Combined % Silt and Clay
71.1	Q. Coarse % by weight
11.2	R. % Coarse Adjustment*

* [(.2)(.00003Q^3+.0006Q^2+.5968Q-.0941)]

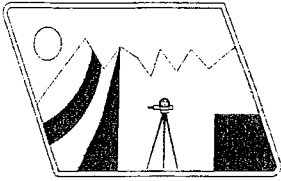

A.M. BAIRD

ENGINEERING & SURVEYING, INC.

1257 Main Street • P.O. Box 396 • Fortuna, CA. 95540 • (707) 725-5182 • Fax (707) 725-5581

CONSULTING - LAND DEVELOPMENT - DESIGN - SURVEYING

CLIENT: Appel

DATE: 6/9/2020

APN: 221-221-009

BLOCK/LOT: NA

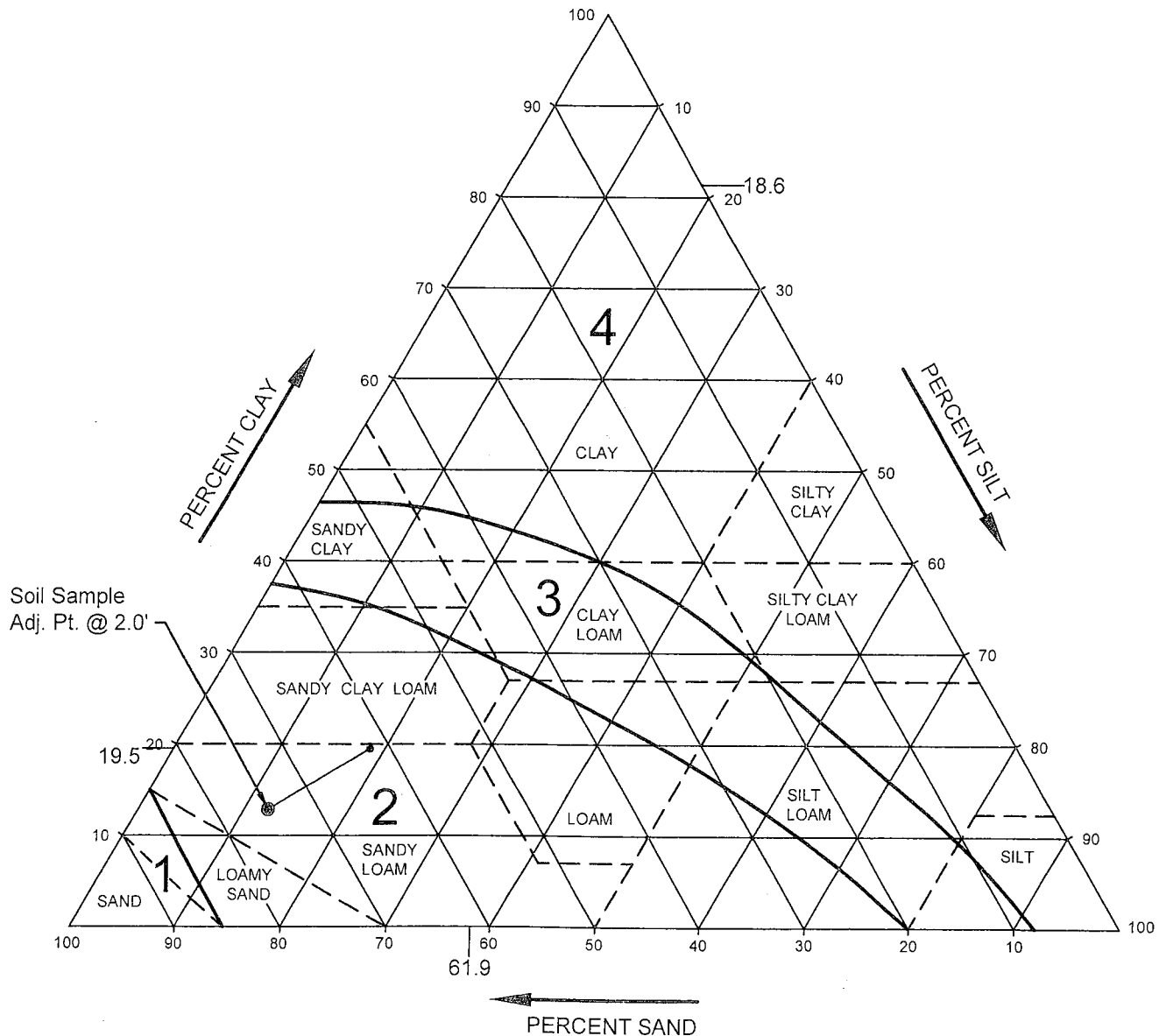

1. COARSE ADJUSTMENT: Soil Sample @ 2" = 11.2%

GRADING NOTES:

1. NO KNOWN EASEMENTS.
2. NO TREES TO BE REMOVED
3. APPROXIMATELY 500 CU. YDS. OF EXCAVATION OCCURRED INCREMENTALLY OVER SEVERAL YEAR:
4. GRADING OF THIS PROJECT IS NOT GREATER THAN 500 CU. YDS. AND SHALL BE DESIGNATED "MINOR GRADING"
5. ALL FILL MATERIAL SHALL NOT CONTAIN ANY IR MATERIAL (ROCK) GREATER THAN 12" DIAMETER CONTAIN AMOUNTS OF ORGANIC MATERIAL DETR THE STRUCTURAL INTEGRITY OF THE FILL
6. THE EEL RIVER IS LOCATED SOUTH OF THE SOU PROPERTY BOUNDARY, APPROX. 700 FEET SOUT OF THE FILL LOCATION.
7. NO KNOWN HAZARDOUS OR SENSITIVE AREAS. N HISTORICAL BUILDINGS OR ARCHAEOLOGICAL OR PALEONTOLOGICAL RESOURCES

DIRECTIONS TO SITE:

FROM EUREKA, TRAVEL 60 MILES SOUTH ON HWY. 101 TO REDWOOD DR. TRAVEL 2 MILES TO BRICELAND RD. ON RIGHT. TRAVEL 12.4 MILES TO ETTERSBURG RD. ON RIGHT, THEN AFTER 1 MILE TAKE SHARP LEFT TO BLUE SLIDE CREEK RD. AFTER 1.4 MILES, TURN RIGHT ON CROOKED PRAIRIE RD. DRIVEWAY IS 0.3 MILES ON LEFT.

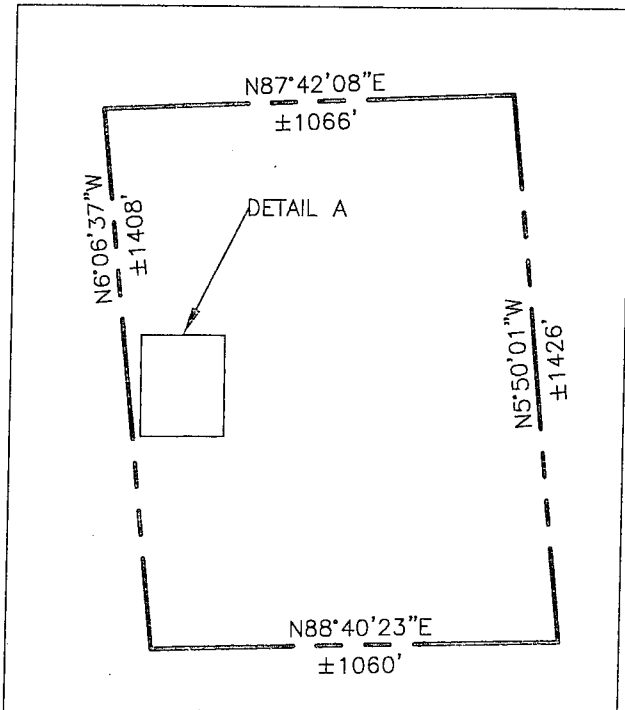

PARCEL OUTLINE

1"=500'

FEET
60



PROJECT INFORMATION

AS-BUILT GRADING
GRADING & EROSION PLAN

OWNER:

MORIAH APPEL
P.O. BOX 616
WHITETHORN, CA 95589

SITE ADDRESS:

7050 CROOKED PRAIRIE RD.
WHITETHORN, CA

TOTAL AREA: 38.74 ACRES

PARCEL:

PARCEL NUMBER:
221-221-009

VE LEGEND

- — — — — PROPERTY BOUNDARY
- - - - - EDGE OF ROADWAY
- — — — — ROAD CENTERLINE
- — — — — 2' CONTOUR LINES
- FR — — — FIBER ROLL

MAPPING INFORMATION PROVIDED IS FOR SITE DESIGN PURPOSES ONLY. THIS SITE PLAN REFLECTS MANY MAPPING DETAILS THAT ARE USEFUL TO ASSURE THAT THE SITE FACILITIES ARE LOCATED APPROPRIATE TO THE SURROUNDINGS. HOWEVER, NONE OF THE INFORMATION SHOWN IS IMPLIED TO SUGGEST OR SUBSTITUTE FOR A CONTRACTED ACTUAL LAND SURVEY. A. M. BAIRD, ENGINEERING AND SURVEYING, INC. ASSUMES NO RESPONSIBILITY ARISING FROM THE USE OF INFORMATION PROVIDED, OTHER THAN WHAT HAS BEEN SPECIFICALLY INTENDED FOR THE SITE DESIGN.

NO.	DATE	DESCRIPTION	BY

A.M. Baird
Engineering & Surveying
1257 Main St., P.O. Box 396, Fortuna, CA 95540, (707)725-5182

SCALE	AS SHOWN
DRAWN BY	MLR
CHKD	A.M.B.
DATE	6/1/2020

MORIAH APPEL
AP # 221-221-009
7050 CROOKED PRAIRIE RD, WHITETHORN, CA
AS-BUILT GRADING
SITE PLAN

GRADING NOTES:

1. NO KNOWN EASEMENTS.
2. NO TREES TO BE REMOVED
3. APPROXIMATELY 500 CU. YDS. OF EXCAVATION OCCURRED INCREMENTALLY OVER SEVERAL YEAR:
4. GRADING OF THIS PROJECT IS NOT GREATER THAN 500 CU. YDS. AND SHALL BE DESIGNATED "MINOR GRADING"
5. ALL FILL MATERIAL SHALL NOT CONTAIN ANY IR MATERIAL (ROCK) GREATER THAN 12" DIAMETER CONTAIN AMOUNTS OF ORGANIC MATERIAL DETR THE STRUCTURAL INTEGRITY OF THE FILL
6. THE EEL RIVER IS LOCATED SOUTH OF THE SOU PROPERTY BOUNDARY, APPROX. 700 FEET SOUT OF THE FILL LOCATION.
7. NO KNOWN HAZARDOUS OR SENSITIVE AREAS. N HISTORICAL BUILDINGS OR ARCHAEOLOGICAL OR PALEONTOLOGICAL RESOURCES

DIRECTIONS TO SITE:

FROM EUREKA, TRAVEL 60 MILES SOUTH ON HWY. 101 TO REDWOOD DR. TRAVEL 2 MILES TO BRICELAND RD. ON RIGHT. TRAVEL 12.4 MILES TO ETTERSBERG RD. ON RIGHT, THEN AFTER 1 MILE TAKE SHARP LEFT TO BLUE SLIDE CREEK RD. AFTER 1.4 MILES, TURN RIGHT ON CROOKED PRAIRIE RD. DRIVEWAY IS 0.3 MILES ON LEFT.

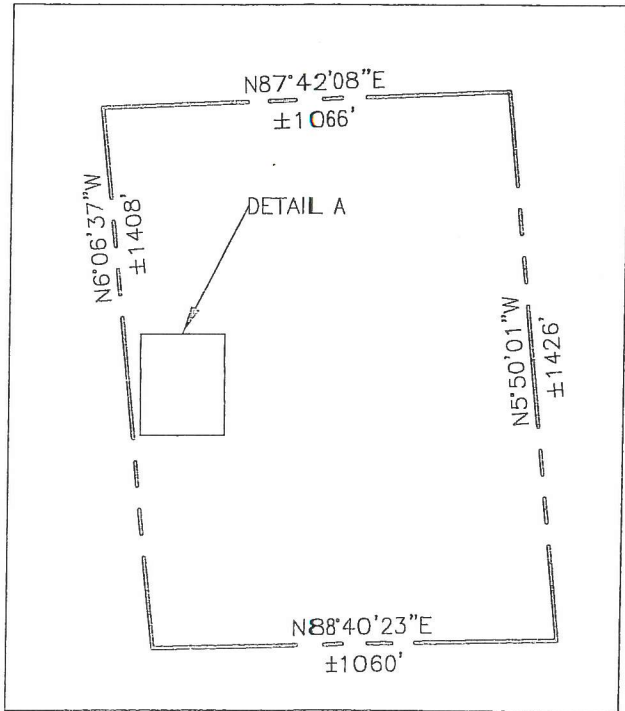

PARCEL OUTLINE

1" = 500'

PROJECT INFORMATION

AS-BUILT GRADING
GRADING & EROSION PLAN

OWNER:
MORIAH APPEL
P.O. BOX 616
WHITETHORN, CA 95589

SITE ADDRESS:
7050 CROOKED PRAIRIE RD.
WHITETHORN, CA

TOTAL AREA: 38.74 ACRES

PARCEL:
PARCEL NUMBER:
221-221-009

NE LEGEND

PROPERTY BOUNDARY
 EDGE OF ROADWAY
 ROAD CENTERLINE
 2' CONTOUR LINES
 FR FIBER ROLL

MAPPING INFORMATION PROVIDED IS FOR SITE DESIGN PURPOSES ONLY. THIS SITE PLAN REFLECTS MANY MAPPING DETAILS THAT ARE USEFUL TO ASSURE THAT THE SITE FACILITIES ARE LOCATED APPROPRIATE TO THE SURROUNDINGS. HOWEVER, NONE OF THE INFORMATION SHOWN IS IMPLIED TO SUGGEST OR SUBSTITUTE FOR A CONTRACTED ACTUAL LAND SURVEY. A. M. BAIRD, ENGINEERING AND SURVEYING, INC. ASSUMES NO RESPONSIBILITY ARISING FROM THE USE OF INFORMATION PROVIDED, OTHER THAN WHAT HAS BEEN SPECIFICALLY INTENDED FOR THE SITE DESIGN.

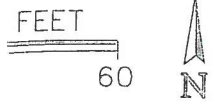

	BY
	REVISIONS
	DESCRIPTION
	DATE
	NO.
<p style="font-size: 1.2em; font-weight: bold;">A.M. Baird</p> <p>Engineering & Surveying</p> <p style="font-size: 0.8em;">1257 Main St., P.O.Box. 398, Fortuna, CA 95540, (707)725-5182</p>	
SCALE	AS SHOWN
DRAWN BY	ERT
CHKD	ALB.
DATE	01/20/20
<p>MORIAH APPEL AP# 221-221-009 7050 CROOKED PRAIRIE RD, WHITETHORN, CA</p> <p>AS-BUILT GRADING SITE PLAN</p>	
JOB NO. 20-488B	
SHEET NO. 1 OF 1	

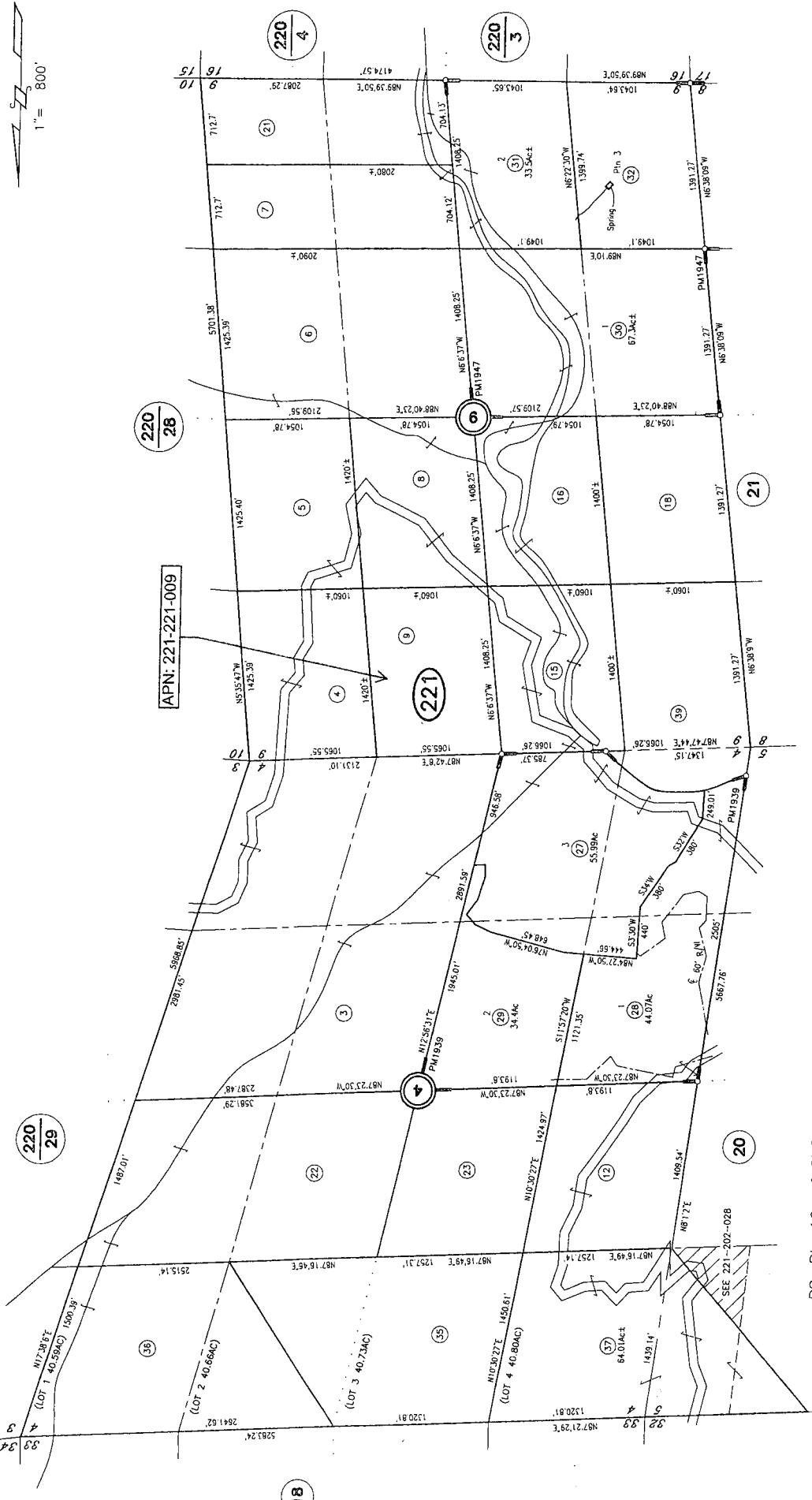

- RS, Bk. 10, of SURVEYS Pg. 83
- RS, Bk. 22, of SURVEYS Pgs. 66-69
- RS, Bk. 22, of SURVEYS Pg. 74
- RS, Bk. 22, of SURVEYS Pgs. 121-124
- RS, Bk. 23, of SURVEYS Pg. 1
- RS, Bk. 23, of SURVEYS Pg. 21
- RS, Bk. 23, of SURVEYS Pg. 31
- RS, Bk. 23, of SURVEYS Pg. 93
- RS, Bk. 24, of SURVEYS Pgs. 9-10
- RS, Bk. 24, of SURVEYS Pg. 84
- RS, Bk. 26, of SURVEYS Pg. 11
- PM62, Bk. 1 of PM Pg. 91
- PM1939, Bk. 17 of PM Pg. 33
- PM1947, Bk. 17 of PM Pgs. 42-43 (PTN.)

ASSESSOR'S PARCEL MAP

1. THIS MAP WAS PREPARED FOR ASSESSMENT PURPOSES ONLY.
2. NO LIABILITY IS ASSUMED FOR ERRORS OR OMISSIONS.
3. ASSESSOR'S PARCELS ARE SHOWN IN ACCORDANCE WITH LOCAL LOT-SPLIT OR BUILDING SITE ORDINANCES.

RD
Jan 2, 2019
RUSSELL DUTRA

200' 400' 800'

NOTE - Assessor's Block Numbers Shown in Ellipses
Assessor's Parcel Numbers Shown in Circles.

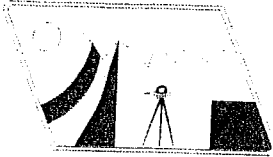

A.M. BAIRD

ENGINEERING & SURVEYING, INC.

1257 Main Street • P.O. Box 396 • Fortuna, CA. 95540 • (707) 725-5182 • Fax (707) 725-5581

CONSULTING - LAND DEVELOPMENT - DESIGN - SURVEYING

GRADING & EROSION CONTROL PLAN

AS-BUILT GRADING

PREPARED FOR

Moriah Appel
7050 CROOKED PRAIRIE RD
APN:221-221-009

WHITETHORN, HUMBOLDT COUNTY, CA



PREPARED BY:

ALLAN M. BAIRD, RCE 23681

June 1, 2020
Job#20-4888

GRADING NOTES:

1. NO KNOWN EASEMENTS.
2. NO TREES TO BE REMOVED.
3. APPROXIMATELY 500 CU. YDS. OF EXCAVATION OCCURRED INCREMENTALLY OVER SEVERAL YEARS.
4. GRADING OF THIS PROJECT IS NOT GREATER THAN 500 CU. YDS. AND SHALL BE DESIGNATED "MINOR GRADING"
5. ALL FILL MATERIAL SHALL NOT CONTAIN ANY IRREDUCIBLE MATERIAL (ROCK) GREATER THAN 12" DIAMETER OR CONTAIN AMOUNTS OF ORGANIC MATERIAL DETRIMENTAL TO THE STRUCTURAL INTEGRITY OF THE FILL.
6. THE EEL RIVER IS LOCATED SOUTH OF THE SOUTHERN PROPERTY BOUNDARY, APPROX. 700 FEET SOUTH OF THE FILL LOCATION.
7. NO KNOWN HAZARDOUS OR SENSITIVE AREAS, NO KNOWN HISTORICAL BUILDINGS OR ARCHAEOLOGICAL OR PALEONTOLOGICAL RESOURCES.

DIRECTIONS TO SITE:
 FROM EUREKA, TRAVEL 60 MILES SOUTH ON HWY. 101 TO REDWOOD DR. TRAVEL 2 MILES TO BRICELAND RD. ON RIGHT, TRAVEL 12.4 MILES TO ETTERSBURG RD. ON RIGHT, THEN AFTER 1 MILE TAKE SHARP LEFT TO BLUE SLIDE CREEK RD. AFTER 1.4 MILES, TURN RIGHT ON CROOKED PRAIRIE RD. DRIVEWAY IS 0.3 MILES ON LEFT.

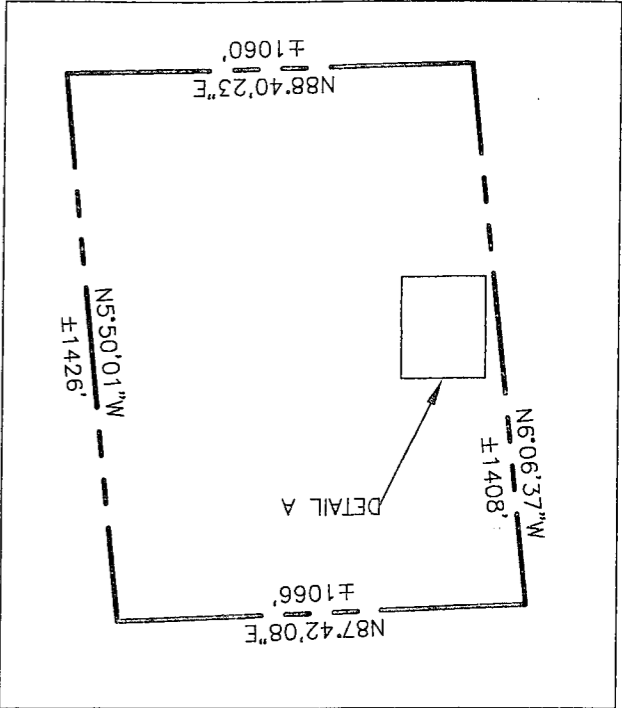

PARCEL OUTLINE
 1"=500'

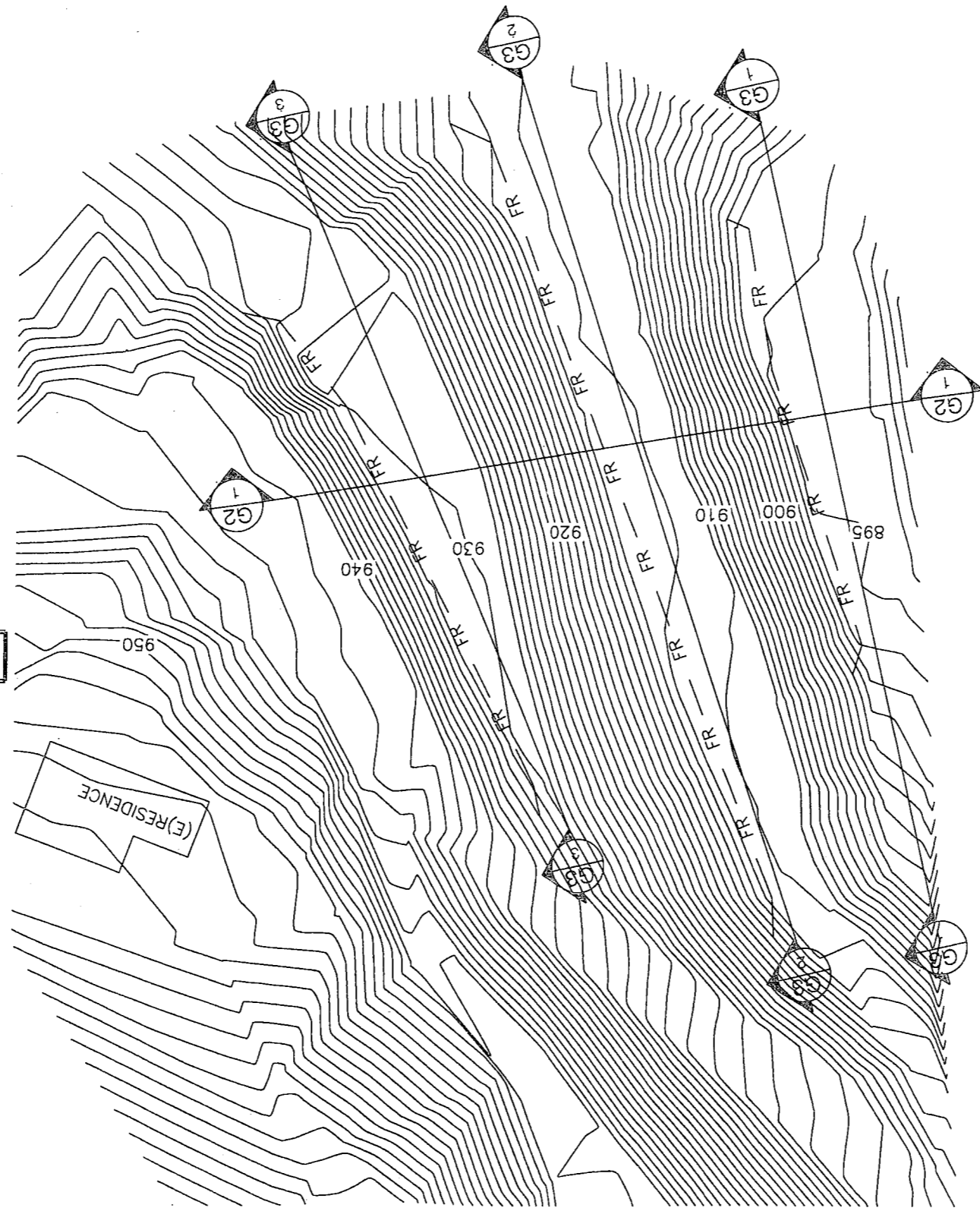

GRADING SITE PLAN (500 CY)
 DETAIL A

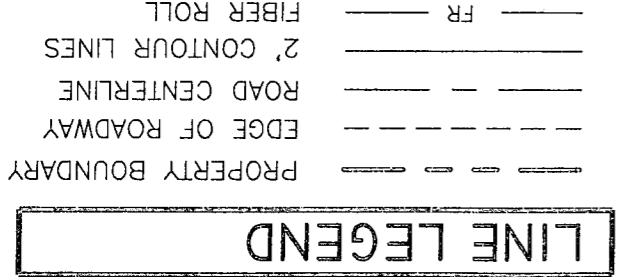
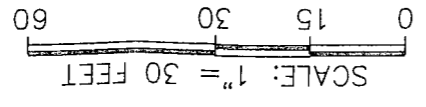

DISCLAIMER:
 MAPPING INFORMATION PROVIDED IS FOR SITE DESIGN PURPOSES ONLY. THIS SITE PLAN REFLECTS MANY MAPPING DETAILS THAT ARE USEFUL TO ASSURE THAT THE SITE FACILITIES ARE LOCATED APPROPRIATE TO THE SURROUNDINGS. HOWEVER, NONE OF THE INFORMATION SHOWN IS IMPLIED TO SUGGEST OR SUBSTITUTE FOR A CONTRACTED ACTUAL LAND SURVEY. A. M. BAIRD, ENGINEERING AND SURVEYING, INC. ASSUMES NO RESPONSIBILITY ARISING FROM THE USE OF INFORMATION PROVIDED, OTHER THAN WHAT HAS BEEN SPECIFICALLY INTENDED FOR THE SITE DESIGN.

PROJECT INFORMATION

AS-BUILT GRADING
 GRADING & EROSION PLAN

OWNER:
 MORIAH APPEL
 P.O. BOX 616
 WHITTHORN, CA 95589

SITE ADDRESS:
 7050 CROOKED PRAIRIE RD.
 WHITTHORN, CA

TOTAL AREA: 38.74 ACRES

PARCEL:
 PARCEL NUMBER: 221-221-009

A.M. Baird
 Engineering & Surveying
 1257 Main St., P.O. Box 306, Fortuna, CA 95540, (707)725-5182

SCALE AS SHOWN
DRAWN BY LAM
CHKD ALK
DATE 8/1/2009

MORIAH APPEL
 App# 221-221-009
 7050 CROOKED PRAIRIE RD, WHITTHORN, CA
 AS-BUILT GRADING
SITE PLAN

JOB NO. 20-4888
 SHEET NO. G1 OF 5

NO.	DATE	DESCRIPTION	BY

FIBER ROLLS DETAILS

SCALE: N.T.S.

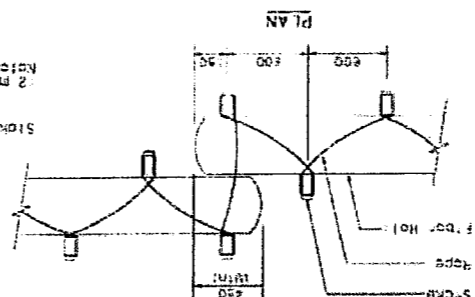
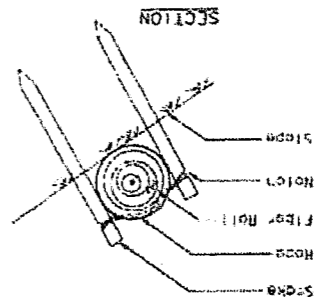
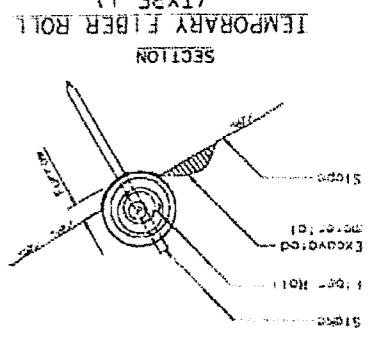
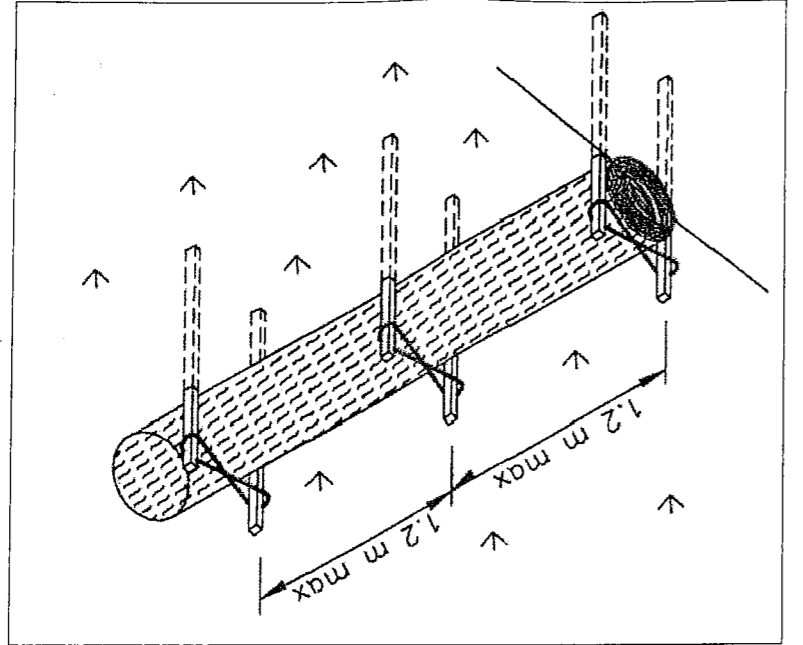
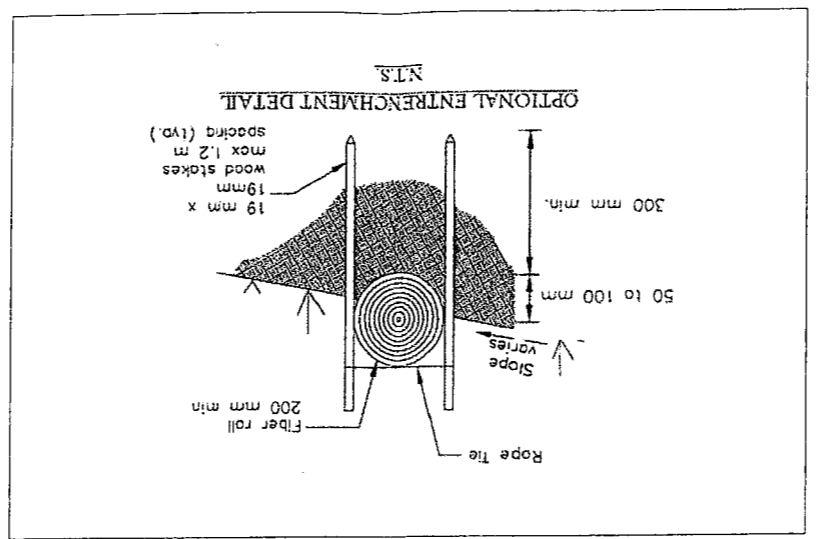
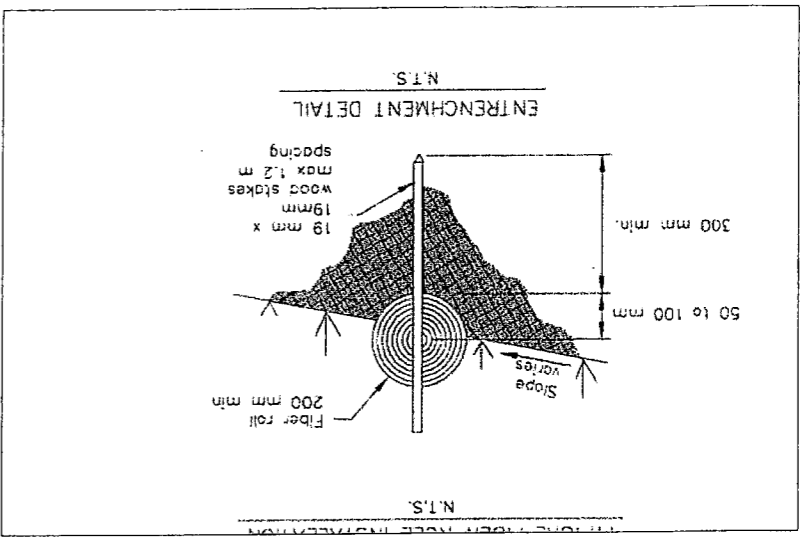

NOTE
1. Temporary fiber roll stakes shall be 200 mm x 12 mm depending upon design indication.

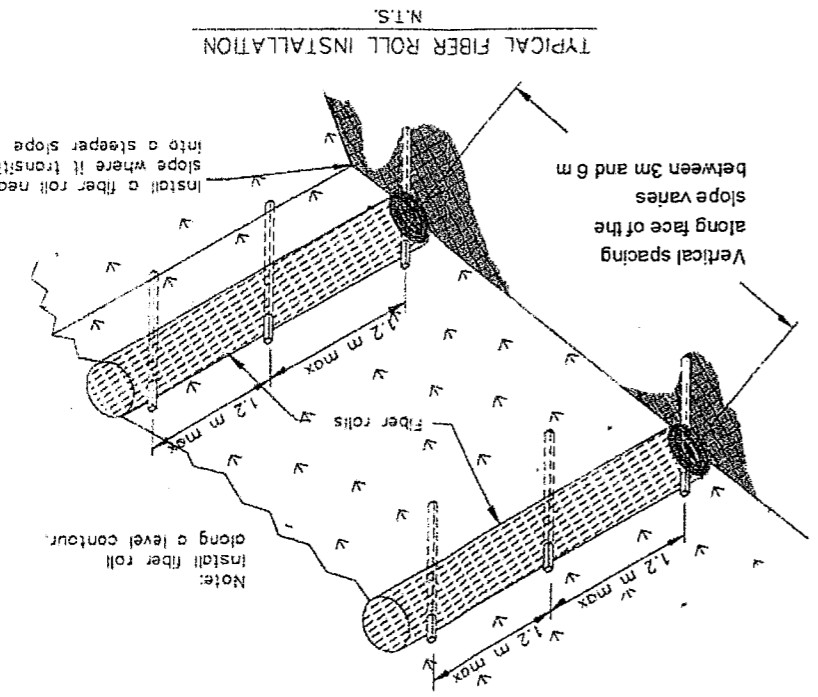
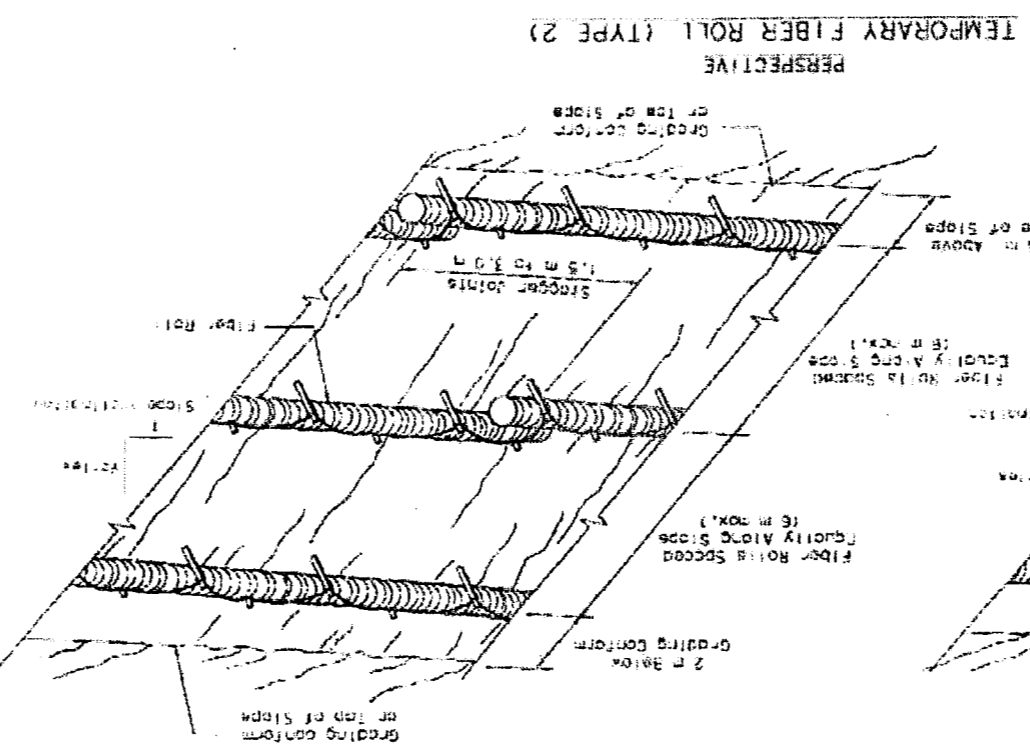
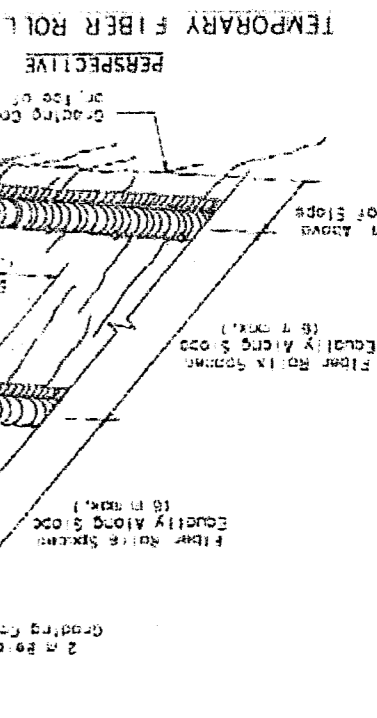

JOB # 20-4888 SHEET # 4 OF 5
MORIAN APPEL
AP#221-221-009
7050 CROOKED PRAIRIE RD. WHITEHORN, CA
AS-BUILT GRADING
GEC FIBER ROLLS
DATE: 6/1/2020
CHKD: A.M.B.
DRAWN BY: MAN
SCALE: N.T.S.

A.M. Baird
Engineering & Surveying, Inc.
1257 Main Street, P.O. Box 396,
Fortuna, CA 95540, (707) 725-5182

NO.	DATE	DESCRIPTION

REVISIONS

EROSION AND SEDIMENT CONTROL PLAN-IMPLEMENTATION MEASURES

GENERAL:

OWNER(S): MORIAH APPEL
 ORGANIZERS: A.M. BAIRD ENGINEERING & SURVEYING, INC.
 PROJECT LOCATION: 7050 CROOKED PRAIRIE RD. WHITEHORNS, CA
 ACTIVITY: CONSTRUCTION OF FILL PRISM ENGINEER'S DECLARATION:
 THIS EROSION & SEDIMENT CONTROL PLAN WAS PREPARED BY ME OR UNDER MY
 DIRECTION & IS BASED UPON THE CALTRANS CONSTRUCTION SITE EROSION MANAGEMENT
 PRACTICES (BMP)S MANUAL MARCH 2003.

ALLAN M. BAIRD R.C.E. 23,681

DATED 6/10/20

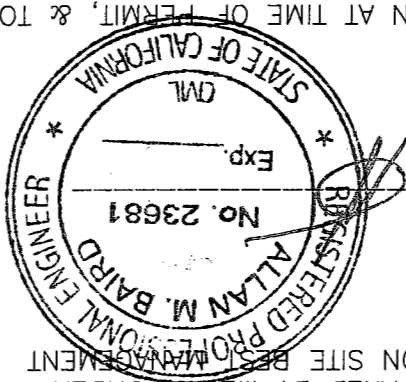

2. GRADING & EROSION CONTROL MEASURES TO BE TAKEN AT TIME OF PERMIT, & TO CONTINUE THROUGHOUT CONSTRUCTION PROCESS.
3. OWNER(S) INTEND TO BEGIN CONSTRUCTION AS SOON AS PERMIT IS ISSUED.
4. IF CONSTRUCTION IS TO OCCUR BETWEEN OCTOBER 15 & APRIL 15, SITE INSPECTIONS WILL BE CONDUCTED BY THE CONTRACTOR &/OR OWNER(S): PRIOR TO A FORECASTED STORM, AFTER A RAIN EVENT, WEEKLY THROUGHOUT THE RAINY SEASON, AND EVERY TWO WEEKS THROUGHOUT CONSTRUCTION
5. SITE WILL BE MONITORED DAILY DURING WET WEATHER BY CONTRACTOR &/OR OWNER(S). CONTRACTOR &/OR OWNER(S) ARE RESPONSIBLE FOR REPORTING ANY HAZARDOUS SITUATIONS TO THE ENGINEER.
6. IN THE EVENT THAT ANY ASPECT OF THIS PLAN FAILS, THE OWNER(S) IS/ARE RESPONSIBLE FOR IMMEDIATELY CONTACTING THE ENGINEER FOR RECOMMENDATION(S) AND A PROFESSIONAL CONTRACTOR SHALL FOLLOW RECOMMENDATION(S)
7. IF A FOOTING REVIEW IS REQUIRED, SITE MUST BE EVALUATED BY AN ENGINEER, & IF NECESSARY, ADDITIONAL EROSION CONTROL MEASURES WILL BE TAKEN.
8. UPON COMPLETION OF THE PERMITTED ROUGH GRADING WORK & AT THE FINAL COMPLETION OF THE WORK FOR "ENGINEERED GRADING", OR WHEN PROFESSIONAL INSPECTION IS PERFORMED FOR REGULAR GRADING; A FINAL REPORT SHALL BE SUBMITTED BY THE ENGINEER, IF REQUIRED.
9. THE PERMIT APPLICANT/OWNER(S) SHALL NOTIFY THE BUILDING OFFICIAL WHEN THE GRADING OPERATION IS READY FOR FINAL INSPECTION, AS REQUIRED.
10. IF REQUIRED BY NOTE NINE (9.) ABOVE, A FINAL REPORT SHALL BE PREPARED BY THE ENGINEER AND SUBMITTED TO THE HUMBOLDT COUNTY BUILDING DEPARTMENT BEFORE THE FINAL INSPECTION TO ENSURE THE SITE IS IN ACCORDANCE WITH THIS EROSION CONTROL PLAN & HUMBOLDT COUNTY CODE 331-17.

SEDIMENT CONTROL, SLOPE CONSTRUCTION, & PROTECTION OF WATER COURSES:

11. DIRECT RUNOFF FROM SPOUTS WILL DISCHARGE TO SPLASH BLOCKS & FLOW AWAY FROM THE FOUNDATION &/OR FILL. CONTRACTOR TO PROVIDE POSITIVE DRAINAGE AWAY FROM STRUCTURE AS PER CURRENT BUILDING CODE.
12. ALL EXPOSED, DISTURBED GROUND SHALL BE TEMPORARILY COVERED W/ TWO INCHES OF STRAW MULCH IMMEDIATELY FOLLOWING GRADING.
13. IF APPLICABLE, CUT &/OR FILL AREAS SHALL BE COVERED W/ NATIVE GRASSES, COVERED W/ STRAW MULCH, & KEPT MOIST UNTIL GRASSES ESTABLISH.
14. DRIVEWAY SHALL BE PAVED OR COVERED BY 4-INCHES BASE ROCK TO PREVENT VEHICLE TRACKING OF MUD ONTO PUBLIC ROADWAYS DURING CONSTRUCTION.
15. FIBER ROLLS SHALL BE CONSTRUCTED ON CONTOURS DOWN SLOPE OF DISTURBED AREAS, DETAILS ON SHEET THREE 3.
16. FIBER ROLL LOCATION(S), OTHER EROSION, & SEDIMENT CONTROL MEASURES WERE SPECIFICALLY PLACED BASED ON TOPOGRAPHY OF ENCLOSED MAP. MINOR CHANGES TO THE PROPOSED DEVELOPMENT THAT WOULD CHANGE THE ASSUMED DIRECTION OF SURFACE FLOWS SHOULD APPROPRIATELY CHANGE THE LOCATION OF FIBER ROLLS STATED IN NOTE 15.

DISPOSAL OF EXCAVATED MATERIALS:

17. APPROXIMATELY 500 CU. YDS. OF MATERIAL WILL BE IMPORTED ON SITE. NO SOIL TO BE REMOVED FROM SITE.
18. CUT & FILL SLOPES ARE NOT TO EXCEED 2:1 OR LESS AS PER PLANS; RUNOFF FROM ROOF/DRIVEWAY SHALL BE DIRECTED AWAY FORM CUT & FILL AREAS.
19. EROSION OF EXPOSED EXCAVATED MATERIALS WILL BE PREVENTED BY COMPACTING TO 85% BY TRACKING W/ HEAVY EQUIPMENT IN EIGHT INCH LIFTS. MULCHING, & RE-SEEDING IMMEDIATELY FOLLOWING PLACEMENT, IF APPLICABLE.
20. FILL PRISMS INTENDED FOR PARKING SHALL HAVE A RELATIVE COMPACTION OF 90% AND 95% RELATIVE COMPACTION FOR THE SUPPORT OF STRUCTURES.

REMOVAL OF VEGETATION & REVEGETATION:

21. EXISTING VEGETATION SHALL BE PROTECTED BY ESTABLISHING THE CONSTRUCTION BOUNDARY PRIOR TO COMMENCEMENT OF SOIL-DISTURBING ACTIVITIES.
22. EXISTING VEGETATION TO BE DISTURBED BY GRADING ACTIVITIES SHALL BE REPLACE W/ NATIVE GRASSES.
23. ALL EXPOSED CUT &/OR FILL SLOPES SHOULD BE RE-VEGETATED TO MATCH EXISTING VEGETATION IN SURROUNDING AREA.
24. CUT &/OR FILL SLOPES ARE LESS THAN NATURALLY OCCURRING SLOPES THAT SUPPORT PERMANENT VEGETATION.
25. SITE WILL BE MONITORED ON A DAILY BASIS DURING PERIODS OF HEAVY RAIN OR WIND. REAPPLICATION OF STRAW MULCH OR RE-SEEDING SHOULD BE COMPLETED AS NECESSARY.

SHEET # 65 OF 5 JOB # 20-4888	MORIAH APPEL AP#221-221-009 7050 CROOKED PRAIRIE RD. WHITEHORNS, CA AS-BUILT GRADING
GEC NOTES	
SCALE: N/A DRAWN BY: MWN DATE: 6/1/2020	A.M. Baird Engineering & Surveying, Inc. 1257 Main Street, P.O. Box 396, Fortuna, CA 95540, (707) 725-5182
NO. DATE REVISIONS	DESCRIPTION

Edwards Excavation & Restoration

P.O. Box 245
Whitethorn, Ca 95589
Phone (707)496-3353
edwardsexcavation@hotmail.com
General Engineering Contractor Lic.#971935

Estimate

Date	Estimate #
10/27/2021	4

Moriah Apple
831-818-9928

Description	Qty	Rate	Total
Job Location: 7050 Crooked Prairie -Notification		0.00	0.00
#1600-2020-0053-R1 Streambed Alteration Agreement			
Job Description: Crossing #1-Replacing undersized misalignment culvert with 24"x 50' culvert. Crossing #2-replcing culvert with rocked ford.		0.00	0.00
Mobilization & Demobilization	1	1,740.00	1,740.00
Equipment	1	3,000.00	3,000.00
Materials	1	11,400.00	11,400.00
Labor	1	1,200.00	1,200.00
Trucking	1	6,000.00	6,000.00
Total			\$23,340.00