

28759 Humboldt
PLN-11005-CUP

Site Management Plan

(Tier 1, Moderate Risk)

WDID - 1_12CC416512

Humboldt County
APN: 211-401-017-000, 211-401-018-000

Prepared by:



165 South Fortuna Boulevard, Fortuna, CA 95540
707-725-1897 • fax 707-725-0972
trc@timberlandresource.com

2/24/2020

Arrangement of Document Contents

- Purpose
- Tier Designation
- Scope of Report
- Methods
- Property Description
- General Location Map
- Project Description
- Additional Project Permitting
- **General Compliance Guide for Cannabis Cultivators**
 - Land Development and Maintenance, Erosion Control, and Drainage Features
 - Cleanup, Restoration, and Mitigation
 - Stream Crossing Installation and Maintenance
 - Soil Disposal and Spoils Management
 - Riparian and Wetland Protection and Management
 - Water Storage and Use
 - Fertilizers, Pesticides, and Petroleum Products
 - Cultivation Related Waste
 - Refuse and Domestic Waste
 - Annual Winterization Measures
- Statement of Limitations
- Site Maps
- Implementation Schedule
- Mitigation Report tables
- Applicable BPTC's (BMP's)
- Monitoring Plan
- Attachments
- **Applicable Technical Documents**
 - Site Management Plan (SMP)
 - Site Erosion and Sediment Control Plan (SESC)
- Pictures

Purpose

This Site Management Plan (SMP) has been prepared on behalf of the cannabis cultivator for the Humboldt County property identified as assessor parcel numbers 211-401-017-000, 211-401-018-000, by agreement and in response to the State Water Resources Control Board Cannabis Cultivation Policy (Cannabis Policy), in congruence with Order WQ 2019-0001-DWQ General Waste Discharge Requirements for Discharges of Waste Associated with Cannabis Cultivation Activities (General Order). The General Order implements the Cannabis Policy requirements, specifically those requirements that address waste discharges associated with cannabis cultivation activities. Cannabis cultivators covered under the General Order are subject to the requirements of the Cannabis Policy in its entirety. The Cannabis Policy provides a statewide tiered approach for permitting discharges and threatened discharges of waste from cannabis cultivation and associated activities, establishes a personal use exemption standard, and provides conditional exemption criteria for activities with a low threat to water quality.

Tier Designation

Tiers are defined by the amount of disturbed area. Tier 1 outdoor commercial cultivation activities disturb an area equal to or greater than 2,000 square feet and less than 1 acre (43,560 square feet). Tier 2 outdoor commercial cultivation activities disturb an area equal to or greater than 1 acre. Risk designation for Tier 1 and Tier 2 enrollees under the Cannabis Policy is based on the slope of disturbed areas and the proximity to a surface water body. Characterization is based on the risk designation summarized in Table 1 below.

Table 1: Summary of Risk Designation

Low Risk	Moderate Risk	High Risk
<ul style="list-style-type: none"> • No portion of the disturbed area is located on a slope greater than 30 percent, and • All of the disturbed area complies with the setback requirements. 	<ul style="list-style-type: none"> • Any portion of the disturbed area is located on a slope greater than 30 percent, and • All of the disturbed area complies with the setback requirements. 	<ul style="list-style-type: none"> • Any portion of the disturbed area is located within the setback requirements.

Thorough assessment of the project area including roads, disturbed areas, legacy features, and cultivation areas classify this enrollment into the **Tier 1, Moderate Risk** designation.

Scope of Report

Tier 1 and Tier 2 cannabis cultivators are required to submit and implement a Site Management Plan that describes how they are complying with the Requirements listed in Attachment A. The description shall describe how all applicable Best Practicable Treatment or Control (BPTC) measures are implemented. Cannabis cultivators within the North Coast Regional Water Quality Control Board jurisdiction are required to submit and implement Site Management Plans that describe how the Requirements are implemented property-wide, to include legacy activities. The SMP includes an Implementation Schedule to achieve compliance, but all work must be completed by the onset of the Winter Period each year. Projects designated as Moderate Risk are also required to have a Site Erosion and Sediment Control (plan) to achieve the goal of minimizing the discharge of sediment off-site. Projects designated as High Risk are also required to have a Disturbed Area Stabilization Plan to achieve the goal of stabilizing the disturbed area to minimize the discharge of sediment off-site and comply with the setback requirements. The cannabis cultivator shall ensure that all site operating personnel are familiar with the contents of the General Order and all technical reports prepared for the property. Projects which have over one acre of cannabis cultivation (total canopy area) are also required to have a Nitrogen Management Plan to describe how nitrogen is stored, used, and applied to crops in a way that is protective of water quality. A copy of the General Order, and technical reports required by the General Order, shall be kept at the cultivation site. Electronic copies of these documents are acceptable. Either format of maintained documents kept on site must be immediately presentable upon request.

Methods

The methods used to develop this SMP include both field and office components. The office component consisted of aerial photography review and interpretation, existing USGS quad map review, GIS mapping of field data, review of on-site photography points, streamflow calculations, general planning, and information gathered from the cannabis cultivator and/or landowner. The field component included mapping of all access roads, vehicle parking areas, Waters of the State, stream crossings, drainage features, cultivation sites, buildings, disturbed areas, and all other relevant site features within the project area and surrounding areas (as feasible). Cultivation areas, associated facilities, roads, and other developed and/or disturbed areas were assessed for discharges and related controllable water quality factors from the activities listed in the General Order. The field assessment also included an evaluation and determination of compliance with all applicable BPTC's per Section 2 of the General Order.


Property Description

The property assessed consists of two contiguous parcels totaling 22 acres located approximately 1-mile northwest of Miranda, California, at an elevation of approximately 400 feet above mean sea level. The property is located in Section 34, T2S, R3E, HB&M, Humboldt County, from the Miranda USGS 7.5' Quad. Unnamed Class II and III watercourse flows west-east through the property that drains to the South Fork Eel River.

Site Management Plan

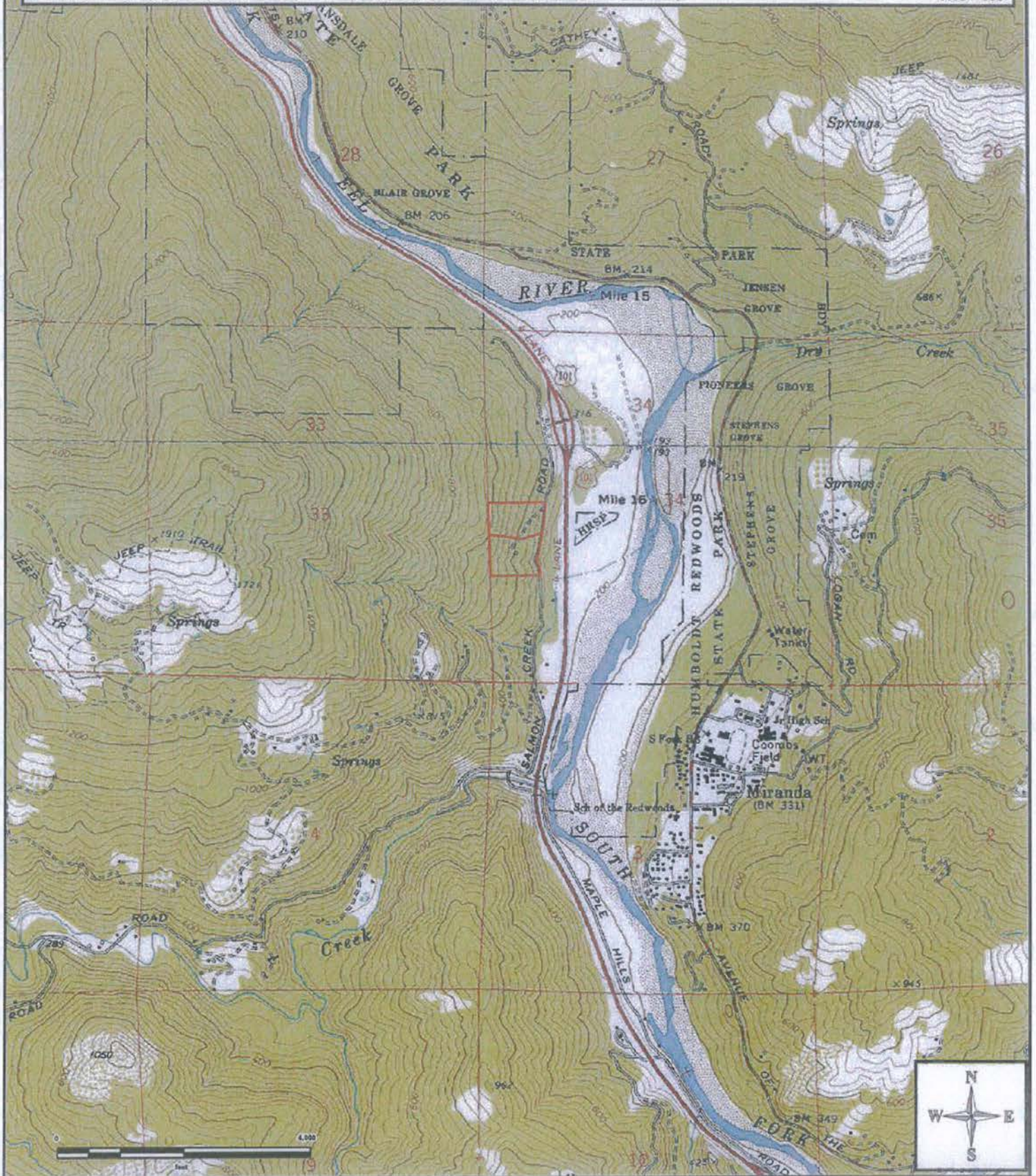
General Location Map [WDID - 1_12CC417900]



 Property Boundary

Located in Section 34, T2S, R3E, HB&M, Humboldt County, from the Miranda 7.5' USGS Quad Map

TRC - 135



Project Description

Cannabis cultivation on the property consists one 10' x 40' greenhouse, one 20' x 150' greenhouse, two 20' x 60' greenhouses, two 20' x 100' greenhouses, and approximately 13,600 ft² of outdoor cultivation, for a total, general cultivation area¹ of 23,400 ft². The cultivation areas are located within 29,725 ft² of disturbed area, which are located in four separate areas on the property. This project is being permitted by Humboldt County to cultivate cannabis. This project was previously enrolled in the North Coast Regional Water Quality Control Board Order No. R1-2015-0023 under WDID-1B161179CHUM and has since enrolled with State Water Resources Control Board as WDID-1_12CC416512. This project is being classified as Tier 1, Moderate Risk.

Table 1: Cultivation Site Parameters.

Cultivation Area	Land Disturbance Area (ft ²)	General Cultivation Area ¹ (ft ²)	Adjoining Hillslopes (% Grade)
A	13,600	13,600	25 – 35%
B	6,245	3,400	30 – 40%
C	4,245	2,400	30 – 40%
D	5,635	4,000	30 – 40%
Totals:	29,725	23,400	

¹ Area refers to the total land disturbance area. The total cannabis canopy area may vary considerably than the disturbance area.

Table 2: Project Permitting

Additional Required Permits Related to Project, Type, and Status	
SIUR	Not Required
LSAA/1600	Lake and Streambed Alteration Agreement from CDFW – Notification No. 1600-2019-0708-R1

Baseline Assessment of Requirements Related to Water Diversions and Waste Discharge for Cannabis Cultivation

This project was previously enrolled in the North Coast Regional Water Quality Control Board Order No. 2015-0023. A Water Resource Protection Plan (WRPP) was prepared by Timberland Resource Consultants. Some mitigations prescribed in the WRPP have since been completed. A re-assessment of the project was conducted and will be used as the baseline assessment for the preparation of this document.

Land Development and Maintenance, Erosion Control, and Drainage Features

Project Compliance Y /N

Roads are being classified as “permanent” (roads appurtenant to the project being used year-round), “seasonal” (roads appurtenant to the project being used primarily during summer months), “legacy” (roads not appurtenant to the project receiving little to no use), and “trail” (being used for occasional access to features on the property).

Roads within the project area appear to have a low native rock component and high imported rock component and, based on observations of surface erosion relative to current surface drainage break frequency, are being classified as having moderate erodibility. This classification will be utilized to determine surface/ditch-line drainage break frequency based on Table 19 of the Handbook for Forest Ranch and Rural Roads, 2014.

TABLE 19. Recommended maximum rolling dip and ditch relief culvert spacing, in feet, based on road gradient and soil erodibility ^{1,2}

Soil erodibility	Road gradient (%) and drainage structure spacing (feet)				
	0-3	4-6	7-9	10-12	>12
High to moderate	250	160	130	115	100
Low	400	300	250	200	160

Currently, all permanent roads on the property have adequate imported rock surfacing and do not require any more rock surfacing.

Roads assessed by TRC were found to be in acceptable condition with imported rock surfacing. The majority of access roads, permanent and seasonal, are out-sloped with gentle gradients and adequately drained to allow surface/ditch-line water drainage. However, sections of permanent roads and seasonal roads require either the maintenance of existing drainage features or installation of new drainage features. No wheel ruts were observed on the property.

Controllable Sediment Delivery Sites (CSDS) were found on the property. Runoff and sediment from Sites 01, 02, & 03 and road surfaces up slope at Sites 05, 06, 07, 08, 09, 10, 12 & 13) was found all hydrologically connected and discharging into surface waters. See the attached photographs, Mitigation Report, Treatment Implementation Schedule, and Site Map to follow for site specific details and treatments.

The Controllable Sediment Delivery Sites consist of a long, undrained, inside ditch along the access road (Sites 01, 02, & 03) to the property that drains into a watercourse further down slope and off of the property. Concentrated road surface and ditch flows from Sites 05, 06, 07, 08, 09, 10, 12 & 13 are contributing to the inside ditch along the access road. Installation of three ditch relief culverts (Sites 01, 03, & 07), the installation of staked wattles across the inside ditch and seeding and mulching a cutbank slump at Site 06, the maintenance of the inside ditch at Site 08, the rock surfacing of the road surface from Site 10 to 13, and the maintenance of the drainage feature at Site 12 will reduce erosion and hydrologically disconnect these CSD Sites.

Erosion of the road surface was observed at several locations. At Site 08, surface runoff is draining down the road and not being captured by an inside ditch here that has become obstructed with vegetation and debris. Erosion of the road surface is also occurring at Sites 10 to 12, and Sites 13 and 14 where existing rolling dips are being bypassed by road surface runoff and the lack of adequate rock surfacing is resulting in the erosion of the road surface further down grade.

No signs of erosion of the cultivation areas was observed.

No unstable areas, or signs of unstable areas, were observed on the property.

Cleanup, Restoration, and Mitigation:

Project Compliance Y/N

No revegetation besides seeding and mulching disturbed areas or sediment catchment sites are being prescribed.

Stream Crossing Installation and Maintenance:

Project Compliance Y/N

No watercourse crossings are located on the property.

Precipitation Depth-Duration-Frequency Values			Mean Annual Rainfall (in) =		
			50		
50-Year Storm			100-Year Storm		
Time, Min	Depth (in)	Inch/hr.	Time, Min.	Depth (in)	Inch/hr.
10	0.446	2.68	10	0.495	2.97

Soil Disposal and Spoils Management:

Project Compliance Y/N

Currently, no spoils are present on the property. Any/all spoils generated through development or maintenance of roads, driveways, earthen fill pads, or other cleared or filled areas have not been sidecast in any location where they can enter or be transported to surface waters. Any/all future spoils generated as a result of any future construction projects that are to be stored on the property shall be done so in accordance with the BTPC.

Riparian and Wetland Protection and Management:

Project Compliance Y/N

No disturbed areas were identified as being within riparian areas.

Table 4: Riparian and Wetland Protection and Management

Disturbed Area	Disturbance Area Distances and Riparian Setbacks ²				
	Class I [Setback: 100'] ²	Class II [Setback: 100']	Class III [Setback: 50']	Perennial Spring or Wetland [Setback: 50'] ²	Disturbed Area Within Setbacks [ft ²]
Cultivation Area A	>200'	~130'	>200'	>200'	0
Cultivation Area B	>200'	>200'	>200'	>200'	0
Cultivation Area C	>200'	>200'	>200'	>200'	0
Cultivation Area D	>200'	>200'	>200'	>200'	0
Total =					0

²This enrollment was previously enrolled in RWQCB Order No 2015-0023 and as such may retain reduced setbacks that were applicable under the previous Order.

Water Storage and Use:

Project Compliance Y/N

All water on the property is derived from a two groundwater well and a surface water diversion located on the property. The wells and surface water diversion (POD) meet and exceed the required water demands for both domestic and agricultural use. The POD is used for domestic use only. At present there are no metering devices or procedures (if non-jurisdictional e.g. wells or off-stream pond) in place to record water usage associated with the irrigation of cannabis. A metering device and procedure to monitor water usage shall be install and used yearly starting in 2020 to record all water diverted, pumped water, and used for the irrigation of cannabis and domestic use. Monthly water usage shall be recorded for annual reporting purposes.

Water is stored in three 2,500-gallon tanks and ten 3,000-gallon tanks. Multiple water storage tanks were found to have lids not in place to prevent access and entrapment of wildlife. Tank lids shall be kept closed at all times when access is not needed. Tanks that do not utilize lids shall be retrofitted to be enclosed from wildlife. Overflow prevention measures shall be installed on water storage and transfer infrastructure or water storage tanks to prevent the overflowing of tanks and unnecessary waste of water resources when water storage infrastructure has filled. Water conservation measures such as drip line irrigation, morning or evening watering, and mulch or cover cropping of cultivated top soils shall also be implemented.

At this time, the cannabis cultivator has 32,500 gallons of water storage installed. Based on estimates, this volume of storage combined with the output from the wells is sufficient to allow for full forbearance from any surface water diversion to irrigation during the required period from April 1st to October 31st. Monthly water usage estimates and the season total are as follows below.

Table 5: Estimated Annual Water Use

	Jan	Feb	March	April (15%)	May (40%)	Jun (80%)	Jul (100%)	Aug (100%)	Sep (70%)	Oct (20%)	Nov	Dec
Agriculture				5,441	14,040	28,080	35,100	35,100	24,570	7,020		
Sq. ft. =								% = percent of peak usage				
23,400												
									Total AG Water Use =		149,351	

Cannabis cultivators should be advised that transition to the state General Order will require additional infrastructure to use bladders for water storage. Per Cannabis Cultivation Policy: Attachment A, Section 2, No. 88 & 89 for cannabis cultivators, bladders shall be safely contained within a secondary containment system with sufficient capacity to capture 110 percent of a bladders maximum volume in the event of bladder failure and if open to rainfall, and/or (whichever is larger) capable to accommodate precipitation and storm water inputs from 24 hours of a 25-year storm event. Secondary containment is recommended in the form of a dirt berm, containment pit, combination of both, or impermeable material with skeletal support.

There is domestic water use at this time on this property. Water meter(s) and water supply infrastructure shall be designed/installed in a manner such that water usage for the irrigation of cannabis can be recorded separately from water used for domestic use. Additionally, if there are multiple diversions of surface water, infrastructure/metering device(s) shall be design/installed in a manner that each source of surface water is recorded separately.

A Lake and Streambed Alteration Agreement with the California Department of Fish and Wildlife, as well as an Initial Statement of Water Diversion and Use with the California State Water Resource Control Board Division of Water Rights, has been finalized as of the writing of this assessment. Any additional guidelines, treatments, or restrictions set forth under the finalized Lake and Stream Agreement shall be followed.

Irrigation Runoff:

During visits to the property, no irrigation runoff, or evidence of such runoff, was observed at any of the cultivation areas.

Fertilizers, Soils, Pesticides, and Petroleum Products:Project Compliance Y /N

Fertilizers, pesticides, potting soils, compost, and other soils and soil amendments are currently on the property in a manner in which they will not enter or be transported into surface waters and so that nutrients or other pollutants will not be leached into groundwater. Cultivation areas are currently maintained so as to prevent nutrients from leaving the site during the growing season and post-harvest.

Fertilizers and soil amendments shall be applied and used per the manufacturer's guidelines. The use of pesticide products shall be consistent with product labeling and all products on the property are to be stored in closed structures to ensure that they do not enter or are released into surface or ground waters.

Currently, no bulk fuel storage and associated petroleum products are present on the property. Small quantities of fuel are also stored within fuel canisters and motor oil is stored the original motor oil container, alongside small generators that power fertilizer mixing tanks or pump water around the property. Neither the fuel and motor oil or the small generators have secondary containment. If trailered generators are used, they shall have adequate secondary containment and if they are used during the winter period, also have adequate cover from precipitation.

Any/all fuel canisters, motor oil containers, and generators (large or small) shall be stored in secondary containment (e.g. drip pans, plastic totes, or sealed metal boxes) while being stored long term or not in immediate use, wherever these materials are used anywhere on the property, outside of riparian setbacks at all times. See the Mitigation Report, Treatment Implementation Schedule, and Site Map to follow for site specific details and treatments.

Should the cannabis cultivator at any point in the future obtain fuel storage or petroleum products, any/all future petroleum products and other liquid chemicals, including but not limited to diesel, biodiesel, gasoline, and oils shall be stored so as to prevent their spillage, discharge, or seepage into receiving waters. Storage tanks and containers shall be of suitable material and construction to be compatible with the substance(s) stored and conditions of storage such as pressure and temperature. Above ground storage tanks and containers shall be provided with a secondary means of containment for the entire capacity of the largest single container and sufficient cover shall be provided to prevent any/all precipitation from entering said secondary containment vessel. Cannabis cultivators shall ensure that diked areas are sufficiently impervious to contain discharged chemicals. Cannabis cultivators shall implement spill prevention, control, and countermeasures (SPCC) and have appropriate cleanup materials available onsite if the volume of a fuel container is greater than 1,320 gallons. Underground storage tanks 110 gallons and larger shall be registered with the appropriate County department and comply with state and local requirements for leak detection, spill overflow, corrosion protection, and insurance coverage. On site storage of petroleum products, or other fuels used for commercial activities may require registration as hazardous materials through the California Environmental Reporting System (CERS). Additionally, any waste oil generated from commercial activities (generators) is considered by the state hazardous waste

and requires addition reporting. This cannabis cultivator is advised to contact local agencies to find out if such reporting is applicable to currently operations.

Cultivation-Related Wastes:

Project Compliance Y /N

No cultivation-related wastes, including, but not limited to, empty soil/soil amendment/fertilizer/pesticide bags and containers, empty plant pots or containers, dead or harvested plant waste, and spent growth medium, are stored in locations where they can enter or be blown into surface waters, or in a manner that could result in residues and pollutants within such materials to migrate or leach into surface water or groundwaters.

Organic cultivation-related wastes are collected from the cultivation areas and either disposed of properly with general waste or composted. The cannabis cultivator shall ensure that the locations where organic wastes are stored or composted are minimized in number and are sited outside of watercourse riparian areas and away from any form of surface runoff.

Non-organic cultivation-related wastes are securely stored in trash bags, trash bins, and a utility trailer at the cultivation areas, residences, and within a contained refuse storage shed adjacent to the residences prior to disposal at an appropriate waste disposal facility. The cannabis cultivator shall continue to gather and properly dispose of cultivation-related wastes and ensure that wastes are adequately contained from scavenging wildlife, and cannot be transported away from storage areas by wind or surface runoff.

Refuse and Domestic Waste:

Project Compliance Y /N

Garbage and refuse are securely stored in trash bags, trash bins, and a utility trailer at the cultivation areas, residences, and within a contained refuse storage shed adjacent to the residences prior to disposal at an appropriate waste disposal facility. The cannabis cultivator shall continue to gather and properly dispose of refuse and ensure that refuse is adequately contained from scavenging wildlife, and cannot be transported away from storage areas by wind or surface runoff.

Human waste is managed by a permitted septic system on site. It is the cannabis cultivator's responsibility to ensure compliance of such action with the Humboldt County Department of Environmental Health and Human Services.

Annual Winterization Measures

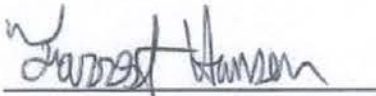
Winterization measures consist of general cleanup and winter-preparation activities that both prepare for, and utilize, anticipated, local winter weather.

- Any exposed soils resulting from winterization activities shall be seeded and straw mulched.
- Any/all areas of exposed soils in and around cultivation areas be seeded and either straw mulched with weed free straw or woodchips.
- All existing culvert inlets, interiors, and outlets shall be cleared of any existing or potential obstructions to include; debris upstream of the culvert such as sediment, loose, moveable rocks, and raftable, small, woody debris.
- Damage or wear resulting from vehicular use to road surfaces (such as rutting or wheel tracks) and/or road surfacing (such as rock) that would impair road surface drainage or drainage features (such as outsloping, waterbars, rolling dips, etc.) shall be repaired prior to the Winter Period.
- All existing surface drainage features and sediment capture features shall be maintained if needed to ensure continued function through the Winter Period.
- All fertilizers and petroleum products will be stored in an area located outside of riparian setbacks, completely sealed, placed in a secondary containment (liquids), and stored in a manner that prevents contact with precipitation and surface runoff.
- Chemical toilets will be removed from the property until need resumes the following cultivation season, or at a minimum serviced and left unused during periods when not in use.
- Water storage tank lids shall be appropriately closed to prevent the access of wildlife.
- All refuse/trash shall be removed and disposed of appropriately.
- All inorganic material capable of being transported by wind or rain shall be secured and stored appropriately.

**STATEMENT OF CONTINGENT AND LIMITING CONDITIONS CONCERNING
THE PREPARATION AND USE OF REPORTS ADDRESSING GENERAL
WASTE DISCHARGE REQUIREMENTS UNDER ORDER WQ 2017-0023-DWQ**

Prepared by Timberland Resource Consultants

1. This document has been prepared for the property within APN 211-401-017-000, 211-401-018-000, in Humboldt County, for enrollment in the General Waste Discharge Order WQ 2019-0001-DWQ.
2. Timberland Resource Consultants does not assume any liability for the use or misuse of the information in this document.
3. The information is based upon conditions apparent to Timberland Resource Consultants at the time inspection(s) were conducted. Changes due to land use activities or environmental factors occurring after inspection, have not been considered in this document.
4. Maps, photos, and any other graphical information presented in this report are for illustrative purposes. Their scales are approximate, and they are not to be used for locating and establishing boundary lines.
5. The conditions presented in this document may differ from those made by others or from changes on the property occurring after inspections were conducted. Timberland Resource Consultants does not guarantee this work against such differences.
6. Timberland Resource Consultants did not conduct an investigation on a legal survey of the property.
7. Persons using this document are advised to contact Timberland Resource Consultants prior to such use.
8. Timberland Resource Consultants will not discuss this document or reproduce it for anyone other than the Client for which this document was prepared without authorization from the Client.



Forrest Hansen

Timberland Resource Consultants

Site Management Plan

Site Map [WDID - 1_12CC416512]



40' contour intervals
Map Date 2/15/2020

TRC - 135

- Property Boundary HUM
- Past Cultivation
- Cultivation Area
- Structure
- Riparian Area
- Disturbed Area

- Watercourses**
- Class II
- Class III
- Roads**
- County
- Permanent
- Seasonal Access
- Foot Trail
- Legacy



- Site
- POD
- Tank
- Bladder
- Well



Site Management Plan

Site Map [WDID - 1_12CC416512]

- | | |
|---|--|
|  Property Boundary HUM |  Past Cultivation |
|  Riparian Area |  Cultivation Area |
|  Disturbed Area |  Structure |

- Watercourses**
-  Class II
 -  Class III

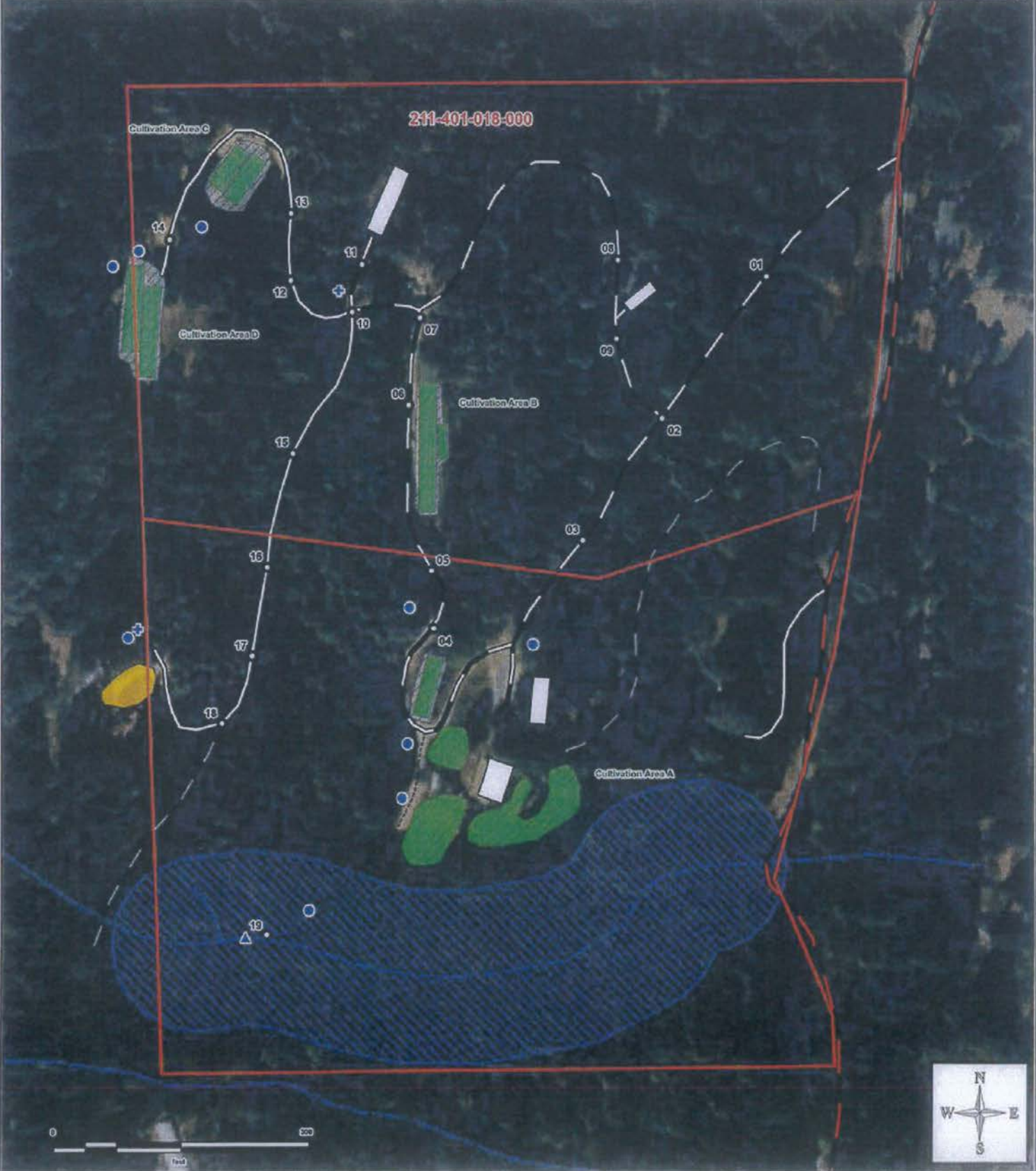
- Roads**
-  County
 -  Permanent
 -  Seasonal Access
 -  Foot Trail
 -  Legacy


- Site**
-  POD
 -  Tank
 -  Bladder
 -  Well



2018 NAIP DOQ
Map Date 2/15/2020

TRC - 135



 Treatment Implementation Schedule	
Unique Point	Proposed Work Completion Date
Immediately	
Site 19	Immediately
Past Cultivation Areas	Immediately
Water Storage and Use	Immediately
Liquid Petroleum Products	Immediately
Generators and Gas Powered Pumps	Immediately
Prior to 10/15/2020	
Site 1	Prior to 10/15/20
Site 2	Prior to 10/15/20
Site 3	Prior to 10/15/20
Site 6	Prior to 10/15/20
Site 7	Prior to 10/15/20
Site 8	Prior to 10/15/20
Site 10	Prior to 10/15/20
Site 11	Prior to 10/15/20
Site 12	Prior to 10/15/20
Site 13	Prior to 10/15/20
Site 14	Prior to 10/15/20
Site 15	Prior to 10/15/20
Site 16	Prior to 10/15/20
Site 17	Prior to 10/15/20
Site 18	Prior to 10/15/20
Prior to 10/15/2021	
Site 5	Prior to 10/15/21
Site 9	Prior to 10/15/21
As required	
Site 4	As required



SMP - Mitigation Report

WDID# - 1_12CC416512

Unique Point	Lat-Long NAD 83	Road Type	Mitigation Planned	Monitor	1600	Treatment Priority	Date Completed
Site 1	-123.833348 40.246824	Permanent	X	X	-	Prior to 10/15/20	
Current Condition: Long undrained inside ditch that is concentrating surface runoff from multiple locations across the property.						Prescribed Action: Install a 18" diameter ditch relief culvert per the specifications outlined in the attached BMPs: See Ditch Relief Culvert, and Permanent Culvert Crossing Design (Inlet and Outlet Armoring), General Operations BMPs, and General Erosion Control specifications.	
Unique Point	Lat-Long NAD 83	Road Type	Mitigation Planned	Monitor	1600	Treatment Priority	Date Completed
Site 2	-123.833783 40.246368	Permanent	X	X	-	Prior to 10/15/20	
Current Condition: Inside ditch crossing consisting of an 18" diameter smooth-walled pipe that has become obstructed at the inlet and outlet with debris.						Prescribed Action: Clear the inlet and outlet of the ditch crossing culvert. Clear the inside ditch above and below of debris.	
Unique Point	Lat-Long NAD 83	Road Type	Mitigation Planned	Monitor	1600	Treatment Priority	Date Completed
Site 3	-123.834112 40.245973	Permanent	X	X	-	Prior to 10/15/20	
Current Condition: Long undrained inside ditch that is concentrating surface runoff from multiple locations across the property. The inside ditch up grade of this site requires clearing.						Prescribed Action: Clear the inside ditch up grade to Cultivation Area A. Install a 18" diameter ditch relief culvert per the specifications outlined in the attached BMPs: See Ditch Relief Culvert, and Permanent Culvert Crossing Design (Inlet and Outlet Armoring), General Operations BMPs, and General Erosion Control specifications.	
Unique Point	Lat-Long NAD 83	Road Type	Mitigation Planned	Monitor	1600	Treatment Priority	Date Completed
Site 4	-123.834736 40.245688	Permanent	-	X	-	As required	
Current Condition: Low point in the road grade is draining road surface runoff.						Prescribed Action: Monitor. If road surface runoff begins to bypass this site install a rocked rolling dip per the specifications outlined in the attached BMPs. See attached BMPs: Rocked/Rolling Dip Design and Placement, General Operations BMPs, and General Erosion Control specifications.	
Unique Point	Lat-Long NAD 83	Road Type	Mitigation Planned	Monitor	1600	Treatment Priority	Date Completed
Site 5	-123.834748 40.245871	Permanent	X	X	-	Prior to 10/15/21	
Current Condition: Ditch relief culvert consisting of a 18" diameter smooth-walled plastic pipe. This ditch relief culvert is functioning adequately, however it lacks a sufficient rock armor energy dissipater at the outlet.						Prescribed Action: Hand place and key in rock armoring around the outfall of the culvert per the specifications outlined in the attached BMPs: See Permanent Culvert Crossing Design: Inlet and Outlet Armoring.	



SMP - Mitigation Report

WDID# - 1_12CC416512

Unique Point	Lat-Long NAD 83	Road Type	Mitigation Planned	Monitor	1600	Treatment Priority	Date Completed
Site 6	-123.834852 40.2464	Permanent	X	X	-	Prior to 10/15/20	
<p>Current Condition: Road surface runoff from up grade at Site 10 to Site 13 is not adequately being captured and drained off of the road surface at Site 12 and 13 and draining onto the cutbank here, resulting in instability of the cutbank. The maintaining of the drainage features up slope will stop road surface runoff draining onto this cutbank.</p>						<p>Prescribed Action: Interim measure: Install four staked wattles across the inside ditch at 15' intervals. Seed and mulch the slumped cutbank material with native grass seed and weed free straw(or woodchips). Permanent measures: See Sites 10 - 13.</p>	
Unique Point	Lat-Long NAD 83	Road Type	Mitigation Planned	Monitor	1600	Treatment Priority	Date Completed
Site 7	-123.834808 40.246679	Permanent	X	X	-	Prior to 10/15/20	
<p>Current Condition: Concentrated ditch flows are contributing to sediment discharge at sites further down grade and slope as well as eroding the toe of an cutbank slump that has entered in the inside ditch at Site 06.</p>						<p>Prescribed Action: Install a 18" diameter ditch relief culvert per the specifications outlined in the attached BMPs: See Ditch Relief Culvert, and Permanent Culvert Crossing Design (Inlet and Outlet Armoring), General Operations BMPs, and General Erosion Control specifications.</p>	
Unique Point	Lat-Long NAD 83	Road Type	Mitigation Planned	Monitor	1600	Treatment Priority	Date Completed
Site 8	-123.833976 40.24687	Permanent	X	X	-	Prior to 10/15/20	
<p>Current Condition: Concentrated road surface runoff is being constrained to the road surface via the tread path and is not being captured by the inside ditch here. The inside ditch has become obstructed with debris and vegetation.</p>						<p>Prescribed Action: Clear the inside ditch from here to the inlet of the ditch relief culvert at Site 09.</p>	
Unique Point	Lat-Long NAD 83	Road Type	Mitigation Planned	Monitor	1600	Treatment Priority	Date Completed
Site 9	-123.833978 40.24662	Permanent	X	X	-	Prior to 10/15/21	
<p>Current Condition: Ditch relief culvert consisting of a 18" diameter smooth-walled plastic pipe. This ditch relief culvert is functioning adequately, however it lacks a sufficient rock armor energy dissipater at the outlet.</p>						<p>Prescribed Action: Hand place and key in rock armoring around the outfall of the culvert per the specifications outlined in the attached BMPs: See Permanent Culvert Crossing Design: Inlet and Outlet Armoring.</p>	
Unique Point	Lat-Long NAD 83	Road Type	Mitigation Planned	Monitor	1600	Treatment Priority	Date Completed
Site 10	-123.835095 40.246696	Seasonal	X	X	-	Prior to 10/15/20	
<p>Current Condition: The steep road surface from this site to Site 13 lacks adequate rock surfacing and is eroding.</p>						<p>Prescribed Action: Apply rock surfacing to the road surface from this site up grade to Site 13.</p>	
Unique Point	Lat-Long NAD 83	Road Type	Mitigation Planned	Monitor	1600	Treatment Priority	Date Completed
Site 11	-123.835056 40.246847	Permanent	X	X	-	Prior to 10/15/20	
<p>Current Condition: An inside ditch drains to this location and is relieved via a waterbar across the road surface. The inside ditch has become obstructed via a soft road shoulder and the waterbar is downcutting and lacks rock surfacing, resulting in the erosion of the crossing point as well as the outlet of the waterbar.</p>						<p>Prescribed Action: Re-establish the inside ditch to the outlet of the ditch relief culvert at Site 12. Apply 2" - 4" crushed angular rock surfacing to the road surface across the waterbar crossing point and install a rock apron at the outlet of the waterbar consisting of 4" - 6" crushed angular rock.</p>	



SMP - Mitigation Report

WDID# - 1_12CC416512

Unique Point	Lat-Long NAD 83	Road Type	Mitigation Planned	Monitor	1600	Treatment Priority	Date Completed
Site 12	-123.835354 40.246794	Seasonal	X	X	-	Prior to 10/15/20	
<p>Current Condition: Ditch relief culvert consisting of a 18" diameter smooth-walled plastic pipe. The culvert is short in the fill by design so that flows do not immediately outlet onto the cutbank below. The outlet has become obstructed with debris, lacks a rock armor energy dissipator, as well as a poorly constructed outlet trench with perched fill along the sides of the trench. There is also perched fill around the inlet of the culvert and the associated inside ditch draining to the inlet. The inside ditch draining to the inlet also requires clearing.</p>						<p>Prescribed Action: Clear the obstructing debris at the outlet. Remove the perched fill along the outlet and inlet of the ditch relief culvert, as well as the inside ditch draining to the inlet. Lay back the slopes along the outlet trench to a 2:1(50%) slope ratio. Clear and enlarge the inside ditch from the inlet to approximately 100' up grade. Hand place and key in rock armoring around the outfall of the culvert per the specifications outlined in the attached BMPs: See Permanent Culvert Crossing Design: Inlet and Outlet Armoring.</p>	
Unique Point	Lat-Long NAD 83	Road Type	Mitigation Planned	Monitor	1600	Treatment Priority	Date Completed
Site 13	-123.835356 40.247005	Seasonal	X	X	-	Prior to 10/15/20	
<p>Current Condition: An existing rolling dip is being bypassed by road surface runoff.</p>						<p>Prescribed Action: Maintenance the rolling dip so that it adequately drains road surface runoff and upgrade the rolling dip to a rocked rolling to the specifications outlined in the attached BMPs. See attached BMPs: Rocked/Rolling Dip Design and Placement, General Operations BMPs, and General Erosion Control specifications.</p>	
Unique Point	Lat-Long NAD 83	Road Type	Mitigation Planned	Monitor	1600	Treatment Priority	Date Completed
Site 14	-123.835863 40.246918	Seasonal	X	X	-	Prior to 10/15/20	
<p>Current Condition: Existing rolling dip/outsloping. Erosion of the road surface is occurring and the road surface runoff is concentrating, resulting in the erosion of the outboard edge of the road.</p>						<p>Prescribed Action: Upgrade the existing rolling to a rocked rolling dip by rock surfacing the road surface with competent rock across the existing rolling dip up to the greenhouses.</p>	
Unique Point	Lat-Long NAD 83	Road Type	Mitigation Planned	Monitor	1600	Treatment Priority	Date Completed
Site 15	-123.835337 40.246243	Seasonal	X	X	-	Prior to 10/15/20	
<p>Current Condition: Kickout drainage feature is being bypassed by road surface runoff, resulting in the erosion of the road surface.</p>						<p>Prescribed Action: Install a waterbar per the specifications outlined in the attached BMPs: See Waterbar Construction, General Operations BMPs, and General Erosion Control specifications. Maintain as needed.</p>	
Unique Point	Lat-Long NAD 83	Road Type	Mitigation Planned	Monitor	1600	Treatment Priority	Date Completed
Site 16	-123.83544 40.245877	Seasonal	X	X	-	Prior to 10/15/20	
<p>Current Condition: Concentrated road surface runoff is being constrained to the road surface, resulting in the erosion of the road surface.</p>						<p>Prescribed Action: Install a waterbar per the specifications outlined in the attached BMPs: See Waterbar Construction, General Operations BMPs, and General Erosion Control specifications. Maintain as needed.</p>	



SMP - Mitigation Report

WDID# - 1_12CC416512

Unique Point	Lat-Long NAD 83	Road Type	Mitigation Planned	Monitor	1600	Treatment Priority	Date Completed
Site 17	-123.835499 40.245594	Seasonal	X	X	-	Prior to 10/15/20	
Current Condition: Concentrated road surface runoff is being constrained to the road surface, resulting in the erosion of the road surface.						Prescribed Action: Install a waterbar per the specifications outlined in the attached BMPs: See Waterbar Construction, General Operations BMPs, and General Erosion Control specifications. Maintain as needed.	
Unique Point	Lat-Long NAD 83	Road Type	Mitigation Planned	Monitor	1600	Treatment Priority	Date Completed
Site 18	-123.835623 40.24538	Seasonal	X	X	-	Prior to 10/15/20	
Current Condition: Concentrated road surface runoff is being constrained to the road surface, resulting in the erosion of the road surface.						Prescribed Action: Install a waterbar per the specifications outlined in the attached BMPs: See Waterbar Construction, General Operations BMPs, and General Erosion Control specifications. Maintain as needed.	
Unique Point	Lat-Long NAD 83	Road Type	Mitigation Planned	Monitor	1600	Treatment Priority	Date Completed
Site 19	-123.835424 40.244709	-	X	X	-	Immediately	
Current Condition: A portable water pump and associated fuel canister is located within the riparian setbacks of the nearby watercourse.						Prescribed Action: Remove the fuel pump and fuel canister outside of the 100' riparian setbacks. Install secondary containment on the pump and place the fuel canister in secondary containment equal or greater than the volume of the fuel canister.	
Unique Point	Lat-Long NAD 83	Road Type	Mitigation Planned	Monitor	1600	Treatment Priority	Date Completed
Past Cultivation Areas	N/A	-	X	X	-	Immediately	
Current Condition: Past cultivation areas that are no longer used with remaining cultivation-related materials, fencing, wastes, and soils.						Prescribed Action: Remove any remaining fencing, pots, or other cultivation-related wastes and materials from these areas. Seed and mulch the Past Cultivation Area, and any Disturbed Area associated with its removal, with native grass seed and weed free straw(or woodchips). If cultivation soil is not re-used, contour the cultivation-related soils into the ground outside of any riparian buffer areas, and seed and mulch the contoured soils with native grass seed and weed free straw.	



SMP - Mitigation Report

WDID# - 1_12CC416512

Unique Point	Lat-Long NAD 83	Road Type	Mitigation Planned	Monitor	1600	Treatment Priority	Date Completed
Water Storage and Use	N/A	-	X	X	-	Immediately	
<p>Current Condition: At present there are no devices or procedures in place to record water usage associated with the irrigation of cannabis and domestic use.</p>						<p>Prescribed Action: Water metering devices, or procedures for the wells, shall be installed to record all water diverted, pumped, and used water for the irrigation of cannabis and domestic use. Water meter(s) and water supply infrastructure shall be designed/installed in a manner such that water usage for the irrigation of cannabis can be recorded separately from water used for domestic use. Additionally, if there are multiple sources of water, infrastructure/metering device(s) shall be design/installed in a manner that each source of water is recorded separately. Monthly water usage shall be recorded for annual reporting purposes. Also, water storage tank lids shall be appropriately closed to prevent the access of wildlife and, if not currently implemented, water conservation measures such as drip line irrigation, morning or evening watering, and mulch or cover cropping of cultivated top soils shall also be implemented.</p>	
Unique Point	Lat-Long NAD 83	Road Type	Mitigation Planned	Monitor	1600	Treatment Priority	Date Completed
Liquid Petroleum Products	N/A	-	X	X	-	Immediately	
<p>Current Condition: All liquid petroleum products (e.g. any size container of any petroleum product) requires secondary containment while not in immediate use and cover from precipitation during the wet season. Adequate quantities of absorbent materials shall also be stored at all locations where these types of materials are used and stored.</p>						<p>Prescribed Action: Any/all liquid petroleum products and their containers shall be stored in secondary containment (e.g. plastic totes or sealed metal boxes) while being stored long term or not in immediate use, wherever these materials are used anywhere on the property. Adequate quantities of absorbent materials (e.g. purpose made materials for oil and fuel spills, cat litter) shall be stored at all locations where these types of materials are used and stored. Should a spill of these materials occur, absorbent materials will be applied immediately and allowed enough time to absorb as much material as possible. Following treatment, absorbent materials applied as well as any contaminated soil will be removed and disposed of appropriately for the spilled material. See attached BMPs: Generator, Fuel, and Oil Management for further details.</p>	
Unique Point	Lat-Long NAD 83	Road Type	Mitigation Planned	Monitor	1600	Treatment Priority	Date Completed
Generators and Gas Powered	N/A	-	X	X	-	Immediately	
<p>Current Condition: All liquid petroleum powered generators and pumps require secondary containment, and cover from precipitation during the wet season. Adequate quantities of absorbent materials shall also be stored at all locations where the generators and gas powered pumps are used and stored.</p>						<p>Prescribed Action: Any/all liquid petroleum powered generators or pumps (large or small) shall be stored in secondary containment (e.g. plastic totes, sealed metal boxes, drip pans, pre-fabricated portable containment berms or fabricated and lined containment basins) while being stored long term or not in immediate use, wherever these materials are used anywhere on the property. Adequate quantities of absorbent materials shall be stored at all locations where these types of materials are used and stored. Should a spill of these materials occur, absorbent materials will be applied immediately and allowed enough time to absorb as much material as possible. Following treatment, absorbent materials applied as well as any contaminated soil will be removed and disposed of appropriately for the spilled material. See attached BMPs: Generator, Fuel, and Oil Management for further details.</p>	

WDID: _____

Date: _____

Monthly Water Tracking



Month	Total Surface Water Diversion	Water input to Storage by Source	Water use by Source
January			
February			
March			
April			
May			
June			
July			
August			
September			
October			
November			
December			

WDID: _____
Date: _____

Monthly Water Tracking



BMP: Generator, Fuel, and Oil Management

All bulk fuel storage or petroleum products, any/all future petroleum products and other liquid chemicals, including but not limited to diesel, biodiesel, gasoline, and oils shall be stored so as to prevent their spillage, discharge, or seepage into receiving waters. Storage tanks and containers shall be of suitable material and construction to be compatible with the substance(s) stored and conditions of storage such as pressure and temperature. Above ground storage tanks and containers shall be provided with a secondary means of containment for the entire capacity of the largest single container and sufficient cover shall be provided to prevent any/all precipitation from entering said secondary containment vessel.

If the volume of a fuel container is greater than 1,320 gallons, a Spill Prevention, Control, and Countermeasures (SPCC) plan will be required for the use the fuel tank.

On-site storage of petroleum products, or other fuels used for commercial activities may require registration as hazardous materials through the California Environmental Reporting System (CERS). Additionally, the waste oil generated from commercial activities (generators) and their used oil filters are considered hazardous waste and requires additional reporting. The discharger is advised to contact local agencies to find out if such reporting is applicable to currently operations

Used motor oil is recommended to be stored in sealed containers that the oil was originally packaged in, e.g. sealed buckets/quart or gallon jugs, or other sealed containers designed to store motor oil. Stored used oil is recommended to be regularly disposed of at hazardous waste disposal sites. Used oil filters are also recommended to be stored in sealed containers, e.g. sealed plastic totes/buckets, for later disposal at a hazardous waste disposal site. These storage containers are recommended to be stored in structures where they are protected from precipitation.

Further information regarding the State of California's requirements for the managing of Used Oil and Oil Filters can be found by entering the links below or searching the corresponding titles to the links.

California Department of Toxic Substances Control - Used Oil Generator Requirements

- <https://www.dtsc.ca.gov/InformationResources/upload/RAG-UsedOilforGenerators.pdf>

Department of Toxic Substances Control - Managing Used Oil Filters for Generator

- https://www.dtsc.ca.gov/InformationResources/upload/RAG_Used-Oil-Filters_Generators1.pdf

BMP: Generator, Fuel, and Oil Management (Generators and Pumps)

All generators and petroleum powered pumps shall have spill trays or secondary containment placed underneath them when using, fueling, or changing oil on them to prevent the potential for leaching, seepage or spillage of petroleum products. All spill trays and containment structures require cover from precipitation if used or left out over the winter period. All generators and petroleum powered pump locations shall have spill cleanup kits on hand.

Pre-fabricated secondary containment structures and spill trays can be purchased online or from local wholesalers of petroleum products. As an alternative to pre-fabricated secondary containment structures, structures can be constructed from wooden, cinderblock, concrete, or metal frames lined with PVC liners, e.g. pond liner/water bladder material, as long as the containment is fully sealed and constructed in a similar manner to examples of pre-fabricated containment structures found below. Ensure that diked areas are sufficiently impervious to contain discharged chemicals. All containment structures require cover from precipitation to prevent the containment from filling with water. Secondary containment for fuel tanks shall not be constructed.

As an alternative to pre-fabricated spill kits, kits can consist of sealed trashcans or buckets with industrial absorbent material (e.g. cat litter) and shovels, placed nearby any location where generators, pumps, or other petroleum products or chemicals are used.

Examples of industry standard pre-fabricated spill containment and clean-up kits can be found following or entering the links below. Pre-fabricated spill containment and clean-up kits can be purchased online, from Renner Petroleum, or other similar industry providers.

Ultratech Spill Containment

- <http://www.spillcontainment.com/categories/spill-containment/>

New Pig Portable and Collapsible Spill Containment

- <https://www.newpig.com/collapsible-berms/c/5142?show=All>

BMP: Generator, Fuel, and Oil Management



Example of a small, portable, and compact containment berm.



Example of a portable utility spill tray.

BMP: Generator, Fuel, and Oil Management



Example of secondary containment for a fuel tank. This container requires cover from precipitation.



Example of spill pallets for unused or used oil drums and other petroleum products.

BMP: Winterization and Interim Treatments for Erosion Control

- **Roads**
 - Existing or newly installed road surface drainage structures such as water bars, rolling dips, ditch relief culverts, and intentionally in/out-sloped segments of road shall be maintained to ensure continued function of capturing and draining surface runoff.
 - Hand tool kick-outs (lead out ditch) for existing wheel rut, surface run-off confinement.
 - Temporary waterbar/cross-wattles installed on road/trail sections of concentrating surface runoff.
 - Clean existing ditch relief culvert inlets, outlets, and contributing ditch lines of current and potential blockage debris by hand.
 - Hand place energy dissipating rock/small woody debris at ditch relief culvert outlets where erosion is occurring.
 - Wattles/straw bales placed at road runoff delivery sites.
 - Touch-up with hand tools of existing surface drainage structures (kick-outs, rolling dips, and waterbars).
 - Seed and straw un-used, or to be abandoned, road surfaces where erosion is occurring.
 - Frequent use of un-surfaced roads should be avoided, particularly when road surfaces are soft/saturated.

- **Crossings**
 - Clean inlets, outlets, and channels above of current and potential blockage debris by hand.
 - Hand place energy dissipating rock/small woody debris at ditch relief culvert outlets.
 - Hand placement of rock armor around culvert inlets.
 - Install staked wattles along the outboard road edge of out-sloped watercourse crossings where direct delivery of road surface runoff is occurring.
 - Hand placement of rock on crossing fill faces where erosion is/may occur as a result of poor crossing construction.

- **Cultivation Areas**
 - Use hand tools to capture cultivation related soils that are not contained (soil from post-harvest plant removal, soil/planter removal, general spillage).
 - Treat beds, pots, new soil storage piles, spent soil piles, and soil disposal piles with cover crops for soil stability and potentially nitrogen fixing/soil amendment.
 - Bagged potting soil should be covered.
 - Install staked wattles or an earthen berm around cultivation soils piles prior to the winter period, annually.
 - Any soil amendment, fertilizer, herbicide, or pesticide that is not 100% sealed should be stored under cover.
 - Cultivation sites with poor or concentrating drainage can have wattles or bales installed prior to winter to help prevent sediment and nutrients from leaving the site.
 - Plastic netting shall be disposed of or stored where it is inaccessible to wildlife.
 - Tarps/dep covers shall be stored so they cannot be blown away.
 - General waste from growing season gathered up and disposed of.
 - Exposed soil surfaces in the cultivation area, as well as graded fill slopes should be seeded, strawed, mulched, jute netted as needed.

- **General Areas**
 - Remove all refuse prior to leaving property for the season.
 - Back fill pit toilets to be abandoned.

BMP: General Recommendations

- **Fertilizers, soil amendments, and pesticides**
 - Fertilizer, soil amendments, and pesticide use it to be recorded in such a manner that cumulative annual totals are recorded for annual reporting.
 - Store in-use fertilizers in a securable storage container, such as a tote or deck box, adjacent to the mixing tanks.

- **Petroleum products and hazardous materials**
 - Utilize spill trays/containment structures and cover over the containment when using, fueling, changing oil on portable generators or petroleum powered water pumps to prevent the potential for leeching, seepage or spillage of petroleum products.
 - It is recommended that all petroleum products and other chemicals are registered with the California Environmental Reporting System (CERS) to satisfy future licensing requirements.

- **Water storage and Use**
 - Water use shall be designed and metered such that water used for the irrigation of cannabis will be recorded separately from domestic use. Water use for the irrigation of cannabis is to be recorded monthly for annual reporting.
 - Ensure lids are secured on all water storage tanks to prevent wildlife from becoming entrapped within the tank.
 - Install float valves, or implement another equivalent system, on all applicable water storage and transfer tanks to prevent unnecessary water diversion and the overflowing of water tanks.

BMP: General Operations BMPs

- If operations require moving of equipment across a flowing stream, such operations shall be conducted without causing a prolonged visible increase in stream turbidity. For repeated crossings, the operator shall install a bridge, culvert, or rock-lined crossing.
- During construction in flowing water, which can transport sediment downstream, the flow shall be diverted around the work area by pipe, pumping, temporary diversion channel or other suitable means. When any dam or artificial obstruction is being constructed, maintained, or placed in operation, sufficient water shall at all times be allowed to pass downstream to maintain fish life below the dam. Equipment may be operated in the channel of flowing live streams only as necessary to construct the described construction.
- Disturbance or removal of vegetation shall not exceed the minimum necessary to complete operations. The disturbed portion of any stream channel shall be restored to as near their original condition as possible. Restoration shall include the mulching of stripped or exposed dirt areas at crossing sites prior to the end of the work period.
- Structures and associated materials not designed to withstand high seasonal flow shall be removed to areas above the high-water mark before such flows occur.
- No debris, soil, silt, sand, bark, slash, sawdust, rubbish, cement or concrete washing, oil or petroleum products, or other organic or earthen material from any logging, construction, or associated activity of whatever nature shall be allowed to enter into or be placed where it may be washed by rainfall or runoff into waters of the State. When operations are completed, any excess materials or debris shall be removed from the work area. No rubbish shall be deposited within 150 feet of the high-water mark of any stream.

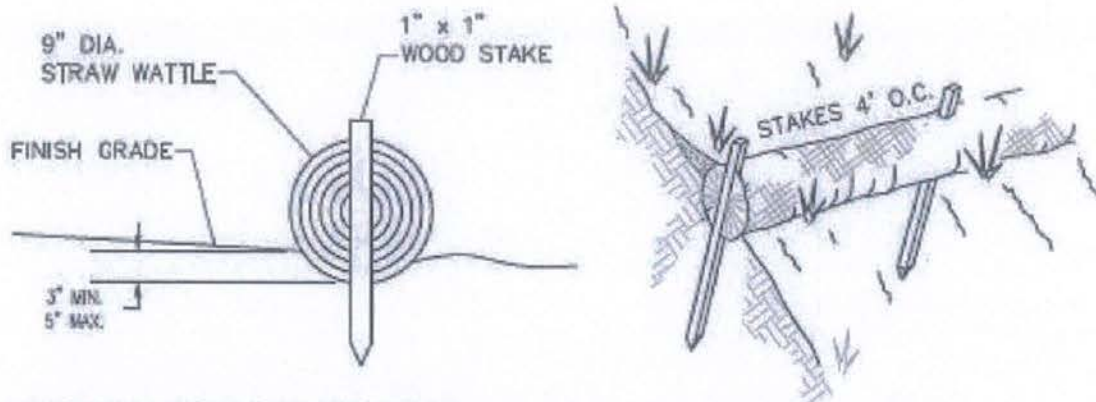
BMP: General Erosion Control

- Timing for soil stabilization measures within the 100 feet of a watercourse or lake: For areas disturbed from May 1 through October 15, treatment shall be completed prior to the start of any rain that causes overland flow across or along the disturbed surface. For areas disturbed from October 16 through April 30, treatment shall be completed prior to any day for which a chance of rain of 30 percent or greater is forecast by the National Weather Service or within 10 days, whichever is earlier.
- Within 100 feet of a watercourse or lake, the traveled surface of logging roads shall be treated to prevent waterborne transport of sediment and concentration of runoff that results from operations. Treatment may consist of, but not limited to, rocking, out sloping, rolling dips, cross drains, water bars, slope stabilization measures, or other practices appropriate to site-specific conditions.
- The treatment for other disturbed areas within 100 feet of a watercourse or lake, including: (A) areas exceeding 100 contiguous square feet where operations have exposed bare soil, (B) approaches to road watercourse crossings out to 100 feet or the nearest drainage facility, whichever is farthest, (C) road cut banks and fills, and (D) any other area of disturbed soil that threatens to discharge sediment into waters in amounts deleterious to the quality and beneficial uses of water, shall be grass seeded and mulched with straw or fine slash. Grass seed shall be applied at a rate exceeding 100 pounds per acre. Straw mulch shall be applied in amounts sufficient to provide at least 2- 4-inch depth of straw with minimum 90% coverage. Slash may be substituted for straw mulch provided the depth, texture, and ground contact are equivalent to at least 2 – 4 inches of straw mulch. Any treated area that has been subject to reuse or has less than 90% surface cover shall be treated again prior to the end of operations.
- Within 100 feet of a watercourse or lake, where the undisturbed natural ground cover cannot effectively protect beneficial uses of water from operations, the ground shall be treated with slope stabilization measures described in #3 above per timing described in #1 above.
- Side cast or fill material extending more than 20 feet in slope distance from the outside edge of a landing which has access to a watercourse or lake shall be treated with slope stabilization measures described in #3 above. Timing shall occur per #1 above unless outside 100 feet of a watercourse or lake, in which completion date is October 15.
- All roads shall have drainage and/or drainage collection and storage facilities installed as soon as practical following operations and prior to either (1) the start of any rain which causes overland flow across or along the disturbed surface within 100 feet of a watercourse or lake protection, or (2) any day with a National Weather Service forecast of a chance of rain of 30 percent or more, a flash flood warning, or a flash flood watch.

BMP: General Erosion Control (Cont.)

- Erosion control and sediment detention devices and materials shall be incorporated into the cleanup/restoration work design and installed prior to the end of project work and before the beginning of the rainy season. Any continuing, approved project work conducted after October 15 shall have erosion control works completed up-to-date and daily.
- Erosion control materials shall be, at minimum, stored on-site at all times during approved project work between May 1 and October 15.
- Approved project work within the 5-year flood plain shall not begin until all temporary erosion controls (straw bales or silt fences that are effectively keyed-in) are installed downslope of cleanup/restoration activities.
- Non-invasive, non-persistent grass species (e.g., barley grass) may be used for their temporary erosion control benefits to stabilize disturbed slopes and prevent exposure of disturbed soils to rainfall.
- Upon work completion, all exposed soil present in and around the cleanup/restoration sites shall be stabilized within 7 days.
- Soils exposed by cleanup/restoration operations shall be seeded and mulched to prevent sediment runoff and transport.
- Straw Wattles (if used) shall be installed with 18 or 24-inch wood stakes at four feet on center. The ends of adjacent straw wattles shall be abutted to each other snugly or overlapped by six inches. Wattles shall be installed so that the wattle is in firm contact with the ground surface.

BMP: General Erosion Control (Cont.)

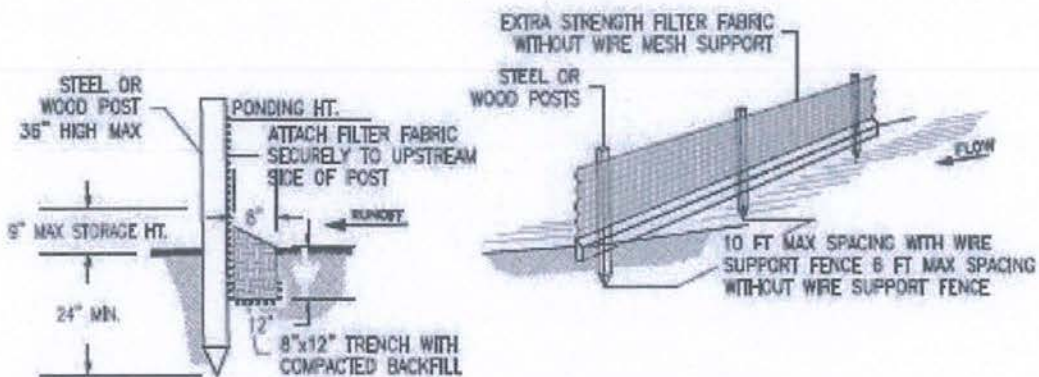


STRAW WATTLE NOTES:

1. STRAW WATTLES SHALL BE INSTALLED WITH 18 OR 24 INCH WOOD STAKES AT FOUR FEET ON CENTER. THE ENDS OF ADJACENT STRAW WATTLES SHALL BE ABUTTED TO EACH OTHER SNUGLY OR OVERLAPPED BY SIX INCHES.
2. STRAW ROLL INSTALLATION REQUIRES THE PLACEMENT AND SECURE STAKING OF THE ROLL IN A TRENCH, 3"-5" DEEP. RUNOFF MUST NOT BE ALLOWED TO RUN UNDER OR AROUND THE ROLL.

STRAW WATTLE INSTALLATION DETAIL

NTS



SILT FENCE NOTES:

1. THE CONTRACTOR SHALL INSPECT AND REPAIR FENCE AFTER EACH STORM EVENT.
2. CONTRACTOR SHALL REMOVE SEDIMENT AS NECESSARY. REMOVED SEDIMENT SHALL BE DEPOSITED TO AN AREA THAT WILL NOT CONTRIBUTE SEDIMENT OFF-SITE AND IN AN AREA THAT CAN BE PERMANENTLY STABILIZED.
3. SILT FENCE SHALL BE PLACED ON SLOPE CONTOURS TO MAXIMIZE PONDING EFFICIENCY.

SILT FENCE DETAILS

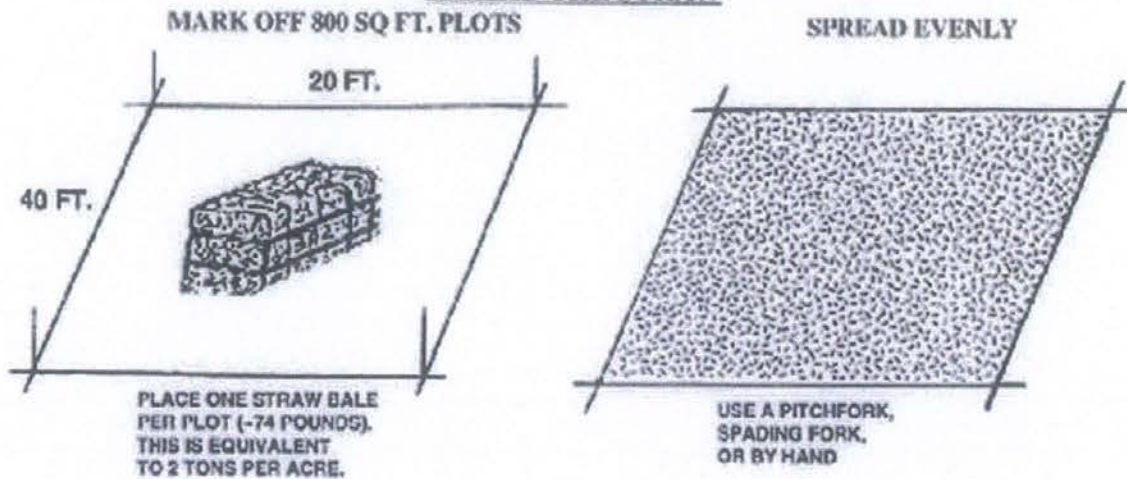
NTS

BMP: General Erosion Control (Cont.)

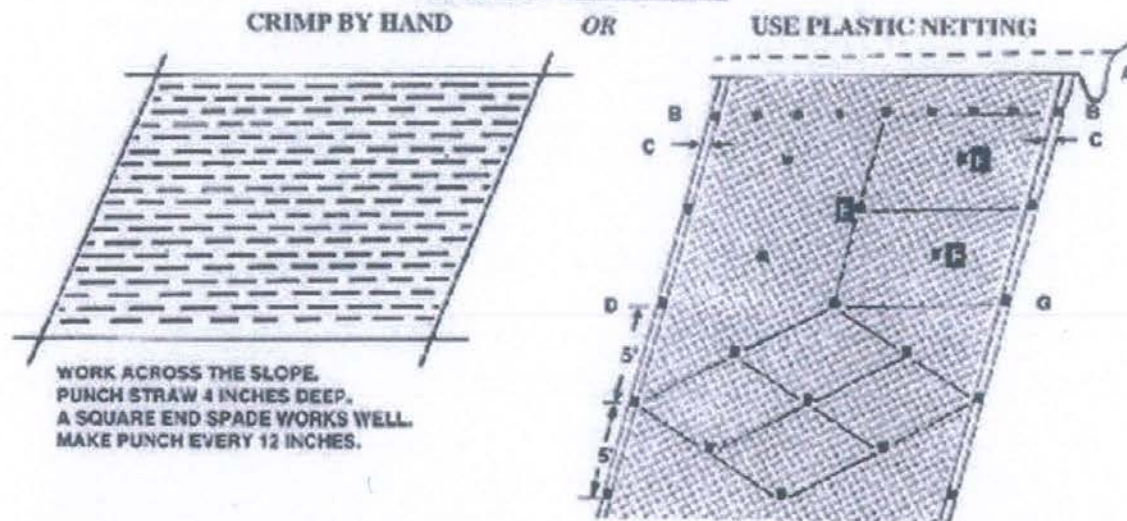


BMP: General Erosion Control (Cont.)

SPREAD THE STRAW



ANCHOR THE STRAW



A. LAY BIRD CONTROL NETTING OR SIMILAR MATTING IN STRIPS DOWN THE SLOPE OVER THE STRAW. BURY UPPER END IN 6-8 INCH DEEP AND WIDE TRENCH.. MOST NETTING COMES IN 14 TO 17 FT. WIDE ROLLS.

B. SECURE THE UPPER END WITH STAKES EVERY 2 FEET.

C. OVERLAP SEAMS ON EACH SIDE 4-5 INCHES.

D. SECURE SEAMS WITH STAKES EVERY 5 FEET.

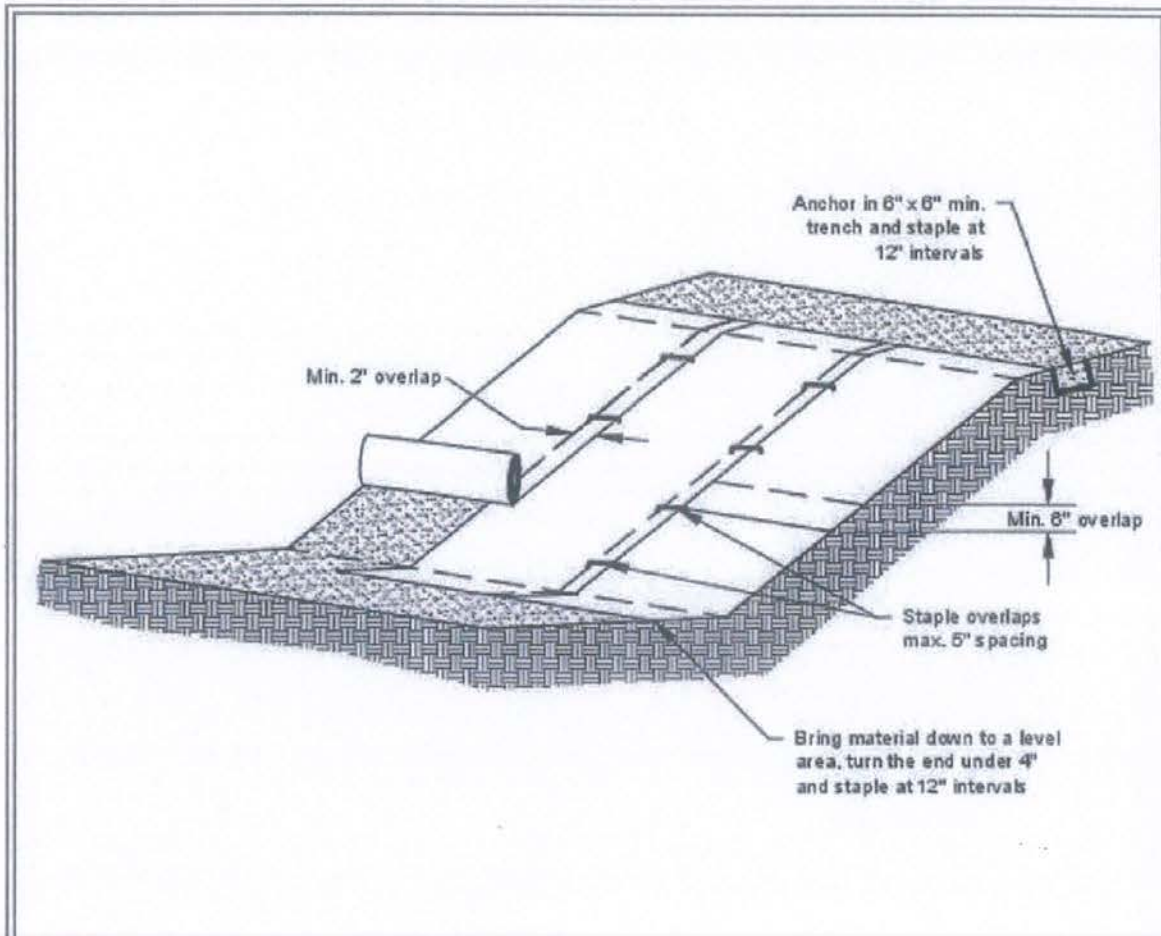
E. STAKE DOWN THE CENTER EVERY 5 FEET.

F. STAKE MIDDLES TO CREATE DIAMOND PATTERN THAT PROVIDES STAKES SPACED 4-5 FEET APART.

G. USE POINTED 1X2 INCH STAKES 8 TO 9 INCHES LONG. LEAVE 1 TO 2 INCH TOP ABOVE NETTING, OR USE "U" SHAPED METAL PINS AT LEAST 9 INCHES LONG.

NOTE: WHEN JOINING TWO STRIPS, OVERLAP UPPER STRIP 3 FEET OVER LOWER STRIP AND SECURE WITH STAKES EVERY 2 FEET LIKE IN "B" ABOVE

BMP: General Erosion Control (Cont.)



Notes:

1. Slope surface shall be smooth before placement for proper soil contact.
2. Stapling pattern as per manufacturer's recommendations.
3. Do not stretch blankets/mattings tight - allow the rolls to mold to any irregularities.
4. For slopes less than 3H:1V, rolls may be placed in horizontal strips.
5. If there is a berm at the top of the slope, anchor upslope of the berm.
6. Lime, fertilize, and seed before installation. Planting of shrubs, trees, etc. should occur after installation.

NOT TO SCALE



**DEPARTMENT OF
ECOLOGY**
State of Washington

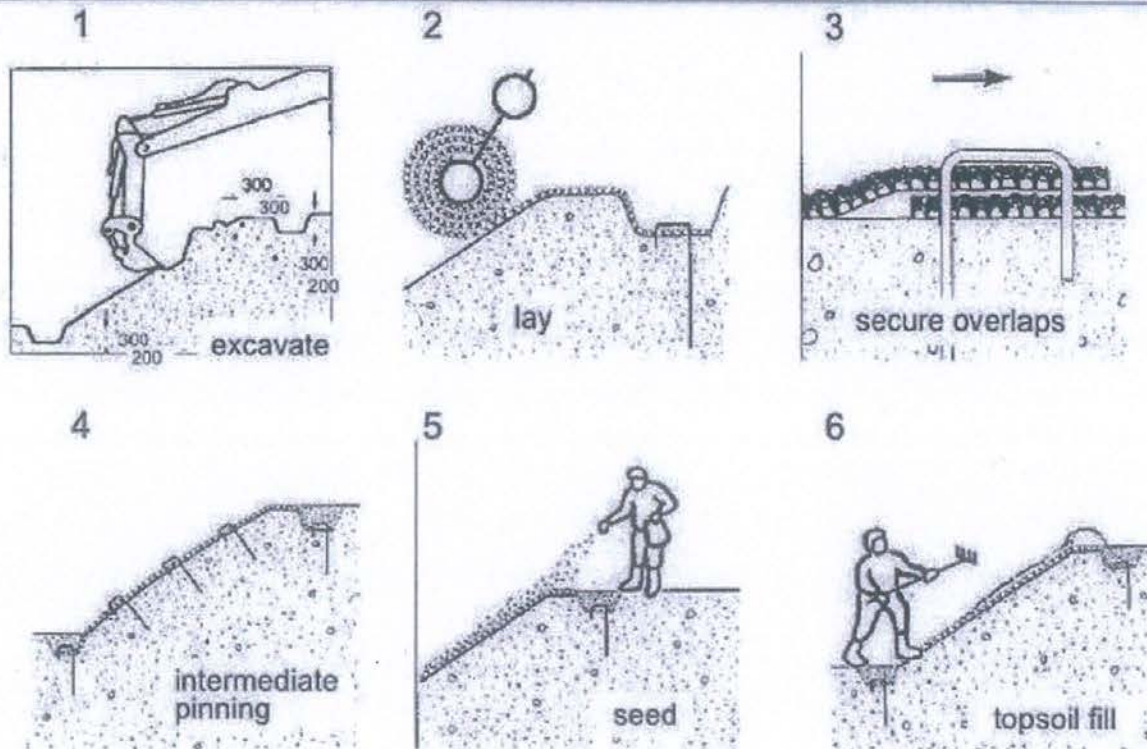
Slope Installation

Revised June 2018

Please see <http://www.ecy.wa.gov/copyright.html> for copyright notice including permissions, limitation of liability, and disclaimer.

BMP: General Erosion Control (Cont.)

Installation of a geosynthetics mat - Enkamat



Erosion Control Measures (Cont.)

Erosion Control Matting & Silt Fencing



Jute netting & Straw-wattles



BMP: General Erosion Control (Cont.)

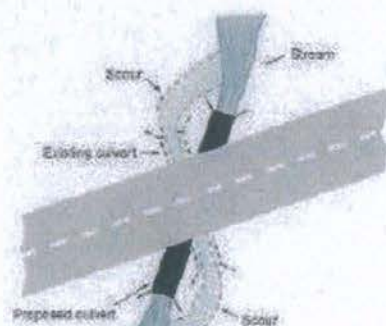
TABLE 24. Guidelines for erosion and sediment control application

Timing of application	Technique	Portion of road and construction area treated
Erosion control during construction	Hydromulching, hydroseeding	Road fill slopes, cut slopes, bare soil areas
	Dry seeding	Road fill slopes, cut slopes, bare soil areas
	Wood chip, straw, Excelsior or tackified mulch	Road fill slopes, cut slopes, bare soil areas
	Straw wattles	Road fill slopes and cut slopes
	Gravel surfacing	Road, landing and turnout surfaces
	Dust palliative	Road surfaces
Sediment control during construction	Minimize disturbance (soil and vegetation)	All areas peripheral to construction
	Sediment basin	Roadside ditches, turnouts and small stream crossings
	Sediment traps (e.g., silt fences, straw bales barriers, woody debris barriers)	Road fill slopes, cutbanks, bare soil areas and ditches
	Straw bale dams	Ditches and small streams
	Sumps and water pumps	Stream channels and stream crossings
	Streamflow diversions (e.g., temporary culverts, flex pipe, etc.)	Stream channels and stream crossings
Permanent erosion control	Surface diversion and dispersion devices (pipes, ditches, etc.)	All disturbed bare soil areas
	Road shaping	Road and landing surfaces
	Gravel surfacing	Road, landing and turnout surfaces
	Bituminous or asphalt surfacing	Road surface
	Rolling dips	Road surface
	Ditch relief culverts	Roadbed and road fill
	Downspouts and berm drains	Road fill slopes
	Waterbars	Road and landing surfaces
	Berms	Road surface and roadside areas
	Ditches	Road and landing surfaces
	Riprap	Road fill slopes, stream crossing fills, cutbanks, stream and lake banks
	Soil bioengineering	Road fill slopes, cut slopes, stream crossings, streambanks
	Tree planting	Road fill slopes, cutbanks, bare soil areas, stream crossings, streambanks

HANDBOOK FOR FOREST, RANCH AND RURAL ROADS

BMP: Permanent Culvert Crossing

- New culvert installations shall be sized to accommodate flows associated with a 100-year storm event.
- If the new culvert is replacing a poorly installed old culvert, the crossing may need to be abandoned to the following standard:
 - When fills are removed they shall be excavated to form a channel that is as close as feasible to natural watercourse grade and orientation, and that is wider than the natural channel.
 - Excavated banks shall be laid back to a 2:1 (50%) or natural slope.
- New culverts shall be placed at stream gradient, or have downspouts, or have energy dissipaters at outfall.
 - Align culverts with the natural stream channel orientation to ensure proper function, prevent bank erosion, and minimize debris plugging. See Figure 97 below.
 - Place culverts at the base of the fill and at the grade of the original streambed or install a downspout past the base of the fill. Downspouts should only be installed if there are no other options.
 - Culverts should be set slightly below the original stream grade so that the water drops several inches as it enters the pipe.
 - Culvert beds should be composed of rock-free soil or gravel, evenly distributed under the length of the pipe.
 - Compact the base and sidewall material before placing the pipe in its bed.
 - Lay the pipe on a well-compacted base. Poor basal compaction will cause settling or deflection in the pipe and can result in separation at a coupling or rupture in the pipe wall.
 - Backfill material should be free of rocks, limbs, or other debris that could dent or puncture the pipe or allow water to seep around the pipe.
 - Cover one end of the culvert pipe, then the other end. Once the ends are secure, cover the center.
 - Tamp and compact backfill material throughout the entire process, using water as necessary for compaction.
 - Backfill compacting will be done in 0.5 – 1.0 foot lifts until 1/3 of the diameter of the culvert has been covered.
 - Push layers of fill over the crossing to achieve the final design road grade, road fill above the culvert should be no less than one-third to one-half the culvert diameter at any point on the drivable surface.
- Critical dips shall be installed on culvert crossings to eliminate diversion potential. Refer to Figure 84 below.
- Road approaches to crossings shall be treated out to the first drainage structure (i.e. waterbar, rolling dip, or hydrologic divide) to prevent transport of sediment.
- Road surfaces and ditches shall be disconnected from streams and stream crossings to the greatest extent feasible. Ditches and road surfaces that cannot be feasible disconnected from streams or stream crossings shall be treated to reduce sediment transport to streams.
- If downspouts are used, they shall be secured to the culvert outlet and shall be secure on fill slopes.
- Culverts shall be long enough so that road fill does not extend or slough past the culvert ends.
- Inlet of culverts, and associate fill, shall be protected with appropriate measures that extend at least as high as the top of the culvert.
- Outlet of culverts shall be armored with rock if road fill sloughing into channel can occur.
- Armor inlets and outlets with rock, or mulch and seed with grass as needed (not all stream crossings need to be armored).
- Where debris loads could endanger the crossing, a debris catchment structure shall be constructed upstream of the culvert inlet.
- Bank and channel armoring may occur, when appropriate, to provide channel and bank stabilization.



HANDBOOK FOR FOREST, RANCH AND RURAL ROADS

FIGURE 97. Culvert alignment should be in relation to the stream and not the road. It is important that the stream enters and leaves the culvert in a relatively straight horizontal alignment so streamflow does not have to turn to enter the inlet or discharge into a bank as it exits. This figure shows a redesigned culvert installation that replaces the bending alignment that previously existed. Channel turns at the inlet increase plugging potential because wood going through the turn will not align with the inlet. Similarly, channel turns at the inlet and outlet are often accompanied by scour against the channel banks (Wisconsin Transportation Information Center, 2004).

BMP: Permanent Culvert Crossing Design (Critical Dip and Hydrologic Disconnect Placement)

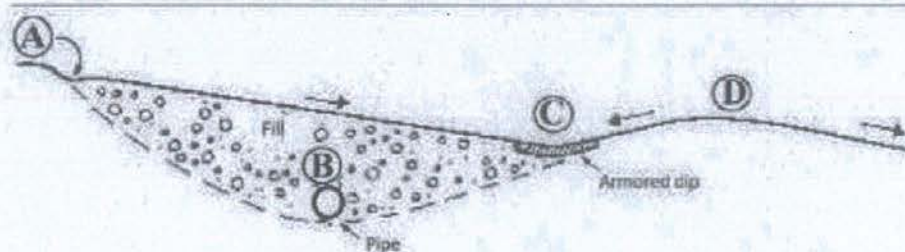
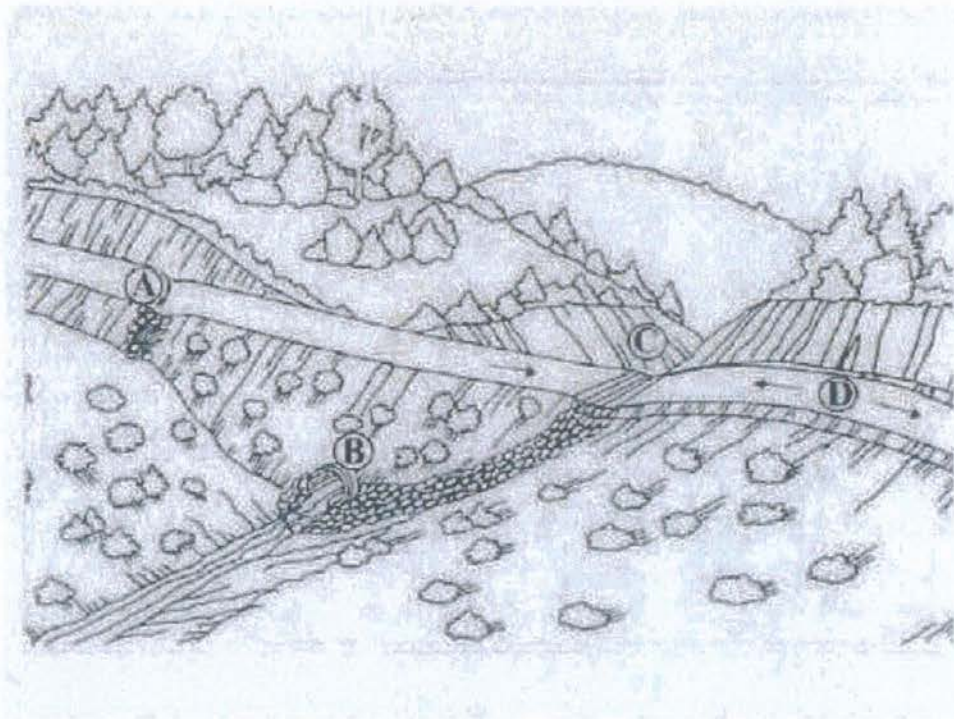
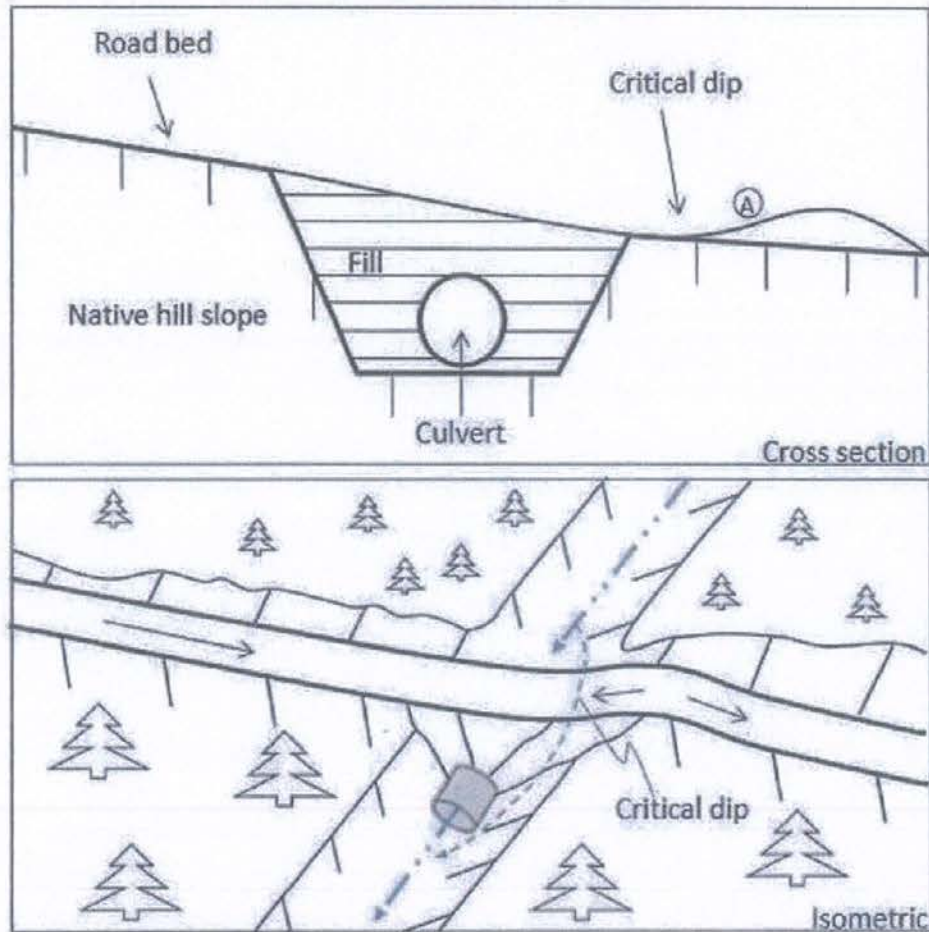
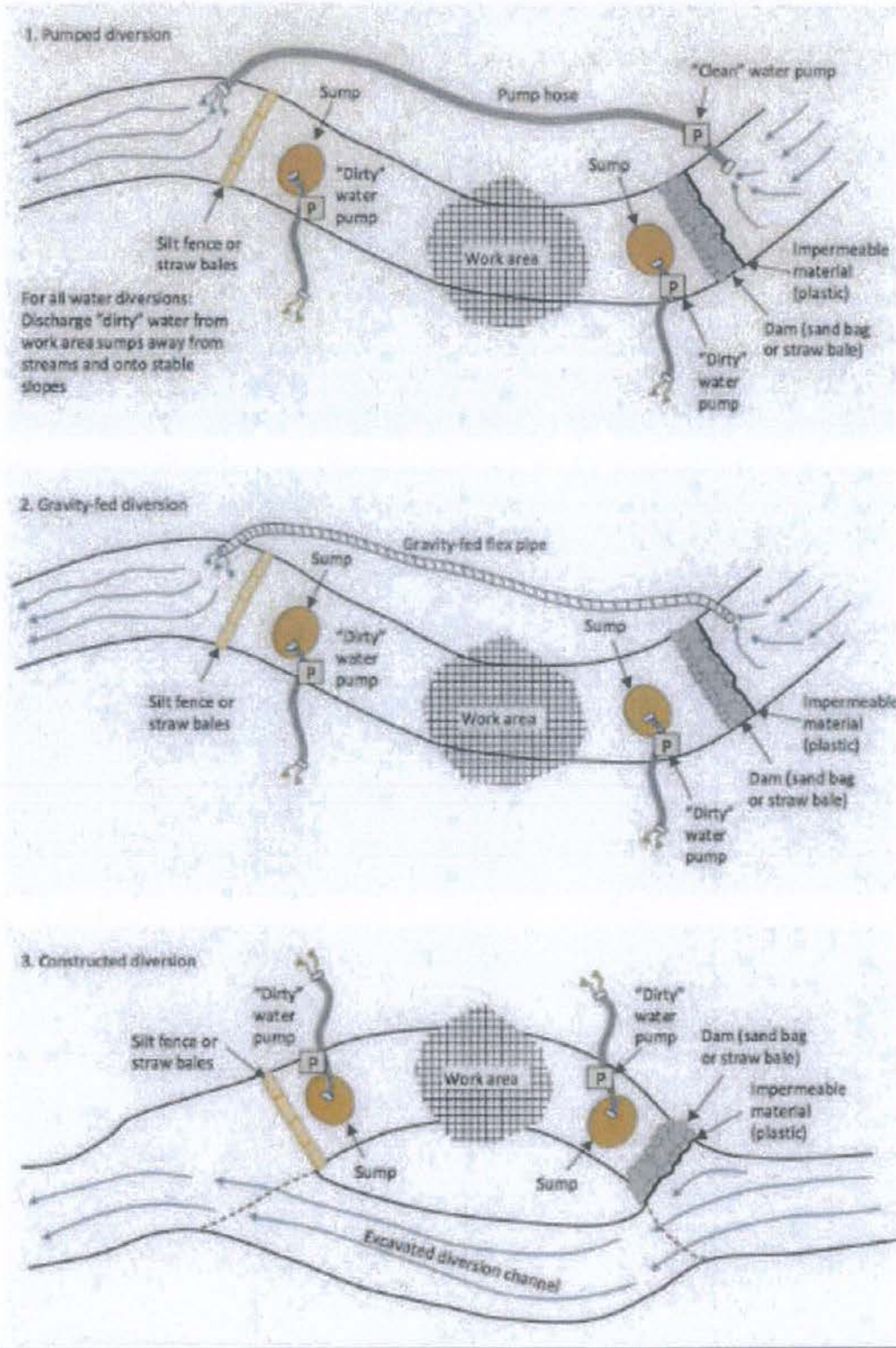


FIGURE 84. Critical dips or dipped crossing fills should be centered near a stream crossing's down-road hinge line, not over the centerline of the crossing where overtopping could cause washout or severe erosion of the fill. If the stream crossing culvert (B) plugs, water will pond behind the fill until reaching the critical dip or low point in the crossing (C) and flowing back down into the natural stream channel. The down-road ditch must be plugged to prevent streamflow from diverting down the ditch line. For extra protection in this sketch, apron armor has been placed at the critical dip outfall and extending downslope to the stream channel. This is only required or suggested on stream crossings where the culvert is highly likely to plug and the crossing fill overtopped. The dip at the hinge line is usually sufficient to limit erosional damage during an overtopping event. Road surface and ditch runoff is disconnected from the stream crossing by installing a rolling dip and ditch relief culvert just up-road from the crossing (A) (Keller and Sherar, 2003).

BMP: Permanent Culvert Crossing Design (Critical Dip)**Typical Critical Dip Design for Stream Crossings with Diversion Potential****Critical Dip Construction:**

1. Critical dip will be constructed on the lower side of crossing.
2. Critical dip will extend from the cutbank to the outside edge of the road surface. Be sure to fill inboard ditch, if present.
3. Critical dip will have a reverse grade (A) from cutbank to outside edge of road to ensure flow will not divert outside of crossing.
4. The rise in the reverse grade will be carried for about 10 to 20 feet and then return to original slope.
5. The transition from axis of bottom, through rising grade, to falling grade, will be in the road distance of at least 15 to 30 feet.
6. Critical dips are usually built perpendicular to the road surface to ensure that flow is directed back into the stream channel.

**BMP: Permanent Culvert Crossing Design
(Cofferdam Construction and Use Specifications)**



BMP: Permanent Culvert Crossing Design
(Cofferdam Construction and Use Specifications)



FIGURE 197. Flex pipe stream diversion around a road construction site. The inlet to this 6 inch diameter flex pipe inlet collects clear streamflow from a retention dam above the project site and gravity leads it around the project area and back into the natural channel downstream from construction work (see photo).



FIGURE 198. Sand bag retention dam on this small stream was used to pond streamflow so it could be pumped around a culvert installation site. The green intake hose is screened to keep out rocks and debris while the red pump hose extends several hundred feet around the project work area.



FIGURE 199. For larger streams, pump trucks, large pumps or multiple small pumps can be used to pump streamflow around project work sites. Here, a pump truck is used to temporarily divert flow in a fish bearing stream where dual culverts are being replaced with a rail-over bridge. Young fish were removed from this fish bearing stream before project work started.

BMP: Permanent Culvert Crossing Design (Culvert Orientation)

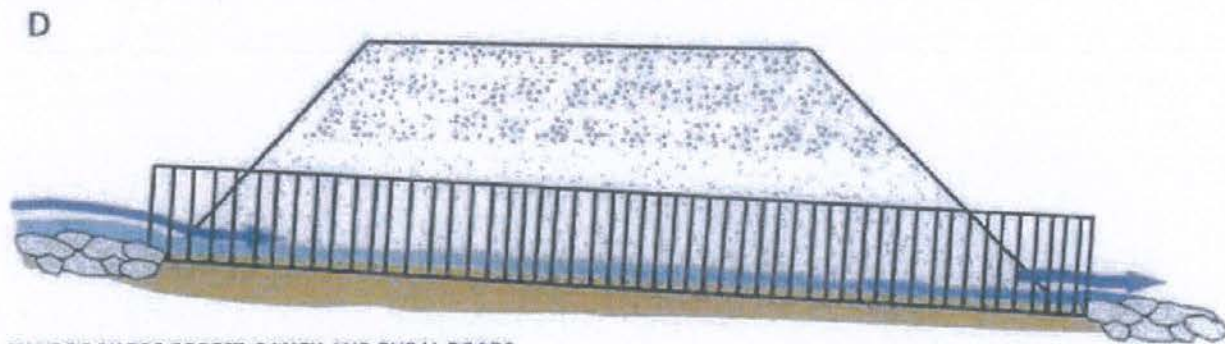
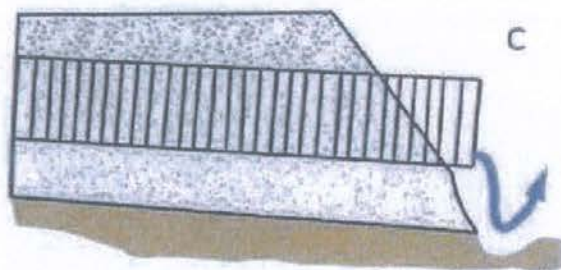
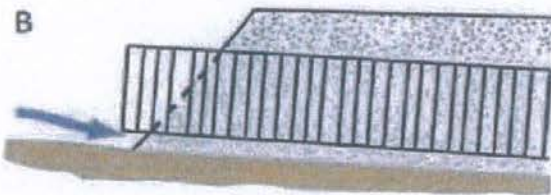
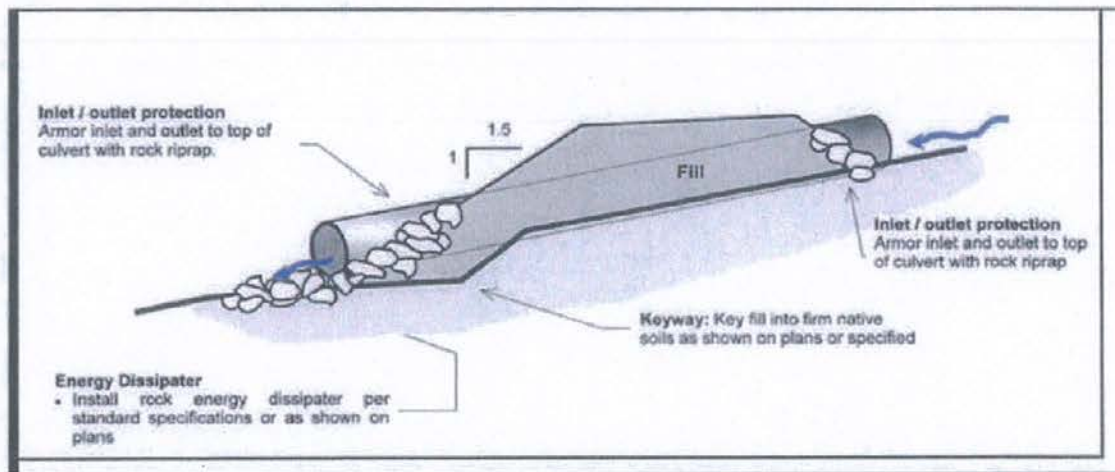
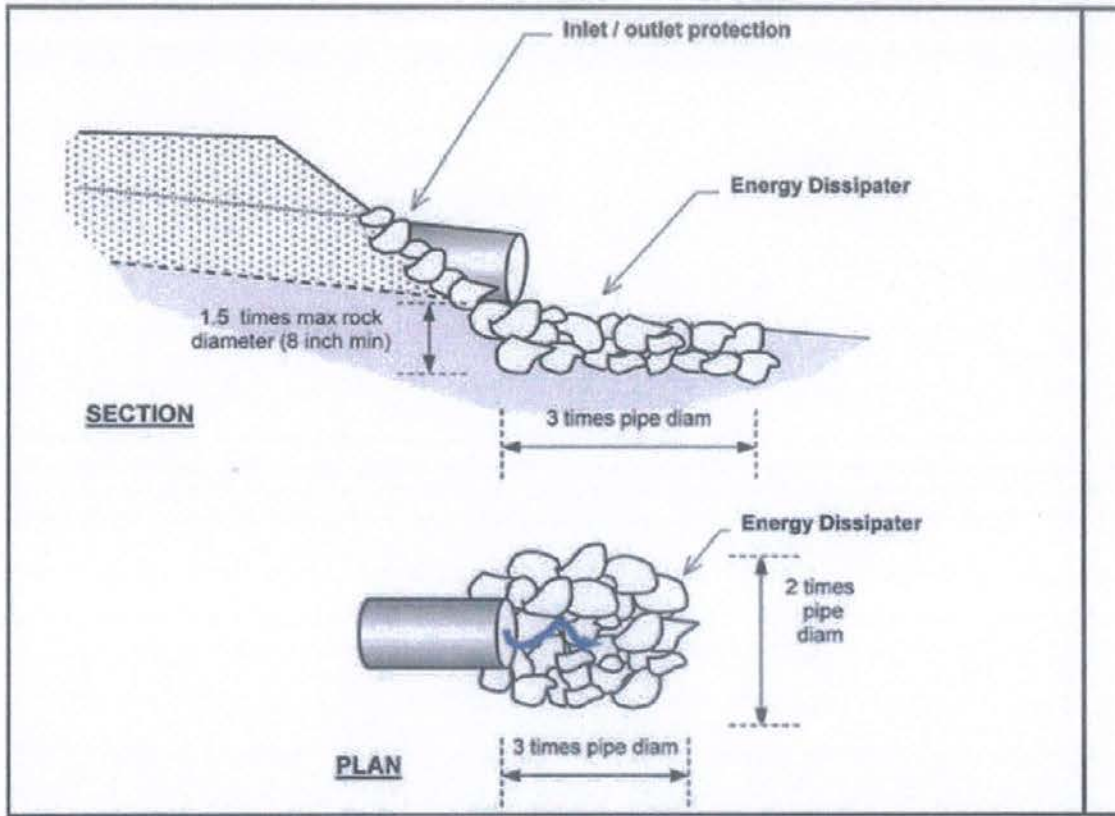


FIGURE 155. Proper culvert installation involves correct culvert orientation, setting the pipe slightly below the bed of the original stream, and backfilling and compacting the fill as it is placed over the culvert. Installing the inlet too low in the stream (A) can lead to culvert plugging, yet if set too high (B) flow can undercut the inlet. If the culvert is placed too high in the fill (C), flow at the outfall will erode the fill. Placed correctly (D), the culvert is set slightly below the original stream grade and protected with armor at the inlet and outlet. Culverts installed in fish-bearing stream channels must be inset into the streambed sufficiently (>25% embedded) to have a natural gravel bottom throughout the culvert (Modified from: MDSL, 1991).

BMP: Permanent Culvert Crossing Design (Inlet and Outlet Armoring)



Riprap installed to protect the inlet and outlet of a stream crossing culvert from erosion or for energy dissipation should be keyed into the natural channel bed and banks to an approximate depth of about 1.5x the maximum rock thickness. Riprap should be placed at least up to the top of the culvert at both the inlet and outlet to protect them from splash erosion and to trap any sediment eroded from the newly constructed fill slope above.

BMP: Permanent Culvert Crossing Design (Inlet and Outlet Armoring) Cont.

- Inlets of culverts and associate fills shall be protected with rock armoring that extends at least as high as the top of the culvert.
- Outlets of culverts shall be provided a rock energy dissipater at the outfall of the culvert.
- Outlets of culverts and associate fills shall be protected with rock armoring that extends at least as high as the top of the culvert if road fill sloughing into channel can occur.
- Prior to inlet and outlet rocking, the inlet and outlets shall be prepared. Preparation will include removal of vegetation and stored materials from the inlet and outlet.
- Inlets may require construction of an inlet basin.
- Slopes at the outlet should be shaped to a 2:1 or natural slope prior to placing rock armor.
- Rock used at culvert inlets and outlets should be a matrix of various sized rocks and rip-rap that range from a 3" dia. to a 2' dia.
- The largest rocks should be places at the base of the culvert or fill. Incrementally smaller rocks shall be placed over the larger rocks at the armoring extend up the slope. Voids and spaces shall be back filled with smaller gravels and rocks.

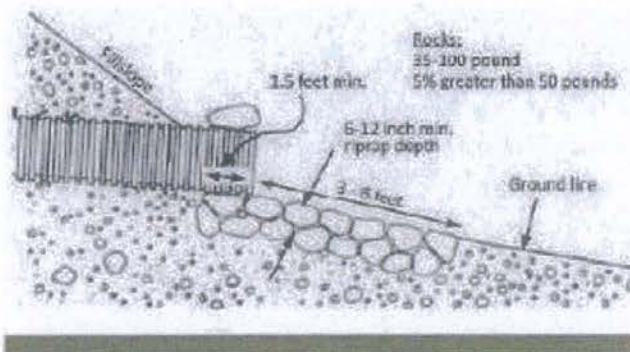


FIGURE 107A. Riprap armor at culvert outlet (Modified from: Keller et al., 2011).

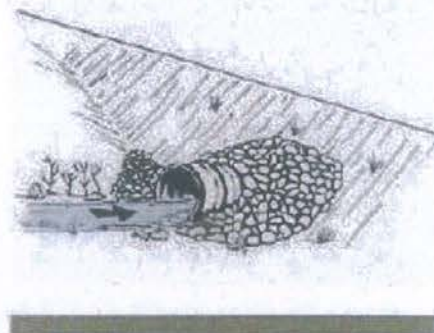


FIGURE 107B. Riprap armor at culvert inlet (Keller and Sherat, 2003).

HANDBOOK FOR FOREST, RANCH AND RURAL ROADS

BMP: Stream Bank Armoring (Riprap)

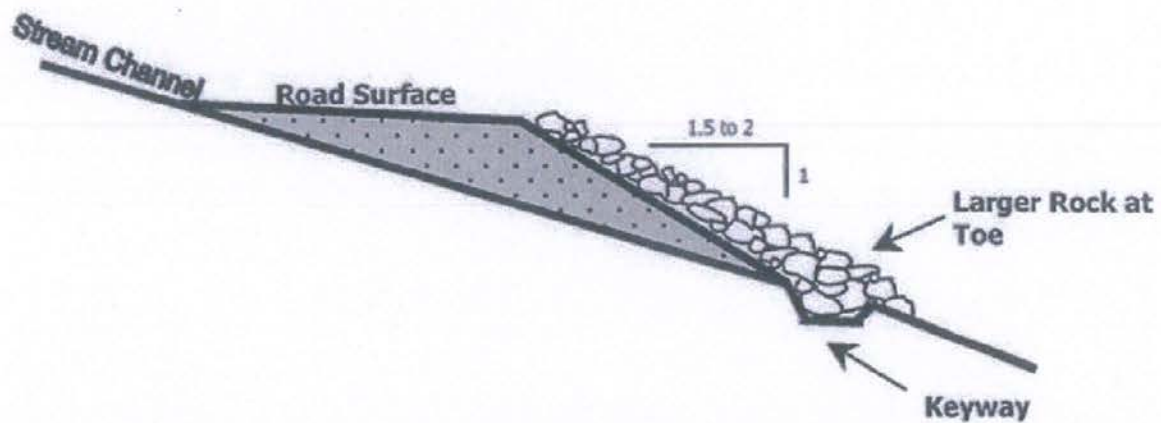
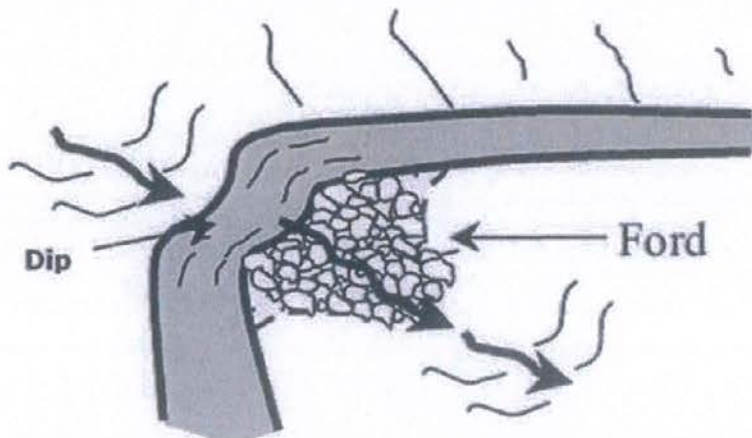
- Riprap should be installed on top of geotextile fabric or a clean mixture of coarse gravel and sand.
- The riprap should be keyed into the streambed and extend below the maximum expected scour depth with an adequately sized key base width at a thickness of a minimum of 2x the median (D50) rock diameter with the largest stone sizes placed at the base of the riprap structure.
- The armor should be set into the streambank so it does not significantly protrude into, or constrict, the natural channel, or otherwise reduce channel capacity.
- The riprap should extend along the length of unstable or over steepened bank and up the bank sufficiently to encompass the existing bank instability and/or design flood elevations.

BMP: Rocked Ford

- Rocked fords are drainage structures designed to carry watercourses across roads where culvert crossings are not feasible or un-necessary.
- In channel constructed fords shall be of appropriate material that shall withstand erosion by expected velocities and placed in a U-shaped channel to create a drivable crossing.
 - The road shall dip into and out of the rocked ford to minimize diversion potential. Construct a broad rolling dip across the roadbed, centered at the crossing, which is large enough to contain the expected 100-yr flood discharge while preventing flood flow from diverting down the road or around the rock armor.
- The road surface at the ford shall be constructed with clean rock. The rock shall be applied to a minimum depth of 6 inches.
 - A range of interlocking rock armor sizes should be selected and sized so that peak flows will not pluck or transport the armor off the roadbed or the sloping fill face of the armored fill.
- The ford's outlet shall be rock armored to resist downcutting and erosion.
 - *Excavate the keyway and armored area* - Excavate a two to three-foot-deep "bed" into the dipped road surface and adjacent fillslope (to place the rock in) that extends from approximately the middle of the road, across the outer half of the road, and down the outboard road fill to where the base of the fill meets the natural channel. At the base of the fill, excavate a keyway trench extending across the channel bed.
 - *Armor the basal keyway* - Put aside the largest rock armoring to create the buttresses. Use the largest rock armor to fill the basal trench and create a buttress at the base of the fill. This should have a "U" shape to it and it will define the outlet where flow leaves the armored fill and enters the natural channel.
 - *Armor the fill* - Backfill the fill face with the remaining rock armor making sure the final armor is unsorted and well placed, the armor is two coarse-rock layers in thickness, and the armored area on the fill face also has a "U" shape that will accommodate the largest expected flow.
 - *Armor the top of the fill* - Install a second trenched buttress for large rock at the break-in-slope between the outboard road edge and the top of the fill face.
- If water is expected during the time of use, an adequately sized pipe shall be installed to handle the flow if present (min. 6 inch).
 - The pipe shall be laid over the rocked ford surface.
 - The inlet should be at grade with the upstream flow.
 - The outlet shall drain onto the outlet armoring of the rocked ford.
 - A layer of clean rock/gravel shall be installed over the pipe to establish the running surface of the truck road.
 - Following use, the temporary pipe shall be removed and the placed rock/gravel shall be graded out of the ford and used on the approaches.
 - No significant alteration to the bed and bank of the stream shall occur.
- Road approaches to rocked fords shall be rock surfaced out to the first drainage structure (i.e. waterbar) or hydrologic divide to prevent transport of sediment using rock.
- Bank and channel armoring may occur when appropriate to provide channel and bank stabilization.
- Road approach rock and rock ford armoring shall be reapplied following use as needed to maintain a permanent crossing.

BMP: Rocked Ford (Cont.)

FORD: A large dip is graded into the road at the axis of the stream channel. The outside fill face is dished out to form a spillway with large rock. On large watercourses, rock is keyed several feet into firm native soils. The road surface is rocked with 6" of minus rock.



BMP: Armored Ford (Fill)

- Armored fords are drainage structures designed to carry watercourses across roads.
- Armored fords shall have a U-shaped channel to create a drivable crossing.
 - The road shall dip into and out of the armored ford to minimize diversion potential. Construct a broad rolling dip across the roadbed, centered at the crossing, which is large enough to contain the expected 100-yr flood discharge while preventing flood flow from diverting down the road or around the rock armor.
- The road surface at the armored ford shall utilize native soils.
- The ford's inlet shall be rock armored if a threat of head cutting exists.
 - *Excavate the keyway* - Excavate a one to three-foot-deep "bed" into the inboard edge of the road
 - *Armor the basal keyway* - place various sized rock in the constructed keyway to prevent head cutting. Use the largest rock armor to fill the keyway trench and create a buttress along the inboard edge of the road. This should have a "U" shape to it and it will define the inlet where flow leaves the natural channel and enters the road.
- The ford's outlet shall be rock armored to resist downcutting and erosion.
 - *Excavate the keyway and armored area* - Excavate a two to three-foot-deep "bed" into the dipped road surface and adjacent fillslope (to place the rock in) that extends from approximately the middle of the road, across the outer half of the road, and down the outboard road fill to where the base of the fill meets the natural channel. At the base of the fill, excavate a keyway trench extending across the channel bed.
 - *Armor the basal keyway* - Put aside the largest rock armoring to create the buttresses. Use the largest rock armor to fill the basal trench and create a buttress at the base of the fill. This should have a "U" shape to it and it will define the outlet where flow leaves the armored fill and enters the natural channel.
 - *Armor the fill* - Backfill the fill face with the remaining rock armor making sure the final armor is unsorted and well placed, the armor is two coarse-rock layers in thickness, and the armored area on the fill face also has a "U" shape that will accommodate the largest expected flow.
 - *Armor the top of the fill* - Install a second trenched buttress for large rock at the break-in-slope between the outboard road edge and the top of the fill face.
- If water is expected during the time of use, an adequately sized pipe shall be installed to handle the flow if present (min. 6 inch).
 - The pipe shall be laid over the armored ford surface.
 - The inlet should be at grade with the upstream flow.
 - The outlet shall drain onto the outlet armoring of the rock armored ford.
 - A layer of clean native shall be installed over the pipe to establish the running surface of the truck road.
 - Following use, the temporary pipe shall be removed and the placed native soil shall be removed and drifted along the approaches.
 - No significant alteration to the bed and bank of the stream shall occur.
- Road approaches to armored fords shall be treated with seed and straw mulch out to the first drainage structure (i.e. waterbar) or hydrologic divide to prevent transport of sediment pursuant to Item 18, Section II.
- Bank and channel armoring may occur when appropriate to provide channel and bank stabilization.
- Armored ford armoring shall be reapplied following use as needed to maintain a permanent crossing.

BMP: Armored Ford [Fill] (Cont.)

FIGURE 120. *This armored fill crossing of a steep, ephemeral stream was constructed to provide a low maintenance crossing. The crossing has been deeply dipped to reduce the volume of road fill and to eliminate the potential for stream diversion. The fill slope has been heavily armored through the axis of the crossing to contain flood flows and prevent down-cutting. Armored fills cannot be used on fish bearing streams.*

HANDBOOK FOR FOREST, RANCH AND RURAL ROADS

BMP: Armored Ford [Fill] (Cont.)



FIGURE 121D. Wet graded rock armor is then backfilled into the structure and spread across the breadth of the U-shaped stream crossing, and about one-third the way up the roadbed, so that streamflow will only flow over or come in contact with resistant armor material. The armor must be spread and compacted across the design width of the expected flood flow channel width so peak flows will not flank the armored structure.



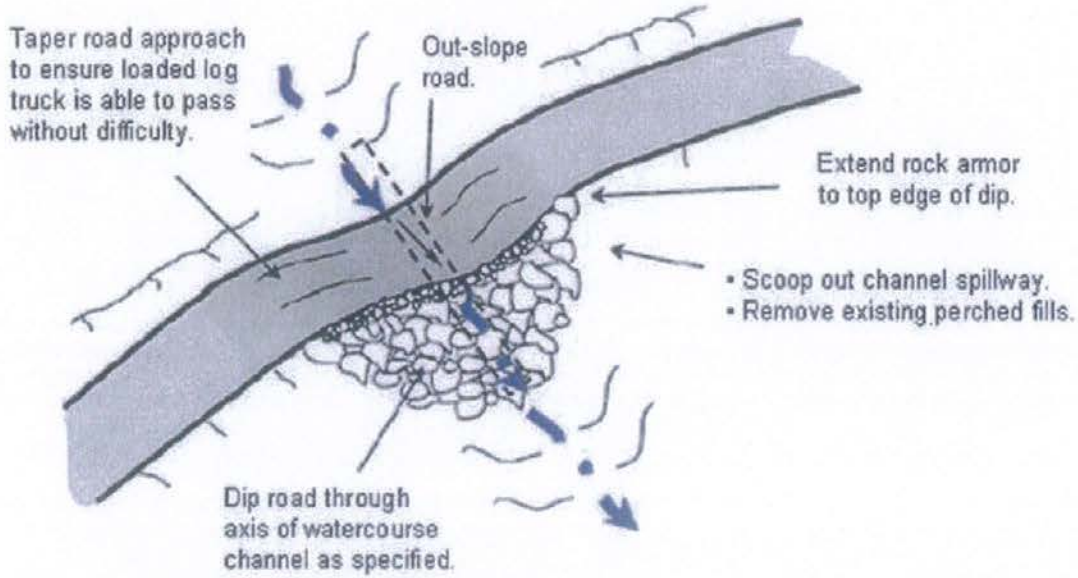
FIGURE 121E. Two weeks after this armored fill was constructed, a storm flow event occurred and the structure maintained its function and integrity. The road approaches had not yet been compacted or surfaced with road rock.



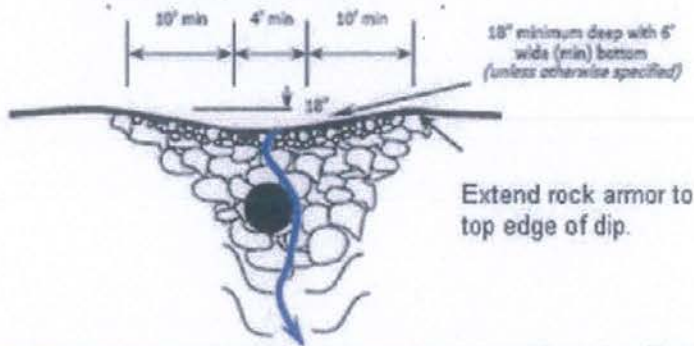
FIGURE 121F. The same armored fill as it appeared after the first winter flood flows. No maintenance was required to reopen the road. It is also clear that no stream diversion is possible at this stream crossing site, and the volume of fill within the crossing has been reduced to the minimum amount needed to maintain a relatively smooth driving surface on this low volume road.

BMP: Vented Ford

Vented Ford



Dip area to accommodate a culvert sized for 100-year flow (minimum dimensions given below).



LIP

- Use smaller rock at lip of ford.
- Fill voids with smaller rock to prevent piping around the larger rock.



BMP: Crossing Abandonment

- Excavate and removing all fill materials placed in the stream channel when the crossing was originally built.
- Excavated banks shall be laid back to a 2:1 (50%) or natural slope to prevent slumping and soil movement.
- Fill material should be excavated to recreate the original channel grade (slope) and orientation.
- All bare soils should then be mulched, seeded, and planted to minimize erosion until vegetation can protect the soil surface.
- The approaching road segments shall be cross-road(waterbars) drained to prevent road runoff from discharging across the freshly excavated channel sideslopes.
- When fills are removed, they shall be excavated to form a channel that is as close as feasible to natural watercourse grade and orientation.
- The excavated channel bed should be as wide, or slightly wider than, the original watercourse channel.
 - This can be better determined by observing the channel width of the watercourse up slope of crossing to be removed at a point in which the crossing or any other disturbance has not affected the natural channel slope and width.
- Temporary crossings shall be removed by November 15.
 - Any temporary culvert crossing left in after October 15 or installed between October 15 and May 1, shall be sized to accommodate the estimated 100-year flow.
- In certain situations, bank and channel rock and woody debris armoring may be appropriate to provide channel and bank stabilization.

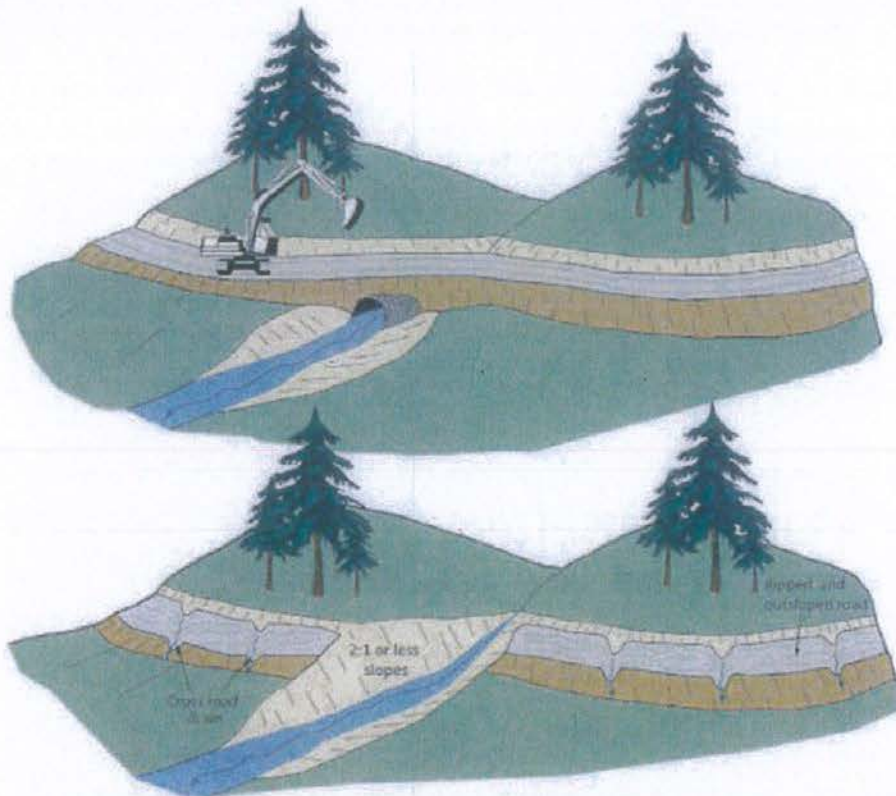


FIGURE 263. On roads that are to be closed (decommissioned), all stream crossing culverts and fills should be removed. Stream crossing excavations are best performed using an excavator. The original channel should be excavated and exhumed down to the former streambed, with a channel width equal or greater than the natural channel above and below the crossing. Sideslopes should be laid back to a stable angle, typically a 2:1 (50%) gradient, or less. Spoil can be endhailed off-site or stored on the road bench adjacent the crossing, provided it is placed and stabilized where it will not erode or fall and enter the stream.

BMP: Rolling Dip Design and Placement

- Rolling dips are drainage structures designed to force surface water to be drained from the road surface.
- The road shall dip into, and rise out of, the rolling dip to eliminate the potential of road surface runoff to run further down road way.
- The rolling dip shall be constructed with clean native materials or rock surfaced where specified.
- The rolling dips outlet may be armored to resist down-cutting and erosion of the outboard road fill.
- Do not discharge rolling dips into any areas that show signs of instability or active landsliding.
- If the rolling dip is designed to divert both road surface and ditch runoff, block the down-road ditch with compacted fill in order to force all ditch flows through the trough (low point) of the rolling dip.

BMP: Rocked Rolling Dip Design and Placement

- Rocked rolling dips are drainage structures designed to carry known sources of surface water across road ways or from known persistently wet segments of road such as swales without defined watercourses or road segments with heavy bank/road seepage.
- The road shall dip into, and rise out of, the rocked rolling dip to minimize diversion potential.
- The rocked rolling dip shall be constructed with clean rock that is large enough to remain in place during peak flows. Rock size shall vary relative to the anticipated flow through the dip with larger rock used in location where greater flow is anticipated.
- The rocked rolling dips inlet and outlet shall be armored to resist down-cutting and erosion.
- The entire width of the rocked rolling dip shall be rock armored to a minimum of 5-feet from the centerline of the dipped portion of the rolling dip.
- If a keyway is necessary, the rocked rolling dip keyway at the base of the dip shall be of sufficient size, depth and length to support materials used in the rocked rolling dip construction back up to the road crossing interface.
- Do not discharge rolling dips into any areas that show signs of instability or active landsliding.
- If the rolling dip is designed to divert both road surface and ditch runoff, block the down-road ditch with compacted fill.
- The rolling dip should be designed as a broad feature ranging from 10-100 feet long so that it is drivable by most types of vehicular traffic and not significantly inhibit traffic and road use.

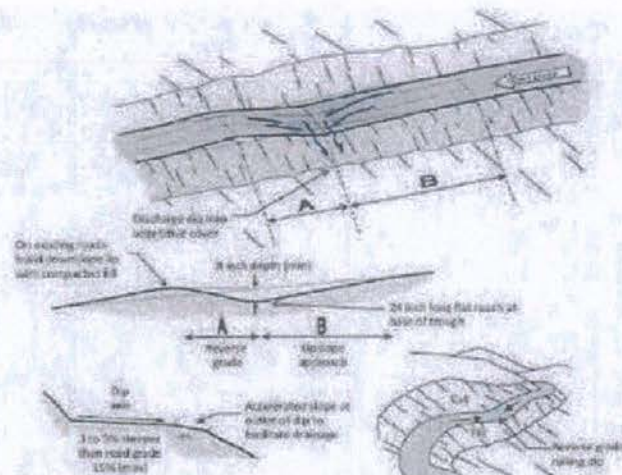
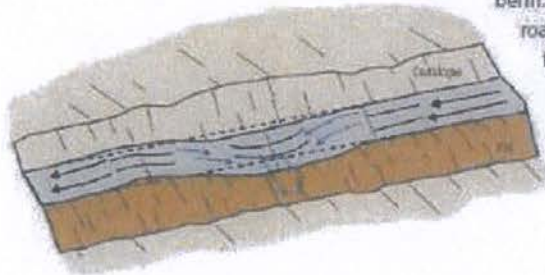


FIGURE 34. A classic Type I rolling dip, where the excavated up-road approach (B) to the rolling dip is several percent steeper than the approaching road and extends for 60 to 90 feet to the dip axis. The lower side of the structure reverses grade (A) over approximately 15 feet or more, and then falls down to regain the original road grade. The dip must be deep enough that it is not obliterated by normal grading, but not so deep that it is difficult to negotiate or a hazard to normal traffic. The outward cross-slope of the dip axis should be 3% to 5% greater than the up-road grade (B) so it will drain properly. The dip axis should be out-sloped sufficiently to be self-cleaning, without requiring excessive downcutting or sediment deposition in the dip axis (Modified from: Best, 2013).

HANDBOOK FOR FOREST, RANCH AND RURAL ROADS

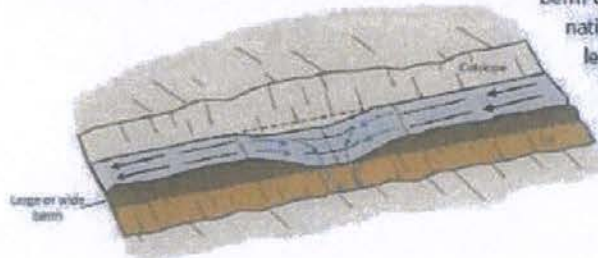
BMP: Rolling Dip Design and Placement (Types)

Type 1 Rolling Dip (Standard)



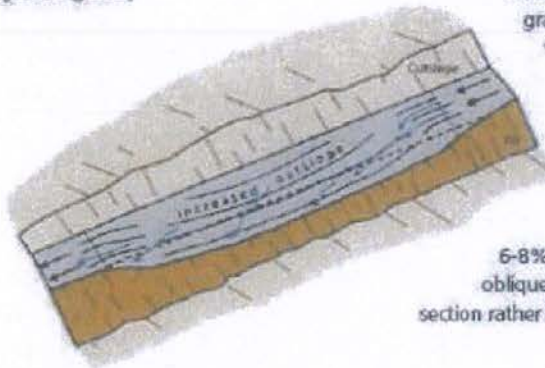
Type 1 rolling dips are used where road grades are less than about 12-14% and road runoff is not confined by a large through cut or berm. The axis of the dip should be perpendicular to the road alignment and sloped at 3-4% across the road tread. Steep roads will have longer and more abrupt dip dimensions to develop reverse grade through the dip axis. The road tread and/or the dip outlet can be rocked to protect against erosion, if needed.

Type 2 Rolling Dip (Through-cut or thick berm road reaches)



Type 2 rolling dips are constructed on roads up to 12-14% grade where there is a through cut up to 3 feet tall, or a wide or tall berm that otherwise blocks road drainage. The berm or native through cut material should be removed for the length of the dip, or at least through the axis of the dip, to the extent needed to provide for uninterrupted drainage onto the adjacent slope. The berm and slope material can be excavated and endhauled, or the material can be sidecast onto native slopes up to 45%, provided it will not enter a stream.

Type 3 Rolling Dip (Steep road grade)



Type 3 rolling dips are utilized where road grades are steeper than about 12% and it is not feasible to develop a reverse grade that will also allow passage of the design vehicle (steep road grades require more abrupt grade reversals that some vehicles may not be able to traverse without bottoming out).

Instead of relying on the dip's grade reversal to turn runoff off the roadbed, the road is built with an exaggerated outslope of 6-8% across the dip axis. Road runoff is deflected obliquely across the dip axis and is shed off the outsloped section rather than continuing down the steep road grade.

FIGURE 36. Rolling dip types

HANDBOOK FOR FOREST, RANCH AND RURAL ROADS

BMP: Rolling Dip Design and Placement

FIGURE 33A. Rolling dip constructed on a rock surfaced rural road. The rolling dip represents a change-in-grade along the road alignment and acts to discharge water that has collected on, or is flowing down, the road surface. This road was recently converted from a high maintenance, insloped, ditched road to a low maintenance, outsloped road with rolling dips.



FIGURE 33B. This side view of an outsloped road shows that the rolling dip does not have to be deep or abrupt to reverse road grade and effectively drain the road surface. This outsloped forest road has rolling dips that allow all traffic types to travel the route without changing speed.



BMP: Waterbar/Rolling Dip Combined with DRC



FIGURE 39.

Waterbars are often used to drain surface runoff from seasonal, unsurfaced roads. Because they are easily broken down by vehicles, waterbars are only used on unsurfaced roads where there is little or no wet weather traffic. In this photo, a waterbar and ditch relief culvert are used to drain all road surface and ditch runoff from the insloped road prism.

HANDBOOK FOR FOREST, RANCH AND RURAL ROADS

Diagram shows and discussed the use of a waterbar. However, a DRC combined with a rolling dip structure provides the same surface and ditch drainage for roads used year-round. Just as with the waterbar in the photo above, The DRC is installed just upslope from the rolling dip. This also creates a fail-safe should the DRC become plugged or overwhelmed.



FIGURE 238. Traffic and surface runoff from gravelled roads often produces surface erosion, turbid runoff and fine sediment transport that can be delivered to streams. Where ditches can't be eliminated, sediment traps and roadside setting basins can be installed to capture and remove most of the eroded sediment. This settling basin has been constructed along the inside ditch just before a stream crossing culvert inlet (see arrow). Eroded sediment from the road and ditch are deposited in the basin before flow is released to the stream. Fine sediments have filled about 1/3 of this basin and vegetation is now growing. Sediment basins require periodic maintenance to maintain their storage capacity.

HANDBOOK FOR FOREST, RANCH AND RURAL ROADS

BMP: Road Outsloping/Insloping



HANDBOOK FOR FOREST, RANCH, AND RURAL ROADS

FIGURE 29. Road shape changes as the road travels through the landscape. For example, an out-sloped road will have a steep or "banked" outslope through inside curves, a consistent outslope through straight reaches and a flat or slightly insloped shape as it goes through an outside curve. The road may have an outslope of 2-3% across the travel surface while the shoulder is more steeply outsloped to ensure runoff and sediment will leave the roadbed.

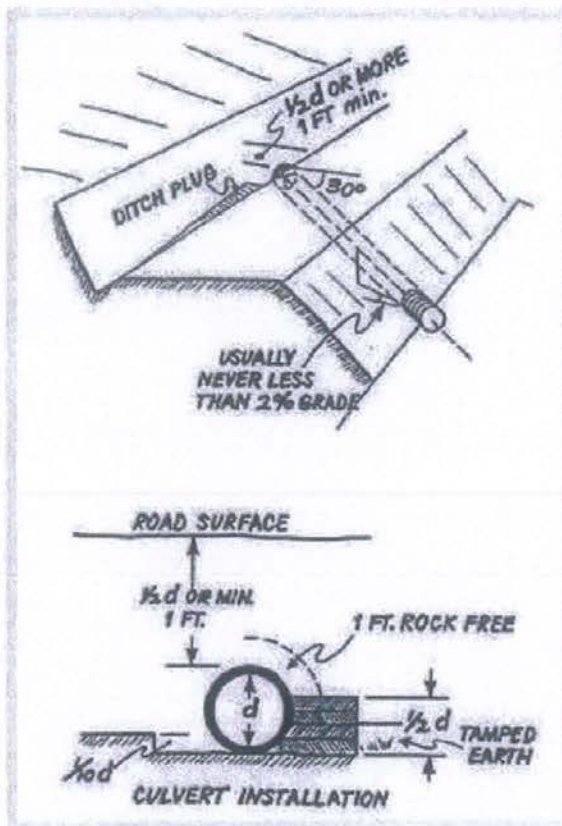
BMP: Steep Road Drainage Features

FIGURE 55. Steep roads that go straight up or down a hillside are very difficult to drain. This steep, fall line road developed a through cut cross section that was drained using lead out ditches to direct runoff off the road and onto the adjacent, vegetated hillside. The road was "outsloped" to drain runoff to the right side, and the lead out ditch was built slightly steeper than the road grade, to be self-cleaning. Four lead out ditches have been constructed at 100-foot intervals to the bottom of the hillside.

HANDBOOK FOR FOREST, RANCH AND RURAL ROADS

BMP: Ditch Relief Culvert

- Install ditch relief culverts at an oblique (typically 30 degree) angle to the road so that ditch flow does not have to make a sharp angle turn to enter the pipe. On low gradient roads (<5%), where ditch flow is slow, ditch relief culverts can be installed at right angles to the road.
- Install ditch relief culverts (DRC) to outlet at, and drain to, the base of the fill
- If it cannot be installed at the base of the fill, install the DRC with a grade steeper than the inboard ditch draining to the culvert inlet, and then install a downspout on the outlet to carry the culverted flow to the base of the fillslope or energy dissipater material at outlet to prevent erosion or the outboard road fill.
- Downspouts longer than 20 feet should be secured to the hillslope for stability.
- Ditch relief culverts should not carry excessive flow such that gulying occurs below the culvert outlet or such that erosion and down-cutting of the inboard ditch is occurring.
- Do not discharge flows from ditch relief culverts onto unstable areas or highly erodible hillslopes.
- If the ditch is on an insloped or crowned road, consider reshaping road outsloping to drain the road surface. The ditch and the ditch relief culvert would then convey only spring flow from the cutbank and hillslope runoff, and not turbid runoff from the road surface.



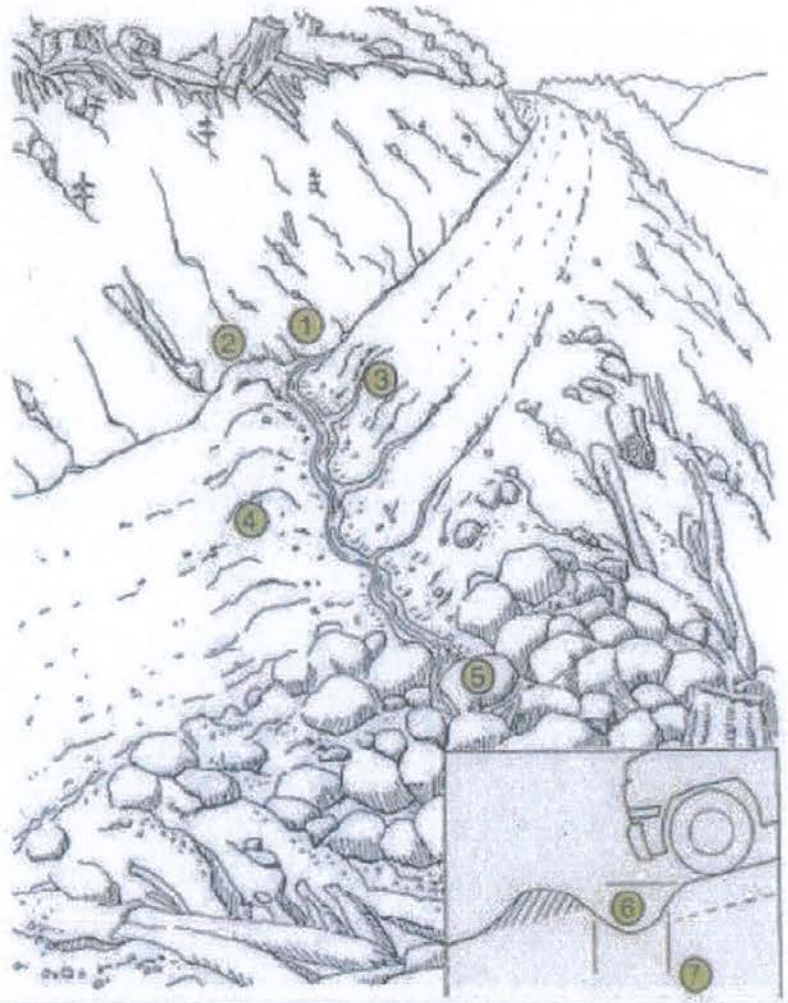
HANDBOOK FOR FOREST, RANCH AND RURAL ROADS

FIGURE 48. The elements of a properly installed ditch relief culvert. The culvert is angled at about 30 degrees to the road alignment to help capture flow and prevent culvert plugging or erosion of the inlet area. It is set at the base of the fill (ideally) or with a grade slightly steeper than the grade of the contributing ditch (but never with a grade less than 2 percent) (USDA-SCS, 1983). At a minimum, the grade of the ditch relief culvert should be sufficient to prevent sediment accumulation at the inlet or deposition within the culvert itself (it should be self-cleaning) (USDA-SCS, 1983).

BMP: Waterbar Construction

FIGURE 40. Waterbars are constructed on unsurfaced forest and ranch roads that will have little or no traffic during the wet season. The waterbar should be extended to the cutbank to intercept all ditch flow (1) and extend beyond the shoulder of the road. A berm (2) must block and prevent ditch flow from continuing down the road during flood flows. The excavated waterbar (3) should be constructed to be self-cleaning, typically with a 30° skew to the road alignment with the excavated material bermed on the downhill grade of the road (4). Water should always be discharged onto the downhill side on a stable slope protected by vegetation. Rock (shown in the figure) should not be necessary if waterbars are spaced close enough to prevent serious erosion. (5) The cross ditch depth (6) and width (7) must allow vehicle cross-over without destroying the function of the drain. Several alternate types of waterbars are possible, including one that drains only the road surface (not the ditch), and one that drains the road surface into the inside ditch (BCMF, 1991).

HANDBOOK FOR FOREST, RANCH, AND RURAL ROADS

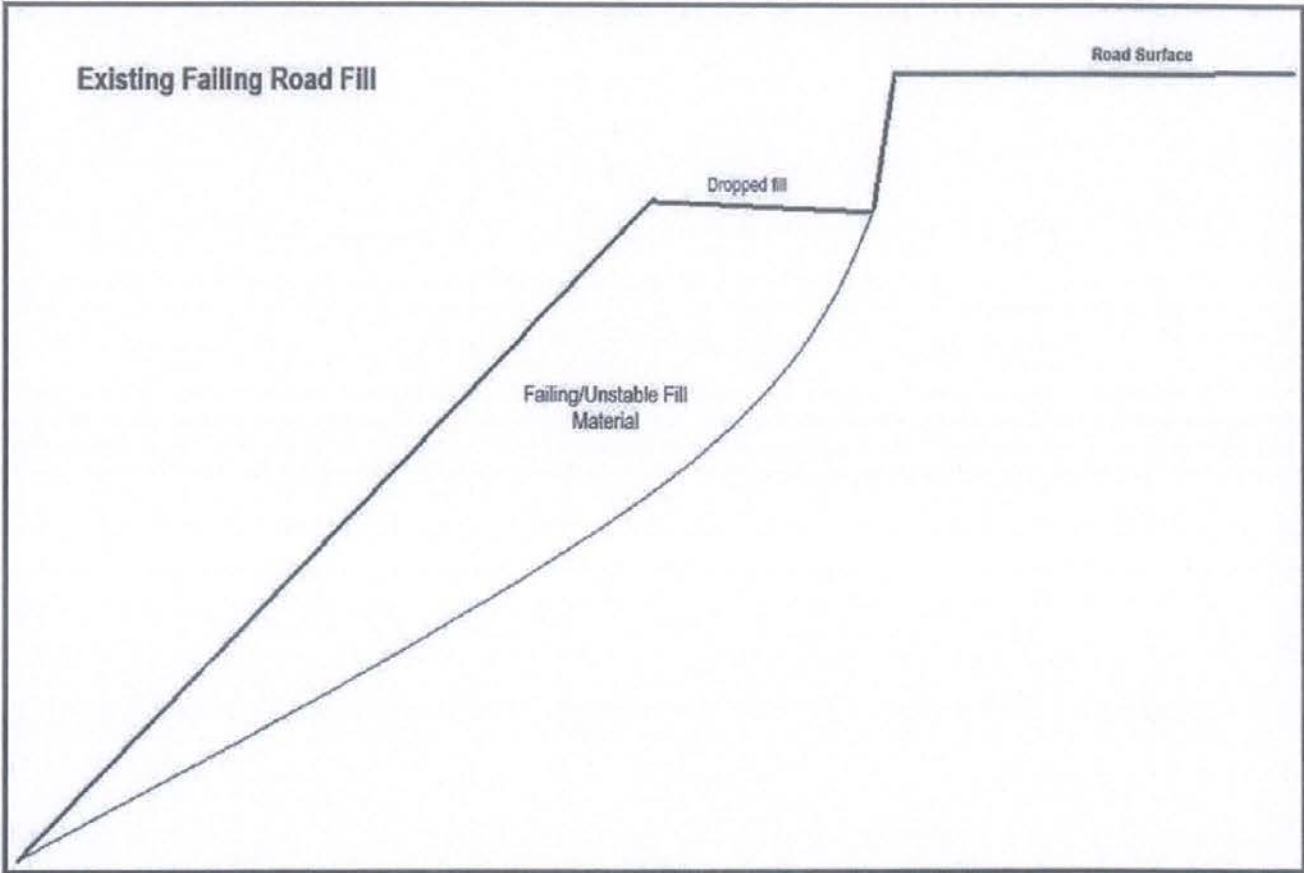


BMP: Unstable Fill Removal and Treatment

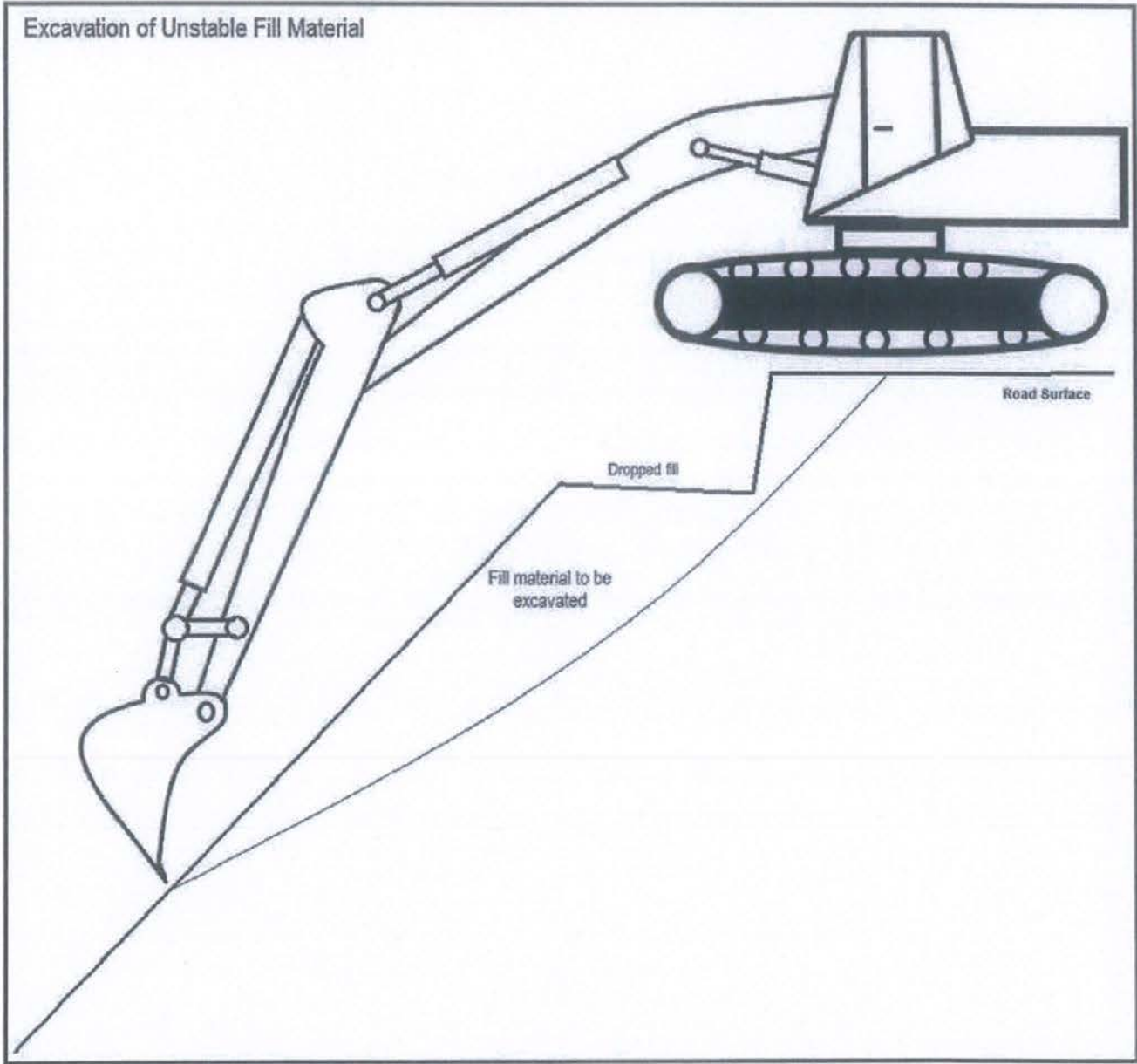


FIGURE 230. *The most cost-effective treatment for unstable fills along the outside of a forest, ranch or rural road is simply the direct excavation of the unstable material. If road width is too narrow, additional width can often be derived from cutting into the bank. The excavation should encompass the unstable fill materials, beginning at the inside crack or scarp, and extending out and down the fill slope as far as possible. For proper surface drainage, and to retrieve most of the unstable fill, the excavation should have a concave profile when completed. Typically, the bulk of the fill is within 20 to 25 feet of the outside edge of the road and is easily reached by a mid-sized excavator. Any remaining fill is likely to be small enough that it will not fail or travel far enough to reach the stream.*

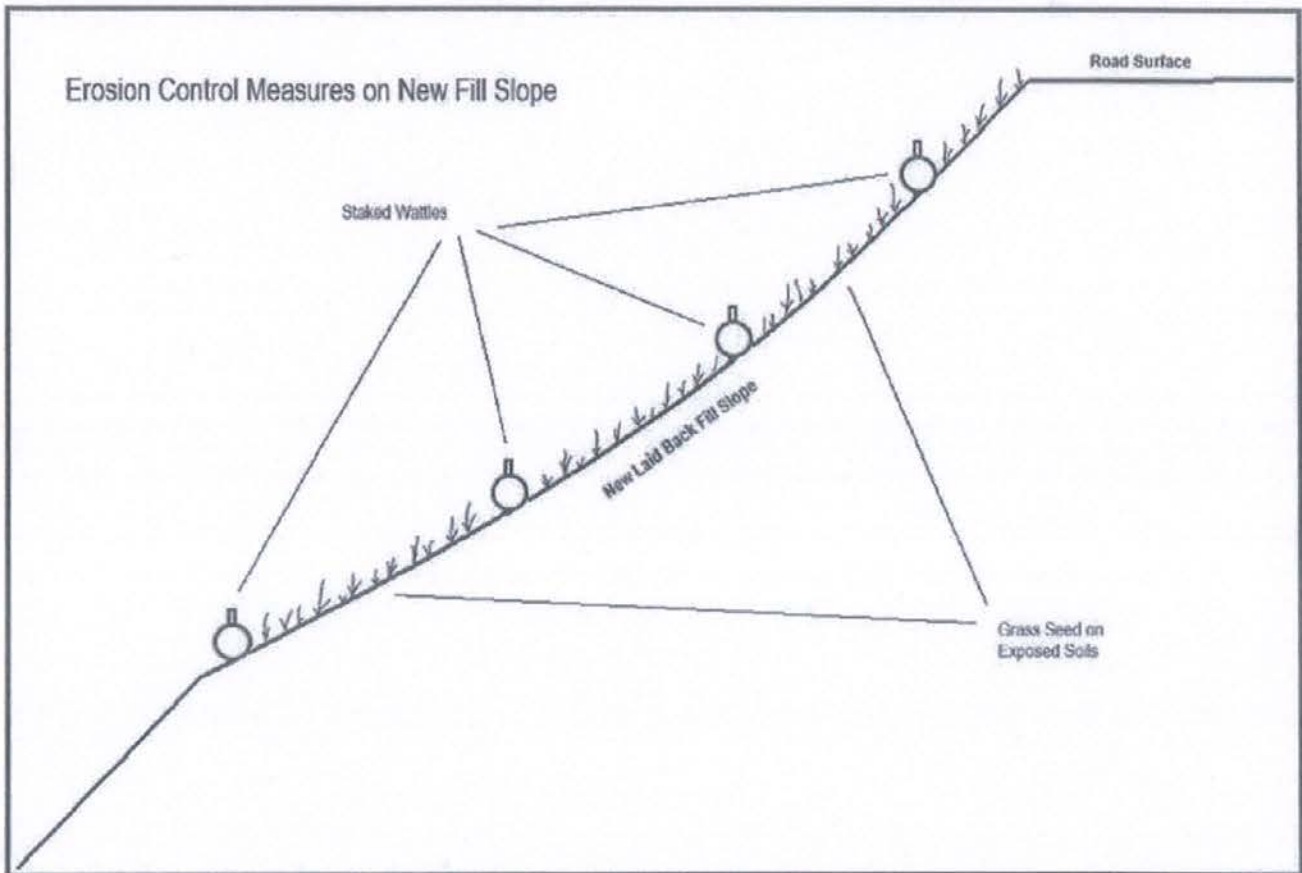
BMP: Unstable Fill Removal and Treatment



BMP: Unstable Fill Removal and Treatment



BMP: Unstable Fill Removal and Treatment



BMP: Rock Armor Cutbank



FIGURE 52. This wet and potentially unstable cut slope on a newly constructed road was stabilized using a buttress of large rock armor. To assure their effectiveness, rock buttresses and other retaining structures should be designed by a qualified engineer or engineering geologist.

HANDBOOK FOR FOREST, RANCH AND RURAL ROADS

BMP: Rip-Rap Size Class Table

TABLE 25. Standard classification and gradation of riprap by size of rock¹

Riprap size class	Median particle weight ²	Median particle diameter ² (in)	Minimum and maximum allowable particle size (in) ²							
			D ₁₅		D ₅₀		D ₈₅		D ₁₀₀	
			Min	Max	Min	Max	Min	Max	Max	
Class I	20 lb	6	3.7	5.2	5.7	6.9	7.8	9.2	12.0	
Class II	60 lb	9	5.5	7.8	8.5	10.5	11.5	14.0	18.0	
Class III	160 lb	12	7.3	10.5	11.5	14.0	15.5	18.5	24.0	
Class IV	300 lb	15	9.2	13.0	14.5	17.5	19.5	23.0	30.0	
Class V	¾ ton	18	11.0	15.5	17.0	20.5	23.5	27.5	36.0	
Class VI	3/8 ton	21	13.0	18.5	20.0	24.0	27.5	32.5	42.0	
Class VII	½ ton	24	14.5	21.0	23.0	27.5	31.0	37.0	48.0	
Class VIII	1 ton	30	18.5	26.0	28.5	34.5	39.0	46.0	60.0	
Class IX	2 ton	36	22.0	31.5	34.0	41.5	47.0	55.5	72.0	
Class X	3 ton	42	25.5	38.5	40.0	48.5	54.5	64.5	84.0	

¹Lagasse et al. (2006)

²Equivalent to spherical diameter

BMP: Storage Bladders

- Storage bladders shall be located and designed to minimize the potential for impacts due to rolling and/or failure. Storage bladders should be stored on flat slopes where stability will not be affected.
- Storage bladders shall be located to minimize the potential for water to flow into a watercourse in the event of a catastrophic failure.
- Bladders shall not be used unless the bladder is safely contained within a secondary containment system with sufficient capacity to capture 110 percent of a bladders maximum volume in the vent of bladder failure.
- Secondary containment is recommended in the form of a dirt berm, containment pit, combination of both, or impermeable material with skeletal support. The containment should be capable of holding 110 percent of the bladders volume.
- Secondary containment systems shall be of sufficient strength and stability to withstand the forces of released contents in the event of catastrophic bladder failure.
- Secondary containment systems that are exposed to precipitation shall be designed and maintained with sufficient capacity to accommodate precipitation and storm water inputs from a 25-year, 24-hour storm event.
- Bladders and containment systems shall be periodically inspected to ensure integrity.



This is an example of a containment pit which will assist in mitigating the impacts if this storage bladder failed.

BMP: Cultivation Site Restoration

- Remove all cultivation and associated materials from designated cultivation site.
 - This includes plant mass, root balls, potting containers, cultivation medium and any materials associated with the preparation, cultivation, and harvest of commercial cannabis.
 - Cultivation medium removed from the site shall be stored/disposed of in compliance with Order conditions related to spoils management.
- All disturbed and/or unstable slopes shall be stabilized and returned to pre-project conditions.
 - Slopes shall be contoured as close as feasible to natural grade and aspect.
 - Temporary erosion control shall be applied to prevent sediment run-off.
- Soil exposed as a result of project work, soil above rock riprap, and interstitial spaces between rocks shall be revegetated with native species by live planting, seed casting, or hydroseeding prior to the rainy season of the year work is completed.
 - Native plants characteristic of the local habitat shall be used for revegetation when implementing and maintaining cleanup/restoration work in riparian and other sensitive areas.
 - Native forbes and graminoids shall be planted to replace sediment stabilization, sediment filtration and nutrient filtration
 - Native trees and shrubs shall be planted to replace bank stabilization, inputs of large woody debris and temperature control within riparian areas.
 - Restoration of the quality/health of the riparian stand shall promote: 1) shade and microclimate controls; 2) delivery of wood to channels, 3) slope stability and erosion control, 4) ground cover, and 5) removal of excess nutrients.

Monitoring Plan

Cannabis cultivators shall regularly inspect and maintain the condition of access roads, access road drainage features, and watercourse crossings. At a minimum, cannabis cultivators shall perform inspections prior to the onset of fall and winter precipitation and following storm events that produce at least 0.5 in/day or 1.0 inch/7 days of precipitation. See Required Monitoring tables below for site specific monitoring and reporting requirements. Cannabis cultivators are required to perform all of the following maintenance:

- Remove any wood debris that may restrict flow in a culvert.
- Remove sediment that impacts access road or drainage feature performance.
- Place any removed sediment in a location outside the riparian setbacks and stabilize the sediment.
- Maintain records of access road and drainage feature maintenance for annual reporting.

Cannabis cultivators that are operating in areas that are, or may become, inaccessible during winter months due to extreme weather such as snow, road closures, seasonal access roads to the property, or any other such conditions shall make additional efforts to enhance winterization measures in the absence of monitoring during storm events.

Monitoring Requirements

(Tier 1, Moderate, < 1 acre of cultivation)

Monitoring Requirement	Description
Winterization Measures Implemented	Report winterization procedures implemented, any outstanding measures, and the schedule for completion.
Tier Status Confirmation	Report any changes in the tier status.
Third Party Identification	Report any change in third party status as appropriate.
Surface Water Runoff	Report any conditions of surface water runoff, including location, duration, source of runoff (irrigation water, storm water, etc.)
Soil Erosion Control	Report any indications of soil erosion (e.g. gullying, turbid water discharge, landslide, etc.)
Sediment Capture	Report the status of sediment capture measures (e.g. silt fence, fiber rolls, settling basin, etc.)
Erosion/Sediment Capture Maintenance	Report maintenance activities to maintain the effectiveness of erosion control and

	<p>sediment capture measures (e.g. reinstallation of straw mulch, hydroseeding, tarp placement, removal or stabilization of sediment captured, removal of settled sediment in a basin, etc.)</p>
Stabilization of Disturbed Areas	<p>Dischargers characterized as high risk (with any portion of the disturbed area within the riparian setbacks), shall provide a status report describing activities performed to stabilize the disturbed area within the setback</p>
Material(s) Storage Erosion/Spills Prevention	<p>Report materials delivered or stored at the site that could degrade water quality if discharged off-site (e.g. potting soil, manure, chemical fertilizer, gasoline, herbicides, pesticides, etc.)</p>
Holding Tank, Septic Tank, or Chemical Toilet Servicing	<p>Septic tank, or chemical toilet servicing report the dates, activity, and name of the servicing company for servicing holding tanks or chemical toilets</p>

Please note the following information for the table below:

1. Constituents shall be monitored with a calibrated instrument.
2. Samples shall be representative of storm water discharging from the disturbed area.
3. Monitoring shall be performed during all months in which activity is occurring at the site until winterization is complete. Monitoring is not required after winterization is complete for unoccupied sites during the winter months.

The following monitoring and reporting activities are required on a monthly basis for **ALL MONTHS** until winterization procedures are completed:

Constituent	Frequency
Turbidity	Once per calendar month when precipitation exceeds 0.25 in/day or when storm water runoff from the site is generated
pH	Once per calendar month when precipitation amount is forecast to exceed 0.25 in/day

Annual Reporting

Annual Reports shall be submitted to the North Coast Regional Water Quality Control Board by March 1st following the year being monitored. The first Annual Report for this enrollment shall be submitted by March 1st, 2021 and report on monitoring done during the 2020 calendar year. Annual reporting is required each subsequent year of enrollment.

Attachments

Implementation of Applicable BPTC Measures

Assessment of applicable BPTC measures consisted of a field examination on October 30th, 2019. Anywhere applicable BPTC measures are not met on the property, descriptions of the assessments and the prescribed treatments are outlined following each associated section below.

Summary of BPTC Measures Compliance

1. Sediment Discharge BPTC Measures Y/N
2. Fertilizer, Pesticide, Herbicide, and Rodenticide BPTC Measures Y/N
3. Petroleum Product BPTC Measures Y/N
4. Trash/Refuse, and Domestic Wastewater BPTC Measures Y/N
5. Winterization BPTC Measures Y/N

1. Sediment Discharge BPTC Measures

1.1. Site Characteristics

- 1.1.1. Provide a map showing access roads, vehicle parking areas, streams, stream crossings, cultivation site(s), disturbed areas, buildings, and other relevant site features.

See attached Site Map.

- 1.1.2. Describe the access road conditions including estimating vehicle traffic, road surface (e.g., paved, rocked, or bare ground), and maintenance activities. Describe how storm water is drained from the access road (e.g., crowned, out slope, armored ditch, culverts, rolling dips, etc.).

See sections "Land Development and Maintenance, Erosion Control, and Drainage Features" above, and the attached Mitigation Report, Site Maps, and Treatment Implementation Schedule for site specific descriptions, treatments, and the implementation schedule.

- 1.1.3. Describe any vehicle stream crossing including the type of crossing (e.g., bridge, culvert, low water, etc.).

No watercourse crossings were identified during the assessment of the property.

- 1.1.3.1. For Region 1 Dischargers, identify, discuss, and locate on the site map any legacy waste discharge issues that exist on the property.

Not applicable. No legacy waste discharge issues were identified during the assessment of the property.

- 1.2. Sediment Erosion Prevention and Sediment Capture (Moderate risk Tier 1 or Tier 2 Dischargers are required to submit a Site Erosion and Sediment Control Plan. Those Dischargers may refer to that plan rather than repeat it here)

1.2.1. Erosion Prevention BPTC Measures

- 1.2.1.1. Describe the BPTC measures that have been, or will be implemented to prevent or limit erosion. Provide an implementation schedule for BPTC measures that have not yet been implemented. Identify the erosion prevention BPTC measures on a site map.

See section "Land Development and Maintenance, Erosion Control, and Drainage Features", the attached Mitigation Report, Site Maps, and Treatment Implementation Schedule for site specific descriptions of physical BPTC measures being prescribed.

- 1.2.1.1.1. The description shall address physical BPTC measures, (e.g., placement of straw mulch, plastic covers, slope stabilization, soil binders, culvert outfall armoring, etc.) and biological BPTC measures (vegetation preservation/replacement, hydro seeding, etc.).

See the attached Mitigation Report and Best Management Practices (BMPs) for descriptions of physical BPTC measures being prescribed.

1.2.2. Sediment Control BPTC Measures

- 1.2.2.1. Describe the BPTC measures that have been, or will be implemented to capture sediment that has been eroded. Provide an implementation schedule for BPTC measures that have not yet been implemented. Identify the sediment control BPTC measures on a site map.

See the attached Mitigation Report (Site 06), Site Maps, and Treatment Implementation Schedule for site specific descriptions, treatments, and the implementation schedule.

- 1.2.2.1.1. The description shall address physical BPTC measures, (e.g., placement of silt fences, fiber rolls, or settling ponds/areas, etc.) and biological BPTC measures (vegetated outfalls, hydro seeding, etc.).

See section "Land Development and Maintenance, Erosion Control, and Drainage Features", and the attached Mitigation Report and BMPs for descriptions of physical BPTC measures being prescribed.

1.2.3. Maintenance Activities - Erosion Prevention and Sediment Control

- 1.2.3.1. Describe how the erosion prevention and sediment control BPTC measures will be monitored and maintained to protect water quality.

Erosion prevention BPTC measures and all corresponding work shall be inspected prior to and in conjunction with winter monitoring, as described above under the "Monitoring Plan" to ensure proper placement, installation, and function remain intact prior to and throughout the Winter Period.

- 1.2.3.2. Describe how any captured sediment will be either stabilized in place, excavated and stabilized on-site, or removed from the site.

Any significant captured sediment behind the wattles at Site 06 will be allowed to stabilize and vegetate in place. If the wattles become backfilled with debris and begin to overtop, they shall be cleared out. This debris from the wattles shall be contoured into the grass hillside downslope, away from any surface runoff. The wattles shall be replaced if they have degraded to the point that they no longer function as intended.

- 1.2.4. Erosion control BPTC measures: Describe the interim soil stabilization, if applicable and long-term BPTC measures implemented to prevent sediment transport at each identified disturbed area(s) and improperly constructed features.

Not applicable. There was no erosion observed at any of the disturbed areas and there are no improperly constructed features. Disturbed areas are located on gentle slopes surrounded by vegetation and grass buffers.

2. Fertilizer, Pesticide, Herbicide, and Rodenticide BPTC Measures

2.1. Provide a summary table that identifies the products used at the site, when they are delivered to the site, how they are stored, and used at the site. If products are not consumed during the growing season, describe how they are removed from the site or stored to prevent discharge over the winter season.

See comprehensive table under 2.3

2.2. Provide a site map that locates storage locations.

See attached Site Map. Fertilizers and soil amendments are currently stored properly within the shipping containers and sheds.

2.3. Describe how bulk fertilizers and chemical concentrates are stored, mixed, applied, and how empty containers are disposed.

Fertilizer, Pesticides, and Herbicide Products used on Site

Product	Delivery and Storage	On-site usage	How removed or stored
Advanced Nutrients Beastie Blooms	Brought to property as needed. Stored within the shipping containers and sheds with all other fertilizers and amendments over winter or alongside mixing tanks while in use. Stored alongside mixing tanks while in use.	Mixed into tank with water. It is then hand watered to plants as needed.	Stored within the storage structures over winter. Empty containers are disposed of at an appropriate waste disposal facility.
Advanced Nutrients Cha Ching	Brought to property as needed. Stored within the shipping containers and sheds with all other fertilizers and amendments over winter or alongside mixing tanks while in use. Stored alongside mixing tanks while in use.	Mixed into tank with water. It is then hand watered to plants as needed.	Stored within the storage structures over winter. Empty containers are disposed of at an appropriate waste disposal facility.
Eco Nutrients Liquid Bone Meal	Brought to property as needed. Stored within the shipping containers and sheds with all other fertilizers and amendments over winter or alongside mixing tanks while in use. Stored alongside mixing tanks while in use.	Mixed into tank with water. It is then hand watered to plants as needed.	Stored within the storage structures over winter. Empty containers are disposed of at an appropriate waste disposal facility.
General Hydroponics CaliMagic	Brought to property as needed. Stored within the shipping containers and sheds with all other fertilizers and amendments over winter	Mixed into tank with water. It is then hand watered to plants as needed.	Stored within the storage structures over winter. Empty containers are disposed of at an appropriate waste disposal facility.

	or alongside mixing tanks while in use. Stored alongside mixing tanks while in use.		
General Hydroponics Flora Nova Grow	Brought to property as needed. Stored within the shipping containers and sheds with all other fertilizers and amendments over winter or alongside mixing tanks while in use. Stored alongside mixing tanks while in use.	Mixed into tank with water. It is then hand watered to plants as needed.	Stored within the storage structures over winter. Empty containers are disposed of at an appropriate waste disposal facility.
General Hydroponics MaxiGro	Brought to property as needed. Stored within the shipping containers and sheds with all other fertilizers and amendments over winter or alongside mixing tanks while in use. Stored alongside mixing tanks while in use.	Mixed into tank with water. It is then hand watered to plants as needed.	Stored within the storage structures over winter. Empty containers are disposed of at an appropriate waste disposal facility.
Grow More Line of fertilizers	Brought to property as needed. Stored within the shipping containers and sheds with all other fertilizers and amendments over winter or alongside mixing tanks while in use. Stored alongside mixing tanks while in use.	Mixed into tank with water. It is then hand watered to plants as needed.	Stored within the storage structures over winter. Empty containers are disposed of at an appropriate waste disposal facility.
Humboldt Ag Supply Plant Nitrogen	Brought to property as needed. Stored within the shipping containers and sheds with all other fertilizers and amendments over winter or alongside mixing tanks while in use. Stored alongside mixing tanks while in use.	Mixed into tank with water. It is then hand watered to plants as needed.	Stored within the storage structures over winter. Empty containers are disposed of at an appropriate waste disposal facility.
MaxSea All purpose	Brought to property as needed. Stored within the shipping containers and sheds with all other fertilizers and amendments over winter or alongside mixing tanks while in use. Stored alongside mixing tanks while in use.	Mixed into tank with water. It is then hand watered to plants as needed.	Stored within the storage structures over winter. Empty containers are disposed of at an appropriate waste disposal facility.
MaxSea Bloom	Brought to property as needed. Stored within the shipping containers and sheds with all other fertilizers and amendments over winter or alongside mixing tanks while in use. Stored	Mixed into tank with water. It is then hand watered to plants as needed.	Stored within the storage structures over winter. Empty containers are disposed of at an appropriate waste disposal facility.

	alongside mixing tanks while in use.		
Sparetime Seaweed powder	Brought to property as needed. Stored within the shipping containers and sheds with all other fertilizers and amendments over winter or alongside mixing tanks while in use. Stored alongside mixing tanks while in use.	Mixed into tank with water. It is then hand watered to plants as needed.	Stored within the storage structures over winter. Empty containers are disposed of at an appropriate waste disposal facility.
Sparetime Supply Molasses	Brought to property as needed. Stored within the shipping containers and sheds with all other fertilizers and amendments over winter or alongside mixing tanks while in use. Stored alongside mixing tanks while in use.	Mixed into tank with water. It is then hand watered to plants as needed.	Stored within the storage structures over winter. Empty containers are disposed of at an appropriate waste disposal facility.
Shrimp Meal	Brought to property as needed. Stored within the shipping containers and sheds with all other fertilizers and amendments.	Amended into potting soils as needed.	Stored within the storage structures over winter. Empty containers are disposed of at an appropriate waste disposal facility.
Crab Meal	Brought to property as needed. Stored within the shipping containers and sheds with all other fertilizers and amendments.	Amended into potting soils as needed.	Stored within the storage structures over winter. Empty containers are disposed of at an appropriate waste disposal facility.
Feather Meal	Brought to property as needed. Stored within the shipping containers and sheds with all other fertilizers and amendments.	Amended into potting soils as needed.	Stored within the storage structures over winter. Empty containers are disposed of at an appropriate waste disposal facility.
Neem Seed Meal	Brought to property as needed. Stored within the shipping containers and sheds with all other fertilizers and amendments.	Amended into potting soils as needed.	Stored within the storage structures over winter. Empty containers are disposed of at an appropriate waste disposal facility.
Mocha Bat Guano	Brought to property as needed. Stored within the shipping containers and sheds with all other fertilizers and amendments.	Amended into potting soils as needed.	Stored within the storage structures over winter. Empty containers are disposed of at an appropriate waste disposal facility.
Bat Guano	Brought to property as needed. Stored within the shipping containers and sheds with all other fertilizers and amendments.	Amended into potting soils as needed.	Stored within the storage structures over winter. Empty containers are disposed of at an appropriate waste disposal facility.
Seabird Guano	Brought to property as needed. Stored within the shipping containers and sheds with all other	Amended into potting soils as needed.	Stored within the storage structures over winter. Empty containers are disposed of at an

	fertilizers and amendments.		appropriate waste disposal facility.
Kelp Meal	Brought to property as needed. Stored within the shipping containers and sheds with all other fertilizers and amendments.	Amended into potting soils as needed.	Stored within the storage structures over winter. Empty containers are disposed of at an appropriate waste disposal facility.
Alfalfa Meal	Brought to property as needed. Stored within the shipping containers and sheds with all other fertilizers and amendments.	Amended into potting soils as needed.	Stored within the storage structures over winter. Empty containers are disposed of at an appropriate waste disposal facility.

2.4. Describe procedures for spill prevention and cleanup.

Pesticides and liquid fertilizer containers are stored within a covered structure, within secured containers, with their lids secured after their use. The cannabis cultivator shall obtain adequate quantities of absorbent materials and ensure that they are stored at all locations where the materials above are used, stored, or mixed. Should a spill of these materials occur, absorbent materials will be applied immediately and allowed enough time to absorb as much material as possible. Following treatment, absorbent materials applied will be removed and disposed of appropriately as per the manufacturer's guidelines.

3. Petroleum Product BPTC Measures

3.1. Provide a summary table that identifies the products used at the site, when they are delivered to the site, how they are stored, and used at the site. If products are not consumed during the growing season, describe how they are removed from the site or stored to prevent discharge over the winter season.

See comprehensive table under 3.3.

3.2. Provide a site map that locates storage locations.

See attached Site Map.

3.3. Describe how fuels, lubricants, and other petroleum products are stored, mixed, applied, and empty containers are disposed.

Petroleum Products

Products used on site	When they are delivered to site	How they are stored and used	How removed or stored
Gasoline	Brought to site when needed throughout the year.	Stored in standard 5-gallon gasoline canisters in or underneath the shipping container shed. Used to fuel equipment.	Stored in standard 5-gallon gasoline canisters in or underneath the shipping container shed.
Motor oil	Brought to site when needed throughout the year.	Stored in or under the shipping container shed. Used to lubricate internal combustion engines.	After oil changes, the used motor oil is stored in either the container it came in or in sealed 5-gallon buckets for later disposal at an appropriate waste disposal facility.

3.4. Describe procedures for spill prevention and cleanup.

Any/all fuel canisters, motor oil containers, and generators, large or small, shall be stored in secondary containment (e.g. drip pans, plastic totes, or sealed metal boxes) while being stored long term or not in immediate use, wherever these materials are used anywhere on the property. Adequate quantities of absorbent materials are stored at all locations where these types of materials are used, stored, or mixed. Should a spill of these materials occur, absorbent materials will be applied immediately and allowed enough time to absorb as much material as possible. Following treatment, absorbent materials applied as well as any contaminated soil will be removed and disposed of appropriately for the spilled material.

4. Trash/Refuse, and Domestic Wastewater BPTC Measures

- 4.1. Describe the types of trash/refuse that will be generated at the site. Describe how the material is contained and properly disposed of.

Domestic and commercial cannabis refuse will be generated at the site. The refuse is securely stored in trash bags, trash bins, and a utility trailer at the cultivation areas, residences, and within a contained refuse storage shed adjacent to the residences prior to disposal at an appropriate waste disposal facility.

- 4.1.1. Provide a site map that locates the trash/refuse storage locations.

Refuse is stored in trash bags, trash bins, and a utility trailer at mapped cultivation areas and the houses. See attached Site Map.

- 4.2. Describe the number of employees, visitors, or residents at the site.

There are two regular employees who are at the site during the cultivation season. Additional employees are brought onto the property for short periods of time to complete projects requiring additional employees. Visitors are occasionally on site, including consultants and regulatory agencies. There is also a full-time residence on the property as well.

- 4.2.1. Describe the types of domestic wastewater generated at the site (e.g., household generated wastewater or chemical toilet).

Domestic sewage and wastewater (greywater) are generated on site.

- 4.2.2. Describe how the domestic wastewater is disposed.

- 4.2.2.1. Permitted onsite wastewater treatment system (e.g., septic tank and leach lines).

Domestic sewage is disposed via a permitted septic system.

- 4.2.2.2. Chemical toilets or holding tank. If so, provide the name of the servicing company and the frequency of service.

Bread and Butter Portables provides and services one chemical toilet during the cultivation season. The facility is serviced as needed.

- 4.2.2.3. Outhouse, pit privy, or similar. Use of this alternative requires approval from the Regional Water Board Executive Officer; include the approval from the Executive Officer and any conditions imposed for use of this alternative.

Not applicable.

- 4.2.2.3.1. Provide a site map that locates any domestic wastewater treatment, storage, or disposal area.

See attached Site Map for locations of residences with attached septic. The chemical toilet is located nearby the northeastern shed on the property.

Site Erosion and Sediment Control Plan

(Tier 1, Moderate Risk)

1. Site Description

- 1.1. Describe the site (e.g., topography, vegetation, elevation, historic precipitation patterns, soil types, surface waterbodies, etc.).

See the Property Description, Project Description, General Location Map, Stream Crossing Installation and Maintenance for historic precipitation patterns, Site Maps, Overview Maps (if included), in the above pages.

- 1.2. Site Disturbances – Provide a site map that shows the location of all of the applicable following items. For each mapped item, provide a description of the item.

See the attached Site Map, General Location Map, Overview Maps (if included), in the above pages.

- 1.2.1. Historic (Existing) Disturbances (e.g., access/site roads, buildings, stream crossings, disturbed areas, graded areas, cultivation areas, vehicle parking areas, disturbed vegetation areas, etc.).

See the attached Site Map, General Location Map, Overview Maps (if included), in the above pages.

- 1.2.2. Recent or Planned Disturbances (e.g., access/site roads, buildings, disturbed areas, graded areas, cultivation areas, vehicle parking areas, vegetation removal areas, etc.).

See the “Project Description” section, “Land Development and Maintenance, Erosion Control, and Drainage Features” section, the attached Site Map, General Location Map, Overview Maps (if included), in the above pages. There are no plans to remove any vegetation for this project.

- 1.2.3. Areas of Special Concern (e.g., describe any existing or planned stream or wetland crossing, any culverts, any slope that shows evidence of past failure, or evidence of instability (e.g., cracks in retaining walls, surface cracks in soil, bulging soil, groundwater discharge areas, sunken road beds, downslope leaning trees or utility poles, etc.).

There were no Areas of Special Concern found on the property.

- 1.2.4. Describe and show on the site map, the storm water runoff sampling locations.

Storm water runoff sampling locations shall be determined during the first winter site visit, after the first major storm when storm runoff is most apparent.

1.3. Erosion Prevention BPTC Measures

- 1.3.1. Describe the BPTC measures that have been, or will be implemented to prevent or limit erosion. Provide an implementation schedule for BPTC measures that have not yet been implemented. Identify the erosion prevention BPTC measures on a site map.

See section "Land Development and Maintenance, Erosion Control, and Drainage Features", the attached Mitigation Report, Site Maps, and Treatment Implementation Schedule for site specific descriptions of physical BPTC measures being prescribed.

- 1.3.1.1. The description shall address physical BPTC measures, (e.g., placement of straw mulch, plastic covers, slope stabilization, soil binders, culvert outfall armoring, etc.) and biological BPTC measures (vegetation preservation/replacement, hydro seeding, etc.).

See the attached Mitigation Report and Best Management Practices (BMPs) for descriptions of physical BPTC measures being prescribed.

1.4. Sediment Control BPTC Measures

- 1.4.1. Describe the BPTC measures that have been, or will be implemented to capture sediment that has been eroded. Provide an implementation schedule for BPTC measures that have not yet been implemented. Identify the sediment control BPTC measures on a site map.

See the attached Mitigation Report (Site 06), Site Maps, and Treatment Implementation Schedule for site specific descriptions, treatments, and the implementation schedule.

- 1.4.1.1. The description shall address physical BPTC measures, (e.g., placement of silt fences, fiber rolls, or settling ponds/areas, etc.) and biological BPTC measures (vegetated outfalls, hydro seeding, etc.).

See section "Land Development and Maintenance, Erosion Control, and Drainage Features", and the attached Mitigation Report and BMPs for descriptions of physical BPTC measures being prescribed.

1.5. Maintenance Activities - Erosion Prevention and Sediment Control

- 1.5.1. Describe how the erosion prevention and sediment control BPTC measures will be monitored and maintained to protect water quality.

Erosion prevention BPTC measures and all corresponding work shall be inspected prior to and in conjunction with winter monitoring, as described above under the "Monitoring Plan" to ensure proper placement, installation, and function remain intact prior to and throughout the Winter Period.

- 1.5.2. Describe how any captured sediment will be either stabilized in place, excavated and stabilized on-site, or removed from the site.

Any significant captured sediment behind the wattles will be allowed to stabilize and vegetate in place. If the wattles become backfilled with debris and begin to overtop, they shall be cleared out. This debris from the wattles shall be contoured into areas in locations that are outside of the riparian setbacks with low gradient slopes, that do not deliver to Waters of the State. The Cultivator shall seed and mulch the spoils pile until adequately revegetated. The wattles shall be replaced if they have degraded to the point that they no longer function as intended.

2. Winterization

2.1. Prevention

- 2.1.1. Describe the BPTC measures that will be implemented before winter precipitation occurs to prevent erosion of disturbed areas, including the cultivation area.

See Mitigation Report and Annual Winterization Measures for prescribed general winterization measures that will be performed prior to each Winter Period, and site-specific interim measures that will be performed prior to the Winter Period until permanent, prescribed treatments can be executed.

- 2.1.2. Describe maintenance of all drainage or sediment capture features (e.g., drainage culverts, drainage trenches, settling ponds, etc.) to remove debris, soil blockages, and ensure adequate capacity exists.

See Section 1.5. above.

- 2.1.3. Describe any revegetation activities that will occur either at the beginning or end of the precipitation season.

Not applicable.

Photographs

Photo Dates: October 30th, 2020



Photo looking down grade at Site 01. A ditch relief culvert will be installed here. The inlet will be at the flagging as seen in the photo.



Photo looking at the inlet of the ditch crossing at Site 02. The inlet of this ditch crossing will be cleared.



Photo looking up grade at Site 06. Staked straw wattles will be installed across the inside ditch to capture sediment eroding away from a cutbank slump.



Photo looking up grade at Site 06.



Photo looking up grade at Site 07 where the inlet of a ditch relief culvert will be installed.



Photo looking down grade from Site 07 towards Site 06. A ditch relief culvert will be installed here, behind the taker of the photograph.



Photo looking down at Site 08. The inside ditch will be cleared from here to the inlet of the ditch relief culvert at Site 09.



Photo looking up grade from Site 08. The inside ditch will be cleared from here to the inlet of the ditch relief culvert at Site 09.



Photo of Site 10 looking up grade towards Site 15. The road will be rock surfaced here up to Site 13.



Photo of Site 10 looking up grade towards Site 12. The road will be rock surfaced here up to Site 13.



Photo looking up grade at Site 12 with Site 13 further up grade. The road surface will be rock surfaced from here up grade to Site 13.



Photo of the ditch relief culvert at Site 12. The inlet and outlet of the ditch relief culvert will be cleared of perched fill, the outlet will be rock armored, and the inside ditch draining to the inlet will be re-established.



Photo of the outlet at the ditch relief culvert at Site 12. The perched fill will be removed, the banks along the outlet trench laid back, and the outlet are will be cleared and rock armored.



Photo of the inlet of the ditch relief culvert at Site 12. The berm along the inlet of the ditch relief culvert will be cleared and re-established.



Photo looking down grade at Site 13. The rolling dip here will be re-established so that it functions and isn't bypassed by surface runoff. The rolling dip will then be rock surfaced.



Photo looking up grade at Site 14. The rolling dip here will be re-established so that it functions and isn't bypassed by surface runoff. The rolling dip will then be rock surfaced.



Photo looking up grade at Site 15. A waterbar will be installed here.



Photo looking up grade at Site 16. A waterbar will be installed here.